

## User's Guide

### SIBTF10xx-1xx-MR & SIBTF10xx-1xx-MS Substation-Rated Industrial Ethernet Switch

- 10/100Base-TX to 100Base-FX
- Single or Redundant Wide Input Power Supply

The SIBTF10xx-1xx-Mx Ethernet industrial switches allow connecting 10Base-T Ethernet/100Base-TX fast Ethernet twisted-pair copper network devices to network devices on a 100Base-FX fast Ethernet fiber network.

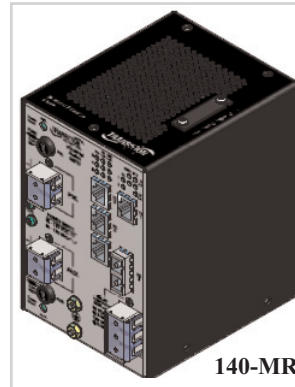

**140-MR**

The SIBTF10xx-140-MR has four RJ-45 copper ports and one fiber port. The SIBTF10xx-140-MR model includes redundant power-supply terminal blocks that can handle 48–170VDC or 90–125VAC, 50/60Hz input power. The SIBTF10xx-140-MS model, not shown, has a single power-supply terminal block (TB).

The SIBTF10xx-130-MR has three RJ-45 copper ports and two fiber ports. The SIBTF10xx-130-MR model includes redundant power-supply terminal blocks that can handle 48–170VDC or 90–125VAC, 50/60Hz input power. The SIBTF10xx-130-MS model, not shown, has a single power-supply terminal block (TB).

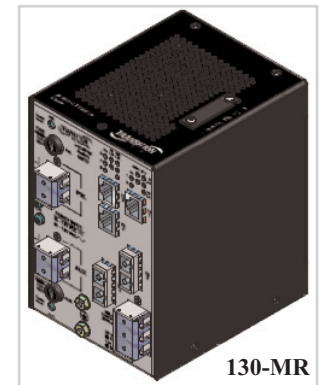

**130-MR**

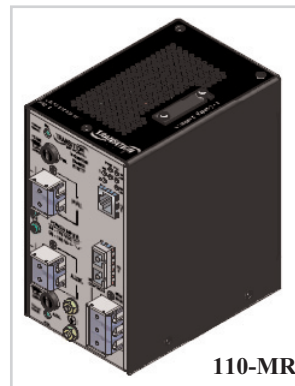

**110-MR**

The SIBTF10xx-110-MR has one RJ-45 copper port and one fiber port. The SIBTF10xx-110-MR model includes redundant power-supply terminal blocks that can handle 48–170VDC or 90–125VAC, 50/60Hz input power. The SIBTF10xx-110-MS model, not shown, has a single power-supply terminal block (TB).

Available Models	. . . . . 2
Installation	. . . . . 4
Operation	. . . . . 15
Cable Specifications	. . . . . 20
Technical Specifications	. . . . . 22
Troubleshooting	. . . . . 24
Contact Us	. . . . . 26
Compliance Information	. . . . . 27

## Available Models

### Available SIBTF10xx-140-MR and MS models\*

Part Number	(4) Copper - 10Base-T/ 100Base-TX ports	(1) Duplex Fiber-Optic - 100Base-FX port
<b>SIBTF1011-140-Mx</b>	RJ-45 100 m (328 ft)	ST, 1300 nm multimode, duplex 2 km (1.2 miles)
<b>SIBTF1013-140-Mx</b>	RJ-45 100 m (328 ft)	SC, 1300 nm multimode, duplex 2 km (1.2 miles)
<b>SIBTF1014-140-Mx</b>	RJ-45 100 m (328 ft)	SC, 1310 nm single mode, duplex 20 km (12.4 miles)
<b>SIBTF1015-140-Mx</b>	RJ-45 100 m (328 ft)	SC, 1310 nm single mode, duplex 40 km (24.8 miles)
<b>SIBTF1016-140-Mx</b>	RJ-45 100 m (328 ft)	SC, 1310 nm single mode, duplex 60 km (37.2 miles)
<b>SIBTF1017-140-Mx</b>	RJ-45 100 m (328 ft)	SC, 1550 nm single mode, duplex 80 km (49.7 miles)

\*MR = Redundant power-supply terminal blocks, MS = Single power-supply terminal block.

**Note:** The cable distances listed are maximum distances typically. The actual distance is dependent upon the physical characteristics of the network.

### Available SIBTF10xx-130-MR and MS models\*

Part Number	(3) Copper - 10Base-T/ 100Base-TX Ports	(2) Duplex Fiber-Optic - 100Base-FX Ports
<b>SIBTF1011-130-Mx</b>	RJ-45 100 m (328 ft)	ST, 1300 nm multimode, duplex 2 km (1.2 miles)
<b>SIBTF1013-130-Mx</b>	RJ-45 100 m (328 ft)	SC, 1300 nm multimode, duplex 2 km (1.2 miles)
<b>SIBTF1014-130-Mx</b>	RJ-45 100 m (328 ft)	SC, 1310 nm single mode, duplex 20 km (12.4 miles)
<b>SIBTF1015-130-Mx</b>	RJ-45 100 m (328 ft)	SC, 1310 nm single mode, duplex 40 km (24.8 miles)
<b>SIBTF1016-130-Mx</b>	RJ-45 100 m (328 ft)	SC, 1310 nm single mode, duplex 60 km (37.2 miles)
<b>SIBTF1017-130-Mx</b>	RJ-45 100 m (328 ft)	SC, 1550 nm single mode, duplex 80 km (49.7 miles)

\*MR = Redundant power-supply terminal blocks, MS = Single power-supply terminal block.

**Note:** The cable distances listed are maximum distances typically. The actual distance is dependent upon the physical characteristics of the network.

## Available Models -- continued

### Available SIBTF10xx-110-MR and MS models\*

Part Number	(1) Copper - 10Base-T/ 100Base-TX Port	(1) Duplex Fiber-Optic - 100Base-FX Port
<b>SIBTF1011-110-Mx</b>	RJ-45 100 m (328 ft)	ST, 1300 nm multimode, duplex 2 km (1.2 miles)
<b>SIBTF1013-110-Mx</b>	RJ-45 100 m (328 ft)	SC, 1300 nm multimode, duplex 2 km (1.2 miles)
<b>SIBTF1014-110-Mx</b>	RJ-45 100 m (328 ft)	SC, 1310 nm single mode, duplex 20 km (12.4 miles)
<b>SIBTF1015-110-Mx</b>	RJ-45 100 m (328 ft)	SC, 1310 nm single mode, duplex 40 km (24.8 miles)
<b>SIBTF1016-110-Mx</b>	RJ-45 100 m (328 ft)	SC, 1310 nm single mode, duplex 60 km (37.2 miles)
<b>SIBTF1017-110-Mx</b>	RJ-45 100 m (328 ft)	SC, 1550 nm single mode, duplex 80 km (49.7 miles)

\*MR = Redundant power-supply terminal blocks, MS = Single power-supply terminal block..

**Note:** The cable distances listed are maximum distances typically. The actual distance is dependent upon the physical characteristics of the network.

# Installation

## Features

- The SIBTF10xx-140-MR industrial switch includes four (4) RJ-45, twisted-pair copper ports and one (1) 100 Mb fiber optic port.
- The Auto-Negotiation feature on port “1” can be turned OFF and forced to a selected speed (*100 Mb/s or 10 Mb/s*) also duplex mode (*full or half*).
- All SIBTF models include a primary input terminal block (TB) for 48–170VDC or 90–125VAC power, a 2.5A, 250V fuse, an LED power indicator, and a red-fault LED. The red-fault LED “ON state” indicates the microcontroller did not initialize correctly.
- The “MR” models include an auxiliary power-supply terminal block—not available on “MS” models.

See Figure 1.

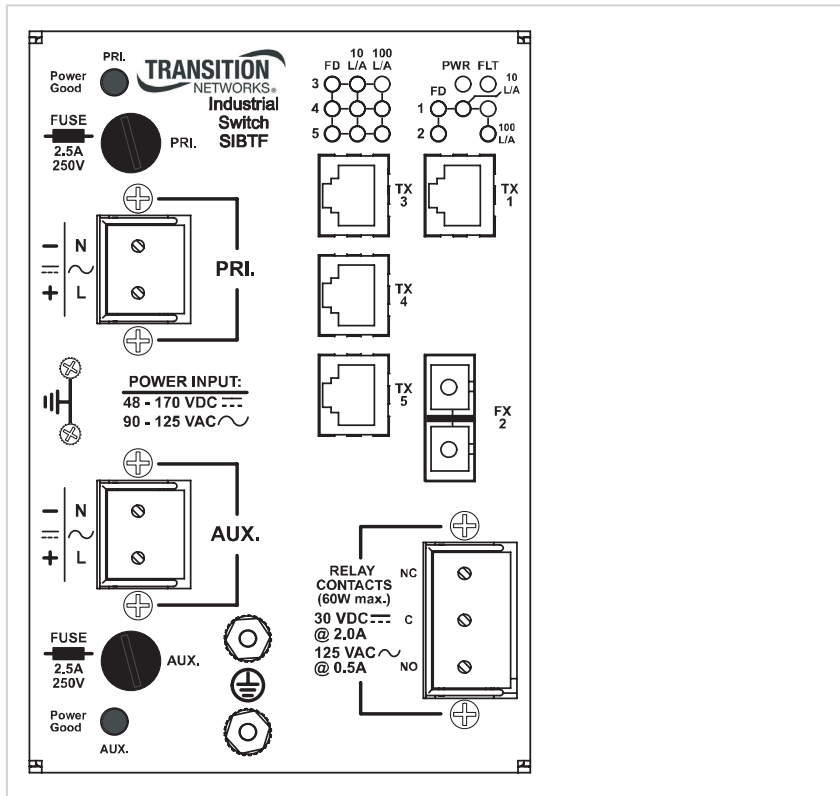

Figure 1: SIBTF10xx-140-MR Front Panel

# Installation -- continued

## Features -- continued

- The SIBTF10xx-130-MS industrial switch includes three (3) RJ-45, twisted-pair copper ports and one (2) 100 Mb fiber optic port.
- The Auto-Negotiation feature on port “1” can be turned OFF and forced to a selected speed (*100 Mb/s or 10 Mb/s*) and duplex mode (*full or half*).
- All SIBTF models include a primary input terminal block (TB) for 48–170VDC or 90–125VAC input power power, a 2.5A, 250V fuse, an LED power indicator, and a red-fault LED. The red-fault LED “ON state” indicates the microcontroller did not initialize correctly.
- The “MR” models include an auxiliary power-supply terminal block—not available on “MS” models.

See Figure 2.

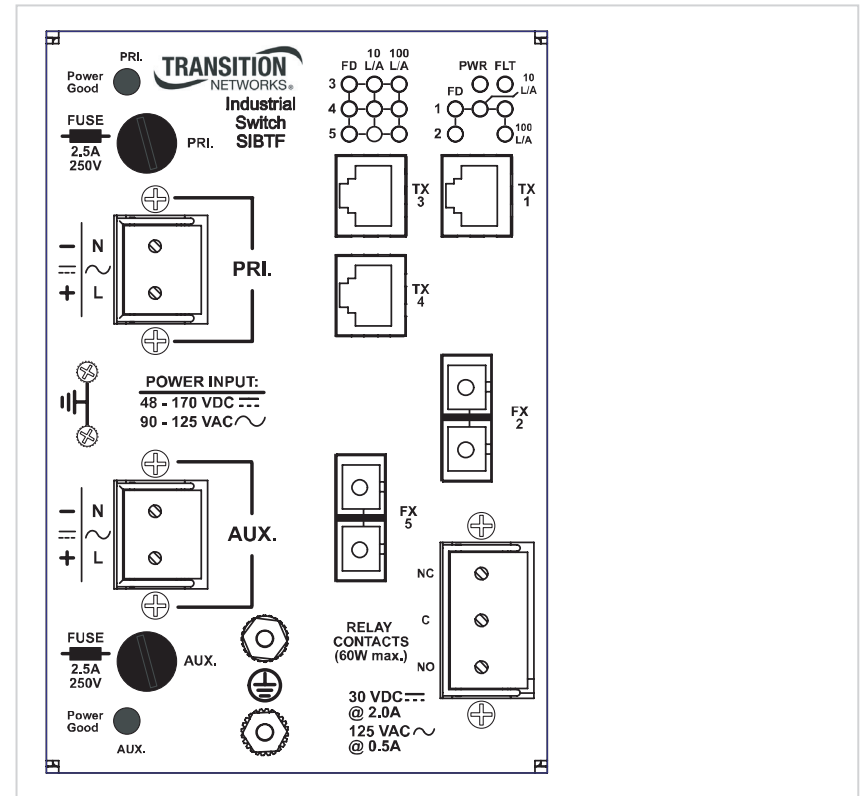

Figure 2: SIBTF10xx-130-MR Front Panel

## Installation -- continued

### Features -- continued

- The SIBTF10xx-110-MS industrial switch includes one (1) RJ-45, twisted-pair copper port and one (1) 100 Mb fiber optic port.
- The Auto-Negotiation feature on port “1” can be turned OFF and forced to a selected speed (*100 Mb/s or 10 Mb/s*) and duplex mode (*full or half*).
- All SIBTF models include a primary input terminal block (TB) for 48–170VDC or 90–125VAC power, a 2.5A, 250V fuse, an LED power indicator, and a fault LED. The red-fault LED “ON state” indicates the microcontroller did not initialize correctly.
- The “MR” models include an auxiliary power-supply terminal block—not available on “MS” models.

See Figure 3.

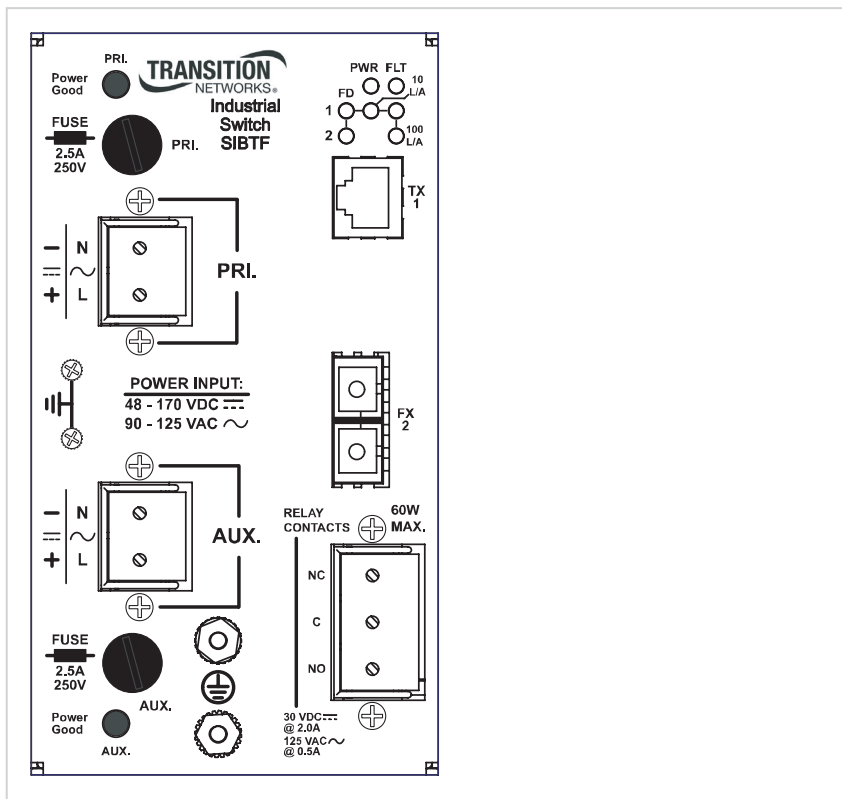

Figure 3: SIBTF10xx-110-MR Front Panel

## Installation -- continued

### Enclosure top view (configuration switches)

The SIBTF10xx-1xx-Mx has eight (8) configuration (DIP) switches located under the switch cover on top of the enclosure. See Figure 4.

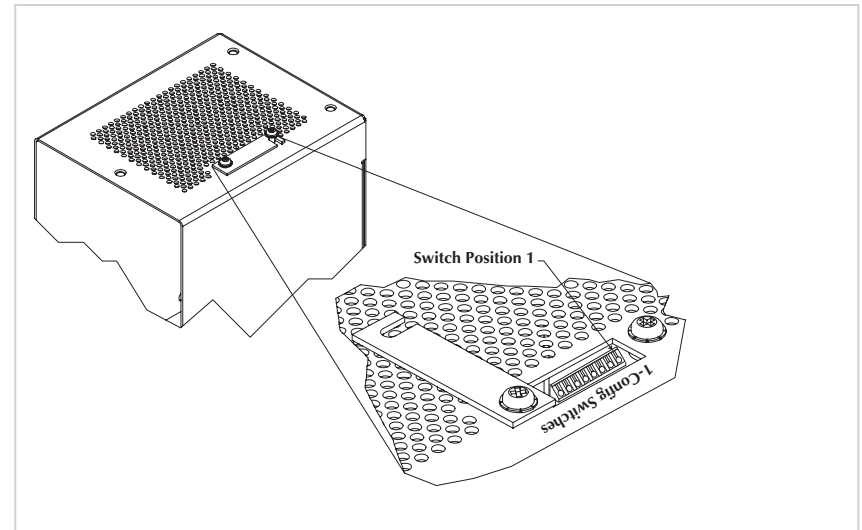

Figure 4: Enclosure Top View Configuration Switches

### Setting configuration switches

To set the DIP switches:

1. Using a small, phillips-head screwdriver, loosen (*do not remove*) the two screws that secure the cover to the switch.
2. Swing the switch cover counter-clockwise to expose the DIP switches.
3. Use a small, flathead screwdriver to set the recessed switches as required by the network application.\*
4. Slide the switch cover back over the DIP switches and then secure it by tightening both screws.

\***Note:** Switches 1, 2, and 3 apply only to twisted-pair “copper port #1.”

## Installation -- continued

### DIP switch settings

#### 1. Port 1 copper Auto-Negotiation:

UP (*Enabled*) - Advertises switch speed and mode capabilities to the network:

- 100Mb/s full-duplex • 100Mb/s half-duplex,
- 10Mb/s full-duplex • 10Mb/s half-duplex.

DOWN (*Disabled*) - Does not advertise switch speed and mode capabilities to the network. With Auto-Negotiate disabled switches 2 and 3 are used to set the twisted-pair speed and mode.

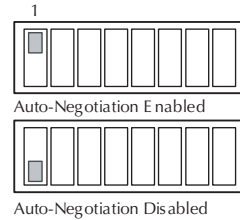

#### 2. Port 1 copper speed:

UP (*100Base-TX*) - Sets the twisted-pair speed to 100Base-TX.

DOWN (*10Base-T*) - Sets the twisted-pair speed to 10Base-T.

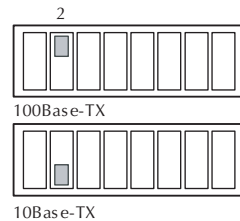

#### 3. Port 1 copper duplex:

UP (*Full-Duplex*) - The twisted-pair cable distances are constrained by the cable requirements.

DOWN (*Half-Duplex*): - The twisted-pair cable distances are constrained by the 512-Bit Rule.

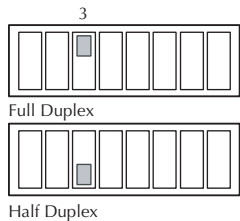

#### 4. Fiber port FX 1 duplex:

UP (*Full-Duplex*) - The cable distances for the fiber port are constrained by the cable requirements.

DOWN (*Half-Duplex*) - The cable distances for the fiber port are constrained by the 512-Bit Rule.

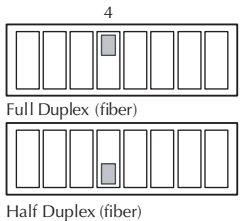

#### 5. Fiber port FX 2 duplex (*model 130 only*):

UP (*Full-Duplex*) - The cable distances for the fiber port are constrained by the cable requirements.

DOWN (*Half-Duplex*) - The cable distances for the fiber port are constrained by the 512-Bit Rule.

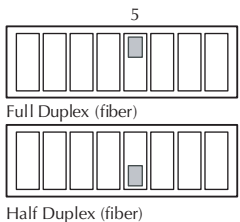

## Installation -- continued

#### 6. Link Pass-Through (*model 110 only*):

UP (*Enable*) - When Link Pass-Through is enabled, a fault on one side of the switch stops the signal and data transmission on the other side. See the detailed explanation of Link Pass-Through on page 18.

DOWN (*Disable*) - When Link Pass-Through is disabled, a fault on one side of the switch does not stop the signal and data transmission on the other side.

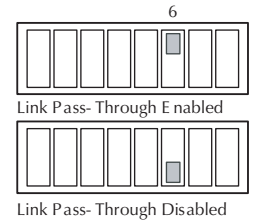

#### 7. Fiber redundancy (*model 130 only*):

UP (*Disable*) - When fiber redundancy is disabled, the two fiber ports (*1 and 2*) act as normal bridging ports.

DOWN (*Enable*) - When fiber redundancy is enabled, the two fiber ports (*1 and 2*) are configured as forwarding or disabled. At any given time one port will be disabled and one port will be forwarding.

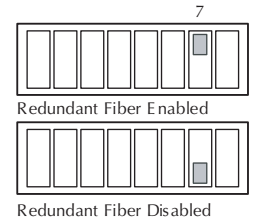

#### 8. AutoCross:

UP (*Enable*) - The switch will connect to a straight-through or a crossover twisted-pair copper cable automatically.

DOWN (*Disable*) - In the down position the straight-through or crossover twisted-pair copper cable must be installed according to the site requirements.

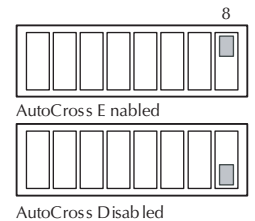

## Installation -- continued



**WARNING:** Make sure that the external power source is turned OFF before attempting to connect power leads to the industrial switch. Failure to observe this warning could result in an electrical shock.



**WARNING:** The SIBTF10xx-1xx-Mx is a class I device. It has a provision for protective earth grounding. Equipment grounding is vital to ensure safe operation. The SIBTF switch must be earth grounded during and after installation. Failure to observe this warning could result in an electric shock.

**Note:** DO NOT use bare (*exposed*) or un-lugged power-source wires to connect to the industrial switch.

### Connecting primary power

The industrial switch is designed to accommodate 48 – 170VDC or 90 – 125VAC, 50/60 Hz input power via its primary terminal block (TB).

To provide power to the industrial switch via the primary TB, view Figure 5, and then do the following:

1. Verify that the external power source is turned OFF and disconnect.
2. Loosen the grounding screw and then connect the power source functional-ground lead to the ground screw, as shown in Figure 5. Tighten the screw to secure.
3. Loosen the TB screw marked “-” and then connect the power source neutral or (-) negative lead to the TB negative terminal, as shown in Figure 5. Tighten the screw to secure.
4. Loosen the TB screw marked “+” and then connect the power source line phase or positive (+) lead to the TB positive terminal, as shown in Figure 5. Tighten the screw to secure.
5. Re-connect and turn ON the external power source.
6. Verify that the industrial switch has powered up by observing the illuminated “Power Good” LED on the front panel.

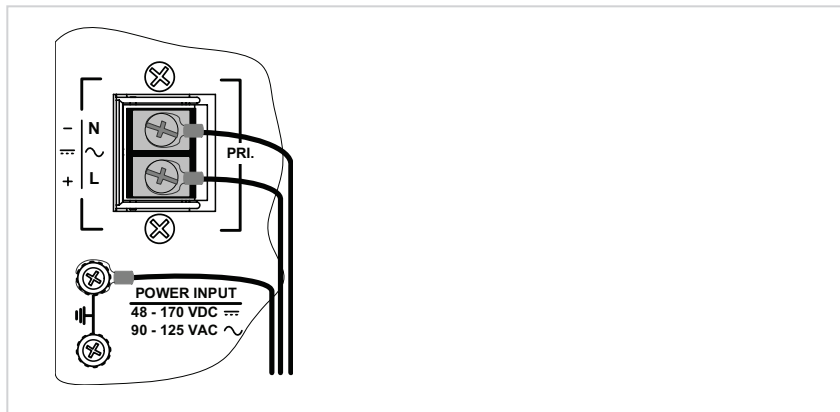

Figure 5: Primary Power Connection

## Installation -- continued



**WARNING:** Make sure that the external power source is turned OFF before attempting to connect power leads to the industrial switch. Failure to observe this warning could result in an electrical shock.



**WARNING:** The SIBTF10xx-1xx-Mx is a class I device. It has a provision for protective earth grounding. Equipment grounding is vital to ensure safe operation. The SIBTF switch must be earth grounded during and after installation. Failure to observe this warning could result in an electric shock.

**Note:** DO NOT use bare (*exposed*) or un-lugged power-source wires to connect to the SIBTF10xx-10x-MR industrial switch.

### Connecting auxiliary power

The SIBTF10xx-10x-MR switches support a redundant power supply. If the primary power source fails, the auxiliary power source supplies power to the industrial switch.

To provide auxiliary power to the industrial switch, view Figure 6 and do the following:

1. Verify that the external power source is turned OFF and disconnected.
2. Loosen the grounding screw and connect the power source functional-ground lead to the ground screw, as shown in Figure 6. Tighten the screw to secure.
3. Loosen the TB screw marked “-” and then connect the power source neutral or (-) negative lead to the TB negative terminal, as shown in Figure 6. Tighten the screw to secure.
4. Loosen the TB screw marked “+” and then connect the power source line phase or positive (+) lead to the TB positive terminal, as shown in Figure 6. Tighten the screw to secure.
5. Re-connect and turn ON the external power source.
6. Verify that the industrial switch is powered UP: auxiliary “Power Good” LED on the lower front panel will be ON.

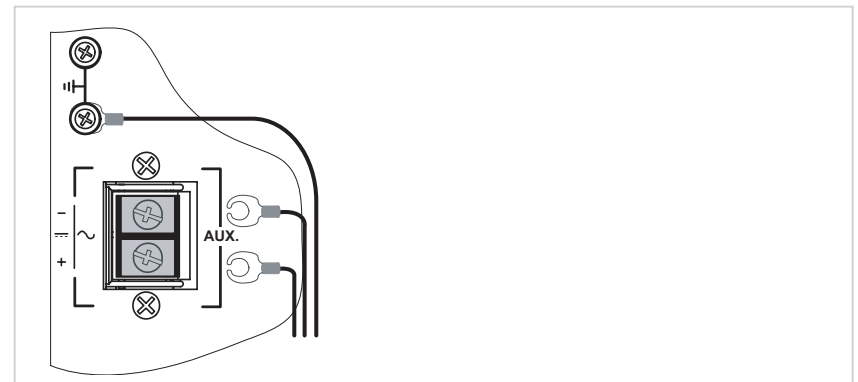

Figure 6: Auxiliary Power Connection

## Installation -- continued

### Internal relay connections

The internal relay can activate an external fault indicator. The fault indicator connects to the relay contacts on the front panel. An example would be a fault circuit connected to a warning light located in a control room. The light can be connected in a normally open (NO) or normally closed (NC) configuration with respect to circuit common (C) to turn the light ON/OFF when a fault occurs.

To connect a fault indicator to the relay, view Figure 7 and then do the following:

1. Verify that the external power source is turned OFF.
2. Loosen the relay's "NO" screw and then connect the fault indicator's return lead to terminal "NO." Tighten the screw to secure.
3. Loosen the relay's "C" screw and then connect the fault indicator's common lead terminal "C." Tighten the screw to secure.

Or:

4. Loosen the relay's "NC" screw and then connect the fault indicator's return lead to terminal "NC." Tighten the screw to secure.
5. Loosen the relay's "C" screw and then connect the fault indicator's common lead terminal "C." Tighten the screw to secure.

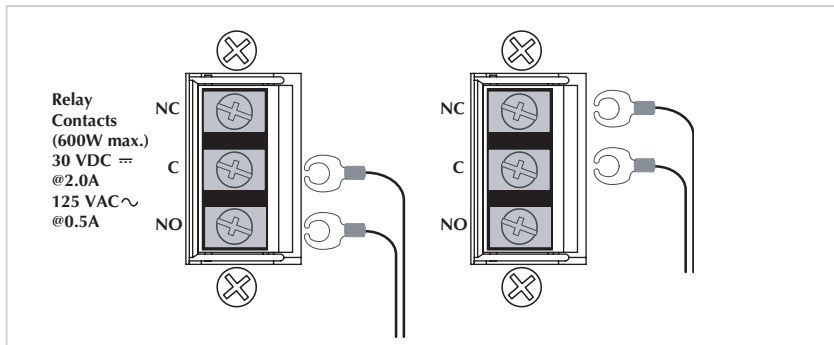

Figure 7: Internal Relay Connections

Two wiring scenarios:

- Wiring the relay in the normally closed (NC) configuration can be used to monitor alarm indicators connected in series, where any single event will cause all alarm indicators to trigger.
- Wiring the relay in the normally open (NO) configuration can be used to monitor alarm indicators connected in parallel, where any single event will cause that events alarm indicator to trigger: i.e., a light turning ON or OFF.



**CAUTION:** Calculate the maximum possible current in each power wire and relay-contact wire. Observe all electrical codes for maximum current allowed. If the current goes above the maximum ratings, the wiring could overheat and cause serious damage to the network wiring or equipment.

## Installation -- continued

### DIN-Rail

The industrial switch includes an aluminum DIN-Rail mounting bracket attached to the back panel of the enclosure. See Figure 8.

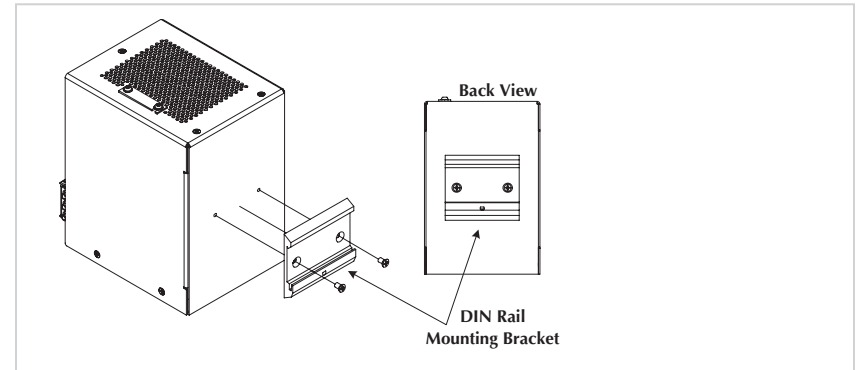

Figure 8: DIN-Rail Bracket

### Mounting the enclosure to a DIN-Rail



**CAUTION:** The SIBTF10xx-1xx switch is convection cooled, requiring unrestricted bottom-to-top airflow. Mounting the device in other orientations could result in unreliable operation or device failure.



**CAUTION:** To prevent debris from falling through the ventilation holes, local and national electrical and fire codes might require orienting the device with its small-diameter vent holes downward.

To mount the enclosure onto a DIN-Rail:

1. Insert the top of the DIN-Rail into the upper slot of the mounting plate.
2. Push down and then rotate the industrial switch inward to snap it into place onto the DIN-Rail.

An illustration of the procedure is shown in Figure 9.

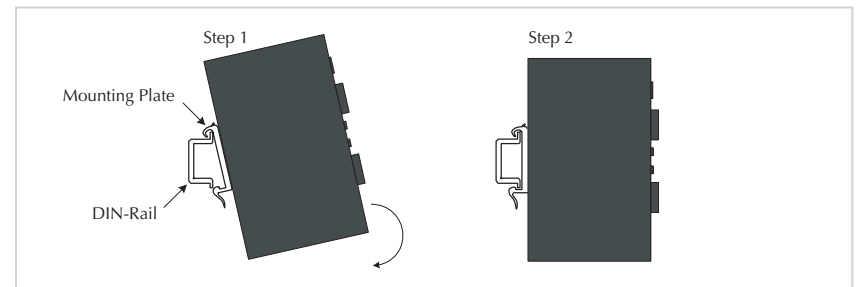

Figure 9: Enclosure Mounted to DIN-Rail

## Installation -- continued

### Installing fiber cable

To install a fiber cable, view Figure 10, and then do the following:

1. Locate or build 100Base-FX fiber cable with male, two-stranded TX to RX connectors installed at both ends.
2. Connect the fiber cables to the industrial switch as follows:
  - Connect the male TX cable connector to the female TX port.
  - Connect the male RX cable connector to the female RX port.
3. Connect the fiber cables to the other device (*another media converter, hub, etc.*) as follows:
  - Connect the male TX cable connector to the female RX port.
  - Connect the male RX cable connector to the female TX port.

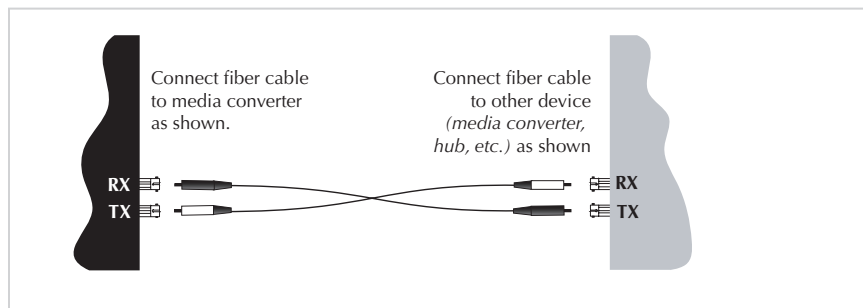

Figure 10: Fiber Cable Installation

### Installing copper cable

The AutoCross feature allows connecting straight-through (MDI) or crossover (MDI-X) copper cable to the RJ-45 port of a second device.

To install an Ethernet cable, view Figure 11, and then do the following:

1. Locate or build 10Base-T or 100Base-TX copper cables with male, RJ-45 connectors installed on both ends.
2. Connect the RJ-45 connector at one end of the cable to the RJ-45 port on the industrial switch.
3. Connect the RJ-45 connector at the other end of the cable to the RJ-45 port on the second device (*PLC, workstation, etc.*).

## Installation -- continued

### Installing copper cable

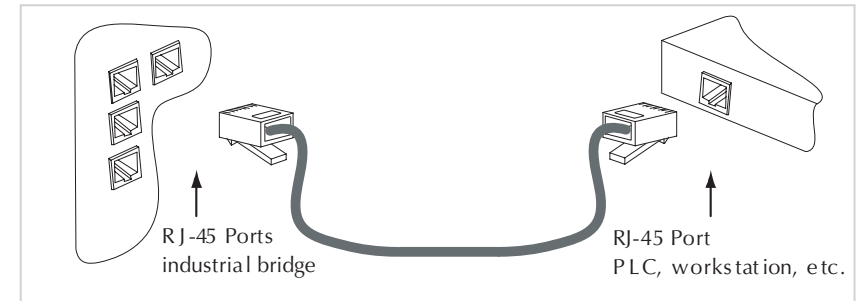

Figure 11: Copper Cable Installation

## Operation

### Copper/fiber status LEDs

#### Copper LEDs

The SIBTF10xx-1xx-Mx comes equipped with status LEDs to monitor the network connections for the copper and fiber ports.

The numbered LEDs refer to the numbered copper and fiber ports. For example, LED #1 refers to the twisted-pair copper port #1; LED #2 refers to fiber port #2. See Figure 12.

Each port has three associated LEDs: Full duplex (FD), 10MB, and 100MB.

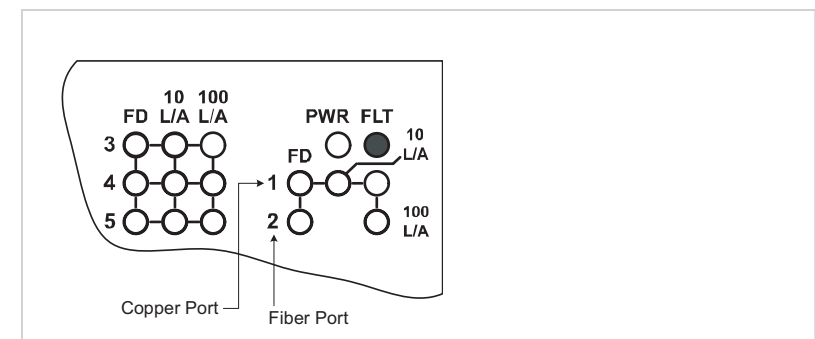

Figure 12: Copper and Fiber Port Status LEDs



## Operation -- continued

### Copper/fiber status LEDs -- continued

#### Copper LEDs

The function of the copper port LEDs (1, 2, 3, and 4) are as follows:

100MB	ON	The copper port has established a link at 100 MB/s.
100MB	Flashing	The copper port is transmitting signals at 100 Mb/s.
10MB	ON	The copper port has established a link at 10 MB/s.
10MB	Flashing	The copper port is transmitting signals at 10 Mb/s.
FD	ON	The copper port is in full-duplex mode.
FD	OFF	The copper port is in half-duplex mode.

#### Fiber LEDs

The functions of the fiber port LEDs (2 and 5) are as follows:

100MB	ON	The fiber port has established a link.
100MB	Flashing	The fiber port is transmitting signals.
10MB	--	N/A
10MB	--	N/A.
FD	ON	The fiber port is in full-duplex mode.
FD	OFF	The fiber port is in half-duplex mode.

#### Fault (red) LED

Fault LED ON (red) indicates that the microcontroller did not initialize correctly; as a result, the switch will not power up.

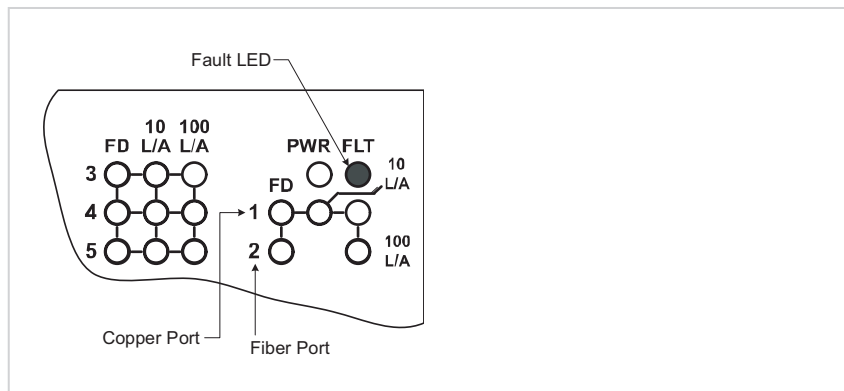

Figure 13: Fault LED

## Operation -- continued

### Product Features

#### Immunity standards

The industrial switch is designed to meet EN61000-6-2, IEEE1613.

#### Congestion reduction

The SIBTF10xx-1xx industrial switch does not forward collision signals or error packets from one collision domain to another, which improves baseline-network performance. In addition, the industrial switch filters packets destined for local devices, which reduces network congestion.

#### Rate conversion

The SIBTF10xx-1xx industrial switch allows connecting 10Mb/s terminal devices on a 10Base-T legacy Ethernet copper network and/or 100Mb/s terminal devices on a 100Base-TX fast Ethernet copper network to 100Mb/s terminal devices on a 100Base-FX fast Ethernet fiber network.

#### Full-Duplex network

In a full-duplex network, maximum cable lengths are determined by the type of cables used. See cable specifications section for the different SIBTF10xx-1xx models. The 512-Bit Rule does not apply in a full-duplex network.

#### Half-Duplex network (512-Bit Rule)

In a half-duplex network, the maximum cable lengths are determined by the round trip delay limitations of each fast Ethernet collision domain. (A collision domain is the longest path between any two terminal devices: e.g., a terminal, switch, or router.)

The 512-Bit Rule determines the maximum length of cable permitted by calculating the round-trip delay in bit-times (BT) of a particular collision domain. If the result is less than or equal to 512 BT, the path is good.

For more information on the 512-Bit Rule, see the white paper titled "Collision Domains" on the Transition Networks website at: [www.transition.com](http://www.transition.com).

## Operation -- continued

### Product features -- continued

#### Auto-Negotiation

The Auto-Negotiation feature allows the SIBTF10xx-1xx industrial switch to configure itself to achieve the best possible mode of operation over a link automatically. The industrial switch broadcasts its speed (*10 Mb/s or 100 Mb/s*) and duplex capabilities (*full or half*) to the other devices and negotiates the best mode of operation. Auto-Negotiation allows quick and easy installation because the optimal link is established automatically.

In a scenario where the industrial switch is linked to a non-negotiating device, the admin person may want to disable Auto-Negotiation. In this instance, the mode of operation will drop to the lowest common denominator between the two devices: 10 Mb/s, half-duplex. Disabling this feature provides the ability to force the connection to the best mode of operation.

#### Link Pass-Through

The SIBTF10xx-110 industrial switch provides a Link Pass-Through feature, which allows monitoring its fiber (FX) and copper (RX) ports for signal loss. Refer to Figure 14, in the event of an RX signal loss (1), the industrial switch will automatically disable the TX (*transmit*) signal (2) thus “passing through” the link loss (3). The far-end device is automatically notified of the link loss (4), which prevents data losses by transmitting data over an invalid link unknowingly.

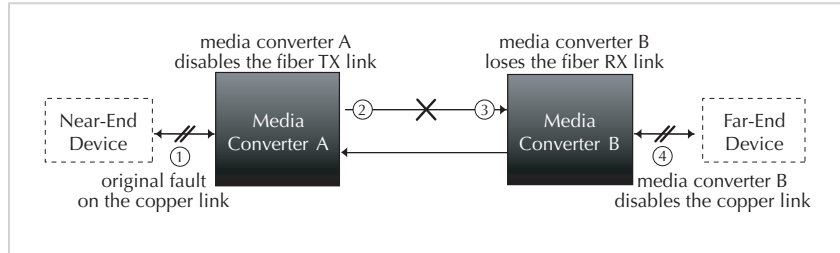

Figure 14: Link Pass-Through

#### Fiber Redundancy

The SIBTF10xx-130 industrial switch provides stable, fiber redundancy in highly critical Ethernet and Fast Ethernet segments.

When the fiber redundancy feature is enabled, only one fiber connection (*primary*) is active at a time. This primary connection is in the forwarding stage while the other fiber connection (*secondary*) is put in the standby state.

When failure on the primary fiber connection occurs, it is detected by the switch. The secondary connection is activated and becomes the primary link. The original fiber link is disabled until the failure on the primary fiber connection is corrected. Once corrected, the original order is restored.

**Note:** The fiber redundancy feature is for point-to-point applications, and not for redundant ring applications.

## Operation -- continued

#### AutoCross™

When the AutoCross feature is activated, it allows the use of straight-through MDI or crossover MDI-X cables for connecting to 10Base-T or 100Base-TX devices.

AutoCross determines the characteristics of the connection and automatically configures the unit to link up, regardless of the cable configuration, either MDI or MDI-X.

#### Replacing the fuse

**Note:** The fuse may be “hot swapped” (*i.e., replaced while the industrial switch is in operation*) provided the power source associated with the burned-out fuse has been disconnected. For example, the primary fuse may be replaced provided that power to the primary power contacts has been turned OFF.

To replace the fuse, view Figure 15, and then do the following:

1. Turn OFF and disconnect the power source associated with the blown fuse.
2. Using a flat-head screwdriver, unscrew (*counter-clockwise*) and remove the fuse holder. See Figure 15.
3. Carefully remove the fuse from the fuse holder.
4. Install a same size and rated (*2.5 A, 250 V*) replacement fuse in the fuse holder.
5. Insert the fuse holder with the fuse into the switch and rotate clockwise to secure.
6. Re-connect and turn ON the power source.
7. Verify that the industrial switch is powered UP: “Power Good” LED on the upper front panel will be ON.

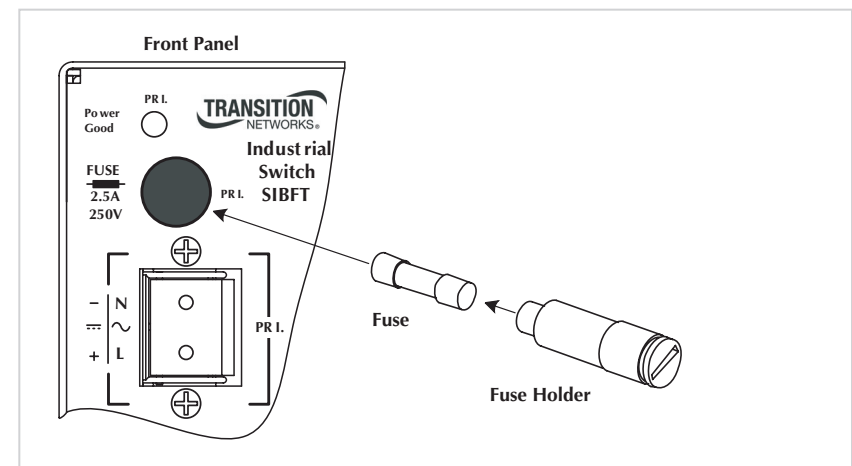

Figure 15: Fuse Replacement

## Cable Specifications

The physical characteristics must meet or exceed IEEE 802.3™ specifications.

### Copper Cable

Category 3: (*Minimum requirement for 10 Mb/s operation*)

Gauge 24 to 22 AWG  
Attenuation 11.5 dB/100m @ 5-10 MHz  
Maximum Cable Distance 100 meters

Category 5: (*Minimum requirement for 100 Mb/s operation*)

Gauge 24 to 22 AWG  
Attenuation 22.0 dB/100m @ 100 MHz  
Maximum Cable Distance 100 meters

- Straight-through or crossover twisted-pair cable may be used.
- Shielded (STP) or unshielded (UTP) twisted-pair cable may be used.
- Pins 1&2 and 3&6 are the two active pairs in an Ethernet network .
- Use only dedicated wire pairs for the active pins:  
(e.g., blue/white & white/blue, orange/white & white/orange, etc.)

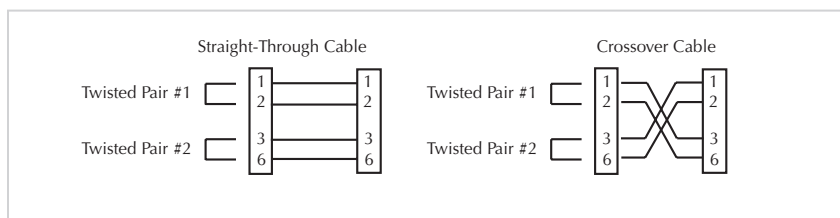

Figure 16: Copper Cable Configurations

- Do not use flat or silver satin wire.



**WARNING:** Visible and invisible laser radiation when open. Do not stare into the beam or view the beam directly or with optical instruments. Failure to observe this warning could result in an eye injury or blindness.



**WARNING:** Use of controls, adjustments, or the performance of procedures other than those specified herein may result in hazardous radiation exposure.

### Fiber cable

Bit Error Rate: <math><10^{-9}</math>  
single mode fiber (*recommended*): 9  $\mu\text{m}$   
Multimode fiber (*recommended*): 62.5/125  $\mu\text{m}$   
Multimode fiber (*optional*): 100/140, 85/140, 50/125  $\mu\text{m}$   
SIBTF1011-1xx-Mx 1300 nm multimode  
Fiber Optic Transmitter Power: min: -19.0 dBm max: -14.0 dBm  
Fiber Optic Receiver Sensitivity: min: -30.0 dBm max: -14.0 dBm  
Link Budget: 11.0 dB

## Cable Specifications -- continued

SIBTF1013-1xx-Mx 1300 nm multimode  
Fiber Optic Transmitter Power: min: -19.0 dBm max: -14.0 dBm  
Fiber Optic Receiver Sensitivity: min: -30.0 dBm max: -14.0 dBm  
Link Budget: 11.0 dB

SIBTF1014-1xx-Mx 1310 nm single mode  
Fiber-optic Transmitter Power: min: -15.0 dBm max: -8.0 dBm  
Fiber-optic Receiver Sensitivity: min: -31.0 dBm max: -8.0 dBm  
Link Budget: 16.0 dB

SIBTF1015-1xx-Mx 1310 nm single mode  
Fiber-optic Transmitter Power: min: -8.0 dBm max: -2.0 dBm  
Fiber-optic Receiver Sensitivity: min: -34.0 dBm max: -7.0 dBm  
Link Budget: 26.0 dB

SIBTF1016-1xx-Mx 1310 nm single mode  
Fiber-optic Transmitter Power: min: -5.0 dBm max: 0.0 dBm  
Fiber-optic Receiver Sensitivity: min: -34.0 dBm max: -7.0 dBm  
Link Budget: 29.0 dB

SIBTF1017-1xx-Mx 1550 nm single mode  
Fiber-optic Transmitter Power: min: -5.0 dBm max: 0.0 dBm  
Fiber-optic Receiver Sensitivity: min: -34.0 dBm max: -7.0 dBm  
Link Budget: 29.0 dB

This device is certified by the manufacturer to comply with DHHS Rule 21/CFR, Subchapter J applicable at the date of manufacture.

**CAUTION:** Visible and invisible laser radiation when open. Do not stare into beam or view directly with optical instruments.

**CAUTION:** Use of controls, adjustments or the performance of procedures other than those specified herein may result in hazardous radiation exposure.

The fiber optic transmitters on this device meet Class I Laser safety requirements per IEC-825/CDRH standards and comply with 21 CFR1040.10 and 21CFR1040.11.

## Technical Specifications

For use with Transition Networks Model SIBTF10xx-1xx-Mx or equivalent.

Standards:	IEEE 802.3™ 2000, IEEE 802.3x™
Data Rate:	10 Mb/s, 100 Mb/s ( <i>copper</i> ), 100 Mb/s ( <i>fiber</i> )
Dimensions:	Models 130- & 140-Mx ( <i>W x H x D</i> ) 4.125" x 6" x 5" (104.77 x 152.4 x 127 mm)
Dimensions:	Model 110-Mx ( <i>W x H x D</i> ) 3.375" x 6" x 5" (85.73x 152.4 x 127 mm)
Weight:	3.2 lb. (1.5 kg) approximately
Input Voltage:	48–170VDC +/-15% 90–125VAC +/-15%, 50/60 Hz
Power:	15 W ( <i>maximum</i> ) Aux input standby power, 200 mW typically
Fuse:	2.5 A/250 VDC
Alarm Relay:	Three-position screw terminal block for the dry contact relay 0.5 A @ 125 VAC / 2.0 A @ 30 VDC ( <i>maximum</i> ) switching capacity: 60 W ( <i>maximum</i> )
Packet Size:	Memory: 64K Bytes Unicast MAC addresses: 1000 Maximum packet size: 1536 Bytes
MTBF*:	51,115 MIL-HDBK-217F Hours 153,038 Bellcore Hours

### Environment

Operating Temp:	-40 to 75°C (-40 to 167°F)
Storage Temp:	-40 to 85°C (-40 to 185°F)
Humidity:	5 to 95%, non-condensing
Altitude:	3000 m (10,000 ft.)
Warranty:	Lifetime

The industrial switch is designed for installation in restricted access locations. Installing the industrial switch into other equipment or facility control rooms must comply with the fire-enclosure requirements of IEC60950/EN60950/UL60950, along with other local, national fire and safety codes.

**IMPORTANT:** Copper based media ports: e.g., Twisted Pair (TP) Ethernet, USB, RS232, RS422, RS485, DS1, DS3, Video Coax, etc. are intended for connecting to intra-building (*inside plant*) link segments, not subject to lightning transients or power faults. Copper based media ports: e.g., Twisted Pair (TP) Ethernet, USB, RS232, RS422, RS485, DS1, DS3, Video Coax, etc. are NOT for connecting to inter-building (*outside plant*) link segments subject to lightning transients or power faults.

\*MTBF is estimated using the predictability method. This method is based on MIL-217F at 25°C ambient temperature, typical enclosure heat rise of 10°C, and nominal operating conditions and parameters. Installation and configuration specific MTBF estimates are available upon request. Contact Technical Support.

## Technical Specification -- continued

### 220–240VAC, 50/60Hz installation

**CAUTION:** If the main power source is 220-240VAC @50/60Hz, use a 2:1, 50VA or greater step-down transformer between the main power source and the industrial switch. Failure to observe this caution could result in a damaged switch.

### EMC Type Tests (*all test were performed using unshielded cables*)

Standard	Description	Compliance Level	Remarks
EN55022/FCC Part15	ITE Emissions	Class A	Conducted and radiated
EN55024/EN61000-6-2:	ITE Emissions		
IEC61000-4-2		Level 2	ESD contact discharge
IEC61000-4-3		Level 4	Radiated fields
IEC61000-4-4		Level 3	Fast transients - power port 2 meter cable AC 1 meter cable DC
		Level 2	Fast transient – Ethernet port 3 meter cable length
IEC6100-4-5		Level 3 CM Level 2 DM Level 1 DC	Surge – power port 2 meter cable AC 1 meter cable DC
		Level 2	Surge – relay port 1 meter cable length
		Level 2	Surge – Ethernet port 3 meter cable length
IEC61000-4-5		EN61000-6-2 Level 3 EN55024 Level 2	Conducted – power port 2 meter cable AC, 1 meter cable DC
		EN61000-6-2 Level 3 EN55024 Level 2	Conducted – relay port 1 meter cable length
		EN61000-6-2 Level 3 EN55024 Level 2	Conducted – PE Studs 2 meter cable length
		EN61000-6-2 Level 3 EN55024 Level 2	Conducted – Ethernet port 10 meter cable length
IEC61000-4-8		Level 1	Power freq. mag. field
IEC61000-4-11		N/A	VoltageDIPs and variations

### IEEE1613, Power Substation Testing

IEEE1613, Clause 6.2		Not rated	Dielectric power freq.
IEEE1613, Clause 6.3		Compliant	Impulse voltage all ports
IEEE1613, Clause 7.3.1		Class 2 transverse and common Mode	Surge oscillatory waveform –power AC
		Class 2 transverse and common Mode	Surge oscillatory waveform –power DC
		Class 2 common mode	Surge oscillatory waveform –relay port
		Class 2 common mode	Surge oscillatory waveform –Ethernet 10 Mbps
		Class 1 common mode	Surge oscillatory waveform – Ethernet 100 Mbps

## Technical Specification -- continued

### EMC Type Tests -- Continued

Standard	Description	Compliance Level	Remarks
<i>IEEE1613, Power Substation Testing -- Continued</i>			
IEEE1613, Clause 7.3.2		Class 2 transverse mode Class 1 common mode	Surge fast transient waveform – power AC
		Class 2 transverse mode Class 1 common mode	Surge fast transient waveform – power DC
		Class 1 common mode	Surge fast transient waveform – relay port
		Class 1 common mode	Surge fast transient waveform – Ethernet 10 Mbps
		Class 1 common mode	Surge fast transient waveform – Ethernet 100 Mbps
IEEE1613, Clause 8		Class 2	Radio frequency susceptibility
IEEE1613, Clause 9		Class 1	ESD contact discharge 8kV

## Troubleshooting

If the industrial switch fails, isolate and correct the failure by determining the answers to the following questions and then taking the indicated action:

- Is the “PRI” (*primary power*) LED illuminated?  
NO
  - Ensure the power source is the proper voltage (*48–170 VDC or 90–125 VAC, 50/60Hz*).
  - Ensure that the positive, negative, and ground wires from the power source are properly connected to the primary inputs.
  - Contact Technical Support: US/Canada: 1-800-260-1312, International: 00-1-952-941-7600.
 YES
  - Proceed to step 2.
- (*SIBTF10xx10x-MR models only*) is the “AUX” (*auxiliary power*) LED illuminated?  
NO
  - If the device does not have an auxiliary power source, proceed to step 3.
  - Ensure the power source is the proper voltage (*48–170 VDC or 90–125 VAC, 50/60Hz*).
  - Ensure that the positive, negative, and ground wires from the power source are properly connected to the auxiliary inputs.
  - Contact Technical Support: US/Canada: 1-800-260-1312, International: 00-1-952-941-7600.
 YES
  - Proceed to step 3.

## Troubleshooting -- continued

- Is the “FAULT” LED illuminated?  
NO
  - Proceed to step 4.
 YES
  - Contact Technical Support: US/Canada: 1-800-260-1312, International: 00-1-952-941-7600.
- For each port with a cable installed is either the “10MB” or the “100MB” LED illuminated?  
YES
  - Proceed to step 5.
 NO
  - For each port with a cable installed and its LED is OFF, check the cable for proper connection.
  - For the fiber ports, verify that the TX and RX cables on the SIBTF10xx-10x are connected to the RX and TX ports, respectively, on the device at the other end of the fiber cables.
  - Contact Technical Support: US/Canada: 1-800-260-1312, International: 00-1-952-941-7600
- For each RJ-45 port with a cable installed (*ports 1, 2, 3, and 4*), check to see if the 10MB or 100MB LED is illuminated.
  - 10MB is ON = The industrial switch has selected 10Mb/s operation.
  - 100MB is ON = The industrial switch has selected 100Mb/s operation.
  - If the speed is not correct, disconnect and reconnect the cable to restart the initialization process.
  - Proceed to step 6.
- For each fiber port with a cable installed, is the “FD” (*full-duplex*) LED illuminated?  
NO
  - The industrial switch has selected half-duplex mode.
  - If the mode is not correct, disconnect and reconnect cable to restart the initialization process.
  - Check the cable for proper connection.
  - Contact Tech Support: 1-800-260-1312, Int'l: 00-1-952-941-7600.
 YES
  - The industrial switch has selected full-duplex mode.
  - If the mode is not correct, disconnect and reconnect cable to restart the initialization process.
  - Check the cable for proper connection.
  - Contact Tech Support: 1-800-260-1312, Int'l: 00-1-952-941-7600.

## Contact Us

### Technical support

Technical support is available 24 hours a day.

US and Canada: 1-800-260-1312

International: 00-1-952-941-7600

### Transition now

Chat live via the Web with Transition Networks Technical Support.

Log onto [www.transition.com](http://www.transition.com) and click the Transition Now link.

### Web-Based seminars

Transition Networks provides seminars via live web-based training.

Log onto [www.transition.com](http://www.transition.com) and click the Learning Center link.

### E-Mail

Ask a question anytime by sending an e-mail to our technical support staff.

[techsupport@transition.com](mailto:techsupport@transition.com)

### Address

Transition Networks



6475 City West Parkway

Minneapolis, MN 55344, U.S.A.

telephone: 952-941-7600

toll free: 800-526-9267

fax: 952-941-2322

 <b>Declaration of Conformity</b>	
Name of Mfg:	<b>Transition Networks</b> 6475 City West Pkwy, Minneapolis MN 55344 U.S.A.
Model:	SIBTF10xx-1xx Industrial switches
Part Number(s):	SIBTF1011-1xx-MR, SIBTF1013-1xx-MR, SIBTF1014-1xx-MR, SIBTF1015-1xx-MR, SIBTF1016-1xx-MR, SIBTF1017-1xx-MR,  SIBTF1011-1xx-MS, SIBTF1013-1xx-MS, SIBTF1014-1xx-MS, SIBTF1015-1xx-MS, SIBTF1016-1xx-MS, SIBTF1017-1xx-MS,
Regulation:	EMC Directive 89/336/EEC
Purpose:	To declare that the SIBTF10xx-1xx-Mx to which this declaration refers is in conformity with the following standards:
	CISPR 22:1993; EN 55022:1994+A1:1995+A2:1997 Class A; EN 55024:1998; EN 61000-6-2:2001; EN61000-4-2:1995; -4-3:2002; -4-4:1995; -4-5:1995; -4-6:1995
	I, the undersigned, hereby declare that the equipment specified above conforms to the above Directive(s) and Standard(s).
	<u>June 30, 2006</u>
Stephen Anderson, Vice-President of Engineering	Date

## Compliance Information

### EN55022, EN55024, EN61000-6-2:2001 & IEEE1613

**FCC Regulations** This equipment has been tested and found to comply with the limits for a Class A digital device, pursuant to part 15 of the FCC rules. These limits are designed to provide reasonable protection against harmful interference when the equipment is operated in a commercial environment. This equipment generates, uses, and can radiate radio frequency energy and, if not installed and used in accordance with the instruction manual, may cause harmful interference to radio communications. Operation of this equipment in a residential area is likely to cause harmful interference, in which case the user will be required to correct the interference at the user's own expense.

**Canadian Regulations** This digital apparatus does not exceed the Class A limits for radio noise for digital apparatus set out on the radio interference regulations of the Canadian Department of Communications.

Le présent appareil numérique n'émet pas de bruits radioélectriques dépassant les limites applicables aux appareils numériques de la Class A prescrites dans le Règlement sur le brouillage radioélectrique édicté par le ministère des Communications du Canada.

### European Regulations

**Warning:** This is a Class A product. In a domestic environment this product may cause radio interference in which case the user may be required to take adequate measures.

**Achtung !** Dieses ist ein Gerät der Funkstörgrenzwertklasse A. In Wohnbereichen können bei Betrieb dieses Gerätes Rundfunkstörungen auftreten. In diesem Fall ist der Benutzer für Gegenmaßnahmen verantwortlich.

**Attention !** Ceci est un produit de Classe A. Dans un environnement domestique, ce produit risque de créer des interférences radioélectriques, il appartiendra alors à l'utilisateur de prendre les mesures spécifiques appropriées.



**CAUTION: RJ connectors are NOT INTENDED FOR CONNECTION TO THE PUBLIC TELEPHONE NETWORK. Failure to observe this caution could result in damage to the public telephone network. Der Anschluss dieses Gerätes an ein öffentliches Telekommunikationsnetz in den EG-Mitgliedstaaten verstösst gegen die jeweiligen einzelstaatlichen Gesetze zur Anwendung der Richtlinie 91/263/EWG zur Angleichung der Rechtsvorschriften der Mitgliedstaaten über Telekommunikationsendrichtungen einschliesslich der gegenseitigen Anerkennung ihrer Konformität.**



In accordance with European Union Directive 2002/96/EC of the European Parliament and of the Council of 27 January 2003, Transition Networks will accept post usage returns of this product for proper disposal. The contact information for this activity can be found in the 'Contact Us' portion of this document.

**Trademark Notice**

All trademarks and registered trademarks are the property of their respective owners.

**Copyright Restrictions** © 2005 Transition Networks. All rights reserved. No part of this work may be reproduced or used in any form or means (*graphic, electronic, mechanical*) without written permission from Transition Networks.

## Free Manuals Download Website

<http://myh66.com>

<http://usermanuals.us>

<http://www.somanuals.com>

<http://www.4manuals.cc>

<http://www.manual-lib.com>

<http://www.404manual.com>

<http://www.luxmanual.com>

<http://aubethermostatmanual.com>

Golf course search by state

<http://golfingnear.com>

Email search by domain

<http://emailbydomain.com>

Auto manuals search

<http://auto.somanuals.com>

TV manuals search

<http://tv.somanuals.com>