

CONTENTS

- 02 INTRODUCTION AND PARTS LIST
- 03 GENERAL INFORMATION AND SAFETY INSTRUCTIONS
- 07 GETTING TO KNOW YOUR CAMERA
- 11 GETTING STARTED
- 13 CAPTURE MODE
- 15 VIDEO MODE
- 16 PLAYBACK MODE
- 19 MENU OPTIONS
- 24 TRANSFERRING FILES TO YOUR COMPUTER
- 25 USING THE CAMERA AS A PC CAMERA
- 26 EDITING SOFTWARE INSTALLATION
- 27 SPECIFICATIONS
- 28 APPENDIX
- 30 WARRANTY CARD

INTRODUCTION AND PARTS LIST

Congratulations on choosing to buy a Traveler product. All products brought to you by Traveler are manufactured to the highest standards of performance and safety, and, as part of our philosophy of customer service and satisfaction, are backed by our comprehensive 3 Year Warranty. Please fill in and return the Warranty Card to the address provided. We hope you will enjoy using your purchase for many years to come.

Parts list

Carefully unpack your camera and ensure that you have the following items:

- 1 x Digital Camera
- 1 x User's manual
- 1 x Software CD-ROM
- 1 x USB cable
- 1 x Camera strap
- 1 x Traveler Camera pouch
- 2 x AA size batteries
- 1 x Traveler 2GB SD memory card

GENERAL INFORMATION AND SAFETY INSTRUCTIONS



Trademark Information

- Microsoft® and Windows® are U.S. registered trademarks of Microsoft Corporation.
- Pentium® is a registered trademark of Intel Corporation.
- Macintosh is a trademark of Apple Inc.
- SD™ is a trademark.
- SDHC™ is a trademark.
- Other names and products may be trademarks or registered trademarks of their respective owners.

Product Information

- Product design and specifications are subject to change without notice. This includes primary product specifications, software, software drivers, and user's manual. This User Manual is a general reference guide for the product.
- The product and accessories that come with your camera may be different from those described in this manual. This is due to the fact that different retailers often specify slightly different product inclusions and accessories to suit their market requirements, customer demographics, and geographical preferences. Products very often vary between retailers especially with accessories such as batteries, chargers, AC adapters, memory cards, cables, pouches, and language support. Occasionally a retailer will specify a unique product color, appearance, and internal memory capacity. Contact your dealer for precise product definition and included accessories.
- The illustrations in this manual are for the purpose of explanation and may differ from the actual design of your camera.
- The manufacturer assumes no liability for any errors or discrepancies in this user manual.

GENERAL INFORMATION AND SAFETY INSTRUCTIONS

2

SAFETY INSTRUCTIONS

Read and understand all **Warnings** and **Cautions** before using this product.

Warnings

If foreign objects or water have entered the camera, turn the power off and remove the batteries.

Continued use in this state might cause fire or electric shock.



If the camera has fallen or its case has been damaged, turn the power off and remove the batteries.

Continued use in this state might cause fire or electric shock.



Do not disassemble, alter or repair the camera.

This might cause fire or electric shock.



Do not use the camera in areas near water.

This might cause fire or electric shock. Take special care during rain, snow, on the beach, or near the shore.



Do not place the camera on inclined or unstable surfaces.

This might cause the camera to fall or tilt over, causing damage.



Keep the batteries out of the reach of children.

Swallowing batteries might cause poisoning. If the batteries are accidentally swallowed, immediately consult a physician.



Do not use the camera while you are walking, driving or riding a motorcycle.

This might cause you to fall over or result in a traffic accident.



Please use batteries with complete external seals.

Do not use batteries from which the seals have been damaged or removed. This may cause leakage, explosion, or injury.



GENERAL INFORMATION AND SAFETY INSTRUCTIONS

Cautions

Insert the batteries paying careful attention to the polarity (+ or -) of the terminals.

Inserting the batteries with the polarity inverted might cause fire and injury, or damage to the surrounding areas due to the battery rupturing or leaking.



Do not fire the flash close to anyone's eyes.

This might cause damage to the person's eyesight.



Do not subject the LCD monitor to impact.

This might damage the glass on the screen or cause the internal fluid to leak. If the internal fluid enters your eyes or comes into contact with your body or clothes, rinse with fresh water. If the internal fluid has entered your eyes, consult a physician to receive treatment.



A camera is a precision instrument. Do not drop it, strike it or use excessive force when handling the camera.

This might cause damage to the camera.



Do not use the camera in humid, steamy, smoky, or dusty places.

This might cause fire or electric shock.



Do not remove the batteries immediately after long period of continuous use.

The batteries become hot during use. Touching a hot battery might cause burns.



Do not wrap the camera or place it in cloth or blankets.

This might cause heat to build up and deform the case, resulting in fire. Use the camera in a well-ventilated place.



Do not leave the camera in places where the temperature may rise significantly, such as inside a car.

This might adversely affect the case or the parts inside, resulting in fire.



Before you move the camera, disconnect cords and cables.

Failure to do this might damage cords and cables, resulting in fire and electric shock.



Notes on Battery Usage

When you use the batteries, carefully read and strictly observe the **Safety Instructions** and the notes described below:

- Use only the specified batteries.
- Avoid using the batteries in extremely cold environments as low temperatures can shorten the battery life and reduce digital camera performance.
- Fully charge and discharge battery for one complete cycle prior to first use. Using new rechargeable batteries, or batteries which have not been used for a long time, without first charging/discharging may cause the battery life to be shorter than optimum.
- The batteries may feel warm after a long period of continuous use of the camera or the flash. This is normal and not a malfunction.
- The camera may feel warm after long periods of continuous use. This is normal and not a malfunction.
- If the batteries are not to be used for a long period of time, store them after the battery power has been drained. If the batteries are stored for a long time in a fully charged state, their performance may be impaired.
- Always keep the battery terminals clean.
- There is a risk of explosion if the batteries are replaced by an incorrect type.
- Dispose of used batteries according to the recycle instructions.
- Charge the rechargeable batteries fully before the first use.
- Never use batteries of different types (together) or mix old and new batteries.
- Never use manganese batteries.
- To prevent short-circuiting or fire, keep the batteries away from other metal objects when carrying or storing.

Front View

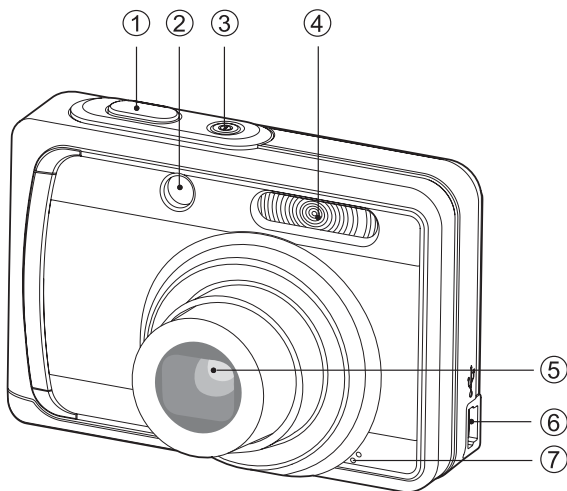

- 1. Shutter button
- 2. Self-timer LED
- 3. Power button
- 4. Flash
- 5. Lens
- 6. USB connector
- 7. Microphone

GETTING TO KNOW YOUR CAMERA

3

Rear View

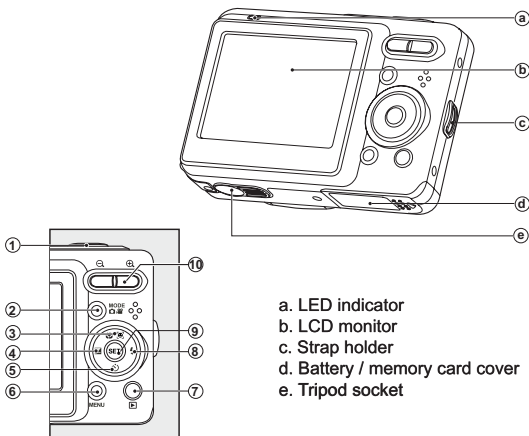

- a. LED indicator
- b. LCD monitor
- c. Strap holder
- d. Battery / memory card cover
- e. Tripod socket

Item	Function		
	Capture Mode	Video Mode	Playback Mode
1.	Shutter Button	Record Button	Previous mode
2.	Video mode	Capture mode	Previous mode
3.	Focus Auto > > > >	Focus Normal > >	Next 10th image
4.	Compensation >	--	Previous file
5.	Self-timer Off > 2s > 10s > 10+2s	Self-timer Off > 2s > 10s	Previous 10th image
6.	Menu	Menu	Menu
7.	Playback mode	Playback mode	Previous mode
8.	Flash Auto > > > >	--	Next file
9.	Set	Set	Set Voice memo Rec. ()
10.	Zoom *** Wide Tele	Zoom *** Wide Tele	Zoom Zoom out Zoom in

GETTING TO KNOW YOUR CAMERA

3

LCD Monitor Display

■ Capture mode

1. Scene mode

2. Flash mode

[Blank] Auto Flash

[] Flash On

[] Flash Off

[] Red-eye

[] Slow Sync

[] Pre-flash

3. Zoom status

4. Battery condition

[] 100% battery power

[] 75% battery power

[] 50% battery power

[] less than 20% battery power

[] less than 5% battery power

5. Storage media

[] Internal memory (no card)

[] SD/SDHC memory card

6. Quick Shot

7. Image size resolution

[] 5M (2560 x 1920 pixels)

[] 3M (2048 x 1536 pixels)

[] 1.2M (1280 x 960 pixels)

[] VGA (640 x 480 pixels)

8. Image quality

[] Fine

[] Standard

[] Economy

9. Available number of shots

10. Main focus area

11. Date

12. Self-timer icon

[] 2 sec.

[] 10 sec.

[] 10+2 sec.

13. ISO

14. [] Backlight correction

[] Exposure compensation

15. Slow shutter warning

■ Poor lighting conditions.

Images will be vulnerable to vibration.

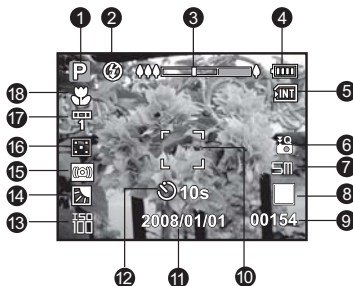

16. Metering

[] Center

[] Spot

[] Average

17. W.Balance

[Blank] Auto

[] Incand.

[] Fluoresc.1

[] Fluoresc.2

[] Daylight

[] Cloudy

[] Manual WB

18. Focus setting

[Blank] Auto focus

[] Face Detect

[] Macro

[] Infinity

■ Video mode []

1. Mode icon
2. Flash mode
3. Zoom status
4. Battery condition
5. Storage media
6. Audio off icon
7. Video resolution
8. Video quality
9. Available recording time/Elapsed time
10. Main focus area
11. Date
12. Self-timer icon
13. Focus setting

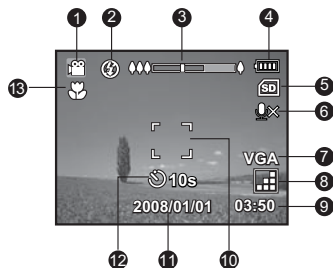

■ Playback mode [] - Still image playback

1. Voice memo
2. Battery condition
3. Storage media
4. Histogram
5. Image size resolution
6. Image quality
7. File number
8. Folder number
9. Date and time
10. Exposure value
11. Aperture value
12. Shutter speed value
13. DPOF icon
14. Protect icon
15. Mode icon

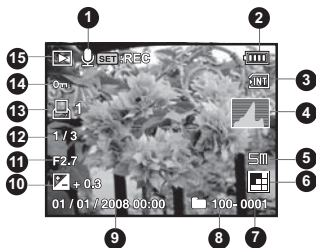

■ Playback mode [] - Video playback

1. Total recorded time
2. Video status bar
3. Elapsed time
4. File number
5. Folder number
6. Play mode
7. Mode icon
8. Protect icon

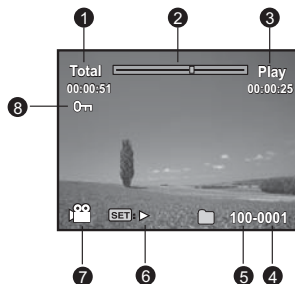

GETTING STARTED

4

Preparation

1. Attach the camera strap.

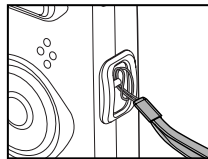

2. Open the battery/memory card cover.
3. Load the supplied batteries with correct orientation as shown.

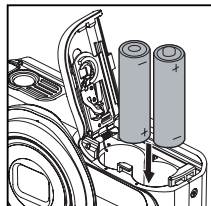

4. Insert an SD/SDHC memory card.
 - The camera has 32MB internal memory (28MB available for image storage), but you can load an SD/SDHC memory card to expand the camera's memory capacity.
 - Be sure to format the memory card with this camera before its initial usage.
5. Close the battery/memory card cover and make sure it is locked securely.

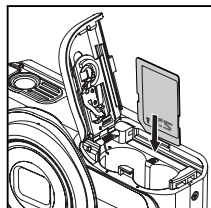

- To prevent valuable data from being accidentally erased from an SD/SDHC memory card, you can slide the write protect tab (on the side of the SD/SDHC memory card) to "LOCK".
- To save, edit, or erase data on an SD/SDHC memory card, you must unlock the card.
- To prevent damaging of an SD/SDHC memory card, be sure to turn off the power when inserting or removing the SD/SDHC memory card. If inserting or removing the SD/SDHC memory card with the power on, the camera will automatically turn off.
- Be careful not to drop the batteries when opening or closing the battery cover.

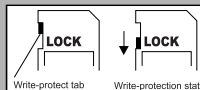

Initial Settings

The language & date/time needs to be set if and when:

- The camera is turned on for the first time.
- The camera is turned on after leaving the camera without the battery for an extended period of time.
 1. Press the **ON/OFF** button to turn the power on.
 2. Press any button to enter language setup. Select the displayed language with the ◀ / ▶ / ▲ / ▼ buttons and press the **SET** button.
 3. Select the date format with the ▲ / ▼ buttons, and press the **SET** button.
 4. Select the item's field with the ◀ / ▶ buttons and adjust the value for the date and time with the ▲ / ▼ buttons.
 5. After confirming all settings are correct, press the **SET** button.
 - Half press the shutter button or press the **MENU** button will enter capture mode without saving the settings.

Setting the Date and Time

When the date and time information is not displayed on the LCD monitor, follow these steps to set the correct date and time.

1. Toggle the MODE button to [📷] or [📷]; or press the  button.
2. Press the **MENU** button.
3. Select [Setup] with the ▶ button.
4. Select [Date/Time] with the ▲ / ▼ buttons, and press the **SET** button.
5. Select the date format with the ▲ / ▼ buttons, and press the **SET** button.
 - Select the item's field with the ◀ / ▶ buttons and adjust the value for the date and time with the ▲ / ▼ buttons.
 - After confirming all settings are correct, press press the **SET** button.
6. To exit from the [Setup] menu, press the **MENU** button.



Capturing Images

Your camera is equipped with a 2.36" LTPS-TFT LCD monitor to help you compose images, playback recorded images/video clips or adjust menu settings.

1. Press the Power button to turn the power on.
 - The status LED lights green and the camera is initiated.
2. Toggle the **MODE** button to [📷].
3. Compose your image in the LCD monitor.
 - Pressing the **+** button zooms in on the subject, and enlarges the subject on the LCD monitor.
 - Pressing the **⋄** button provides a wider angle image.
4. Press the shutter button.
 - Pressing the shutter button down halfway automatically focuses and adjusts the exposure, and pressing the shutter button down fully captures the images.
 - The focus area frame turns green when the camera is in focus and the exposure is calculated.
 - When the focus or exposure is not suitable, the frame of the focus area turns yellow.

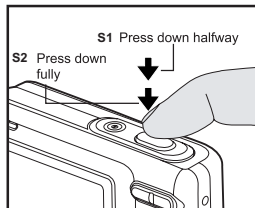

Capturing Images with Smile Detection Function

With the camera's new "smile detection" function, this camera captures automatically when a smiling face is detected. Ideal for joyful occasions, this ensures that a happy moment is never missed.

1. Press the **MENU** button, and select the [Capture] menu with the **◀ / ▶** button.
2. Select [Scene] with the **▲ / ▼** buttons, and press the **SET** button.
3. Select [Smile Shot] with the **▲ / ▼** buttons, and press the **SET** button. The camera returns to preview display.
4. Compose the image, and press the shutter button down fully.
5. Once the camera detects a smile, it will automatically capture 1 image (by default, the flash mode setting is set to **☺**).
 - When capturing group shots (the number of people is more than 1), the camera will automatically capture the image when it detects two greatest smile faces.
 - If the camera could not detect a smile within 5 seconds, the camera will automatically capture an image.
 - Press the shutter button once again to reactivate this function.

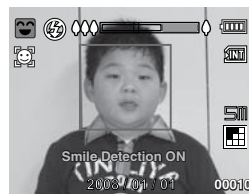

Capturing Images with Face Detection Technology

Face Detection Technology can identify and focus on human faces. This advanced function simultaneously detects up to 5 human faces regardless of their position in the scene.

1. Toggle the **MODE** button to **[📷]**.
2. Toggle the **[📷]** button until **[👤]** icon appears on the LCD monitor.
 - The white frame is identified as the “top priority” face (main focus frame), and gray ones around the other faces.
3. Press the shutter button halfway down to lock the focus.
 - The main focus frame simultaneously turns green.
 - If the “top priority” face is out of focus, the main focus frame turns red.
4. Press the shutter button down fully to capture your image.

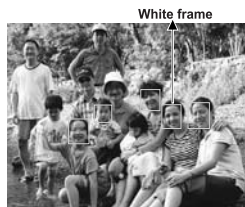

Face detection function is on



- Subjects that are not suitable with this function:
 - a. A person is wearing glasses, sunglasses, or face covered with hat or hair.
 - b. A person turned sideways.

Recording Video Clips

This mode allows you to record video clips at a resolution of 320 x 240 / 640 x 480 pixels. Voice can also be recorded.

1. Toggle the **MODE** button to [📹].
2. Compose the image.
3. Press the shutter button.
 - The recording of the video clip will start.
 - Pressing the shutter button one more time will end the recording of the video clip.
 - The recording time depends on the storage size and the subject of the image to be recorded.
 - The zoom function cannot be used during video recording.

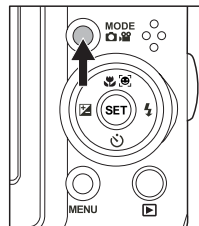

- When recording a video clip, the flash cannot be used.
- If the write speed of your SD/SDHC memory card is not fast enough for recording video clips in the currently selected size, and then the video recording will stop. In this case, select a video size lower than the current one.
- The maximum recordable time for one continuous video clip is 59:59.

Playing Back Still Images

This mode allows you to record video clips at a resolution of 320 x 240 / 640 x 480 pixels. You can play back the still images on the LCD monitor.

1. Press the [⏪] button.
 - The last image appears on the screen.
2. The images can be displayed in reverse or forward sequence with the ◀ / ▶ buttons.
 - To view the previous image, press the ◀ button.
 - To view the next image, press the ▶ button.
 - Pressing the ⏏ button enlarges the image.
 - To return to normal magnification, press the ⏏ button.

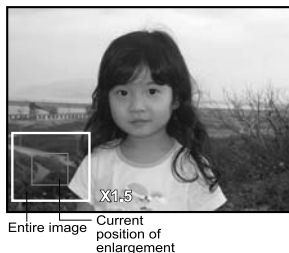

- An [📷] icon is displayed with the video data.

Playing Back Video Clips

You can play back recorded video clips on the camera.

1. Press the [⏪] button.
 - The last image appears on the screen.
2. Select the desired video clip with the ◀ / ▶ buttons.
3. Press the **SET** button.
 - A press of the ▶ / ◀ buttons during playback allows fast forward play / fast reverse play.
 - To stop video playback, press the ▼ button. This stops playback and returns to the start of the video clip.
 - To pause video playback, press the **SET** button. This pauses video playback. To cancel pause, press the **SET** button again.



- Video clips cannot be displayed rotated or enlarged.
- This camera does not have a built-in speaker so that you can not play back sound with the camera. To play the video clip back on your computer, you may use either Windows Media Player or Apple "QuickTime Player".
- QuickTime basic player is available free of charge, compatible with Mac and Windows-computers and can be downloaded from the Apple web site at www.apple.com. For help using QuickTime Player usage, please refer to the QuickTime on-line help for more information.

Playback Display

This function allows you to search quickly for the image that you want and playback images on the LCD monitor sequentially.

1. Press the [▶] button.
 - The last image appears on the screen.
2. Press the ▲ button to playback the next 10th image taken. Press the ▲ button again to playback the next 20th image taken and so forth.
3. Press the ▼ button to playback the previous 10th image taken. Press the ▼ button again to playback the previous 20th image taken and so forth.
4. Long press the ◀ / ▶ button to display the previous or next images automatically in sequential order.
 - Let go of the ◀ / ▶ button if you wish to stop the automatic playback.



- If the number of images is less than 10, the 1st image taken will be displayed when pressing the ▼ button; the last image taken will be displayed when pressing the ▲ button.
- Video clips will be displayed with an [📹] icon.

Removing Red-eye





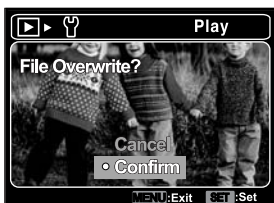



You can use this function to remove the red-eye effect after an image is taken.

1. Press the **[L]** button.
2. Select the image that you want to edit with the **◀ / ▶** buttons.
3. Press the **MENU** button.
4. Select [Fix Red Eyes] with the **▲ / ▼** buttons, and press the **SET** button.
5. Select [Execute] with the **▲ / ▼** buttons, and press the **SET** button.
6. View the changes on the corrected image.
7. To save your corrected image, select [Confirm] with the **▲ / ▼** buttons, and press the **SET** button.
 - The original image will be overwritten and replaced with the corrected image.



Capture Menu

This menu is for the basic settings to be used when capturing still images.

1. Toggle the  button to .
2. Press the **MENU** button, and select the [Capture] / [Function] menu with the  /  button.
3. Select the desired option item with the  /  buttons, and press the **SET** button to enter its respective menu.
4. Select the desired setting with the  /  buttons, and press the **SET** button.
5. To exit from the menu, press the **MENU** button.

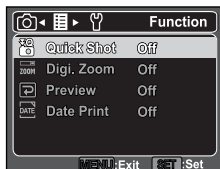
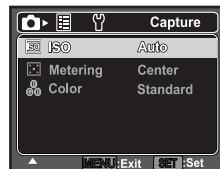





Scene

Select from 21 different scene modes in accordance with the shooting conditions.

- Program AE / Smile Shot / Anti-shake / Portrait Man / Portrait Lady / Landscape / Sports / Night Portrait / Night Scene / Candlelight / Fireworks / Text / Sunset / Sunrise / Splash Water / Flow Water / Snow / Beach / Pets / Natural Green / User Setting

Size

This sets the size of the image that will be captured.

-  5M (2560 x 1920 pixels)
-  3M (2048 x 1536 pixels)
-  1.2M (1280 x 960 pixels)
-  VGA (640 x 480 pixels)

Quality

This sets the quality (compression) at which the image is captured.

-  Fine
-  Standard
-  Economy

Sharpness

This sets the sharpness of the image that will be captured.

- Hard / Standard / Soft

Saturation

This sets the saturation of the image that will be captured.

- High / Standard / Low

W. Balance

This sets the white balance for a variety of lighting conditions and permits images to be captured that approach the conditions that are seen by the human eye.

- [Blank] Auto
- [☀️] Incand.
- [💡] Fluoresc.1
- [💡] Fluoresc.2
- [☀️] Daylight
- [☁️] Cloudy
- [👤] Manual WB

ISO

This sets the sensitivity for capturing images. When the sensitivity is raised (and the ISO figure is increased), photography will become possible even in dark locations, but the image will appear more pixelated (grainier).

- Auto / 50 / 100 / 200 / 400

Metering

This sets the metering method for calculating the exposure.

- [☐] Center: Averages the light metered from the entire frame, but gives greater weight to the subject matter at the center.
- [◻] Spot: A very small portion of the center of the screen is measured, and the exposure is calculated.
- [■] Average: The entire area of the screen is measured, and the exposure is calculated.

Color

This sets the color of the image that will be captured.

- Standard / Vivid / Sepia / B&W / Blue / Red / Green / Yellow / Purple

Quick Shot

In case of pressing S2 (the shutter button down fully) fast at "Quick Shot on" mode, camera takes image without focus. However, if you set "Quick Shot off", the auto focus function works even if you press S2 fast.

- On / Off

Digi. Zoom

This sets whether or not to use digital zoom at the time of photography.

- On / Off

Preview

This sets whether or not to display the captured image on the screen immediately after the image is captured.

- On / Off

Date Print



The date of recording can be printed directly on the still images. This function must be activated before the image is captured.

- On / Off

MENU OPTIONS

Video Menu

This menu is for the basic settings to be used when recording video clips.

1. Toggle the  button to [].
2. Press the **MENU** button.
3. Select the desired option item with the **▲** / **▼** buttons, and press the **SET** button to enter its respective menu.
4. Select the desired setting with the **▲** / **▼** buttons, and press the **SET** button.
5. To exit from the menu, press the **MENU** button.



Size

This sets the size of the video clip that will be captured.

- [VGA] VGA (640 x 480 pixels)
- [QVGA] QVGA (320 x 240 pixels)

Quality

This sets the quality (compression) at which the video clip is captured.

- [Fine] Fine
- [Standard] Standard

Color

This sets the color of the video clip that will be captured.

- Standard / Vivid / Sepia / B&W / Blue / Red / Green / Yellow / Purple

Audio

This enables or disables the audio recording when recording video clips.

- On / Off

Digi. Zoom

Refer to section in this manual titled "Digital Zoom" in Capture Menu for further details.

MENU OPTIONS

Playback Menu

In the [RECALL] mode, choose which settings are to be used for playback.

1. Press the [RECALL] button.
2. Press the **MENU** button.
3. Select the desired option item with the \blacktriangle / \blacktriangledown buttons, and press the **SET** button to enter its respective menu.
4. Select the desired setting with the \blacktriangle / \blacktriangledown buttons, and press the **SET** button.
5. To exit from the menu, press the **MENU** button.



Delete

Use this function to delete one or all images/movie clips stored in SD memory card or the internal memory. Please note that the deleted images or movie clips cannot be recovered.

- Single / All

Fix Red Eyes

Refer to section in this manual titled "Removing Red-eye" for further details.

Slide Show

You can play back recorded images in order with a selected interval.

- 3 Sec. / 5 Sec. / 10 Sec.

Rotate

If you wish to rotate a still image 90 degrees to the right, select +90°; if you wish to rotate it 90 degrees to the left, select -90°. Video clips cannot be rotated.

- +90° / -90°

DPOF

DPOF is the abbreviation for Digital Print Order Format, which allows you to embed printing information on your memory card. You can select the images to be printed and how many prints to make with the DPOF menu in the camera and insert the memory card to the card compatible printer. When the printer starts printing, it will read the embedded information on the memory card and print the specified images.

- Single / All

Protect

Set the data to read-only to prevent images from being erased by mistake.

- Single / All

Voice Memo

A maximum of 30 seconds of audio can be recorded as a memo for captured still images. The voice memo can be recorded only once. This camera does not have a built-in speaker so that you can not play back sound with the camera.

- On / Off

Copy to Card

Allows you to copy your files from the camera's internal memory to an SD/SDHC memory card. Of course, you can only do this if you have a memory card installed and some files in internal memory.

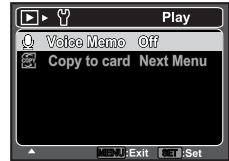

Setup Menu

Set your camera's operating environment.

1. Toggle the **MODE** button to [📷] or [📹]; or press the [▶] button.
2. Press the **MENU** button.
3. Select the [Setup] menu with the ▶ button.
4. Select the desired option item with the ▲ / ▼ buttons, and press the **SET** button to enter its respective menu.
5. Select the desired setting with the ▲ / ▼ buttons, and press the **SET** button.
6. To exit from the menu, press the **MENU** button.

Date/Time

This sets the camera's date and the time.

Language

Specify in which language menus and messages are to be displayed on the LCD monitor.

Auto Off

If no operation is performed for a specific period of time, the power to the camera is automatically turned off. This feature is useful for reducing battery usage.

- 1 Min. / 2 Min. / 3 Min. / Off

Beep

This sets whether or not to mute the camera sound each time you press the camera's buttons.

- On / Off

Display

This sets the image information display state.

- Default / All / Off

Fr. No. Reset

This creates a new folder. The captured images are recorded to the newly created folder from number 0001.

LCD Bright.

Select a brightness level for the LCD monitor.

The LCD becomes brighter with the ▲ button and darker with the ▼ button. The adjustment range is from -5 to 5.

Light Freq.

This camera supports different lighting frequencies: 50 Hz and 60 Hz. When photographing under fluorescent lighting, select the correct frequency setting depending in your local area's voltage. This function is only effective if you set the White Balance to Fluorescent setting.

- 50 Hz / 60 Hz

Format

This utility formats the internal memory (or memory card) and erases all stored images and data.

Media Info.

This displays the free capacity of the internal memory or the memory card.

Sys. Info.

This displays the firmware version of the camera.

Sys. Reset

- This returns all basic settings to the camera's default settings. The time setting will not be reset.



System Requirement

Windows	Macintosh
<ul style="list-style-type: none"> ■ Pentium III 1GHz or equivalent ■ Windows 2000/XP/Vista ■ 512MB RAM ■ 150MB available hard disk space ■ CD-ROM drive ■ Available USB port 	<ul style="list-style-type: none"> ■ PowerPC G3/G4/G5 ■ OS 9.0 or later ■ 256MB RAM (512 MB recommended) ■ 128MB available hard disk space ■ CD-ROM drive ■ Available USB port

Downloading Your Files

1. Connect one end of the USB cable to an available USB port on your computer.
2. Connect the other end of the USB cable to the USB terminal on the camera.
3. Turn on your camera.
4. Select [PC] using the ▲ / ▼ buttons and press the **SET** button.
5. From the Windows desktop, double click on "My Computer".
6. Look for a new "removable disk" icon.
 - This "removable disk" is actually the memory (or memory card) in your camera. Typically, the camera will be assigned drive letter "e" or higher.
7. Double click on the removable disk and locate the DCIM folder.
8. Double click on the DCIM folder to open it to find more folders.
 - Your recorded images and video clips will be inside these folders.
9. Copy & Paste or Drag-N-Drop image and video files to a folder on your computer.

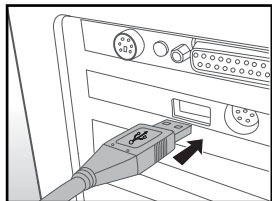

Mac users: Double-click the "untitled" or "unlabeled" disk drive icon on your desktop. iPhoto may automatically launch.

USING THE CAMERA AS A PC CAMERA **10**

Your camera can act as a PC camera, which allows you to videoconference with business associates, or have a real-time conversation with friends or family.

1. After installing the PC camera driver (included on the CD-ROM) in your Windows operating system, restart your computer.
2. Connect one end of the USB cable to the USB terminal of the camera.
3. Connect the other end of the USB cable to an available USB port on your computer.
4. Turn on your camera.
5. Select [PC Camera] with the ▲ / ▼ buttons and press the **SET** button.
6. Position the camera steadily on top of your computer monitor or use a tripod.
7. Launch the videoconferencing application software.
 - Simply follow the instructions in the application software to start your camera.



- This function is not supported by Mac.
- You are recommended to use Windows Netmeeting (Windows Meeting Space on Windows Vista) as a videoconferencing application software.
- The video resolution for videoconferencing applications is generally 320 x 240.
- For more information about the operation of videoconference application software, refer to its respective help documentation.
- Video conferencing (or video editing) software is not included with the camera.

EDITING SOFTWARE INSTALLATION



There are 2 types of software that are included on the CD-ROM:

ArcSoft MediaImpression™ - manages your media for you, and gives you tons of fun and exciting ways to create and share projects featuring your photo, video, and music files. Create your own movies or photo slide shows, complete with soundtrack; edit, enhance, and add fun creative effects to your photos; and share your files easily through simple email attachments or popular photo printing and video sharing websites.

Print Creations - brings you a family of fun and easy print-project software that brings out the creativity in you. You can personalize the designs with your own digital pictures and text based on professionally designed templates and layouts. Projects can be printed at home or saved as image files for sharing with family and friends by email or the web.

To install software:

1. Insert the CD-ROM that came with the camera into your CD-ROM drive.
The welcome screen appears.
2. Click the respective software name.
Follow the on-screen instructions to complete the installation.



- For more information about the operation of the software, refer to its respective help documentation.
- For Windows 2000/XP/Vista users, please make sure to install and use the software in "Administrator" mode.
- The software is not supported by Mac.

SPECIFICATIONS

Item	Description
Image sensor	1/3.2" CMOS sensor (5.0 megapixels)
Image resolution	<Still image> 5M (2560 x 1920), 3M (2048 x 1536) 1.2M (1280 x 960), VGA (640 x 480) <Video clip> VGA(640 x 480)(24fps), QVGA(320 x 240)(30fps)
LCD monitor	2.36" LTPS-TFT LCD (112K pixels)
Recording media	32MB internal memory (28MB available for image storage) Supports SD/SDHC memory card (up to 8GB)
File format	JPEG, DCF, EXIF 2.2, DPOF, AVI, ADPCM (WAV)
Lens	3x optical zoom lens Aperture range: 2.7 (W) - 4.7 (T) Focal length: 6.1mm - 18.3mm (equivalent to 46mm - 140mm on a 35mm camera)
Focus Range	Macro Wide: 0.05m to infinity Tele: 0.35m to infinity Normal 0.4m to infinity
Shutter speed	1/2 - 1/1000 sec.
ISO Sensitivity	Auto / 50 / 100 / 200 / 400
Digital zoom	4x (Capture mode) 1-4x in 0.5x increment (Playback mode)
Flash effective range	0.6m - 2.7m
Terminal	USB 2.0 High Speed
Power supply	2 x AA size batteries
Dimensions	Approx. 89.5 x 61 x 28.8mm (without protruding parts)

- Design and specifications are subject to change without notice.

Connecting to a PictBridge Compatible Printer

Read this section if the model you purchased is included with the PictBridge functions. If a printer that supports PictBridge is available, images can be printed by connecting the digital still camera directly to the PictBridge-compatible printer without using a computer.

Connecting the camera to the printer

1. Connect one end of the USB cable to your camera.
2. Connect the other end of the USB cable to the USB port on the printer.
3. Turn on your camera.
4. Select [PictBridge] with the ▲ / ▼ buttons, and press the **SET** button.

Printing images

When the camera is properly connected to a PictBridge compliant printer and set to [PictBridge], the PictBridge menu is displayed on the monitor.

1. Select the item you want to configure with the ▲ / ▼ buttons, and press the **SET** button.
 - [Images]: Select whether you want to print specific image or all images. You may also select printing number for specific image.
 - [Date Print]: According to the printer type, select whether you want to print the image with date imprint or not.
 - [Paper Size]: Select the desired paper size according to the printer type.
 - [Layout]: Select the desired printing layout according to the printer type.
 - [Print]: After all settings are configured, select this item to start printing.
2. If you select [Images] in the previous step, the figure shown on the right hand side will appear.
 - Select [Single], [All], [DPOF] with the ▲ / ▼ buttons, and press the **SET** button.
3. If you select [Single] in the previous step:
 - Select the image that you want to print with the ◀ / ▶ buttons.
 - Select the [Print Num] (up to 99) with the ▲ / ▼ buttons.
 - After selecting the desired image and printing number, press the **SET** button to confirm.
4. Select [Print] with the ▲ / ▼ buttons, and press the **SET** button to start printing.
 - The [COMPLETE] will be displayed temporarily, reminding you that the printing procedure is finished.
 - If a print error is detected, the [PRINT ERROR] will be displayed.

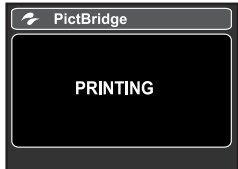
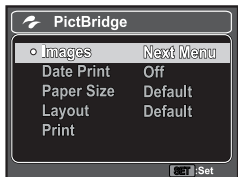



- The image printing may be failed if the power to the camera is cut off.
- With this [You Tube] function, we can upload our image and video to "You Tube" net easily.



Electrical and electronic equipment (EEE) contains materials, parts and substances which can be dangerous to the environment and harmful to human health if waste of electrical and electronic equipment (WEEE) is not disposed of correctly.



Equipment which is marked with the WEEE logo (as shown on the left), should not be thrown away with your household waste. Contact your Local Authority Waste Disposal Department as they will be able to provide details of the recycling options available in your area.



If your used electrical or electronic equipment has batteries or accumulators, please dispose of these separately beforehand according to local requirements.

By disposing of this product correctly you will help ensure that the waste undergoes the necessary treatment, recovery and recycling and thus prevent potential negative effects on the environment and human health which could otherwise arise due to inappropriate waste handling.

TRAVELER 5 MP DIGITAL CAMERA
3x optical zoom

3 YEAR WARRANTY CARD

Name _____

Address _____

Email _____ Tel No _____

Model No. FX 5 _____

Location of purchase _____

Please send your completed Warranty Card to:

UK

SUPRA

Foto-Elektronik-Vertriebs GmbH
Denisstraße 28 A
D-67663 Kaiserslautern
Germany
Telephone 00 800 - 78 77 23 68
Fax 00 49 6 31 - 3 51 99 49

Ireland

SUPRA

Foto-Elektronik-Vertriebs GmbH
Denisstraße 28 A
D-67663 Kaiserslautern
Germany
Telephone 00 800 - 78 77 23 68
Fax 00 49 6 31 - 3 51 99 49

Free Manuals Download Website

<http://myh66.com>

<http://usermanuals.us>

<http://www.somanuals.com>

<http://www.4manuals.cc>

<http://www.manual-lib.com>

<http://www.404manual.com>

<http://www.luxmanual.com>

<http://aubethermostatmanual.com>

Golf course search by state

<http://golfingnear.com>

Email search by domain

<http://emailbydomain.com>

Auto manuals search

<http://auto.somanuals.com>

TV manuals search

<http://tv.somanuals.com>