

Trimble® R7/R8 GPS Receiver

User Guide



Version 2.10 (R7), 2.11 (R8)
Revision A
June 2004

Corporate Office

Trimble Navigation Limited
Engineering and Construction Division
5475 Kellenburger Road
Dayton, Ohio 45424-1099
U.S.A.

Copyright and Trademarks

© 2001-2004, Trimble Navigation Limited. All rights reserved.

Trimble, the Globe & Triangle logo, and GPS Total Station are trademarks of Trimble Navigation Limited, registered in the United States Patent and Trademark Office and other countries. eRTK, Micro-Centred, SiteNet, Trimble Geomatics Office, Trimble Survey Controller, Trimble Survey Pro, TRIMMARK, TRIMTALK, TSC1, TSCe, and Zephyr are trademarks of Trimble Navigation Limited.

The Bluetooth word mark and logos are owned by the Bluetooth SIG, Inc. and any use of such marks by Trimble Navigation Limited is under license

Microsoft and Windows are either registered trademarks or trademarks of Microsoft Corporation in the United States and/or other countries.

All other trademarks are the property of their respective owners.

Release Notice

This is the June 2004 release (Revision A) of the *Trimble R7/R8 GPS Receiver User Guide*. It applies to version 2.10 (R7) and 2.11 (R8) of the Trimble R7/R8 GPS receivers.

The following limited warranties give you specific legal rights. You may have others, which vary from state/jurisdiction to state/jurisdiction.

Hardware Limited Warranty

Trimble warrants that this Trimble hardware product (the "Product") shall be free from defects in materials and workmanship and will substantially conform to Trimble's applicable published specifications for the Product for a period of one (1) year, starting from the date of delivery. The warranty set forth in this paragraph shall not apply to software/firmware products.

Software and Firmware License, Limited Warranty

This Trimble software and/or firmware product (the "Software") is licensed and not sold. Its use is governed by the provisions of the applicable End User License Agreement ("EULA"), if any, included with the Software. In the absence of a separate EULA included with the Software providing different limited warranty terms, exclusions, and limitations, the following terms and conditions shall apply. Trimble warrants that this Trimble Software product will substantially conform to Trimble's applicable published specifications for the Software for a period of ninety (90) days, starting from the date of delivery.

Warranty Remedies

Trimble's sole liability and your exclusive remedy under the warranties set forth above shall be, at Trimble's option, to repair or replace any Product or Software that fails to conform to such warranty ("Nonconforming Product"), or refund the purchase price paid by you for any such Nonconforming Product, upon your return of any Nonconforming Product to Trimble in accordance with Trimble's standard return material authorization procedures.

Warranty Exclusions and Disclaimer

These warranties shall be applied only in the event and to the extent that: (i) the Products and Software are properly and correctly installed, configured, interfaced, maintained, stored, and operated in accordance with Trimble's relevant operator's manual and specifications, and; (ii) the Products and Software are not modified or misused. The preceding warranties shall not apply to, and Trimble shall not be responsible for defects

or performance problems resulting from (i) the combination or utilization of the Product or Software with products, information, data, systems or devices not made, supplied or specified by Trimble; (ii) the operation of the Product or Software under any specification other than, or in addition to, Trimble's standard specifications for its products; (iii) the unauthorized modification or use of the Product or Software; (iv) damage caused by accident, lightning or other electrical discharge, fresh or salt water immersion or spray; or (v) normal wear and tear on consumable parts (e.g., batteries).

THE WARRANTIES ABOVE STATE TRIMBLE'S ENTIRE LIABILITY, AND YOUR EXCLUSIVE REMEDIES, RELATING TO PERFORMANCE OF THE PRODUCTS AND SOFTWARE. EXCEPT AS OTHERWISE EXPRESSLY PROVIDED HEREIN, THE PRODUCTS, SOFTWARE, AND ACCOMPANYING DOCUMENTATION AND MATERIALS ARE PROVIDED "AS-IS" AND WITHOUT EXPRESS OR IMPLIED WARRANTY OF ANY KIND BY EITHER TRIMBLE NAVIGATION LIMITED OR ANYONE WHO HAS BEEN INVOLVED IN ITS CREATION, PRODUCTION, INSTALLATION, OR DISTRIBUTION, INCLUDING, BUT NOT LIMITED TO, THE IMPLIED WARRANTIES OF MERCHANTABILITY AND FITNESS FOR A PARTICULAR PURPOSE, TITLE, AND NONINFRINGEMENT. THE STATED EXPRESS WARRANTIES ARE IN LIEU OF ALL OBLIGATIONS OR LIABILITIES ON THE PART OF TRIMBLE ARISING OUT OF, OR IN CONNECTION WITH, ANY PRODUCTS OR SOFTWARE. SOME STATES AND JURISDICTIONS DO NOT ALLOW LIMITATIONS ON DURATION OR THE EXCLUSION OF AN IMPLIED WARRANTY, SO THE ABOVE LIMITATION MAY NOT APPLY TO YOU.

TRIMBLE NAVIGATION LIMITED IS NOT RESPONSIBLE FOR THE OPERATION OR FAILURE OF OPERATION OF GPS SATELLITES OR THE AVAILABILITY OF GPS SATELLITE SIGNALS.

Limitation of Liability

TRIMBLE'S ENTIRE LIABILITY UNDER ANY PROVISION HEREIN SHALL BE LIMITED TO THE GREATER OF THE AMOUNT PAID BY YOU

FOR THE PRODUCT OR SOFTWARE LICENSE OR U.S.\$25.00. TO THE MAXIMUM EXTENT PERMITTED BY APPLICABLE LAW, IN NO EVENT SHALL TRIMBLE OR ITS SUPPLIERS BE LIABLE FOR ANY INDIRECT, SPECIAL, INCIDENTAL, OR CONSEQUENTIAL DAMAGES WHATSOEVER UNDER ANY CIRCUMSTANCE OR LEGAL THEORY RELATING IN ANY WAY TO THE PRODUCTS, SOFTWARE, AND ACCOMPANYING DOCUMENTATION AND MATERIALS, (INCLUDING, WITHOUT LIMITATION, DAMAGES FOR LOSS OF BUSINESS PROFITS, BUSINESS INTERRUPTION, LOSS OF BUSINESS INFORMATION, OR ANY OTHER PECUNIARY LOSS), REGARDLESS OF WHETHER TRIMBLE HAS BEEN ADVISED OF THE POSSIBILITY OF ANY SUCH LOSS AND REGARDLESS OF THE COURSE OF DEALING WHICH DEVELOPS OR HAS DEVELOPED BETWEEN YOU AND TRIMBLE. BECAUSE SOME STATES AND JURISDICTIONS DO NOT ALLOW THE EXCLUSION OR LIMITATION OF LIABILITY FOR CONSEQUENTIAL OR INCIDENTAL DAMAGES, THE ABOVE LIMITATION MAY NOT APPLY TO YOU.

Regulations and Safety

The Bluetooth module inside your receiver is a radio-modem transmitter and receiver.

Regulations regarding the use of the radio-modems vary greatly from country to country. In some countries, the unit can be used without obtaining an end-user license. Other countries require end-user licensing. Consult your local communications governing agency for licensing information.

Before operating this receiver, determine if authorization or a license to operate the unit is required in your country. It is the responsibility of the end user to obtain an operator's permit or license for this receiver radio-modem for the location or country of use.

STATEMENT ACCORDING FCC PART 15.19

This device complies with Part 15 of the FCC Rules. Operation is subject to the following two conditions: (1) this device may not cause harmful interference, and (2) this device must accept any interference received, including interference that may cause undesired operation.

STATEMENT ACCORDING FCC PART 15.21

Modifications not expressly approved by Trimble could void the user's authority to operate the equipment.

STATEMENT ACCORDING FCC PART 15.105

This equipment has been tested and found to comply with the limits for a Class B digital device, pursuant to Part 15 of the FCC Rules. These limits are designed to provide reasonable protection against harmful interference in a residential installation. This equipment generates, uses and can radiate radio frequency energy and, if not installed and used in accordance with the instructions, may cause harmful interference to radio communications. However, there is no guarantee that interference will not occur in a particular installation. If this equipment does cause harmful interference to radio or television reception, which can be determined by turning the equipment off and on, the user is encouraged to try to correct the interference by one or more of the following measures:

- Reorient or relocate the receiving antenna.
- Increase the separation between the equipment and receiver.
- Connect the equipment into an outlet on a circuit different from that to which the receiver is connected.
- Consult the dealer or an experienced radio/TV technician for help.

Type Approval

Type approval, or acceptance, covers technical parameters of the equipment related to emissions that can cause interference. Type approval is granted to the manufacturer of the transmission equipment, independent from the operation or licensing of the units. Some countries have unique technical requirements for operation in particular radio-modem frequency bands. To comply with those requirements, Trimble may have modified your equipment to be granted Type approval. Unauthorized modification of the units voids the Type approval, the warranty, and the operational license of the equipment.

Safety

EXPOSURE TO RADIO FREQUENCY RADIATION

You must maintain a minimum separation distance of 20 cm (approximately 8 in.) between yourself and the radiating GSM antenna for this device to satisfy the RF Exposure requirements of the FCC.

For mobile operation, the maximum gain of the GSM antenna must not exceed 0 dBi.

Contents

1	Introduction	1
	Related Information	1
	Warnings and Cautions	2
	Technical Assistance	3
	Your Comments	3
	Trimble R7 GPS Receiver	
2	Overview	7
	Introduction	8
	Features	8
	Use and Care	9
	COCOM Limits	10
3	Setting up the Receiver	11
	Introduction	12
	Parts of the Receiver	12
	Front panel	13
	Rear panel	14
	Top panel	15
	Bottom panel	17
	Setup Guidelines	18
	Environmental conditions	18
	Sources of electrical interference	18
	General guidelines	19
	Postprocessed Setup.	20

Pole-Mounted Setup	22
Backpack Setup	28
Other System Components	30
Radios	30
Cellular modems	33
Antennas	35
CompactFlash cards	36
4 General Operation	37
Introduction	38
Button Functions	38
LED Behavior	39
Logging/Memory LED	40
SV Tracking LED	40
Radio LED	41
Battery 1 LED and Battery 2 LED	41
Starting and Stopping the Receiver	41
Logging Data	42
Logging internally	42
Logging to a Trimble controller	43
Resetting to Defaults	43
Formatting a CompactFlash Card	44
Batteries and Power	45
Battery charging and storage	47
Operating with the TSC1/TSCe controller	48
Power output	49
Firmware	50
5 Configuration	53
Introduction	54
Configuring the Receiver in Real Time	54
Configuring the Receiver Using Application Files	55
Application Files	55

Special application files	56
Timed application files	58
Applying application files	59
Storing application files	59
Naming application files	60
6 Transferring Data	61
Introduction	62
Connecting to the Office Computer.	63
Transferring Data	65
Transferring Files Directly from a CompactFlash Card	66
Deleting Files in the Receiver.	68
Supported File Types	68
7 Software Utilities.	69
Introduction	70
GPS Configurator Software.	70
Installing GPS Configurator	70
Configuring the Trimble R7 receiver.	71
WinFlash Software	71
Installing WinFlash.	72
Upgrading firmware	72
Adding frequencies for the 450 MHz internal radio	74
Configuring the internal 900 MHz radio setup.	76
8 Specifications	79
Introduction	80
Physical Specifications	80
Positioning Specifications.	81
Technical Specifications	82
9 Default Settings	83
Introduction	84
Default Settings	85

Resetting to Factory Defaults	86
Examples	87
Default behavior	87
Power up settings.	88
Logging after power loss.	89
Disabling logging	89
Application files	90
10 Cables and Connectors	91
Introduction	92
Port 1, 2, and 3 Connectors	92
Power/serial data cable	94
Event Marker/1PPS Cable	95
GPS Antennas and Cables	97
11 Event Marker Input and 1PPS Output	99
Introduction	100
Event Marker Input	100
Enabling and configuring event marker input	100
1PPS Output.	102
1PPS pulse definition	102
ASCII time tag definition	103
Enabling and configuring 1PPS output	104
 Trimble R8 GPS Receiver	
12 Overview	109
Introduction	110
Features	110
Use and Care	112
COCOM Limits.	112
13 Setting up the Receiver	113
Introduction	114

Parts of the Receiver	114
Front panel	114
Lower housing	115
Setup Guidelines	117
Environmental conditions	117
Sources of electrical interference	117
General guidelines	118
Pole-Mounted Setup	118
Other System Components	119
Radios	119
Cellular modems and external radios	121
14 General Operation	123
Introduction	124
Button Functions	125
LED Behavior	125
LED flash patterns	126
Starting and Stopping the Receiver	126
Logging Data	127
Logging internally	127
Logging to a Trimble controller	128
Resetting to Defaults	128
Batteries and Power	129
Battery charging and storage	130
Power output	131
Firmware	132
15 Configuration	133
Introduction	134
Configuring the Receiver in Real Time	134
Configuring the Receiver Using Application Files	135
Application Files	135
Special application files	136

Applying application files	138
Storing application files	138
Naming application files	138
16 Software Utilities.	139
Introduction	140
GPS Configurator Software.	140
Installing GPS Configurator	140
Configuring the Trimble R8 receiver.	141
WinFlash Software	141
Installing WinFlash.	142
Upgrading firmware	142
Adding frequencies for the 450 MHz internal radio	144
Configuring the internal 900 MHz radio setup.	146
Configuring the internal transceiver	148
17 Specifications	151
Introduction	152
Physical Specifications	152
Positioning Specifications.	153
Technical Specifications	154
18 Default Settings	157
Introduction	158
Default Settings	159
Resetting to Factory Defaults	160
Default behavior	160
Power up settings.	160
19 Cables and Connectors	161
Introduction	162
Port 1 and 2 Connectors.	162
Power/Serial Data Cables	164

Appendixes
Trimble R7 / Trimble R8

A NMEA-0183 Output 169
 Introduction 170
 NMEA-0183 Outputs 170
 Common Message Elements 172
 Message values. 172
 NMEA Messages 173

B RTCM Output. 189
 RTCM Output 190
 Message Scheduling 191

C Troubleshooting 193

Index 199

Introduction

Welcome to the *Trimble R7/R8 GPS Receiver User Guide*. This manual describes how to install, set up, and use a Trimble® R7 or Trimble R8 GPS receiver.

Even if you have used other Global Positioning System (GPS) products before, Trimble recommends that you spend some time reading this manual to learn about the special features of this product.

If you are not familiar with GPS, visit our website for an interactive look at Trimble and GPS at:

- www.trimble.com

Trimble assumes that you are familiar with the Microsoft® Windows® operating system and know how to use a mouse, select options from menus and dialogs, make selections from lists, and refer to online help.

Related Information

An electronic copy of this manual is available in portable document format (PDF) on the *Trimble R7, Trimble R8, 5700, and 5800 GPS Receiver CD*. Use Adobe Reader to view the contents of this file.

Other sources of related information are:

- Release notes – the release notes describe new features of the product, information not included in the manual, and any changes to the manual. They are provided as a PDF on the CD. Use Adobe Reader to view the contents of the release notes.
- Registration – register your receiver to automatically receive e-mail notifications of Trimble R7 receiver firmware upgrades and new functionality. To register, do one of the following:
 - Run the *Trimble R7, Trimble R8, 5700, and 5800 GPS Receiver CD*.
 - Register electronically via the internet by completing the form and submitting.
 - Print the registration form that is on the CD, fill it in, and fax or mail it to the address shown.

Contact your local Trimble Dealer for more information about the support agreement contracts for software and firmware, and an extended warranty program for hardware.

- Trimble training courses – consider a training course to help you use your GPS system to its fullest potential. For more information, visit the Trimble website at www.trimble.com/training.html

Warnings and Cautions

Always follow the instructions that accompany a warning or a caution.



WARNING – Alerts you to a situation that is likely to cause serious personal injury, irreparable damage to equipment, or unrecoverable data loss.



Caution – Alerts you to a hazard or an unsafe practice that could cause injury or property damage.

Technical Assistance

If you have a problem and cannot find the information you need in the product documentation, *contact your local Distributor*. Alternatively, request technical support using the Trimble website at:

- www.trimble.com/support.html

Your Comments

Your feedback about the supporting documentation helps us to improve it with each revision. E-mail your comments to ReaderFeedback@trimble.com.

1 Introduction

4 Trimble R7/R8 GPS Receiver User Guide

SECTION

I

TRIMBLE R7 GPS RECEIVER

Overview

In this chapter:

- Introduction
- Features
- Use and Care
- COCOM Limits

Introduction

This chapter introduces the Trimble R7 GPS receiver. This receiver is designed for GPS surveying applications. The receiver features one-touch logging for ease of use, and five LEDs that let you monitor the survey in progress and the available battery capacity.

The Trimble R7 tracks GPS satellites on both the L1 and L2 frequencies to provide precise position data for land survey applications. The receiver records GPS data on an internal CompactFlash card and makes all data available through serial or USB ports.

You can use the Trimble R7 alone by logging data internally, or as part of the GPS Total Station® system, which logs GPS data from the receiver to a Trimble controller running the Trimble Survey Controller™ or Trimble Survey Pro™ software.

Features

The receiver provides the following features:

- Trimble R-track technology, which allows the receiver to track the L2 Civil signal (L2C)
- Centimeter-accuracy real-time positioning with RTK/OTF data, and up to 10 Hz position updates
- Submeter-accuracy real-time positioning using pseudorange corrections
- Adaptive dual-frequency RTK engine
- WAAS/EGNOS capability (Wide Area Augmentation System/European Geo-Stationary Navigation System)
- Automatic OTF (on-the-fly) initialization while moving
- 1PPS (One Pulse Per Second) output
- Dual event-marker input

- USB port for data transfer
- Type I CompactFlash card for data storage
- Internal charging of batteries (no external battery charger required)
- Three RS-232 serial ports for:
 - NMEA output
 - RTCM SC-104 input and output
 - Trimble Format (CMR) input and output
- Two TNC ports for connecting to the GPS and radio antennas

Use and Care

The Trimble R7 is designed to withstand the rough treatment that typically occurs in the field. However, the receiver is a high-precision electronic instrument and should be treated with reasonable care.



WARNING – Operating or storing the receiver outside the specified temperature range can damage it. For more information, see Physical specifications, page 80.

High-power signals from a nearby radio or radar transmitter can overwhelm the receiver circuits. This does not harm the instrument, but it can prevent the receiver electronics from functioning correctly. Avoid using the receiver within 400 meters of powerful radar, television, or other transmitters. Low-power transmitters such as those used in cellphones and two-way radios normally do not interfere with receiver operations.

For more information, contact your local Trimble distributor.

COCOM Limits

The U.S. Department of Commerce requires that all exportable GPS products contain performance limitations so that they cannot be used in a manner that could threaten the security of the United States. The following limitations are implemented on the Trimble R7 receiver.

Immediate access to satellite measurements and navigation results is disabled when the receiver's velocity is computed to be greater than 1000 knots, or its altitude is computed to be above 18,000 meters. The receiver continuously resets until the COCOM situation is cleared.

Setting up the Receiver

In this chapter:

- Introduction
- Parts of the Receiver
- Setup Guidelines
- Postprocessed Setup
- Pole-mounted Setup
- Backpack Setup
- Other System Components

Introduction

This chapter provides general setup information, connection information, and cabling diagrams for the most common uses of the Trimble R7 receiver.

Parts of the Receiver

All operating controls, ports, and connectors on the receiver are located on its four main panels, as shown in Figure 3.1. This section provides a brief overview of the features of each of these panels.

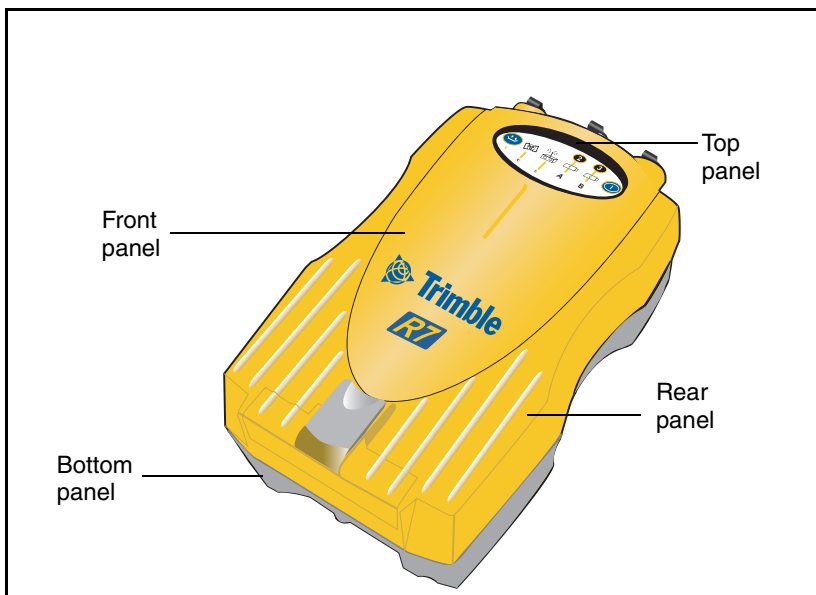

Figure 3.1 Panels on the Trimble R7 receiver

Front panel

Figure 3.2 shows the front panel of the Trimble R7. This panel contains the five indicator LEDs, the two buttons, and the catch for the CompactFlash/USB door.

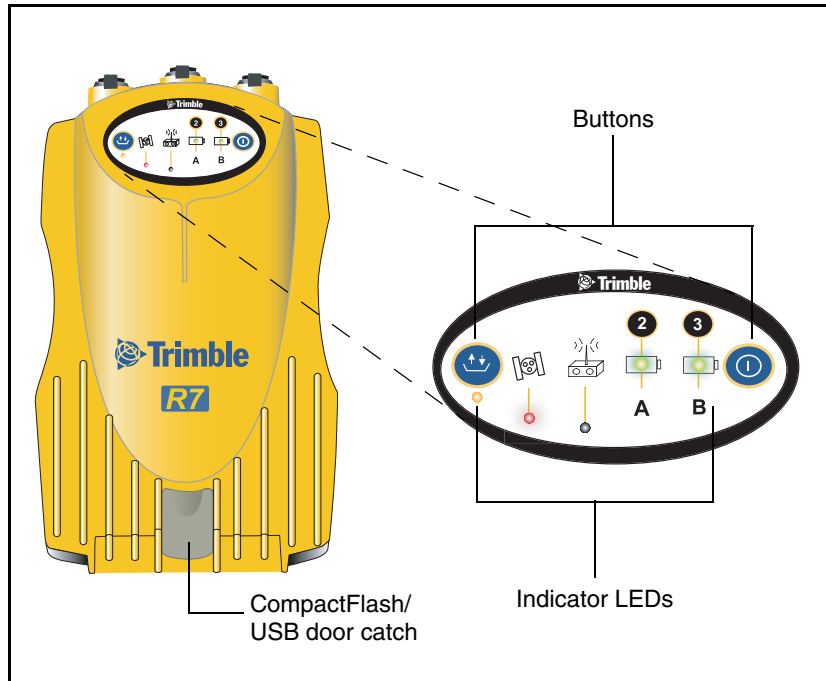

Figure 3.2 Front panel

The two buttons control data logging, data management, power, and settings. For more information, see [Button Functions](#), page 38.

The indicator LEDs show the status of logging, power, satellite tracking, and radio reception. For more information, see [LED Behavior](#), page 39.

Rear panel

Figure 3.3 shows the rear panel of the Trimble R7. This panel contains a slot for attaching the receiver catch lock, and the catches for the two battery compartments on the bottom panel. The catch lock should already be attached to your receiver.

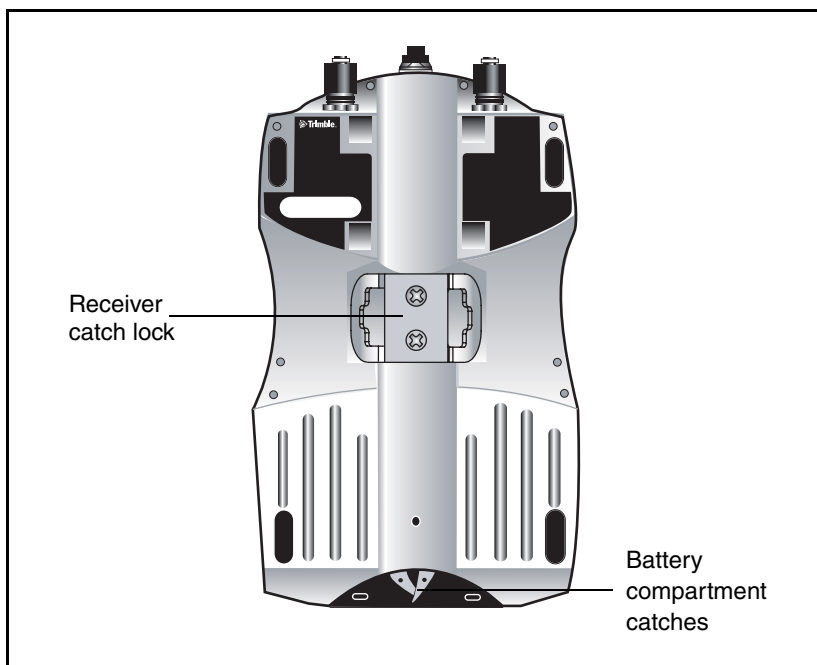

Figure 3.3 Rear panel

To mount the receiver on a pole, you need to attach the receiver bracket to the pole and insert the catch lock into the bracket. For more information, see Pole-Mounted Setup, page 22.

Top panel

Figure 3.4 shows the top panel of the Trimble R7. This panel contains the three power/serial data ports and (TNC) ports for GPS and radio antenna connections.

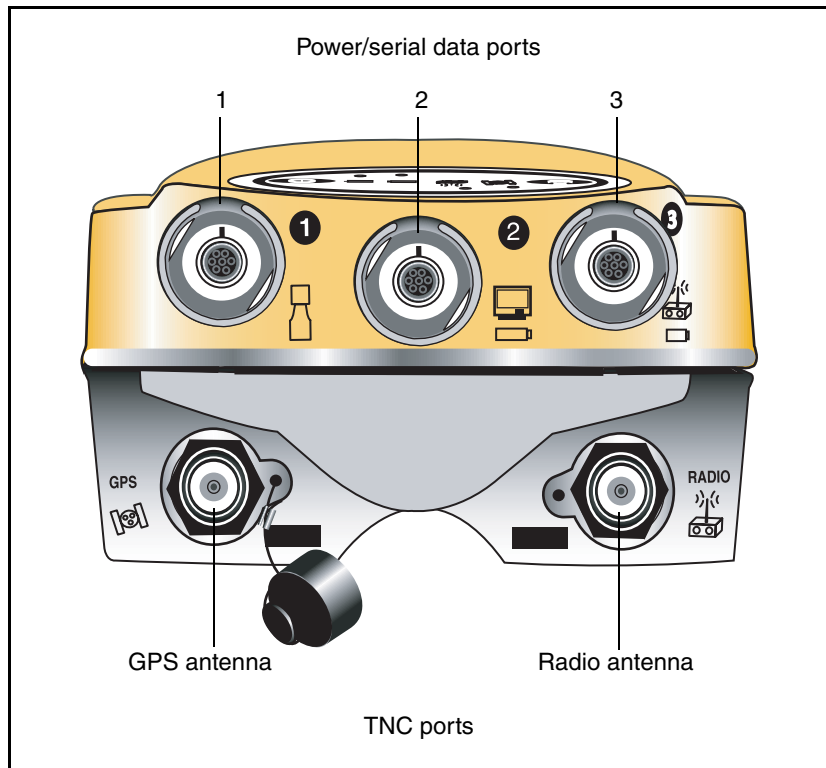







Figure 3.4 Top panel

3 Setting up the Receiver

Each port on the top panel is marked with an icon to indicate its main function.

Table 3.1 Trimble R7 receiver ports

Icon	Name	Connections
	Port 1	Trimble controller, event marker, or computer
	Port 2	Power in, computer, 1PPS, or event marker
	Port 3	External radio, power in
	GPS	GPS antenna
	RADIO	Radio communications antenna

The power/serial data ports are all 7 pin 0-shell Lemo connectors. Both Port 2 and Port 3 can accept external power. For information on default port settings, see *Default Settings*, page 85. For information on connector pinouts, see *Cables and Connectors*, page 91.

The TNC port connectors are color-coded for easy system setup. Connect the yellow GPS antenna cable to the yellow TNC port marked GPS, and connect the blue Range Pole antenna (RPA) cable to the blue TNC connector marked RADIO. For more information on connecting the Trimble R7 system, see the following sections in this chapter.

Bottom panel

Figure 3.5 shows the bottom panel of the Trimble R7. This panel contains the USB port, the CompactFlash port, and the compartments for the two internal batteries.

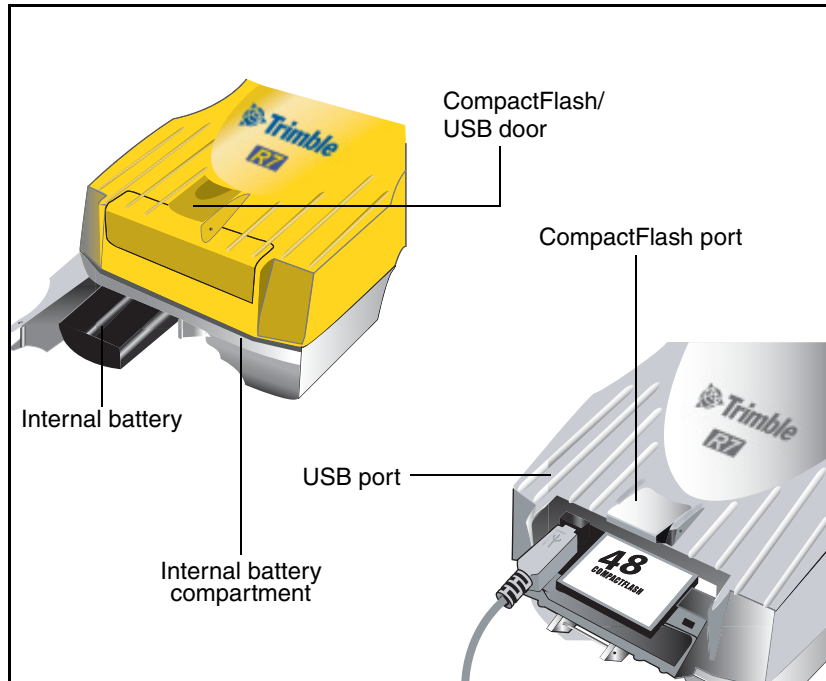

Figure 3.5 Bottom panel

The CompactFlash/USB door conceals the CompactFlash port and USB port. To open the door, push the catch on the front panel down.



WARNING – When no USB cable is connected, or when using the receiver in a harsh environment, keep this door closed to keep moisture, dust, and dirt out of the ports. The temperature rating of the receiver applies only when all doors on the receiver are closed.

Setup Guidelines

Consider the following guidelines when setting up the Trimble R7.

Environmental conditions

Although the Trimble R7 has a waterproof housing, reasonable care should be taken to keep the unit dry. Avoid exposure to extreme environmental conditions, including:

- Water
- Heat greater than 65° C (149° F)
- Cold less than -40° C (-40° F)
- Corrosive fluids and gases

Avoiding these conditions improves the receiver performance and long-term reliability.

Sources of electrical interference

Avoid the following sources of electrical and magnetic noise:

- Gasoline engines (spark plugs)
- Televisions and PC monitors
- Alternators and generators
- Electric motors
- Equipment with DC-to-AC converters
- Fluorescent lights
- Switching power supplies

General guidelines

The following guidelines apply whenever you set up your receiver for operation:

- When plugging in a Lemo cable, make sure that the red dots on the receiver port and the cable connector line up. *Never* use force to plug cables in, as this may damage the connector pins.
- When disconnecting a Lemo cable, grasp the cable by the sliding collar or lanyard and pull the cable connector straight out of the port. Do not twist the connector or pull on the cable itself.
- To securely connect a TNC cable, align the cable connector with the receiver receptacle and thread the cable connector onto the receptacle until snug.
- Insert the internal batteries with the battery contacts facing the CompactFlash/USB door. The undersides of the batteries have a center groove for alignment when being inserted into the receiver.

Postprocessed Setup

For a postprocessed survey, you only need:

- the Trimble R7 receiver
- a Zephyr™ or Zephyr Geodetic antenna
- a GPS antenna cable

Other equipment, as described below, is optional.

To set up the Trimble R7 for a postprocessed survey:

1. Set up the tripod with the tribrach and antenna adapter over the survey mark.

Instead of a tripod, you can use a range pole with a bipod.

However, Trimble recommends that you use a tripod for greater stability.

2. Mount the antenna on the tribrach adapter.
3. Use the tripod clip to hang the receiver on the tripod.
4. Connect the yellow GPS antenna cable to the Zephyr antenna.
5. Connect the other end of the GPS antenna cable to the yellow TNC port on the receiver.
6. If external power is required, connect a battery with a 0-shell Lemo connection to Port 2 or Port 3 on the receiver.

Figure 3.6 shows the Trimble R7 receiver postprocessed setup.



Figure 3.6 Postprocessed setup

***Note** – Instead of hanging the receiver on the tripod, you can place the receiver in its base case. Run the antenna cable out of the portal in the side of the base case to the antenna so that the case can stay closed while the receiver is running.*

Pole-Mounted Setup

To mount the Trimble R7 on a pole, you need to do the following:

1. Mount the eRTK™ Range Pole antenna (RPA).
2. Mount the receiver.
3. Mount the Trimble controller.

This section provides detailed instructions on each of these three steps.

Mounting the Range Pole antenna (RPA)

To mount the RPA on the pole:

1. Install the RPA bracket 7.5 cm (3") from the pole top by placing the two pieces together and securing with screws. If you are using a 1" diameter pole, place the bracket inserts inside the bracket before securing.

Note – You can use a quarter-wave whip (“rubber duck”) antenna attached directly to the receiver instead of the RPA.

2. Connect the yellow TNC-to-TNC GPS cable and run it through the RPA bracket clips where it is labeled on the bracket. Make sure that the right-angle connector is at the top.

Note – The cable must be routed inside the RPA, through the bracket, or it will affect the RPA radio reception performance.

3. Align the TNC connector on the RPA with the GPS antenna cable on the bracket, and while feeding the cable through the RPA, slide the RPA onto the bracket until it clicks.

Figure 2.7 shows the Trimble R7 receiver pole-mounted setup.

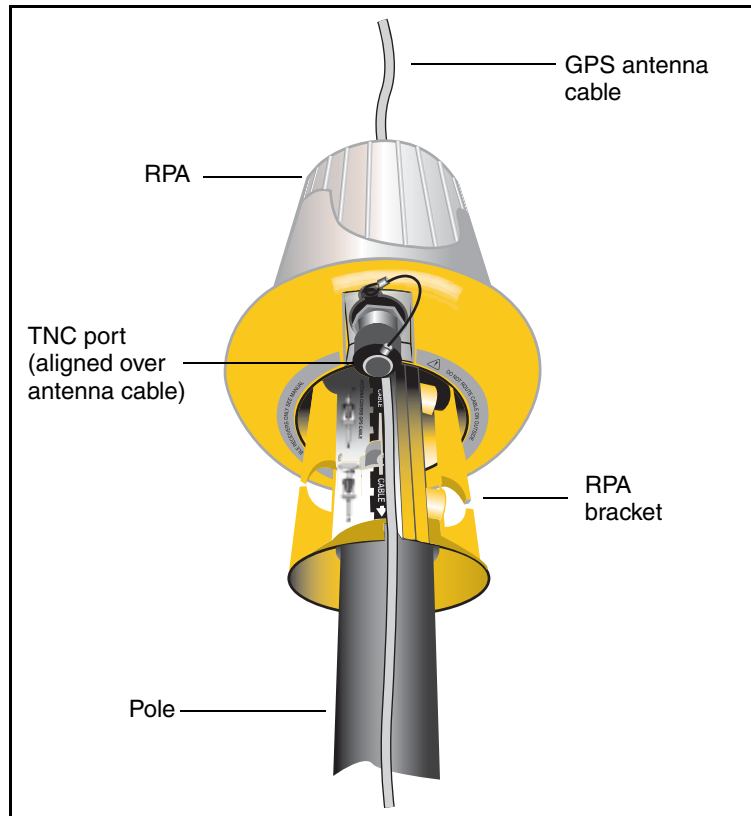

Figure 3.7 RPA and bracket

4. Mount the Zephyr antenna on the range pole.
5. Connect the GPS antenna cable. Make sure that the GPS cable is not hanging over the top of the RPA.
6. Connect the blue TNC-to-TNC radio cable to the RPA.

Mounting the Trimble R7 receiver

To mount the receiver on the pole:

1. Attach the receiver bracket to the pole:
 - a. Place the bracket against the pole, approximately 0.5 m from the ground.

Note – If you are using a 1" diameter pole, flip the black insert around inside the bracket, as shown in Figure 3.8.

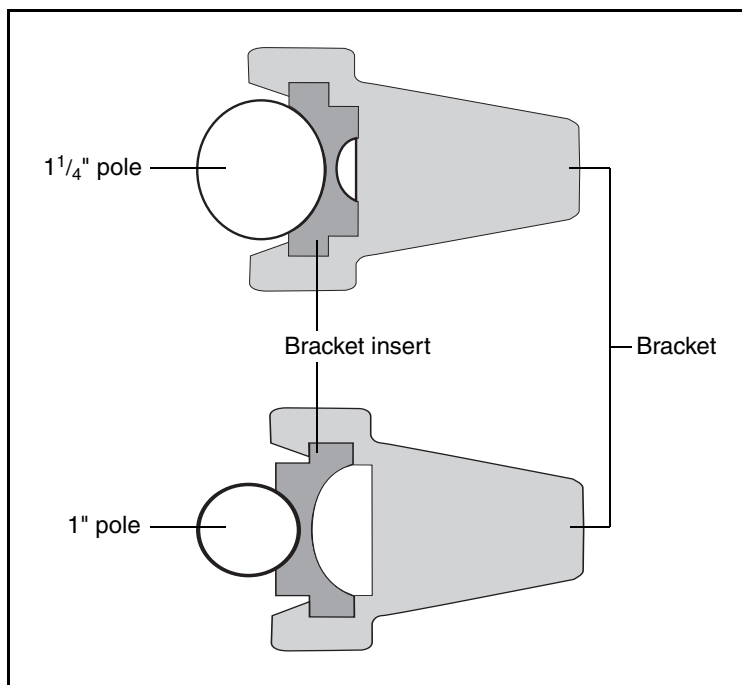

Figure 3.8 Receiver bracket insert

- b. Close the gates of the bracket around the pole.
 - c. Seat the base of the clip lock in the opposite gate.

- d. Lock the clip lock.
If the clip lock is too tight to be locked, turn it one or two turns counterclockwise and try again. If it is too loose, turn it one or two turns clockwise and try to lock it again.
2. Mount the receiver on the bracket:
 - a. Pull the bracket side locks in towards the pole.
 - b. Set the receiver catch lock in the bracket.
 - c. Holding the receiver in the bracket, pull the side locks back to their original positions, as shown in Figure 3.9.

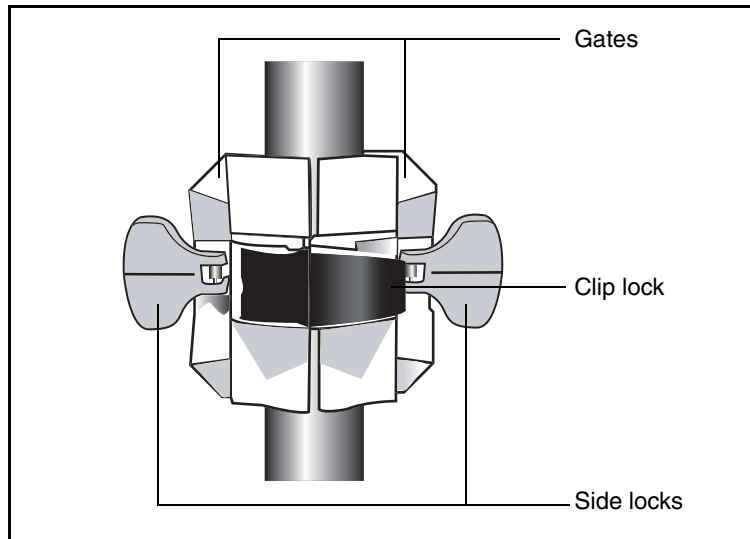

Figure 3.9 Trimble R7 receiver bracket

3. Connect the blue TNC radio communications cable to the blue TNC port on the receiver. If necessary, adjust the position of the receiver to remove cable slack.
4. Connect the yellow TNC GPS antenna cable to the yellow TNC port on the receiver. If necessary, adjust the position of the receiver to remove cable slack.

Mounting the TSC1/TSCe controller

To mount the TSC1™/TSCe™ controller on the pole:

1. Mount the controller bracket on the pole:
 - a. Place the bracket against the pole at a comfortable height.
 - b. Rotate the clamping screw on the bracket pole until tight.
 - c. Place the controller into the cradle assembly and tighten the clamping mechanism.
 - d. Any cables running down the pole should be run through the machined groove on the inside of the controller bracket.
 - e. Position the controller in the preferred position for operation by pressing the spring-loaded release button on the cradle, pulling the assembly outward, and rotating the cradle assembly to the desired angle. Reseat the cradle in the proper position by lining up the alignment pins and pushing inward until the release button locks.
2. Connect one end of the 2 ft 0-shell to 0-shell Lemo cable to the TSC1/TSCe controller.
3. Connect the other end of the Lemo cable to Port 1 on the receiver.
4. Place the hand grip below the controller bracket (or above it, depending on the position of the bracket), with the cables running through the grip.
5. Secure any loose cables, using the velcro cable ties.

Figure 2.10 shows the pole-mounted setup.

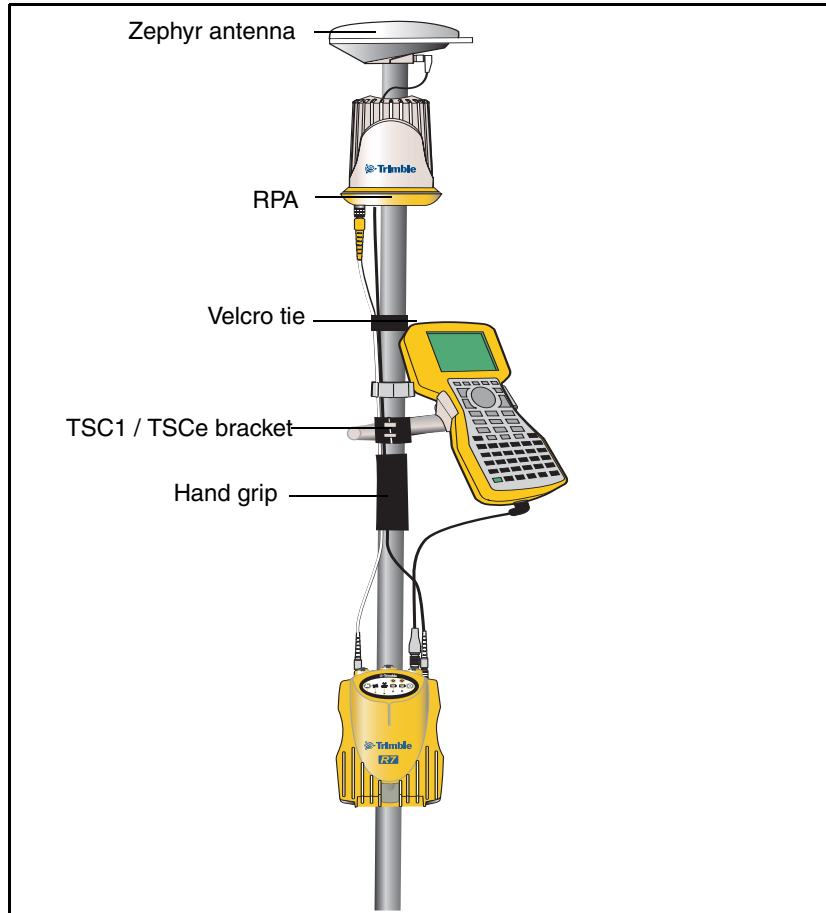

Figure 3.10 Pole-mounted setup

Backpack Setup

Both the whip and RPA antennae are suitable for use in a backpack. The RPA is installed in the same manner as for the pole-mounted setup (see Pole-Mounted Setup, page 22).



Tip – The RPA is tuned for operation with the GPS antenna cable running through it. Operating it from a backpack may reduce its operating range. Trimble recommends that you use the whip antenna.

To set up the Trimble R7 for use in a backpack:

1. Insert the receiver into the backpack with the ports on the top panel facing upwards and the front panel facing outwards. Secure the receiver around the middle with the velcro strap.
2. Attach the Zephyr™ antenna to a range pole.
3. Attach the whip antenna mount to one of the fittings on the top of the backpack.
4. The backpack has a feedthrough on both sides at the top and on both sides near the bottom to allow cables to be positioned out of the way of the main zipper. Run the radio communications cable through at the top, and connect it to the blue TNC port on the receiver.
5. Connect the straight end of the yellow GPS cable to the yellow TNC port on the receiver.
6. Run the right-angle connector on the yellow GPS cable through the top or side slot on the backpack, and connect it to the Zephyr antenna.
7. Connect one end of the 6 ft 0-shell to 0-shell cable to Port 1 on the receiver.
8. Run the 0-shell cable through the side slot of the backpack and connect it to the TSC1/TSCe controller.

Figure 3.11 shows the backpack setup.

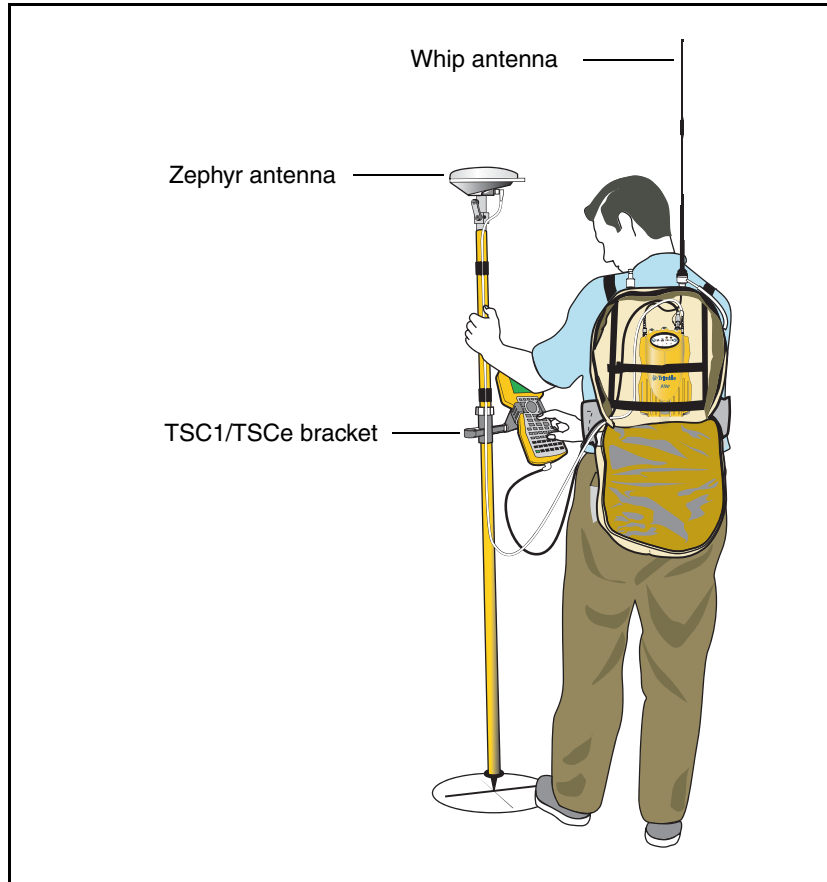

Figure 3.11 Backpack setup

Other System Components

This section describes optional components that you can use with the Trimble R7 receiver.

Radios

Radios are the most common data link for Real-Time Kinematic (RTK) surveying. The Trimble R7 receiver is available with an optional internal radio in either the 450 or 900 MHz UHF bands. You can also connect an external radio to Port 3, whether the internal radio is installed or not.

The Trimble R7 supports the following Trimble base radios when using the internal receiver radio:

- TRIMMARK™ 3
- TRIMMARK IIe
- TRIMTALK™ 450S
- SiteNet™ 450
- SiteNet 900
- Trimble R8 internal transmitter (base)

Internal Radio Setup

You can configure the Trimble R7 optional internal radio using any of the following:

- the GPS Configurator software
- the WinFlash software
- the Trimble Survey Controller software

For more information, refer to the GPS Configurator Help, the WinFlash Help, or the *Trimble Survey Controller User Guide*.

By default, the internal UHF radio has only a few frequencies installed. Use WinFlash to configure additional frequencies. For more information, see Adding frequencies for the 450 MHz internal radio, page 74.

External Radio Setup

To use an external radio with the Trimble R7 receiver, you need an external power source for the radio.

To set up a Trimble R7 using an external radio:

1. Connect one end of the yellow GPS antenna cable to the yellow TNC port on the receiver.
2. Connect the other end of the GPS antenna cable to a Zephyr or Zephyr Geodetic antenna.
3. Connect the external radio to Port 3 on the receiver.
4. Connect a radio antenna to the external radio.

3 Setting up the Receiver

Figure 3.12 shows a TRIMMARK 3 connected to a Trimble R7 receiver.

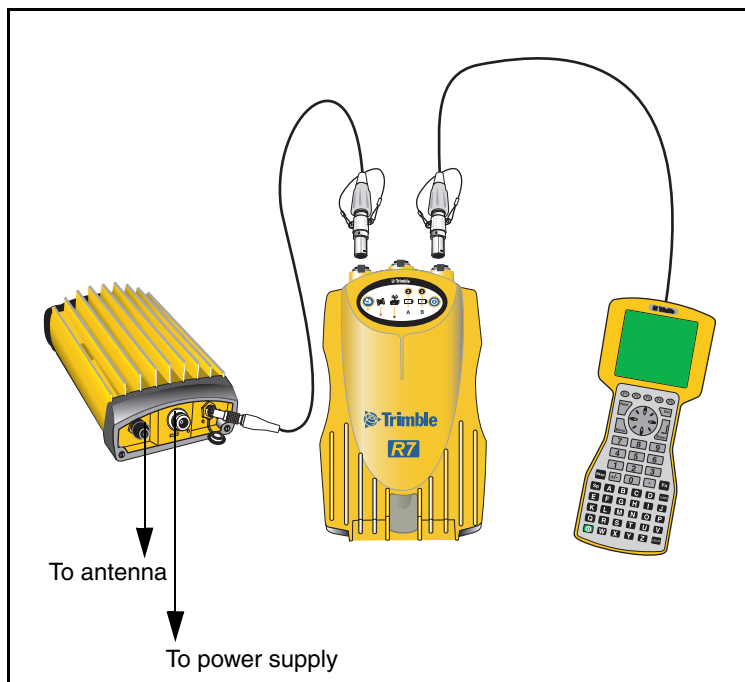

Figure 3.12 Connecting an external radio

5. Connect an external power source to Port 2 on the receiver.

Note – External rover radios must have their own power source because the internal Lithium-Ion batteries do not supply enough voltage. Alternatively, supply external power to port 2 of the receiver, and enable power out on port 3. Base radios must have their own power source because of their high power consumption.

Alternatively, you can apply external power directly to the radio, if it supports it.

You can use a 10 Ah battery, a 6 Ah battery, or camcorder batteries. The choice of power supply depends on the application, and whether you are using the radio as a reference or rover radio. For more information about the power capabilities of the Trimble R7, see *Batteries and Power*, page 45.

6. Configure the external radio using Trimble Survey Controller. Alternatively, you can configure a TRIMMARK 3 radio using WinFlash or the configuration software supplied with the radio.

For more information, refer to the *Trimble Survey Controller User Guide* or the appropriate Help.

7. Set up any other equipment as required, depending on whether you are using the radio as a reference or a rover radio.

Cellular modems

You can use a cellular modem instead of a radio as your data communications link. Cellular modems and other radio links can be used to extend the limits of your surveys.

To connect a cellular modem to a Trimble R7 receiver, you need the following:

- A Trimble R7 receiver
- A custom-designed cellular modem, or a cellphone that can transmit and receive data
- Serial (cellphone to DB9) cable (supplied with the cellular modem or phone)
- Trimble DB9 to 0-shell Lemo cable

***Note** – This cable is suitable only if flow control can be disabled on the cellular modem. If the cellular modem does not support this functionality, a special cable is required. For more*

3 Setting up the Receiver

information, refer to the document Using Cellular and CDPD Modems for RTK, which is available from your local Trimble Distributor.

Figure 3.13 shows the components required to connect a cellphone to a Trimble R7 receiver.

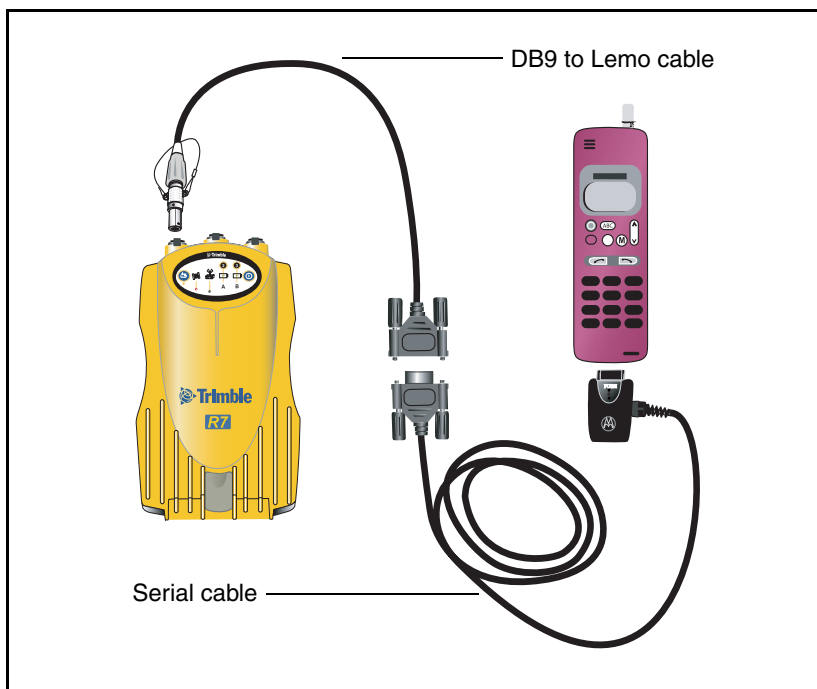

Figure 3.13 Connecting a cellphone

For more information on using a cellular modem as a data link, refer to the *Trimble Survey Controller User Guide*.

Antennas

The Trimble R7 receiver should normally be used with a Zephyr or Zephyr Geodetic antenna. These antennas have been designed specifically for use with the Trimble R7.

Use Figure 3.14 as a guide for measuring the height of the Zephyr and Zephyr Geodetic antennas. The Zephyr antenna is designed to be measured to the top of the notch. The Zephyr Geodetic (shown) has been designed to be measured to the bottom of the notch.

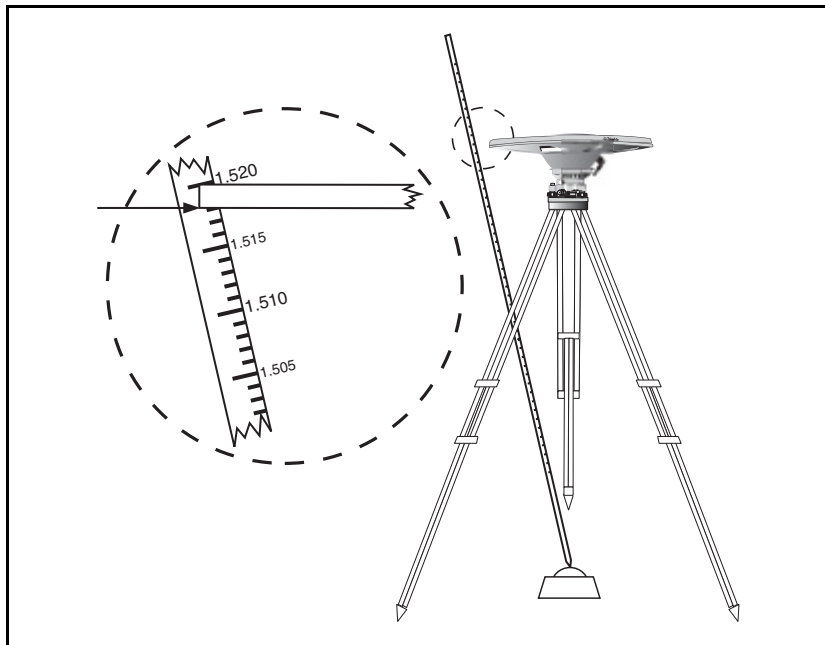

Figure 3.14 Measuring antenna height

Older models of antennas, such as the Choke Ring or Micro-Centered™ L1/L2 antennas, need more power to operate than the Zephyr models. To configure the receiver to output more power on the antenna port, select the correct antenna type in GPS Configurator, or through the Trimble controller. For information on how to do this, contact your local Trimble Service Provider.

CompactFlash cards

The Trimble R7 logs data internally on a CompactFlash card. However, it only support the Type I CompactFlash card. Trimble recommends that you use an industrial-rated CompactFlash card, as commercial cards have a limited operating temperature range.

Before logging data to a CompactFlash card, format the card to ensure the integrity of the file system. To format the card, insert it in the receiver and then hold down **[P]** for 30 seconds.

***Note** – Make sure that you format your CompactFlash card in the receiver. This prevents data on the card from being corrupted if the card is removed while data is being logged. Formatting the card in your PC may cause data corruption, or loss of data.*

When inserting the card, make sure that it slides into the card slot properly.



WARNING –

- The Trimble R7 allows for a maximum of 512 files on the CompactFlash card, regardless of the card's capacity. The file names must be in 8.3 format, otherwise files copied to the CompactFlash card may cause data corruption or loss of data when logging.
 - If the card does not seat into the pins correctly, do **not** use force or you may damage the pins. Remove the card and reinsert it carefully.
-

General Operation

In this chapter:

- Introduction
- Button Functions
- LED Behavior
- Starting and Stopping the Receiver
- Logging Data
- Resetting to Defaults
- Formatting a CompactFlash Card
- Batteries and Power

Introduction

All the controls that you need for general operation of the Trimble R7 receiver are located on the front panel, as shown in Figure 4.1.

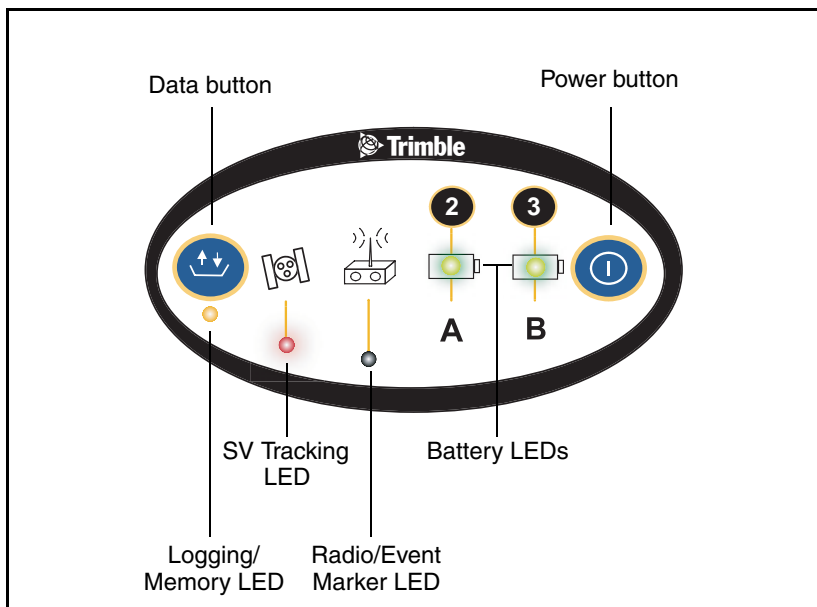

Figure 4.1 Controls on the front panel of the Trimble R7

For more information about other panels of the Trimble R7, see Parts of the Receiver, page 12.

Button Functions

The Trimble R7 has only two buttons: a Power button, represented in this manual by **[P]**, and a Data button, represented by **[D]**.

Use **[P]** to switch the receiver on or off, and to perform data management functions such as deleting files or resetting the receiver.

Use **(D)** to start or stop logging. This button is only effective when the receiver is switched on and has completed any power-up and initialization tasks.

Table 4.1 describes the main functions of the two buttons.

Table 4.1 Button functions

Action	Power button	Data button
Turn the receiver on	Press	
Turn the receiver off	Hold for 2 seconds	
Start logging data internally		Press
Stop logging data internally		Hold for 2 seconds
Delete the ephemeris file	Hold for 15 seconds	
Reset the receiver to factory defaults	Hold for 15 seconds	
Delete application files	Hold for 30 seconds	
Format the CompactFlash card	Hold for 30 seconds	

Note – The term “press” indicates that you should press the button and release it immediately. The term “hold” indicates that you should press the button and hold it down until the time indicated has elapsed.

LED Behavior

The five LEDs on the top panel of the receiver indicate various operating conditions. Generally, a lit or slowly flashing LED indicates normal operation, an LED that is flashing quickly indicates a condition that may require attention, and an unlit LED indicates that no operation is occurring. The following table defines each possible LED state.

The term ...	means that the LED ...
Flash	is lit briefly every 3 seconds
Slow flash	alternates slowly between being lit and unlit

4 General Operation

The term ...	means that the LED ...
Fast flash	alternates rapidly between being lit and unlit
On	is lit
Off	is unlit

Logging/Memory LED

The yellow Logging/Memory LED below the  button indicates the status of data logging and memory usage.

Behavior	Meaning
On	Data is being logged.
Slow flash	Enough FastStatic data has been logged. Alternatively, if the red SV Tracking LED is on solid at the same time, the receiver is in Monitor mode, and is checking for new firmware to install.
Fast flash	Data is being logged but memory is low.
Flash	The receiver is in Sleep mode, and will wake up five minutes before the scheduled start time of a timed application file.
Off	Data is not being logged, or the CompactFlash card is full.

SV Tracking LED

The red SV Tracking LED below the SV icon  indicates the status of satellite tracking.

Behavior	Meaning
Slow flash	Tracking four or more satellites.
Fast flash	Tracking three or fewer satellites.
Off	Not tracking any satellites.
On	The receiver is in Monitor mode, and is checking for new firmware to install.

Radio LED

The green Radio LED below the Radio icon  indicates the status of data input and output.

Behavior	Meaning
Slow flash	A data packet or event marker has been received.

Battery 1 LED and Battery 2 LED

The Battery LEDs inside the two Battery icons  indicate the status of the two internal batteries, or the power sources connected on Ports 2 and 3.

By default, each battery LED indicates the status of the external power source on the corresponding port. If no external source is detected, each LED indicates the status of an internal battery. The color of the LED indicates whether the power source is currently in use (green) or is on standby (yellow).

Color	Meaning	Behavior	Meaning
Green	Power source is in use	On	Healthy
		Fast flash	Low power
		Off	No power source is present
Yellow	Power source is on standby	On	Healthy
		Fast flash	Low power
		Flash	Dead
		Off	No power source is present

Starting and Stopping the Receiver

To turn on the receiver, press **[P]**.

To turn off the receiver, hold down **[P]** for two seconds.

Logging Data

You can log data to the CompactFlash card in the receiver, or to the survey device.

Logging internally

The Trimble R7 receiver logs GPS data internally on a CompactFlash card. You can then use the Trimble Data Transfer utility to transfer logged data files to your office computer. The transferred files are in Trimble DAT (.dat) format.



WARNING – The Trimble R7 allows for a maximum of 512 files on the CompactFlash card, regardless of the card's capacity. The file names must be in 8.3 format, otherwise files copied to the CompactFlash card may cause data corruption or loss of data when logging.

Data is logged using the current logging settings configured in the receiver. Data files logged internally are named automatically.

To begin internal logging, press **[D]**. The Logging/Memory LED lights up.

To stop logging, hold down **[D]** for at least two seconds. The Logging/Memory LED turns off.

Note – When the CompactFlash card is full, the receiver stops logging data, and the Logging/Memory LED switches off. Existing data files are not overwritten.

Approximate storage requirements for different logging rates are shown in Table 4.2. The values shown are for a one-hour logging session with six satellites visible.

Table 4.2 Storage requirements

Logging rate	Memory required
10 Hz	2,588 KB
1 Hz	335 KB

Table 4.2 Storage requirements (continued)

Logging rate	Memory required
5 seconds	87 KB
15 seconds	37 KB

Note – If power is lost, or the CompactFlash card is removed while logging, the file system is designed so that a maximum of ten seconds of data will be lost, regardless of the logging rate. To ensure that this behavior occurs, use GPS Configurator to perform a quick format of the CompactFlash card before logging data to the card for the first time.

Logging to a Trimble controller

When the Trimble R7 receiver is connected to a Trimble controller, you can log GPS data from the receiver to the controller, or to a PC card inserted in the controller. When you use a Trimble controller, you do not use the receiver's controls. Instead, you use the controller functions to set logging options, specify filenames, and control when logging occurs.

Data is stored in job files, which can be transferred to your office computer using Trimble's Data Transfer utility.

For more information on logging data from a receiver using a Trimble controller refer, to the user guide for your particular controller.

Resetting to Defaults

To reset the receiver to its factory default settings, hold down **[P]** for at least 15 seconds.



WARNING – Make sure that you do not hold down **[P]** for more than 30 seconds. After 30 seconds, any application files stored in the receiver are deleted and the CompactFlash card is reformatted.

Resetting the receiver to its factory defaults also deletes any ephemeris file in the receiver.

For more information, see Chapter 9, Default Settings.

Formatting a CompactFlash Card

To format a CompactFlash card for use in a Trimble R7 receiver, insert the card in the CompactFlash port, then hold down **[P]** for at least 30 seconds. After 15 seconds, the receiver is reset to its factory defaults, and any ephemeris file is deleted. After 30 seconds, any files stored on the card are deleted and the CompactFlash card is reformatted.



WARNING – Formatting a CompactFlash card while it is in the receiver deletes all the data files on the card and all the application files in the receiver.

***Note** – When you use **[P]** to format the CompactFlash card, a quick format is performed. A quick format reformats the card for use with the Trimble R7 receiver and deletes all data on the card. A full format checks the card for errors or bad sectors, and is only necessary if the card is corrupted. To perform a full format, use GPS Configurator. For more information, see GPS Configurator Software, page 70.*

Batteries and Power



WARNING – Do not damage the rechargeable Lithium-ion battery. A damaged battery can cause an explosion or fire, and can result in personal injury and/or property damage.

To prevent injury or damage:

- Do not use or charge the battery if it appears to be damaged. Signs of damage include, but are not limited to, discoloration, warping, and leaking battery fluid.
 - Do not expose the battery to fire, high temperature, or direct sunlight.
 - Do not immerse the battery in water.
 - Do not use or store the battery inside a vehicle during hot weather.
 - Do not drop or puncture the battery.
 - Do not open the battery or short-circuit its contacts.
-

The Trimble R7 can be powered either by its two internal batteries or by an external power source connected to Port 2 or Port 3. The charge provided by the internal batteries depends on the type of survey and operating conditions. Typically, one battery provides about 3.5 hours of power during an RTK survey using the internal radio, and about 5 hours during a survey without the internal radio.

The external power source is always used in preference to the internal batteries. When there is no external power source connected, or if the external power supply fails, the internal batteries are used. The internal batteries are drained in turn, and the receiver automatically switches to the full battery when the first battery is drained.

If no external power is supplied and both internal batteries are drained, none of the data that you have logged is lost. When internal or external power is restored, the receiver restarts in the same state as when power was lost. For example, if the receiver was logging data, the data file is not corrupted, and when power is restored the receiver resumes logging with the same settings as before.

4 General Operation

The power supply that is supplied with the Trimble R7 receiver charges the receiver internal batteries while they are still in the receiver. To do this, connect the power supply to the power/serial data cable, connect the cable to Port 2 on the receiver, and connect the power supply to an AC power source, as shown in Figure 4.2.

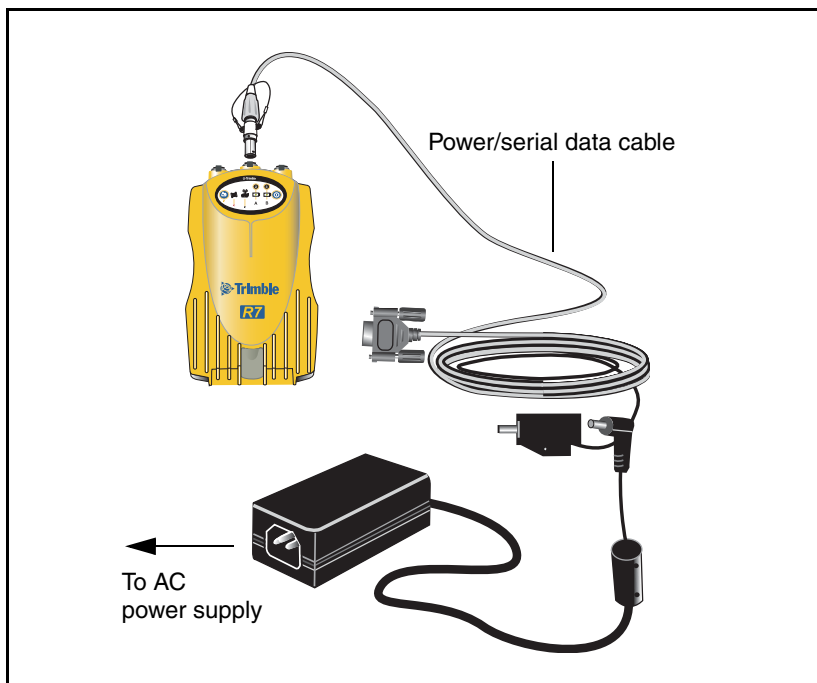

Figure 4.2 Charging the batteries

The two internal batteries take approximately eight hours to charge. They are charged individually, so each battery takes approximately four hours to charge. The internal batteries start charging whenever an external power supply of greater than 15 V is detected.



WARNING – Avoid contact with the rechargeable Lithium-ion battery if it appears to be leaking. Battery fluid is corrosive, and contact with it can result in personal injury and/or property damage.

To prevent injury or damage:

- If the battery leaks, avoid contact with the battery fluid.
 - If battery fluid gets into your eyes, immediately rinse your eyes with clean water and seek medical attention. Do not rub your eyes!
 - If battery fluid gets onto your skin or clothing, immediately use clean water to wash off the battery fluid.
-

Each receiver in your system is supplied with two internal Lithium-ion battery packs. To charge both sets of batteries, connect both receivers to power supplies as shown in Figure 3.2.

Battery charging and storage

All battery types discharge over time when they are not being used. Batteries also discharge faster in colder temperatures. If a Lithium-ion battery is to be stored for long periods of time, make sure it is fully charged before storing and re-charged at least every three months.



WARNING – Charge and use the rechargeable Lithium-ion battery only in strict accordance with the instructions. Charging or using the battery in unauthorized equipment can cause an explosion or fire, and can result in personal injury and/or equipment damage.

To prevent injury or damage:

- Do not charge or use the battery if it appears to be damaged or leaking.
 - Charge the Lithium-ion battery only in a Trimble product that is specified to charge it. Be sure to follow all instructions that are provided with the battery charger.
 - Discontinue charging a battery that gives off extreme heat or a burning odor.
 - Use the battery only in Trimble equipment that is specified to use it.
 - Use the battery only for its intended use and according to the instructions in the product documentation.
-

Charging the Lithium-ion battery

The rechargeable Lithium-ion battery is supplied partially charged. Charge the battery completely before using it for the first time. If the battery has been stored for longer than six months, charge it before use.

To protect the battery from deep discharge (5 volts or less), the Trimble R7 system is designed to switch batteries or cease drawing power when the battery pack discharges to 5.9 volts.

A battery that has reached the deep discharge level cannot be recharged and must be replaced. The following recommendations provide optimal performance and extend the life of your batteries:

- Fully charge all new batteries prior to use.
- Do not allow the batteries to discharge below 5 volts.
- Keep all batteries on continuous charge when not in use. Batteries may be kept on charge indefinitely without damage to the receiver or batteries.
- Do not store batteries in the receiver or external charger unless power is applied.
- If you must store the batteries, fully charge them before storing and then recharge them at least every three months.

Disposing of the rechargeable Lithium-ion battery

Discharge the Lithium-ion battery before disposing of it. When disposing of the battery, be sure to do so in an environmentally sensitive manner. Adhere to any local and national regulations concerning battery disposal or recycling.

Operating with the TSC1/TSCe controller

If the receiver is being powered by its internal batteries, it does not supply power to the TSC1/TSCe controller when they are connected. However, the TSC1/TSCe batteries and the Trimble R7 batteries can

be charged at the same time from the same power supply. To charge both sets of batteries, use two standard power/serial data cables to connect the TSC1/TSCe controller and the receiver to a power supply, as shown in Figure 4.3.

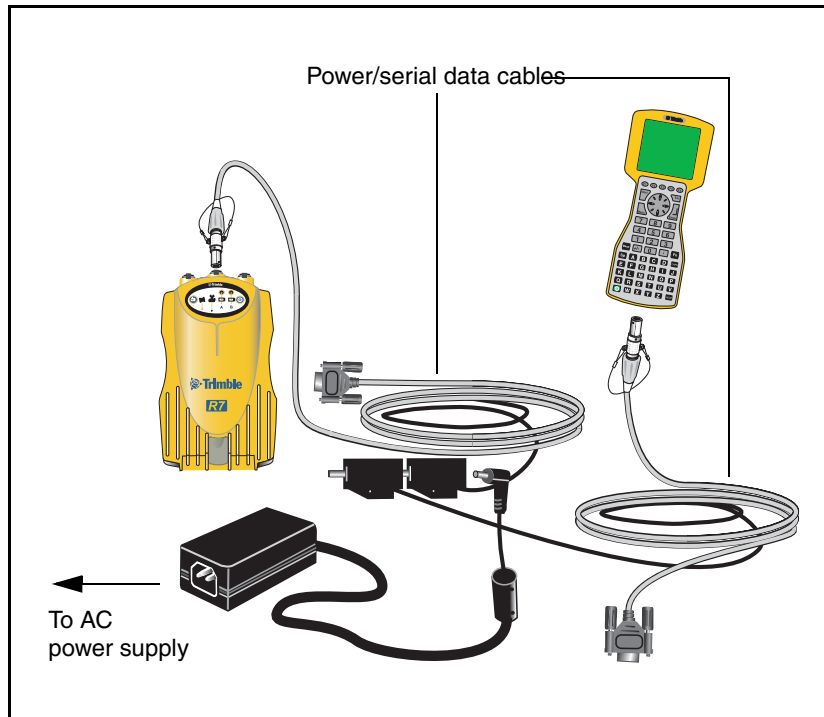

Figure 4.3 Charging receiver and TSC1/TSCe batteries

Power output

If the receiver is being supplied with power from an external source, power is automatically output on Port 1. The output voltage is approximately 0.5 V less than the input voltage. Port 1 outputs a maximum voltage of 20 V, even if the input voltage is higher.

You can use GPS Configurator or Trimble Survey Controller to enable power output on Port 3. Port 3 can be enabled for power output regardless of whether power is supplied internally or externally.

On Port 3, the output voltage is approximately 0.5 V less than the input voltage. For example, if power is being supplied from the internal Lithium ion batteries, the maximum battery voltage is 8.4 V, so the maximum output voltage is 7.9 V.

Note – When you start a survey using Trimble Survey Controller, and you are using an external radio, the software automatically enables power output on Port 3.

Firmware

A receiver's *firmware* is the program inside the receiver that makes the receiver run and controls the hardware. When you need to upgrade the firmware for your Trimble R7 receiver, Trimble recommends that you use WinFlash. For more information, see WinFlash Software, page 71.



WARNING – Upgrading the firmware deletes all application files on the Trimble R7 receiver.

An alternative method of upgrading your firmware is to copy the .elf file directly to the CompactFlash card from your computer.

To do this:

1. Connect the CompactFlash card to your desktop computer.
2. Using Windows Explorer, copy the .elf file from your computer to the CompactFlash card.
3. Disconnect the CompactFlash card from your computer and insert it into the receiver.
4. Turn the receiver off.
5. Hold down **[D]** and press **[P]**.

The receiver starts up in Monitor mode, automatically detects the newer version of the firmware, and installs it. In Monitor mode, the red SV Tracking LED is lit solidly and the yellow Logging/Memory LED flashes slowly.

The upgrade takes about two minutes. Once the upgrade procedure is complete, the receiver restarts automatically.

4 General Operation

Configuration

In this chapter:

- Introduction
- Configuring the Receiver in Real Time
- Configuring the Receiver Using Application Files
- Application Files

Introduction

The Trimble R7 receiver has no controls for changing settings. To configure the receiver, use external software, such as the GPS Configurator or Trimble Survey Controller software.

There are two ways to configure the Trimble R7:

- Configuring the receiver in real time
- Applying the settings in an application file

This chapter provides a brief overview of each of these methods, and describes the contents and use of application files.

Configuring the Receiver in Real Time

The GPS Configurator and Trimble Survey Controller software support real-time configuration of the Trimble R7 receiver.

When you configure the receiver in real time, you use one of these software applications to specify which settings you want to change. When you apply the changes, the receiver settings change immediately.

Any changes that you apply to the receiver are reflected in the Current application file, which is always present in the receiver. The Current application file always records the most recent configuration, so if you apply further changes (either in real time or using an application file) the Current file is updated and there is no record of the changes that you applied originally.

For more information on configuring the receiver in real time, see Chapter 7, Software Utilities.

Configuring the Receiver Using Application Files

An application file contains information for configuring a receiver. To configure a receiver using an application file, you need to create the application file, transfer it to the receiver, and then apply the file settings. GPS Configurator does this for you automatically when you work with configuration files.

For more information on applying application files, see Chapter 7, Software Utilities.

Application Files

An application file is organized into records. Each record stores configuration information for a particular area of receiver operation. Application files can include the following records:

- File Storage
- General Controls
- Serial Port Baud/Format
- Reference Position
- Logging Rate
- SV Enable/Disable
- Output Message
- Antenna
- Device Control
- Static/Kinematic
- Input Message
- Timed Activation

An application file does not have to contain all of these records. When you apply an application file, any option that is not included in the records in the file remains at its current setting. For example, if you

apply an application file that only specifies the elevation mask to use, all other settings remain as they were before the application file was applied.

You can store up to twenty different application files in battery-backed memory on the receiver. You can apply an application file's settings at the time it is transferred to the receiver, or at any time afterwards.

Special application files

The Trimble R7 has three special application files, which control important aspects of the receiver's configuration.

Default application file

The default application file (Default.cfg) contains the original receiver configuration, and cannot be changed. This file configures the receiver after it is reset. You can reset the receiver by holding down **(P)** for at least 15 seconds, or by using the reset option in GPS Configurator.

For more information on the default receiver settings, see Default Settings, page 85.

Although you cannot change or delete the default application file, you can use a power up application file to override any or all of the default settings.

Current application file

The current application file (Current.cfg) reflects the current receiver configuration. Whenever you change the receiver's configuration, either in real time or by applying an application file, the current file changes to match the new configuration.

You cannot delete the current file or change it directly, but every change to the receiver's current configuration is applied to the current file as well.

When you switch off the receiver then turn it on again, all the settings from the current application file are applied, so you do not lose any changes that you have made. The only exceptions are the following logging parameters:

- Logging rate
- Position rate
- Elevation mask

These parameters are always reset to the factory default values whenever the receiver is switched off.

Power Up application file

The power up application file (Power_up.cfg) is optional. If a power up file is present, its settings are applied whenever the receiver is powered up.

In this file, you can specify that the receiver is reset to defaults before the power up settings are applied. This ensures that restarting the receiver always results in the same configuration. This method is useful for defining “default” settings for the receiver that differ from those in the default file, which cannot be changed.

Alternatively, you can specify that the power up settings are applied immediately after the current application file’s settings have been applied. Restarting the receiver results in a configuration that uses your default settings for the options you define in the power up file, but the current settings for all other options.

By default, there is no POWER_UP application file on the receiver. To use a power up application file, you must create and save a POWER_UP application file in GPS Configurator. If you save this file to disk, the file is called Power_up.cfg. The extension .cfg is used by convention to identify application files on the office computer. When you transfer this file to the receiver, the file is saved on the receiver as POWER_UP, and becomes the new power up file.

The power up file is the only special application file that you can overwrite or delete from the receiver.

Timed application files

A timed application file contains a Timed Activation record which specifies when this file is to be applied. The main use of a timed application file is to automatically start or stop logging at a predefined time.

The Timed Activation record specifies:

- the UTC date and time when the application file is to be applied for the first time
- the interval at which the file is to be reapplied

If you do not specify a repeat interval, the settings are applied only once, at the specified time. If the file specifies a repeat interval, the file's settings are reapplied at the specified interval until the file is deactivated.

Note – If the receiver is logging continuously, the current logging takes precedence over any timed application file stored in the receiver.

Defining timed application files

To send timed application files to a Trimble R7, set up scheduled survey sessions in GPS Configurator. You can define multiple sessions, each specifying:

- basic logging parameters (data logging rate, position logging rate, and elevation mask)
- a starting time
- a duration

When you apply the current settings in GPS Configurator, each defined survey session is sent to the Trimble R7 as a pair of timed application files: the first includes the logging settings and start time, and the second contains settings that stop logging at the end time (which is calculated automatically from the duration you specify).

For more information on scheduled survey sessions, refer to the GPS Configurator Help.

The receiver can store up to 20 application files, so you can define a maximum of 10 scheduled survey sessions (10 pairs of start/stop timed application files).

Sleep mode

Whenever you press **(P)** to turn off the Trimble R7, it checks for a timed application file that is due to be activated in the future. If one exists, the receiver goes into Sleep mode instead of powering down.

In Sleep mode, the yellow Logging/Memory LED flashes every three seconds. The receiver wakes up five minutes before the scheduled activation time, so that it is ready to begin logging at the scheduled time.

Applying application files

An application file's settings do not affect the receiver's configuration until you **apply** the application file. You can do this at the same time that you save the file. Alternatively, save the file on the computer or in the receiver, then open it later and apply its settings.

Note – If the application file is a timed file, its settings do not take effect as soon as you apply the file, but at the time that the file specifies for its activation.

Storing application files

You can store application files that you create in GPS Configurator on the receiver and on the computer. For example, each file can represent a different user sharing the same receiver, or a particular mode of operation or survey style. Saving application files on your computer as well as in your receiver is optional, but it is useful because:

- it gives you a permanent copy of the settings you have sent to a receiver, for audit or your own reference.

- you can use the same file to configure multiple receivers identically.
- you can use an existing application file as a template for creating other application files with similar settings.

Naming application files

The application filename in the office computer and in the receiver is always the same. This makes it easier to recognize and keep track of your application files.

When you change the name of the application file in the receiver, this changes the application filename on your computer. When you transfer an application file from the receiver and save it to the computer, the system renames the file to match the internal receiver file. However, if you use Windows Explorer, for example, to change the .cfg filename on the computer, this **does not** change the internal receiver filename. This means that the GPS receiver does not recognize the change to the filename on the computer.

Transferring Data

In this chapter:

- Introduction
- Connecting to the Office Computer
- Transferring Data
- Transferring Files Directly from a Compactflash Card
- Deleting Files in the Receiver
- Supported File Types

Introduction

The Trimble R7 receiver keeps satellite measurements and other data in files stored on a CompactFlash card. These files cannot be processed until you transfer them to your office computer.

Note – The receiver supports a maximum of 512 files on the CompactFlash cards.

On returning to the office after completing a survey, transfer the field data to a computer that has the Trimble Geomatics Office™ software installed. You can then process the survey data in Trimble Geomatics Office to produce baselines and coordinates.

Connecting to the Office Computer

The Trimble R7 has three serial (COM) ports and one USB port for connection to the office computer. A USB connection is up to ten times faster than normal serial communications.

Use the standard power/serial data cable to connect the receiver to the computer, as shown in Figure 6.1.

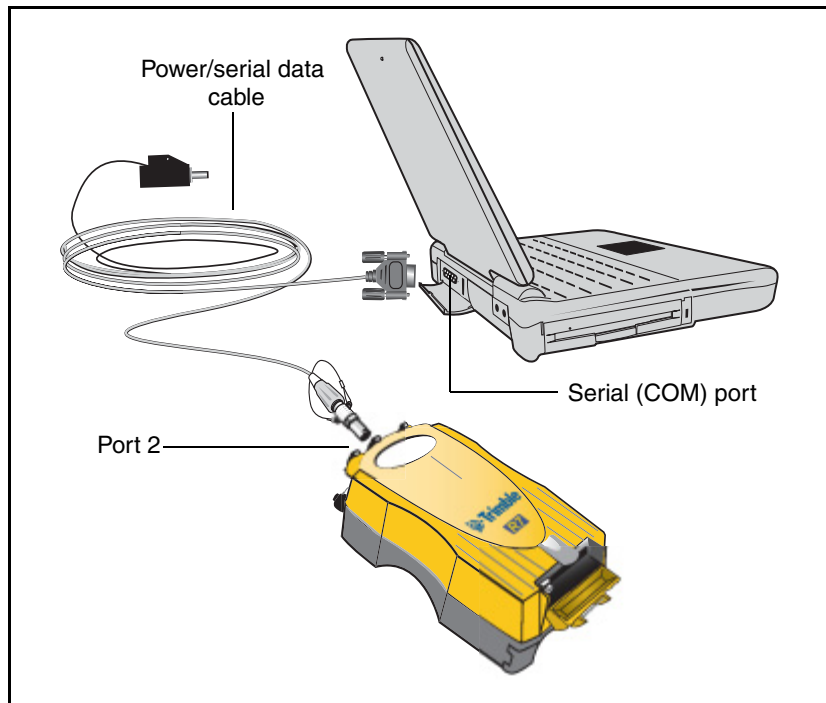

Figure 6.1 Connecting the Trimble R7 to a computer for serial data transfer

6 Transferring Data

Use the USB cable to connect the receiver to the computer, as shown in Figure 6.2.

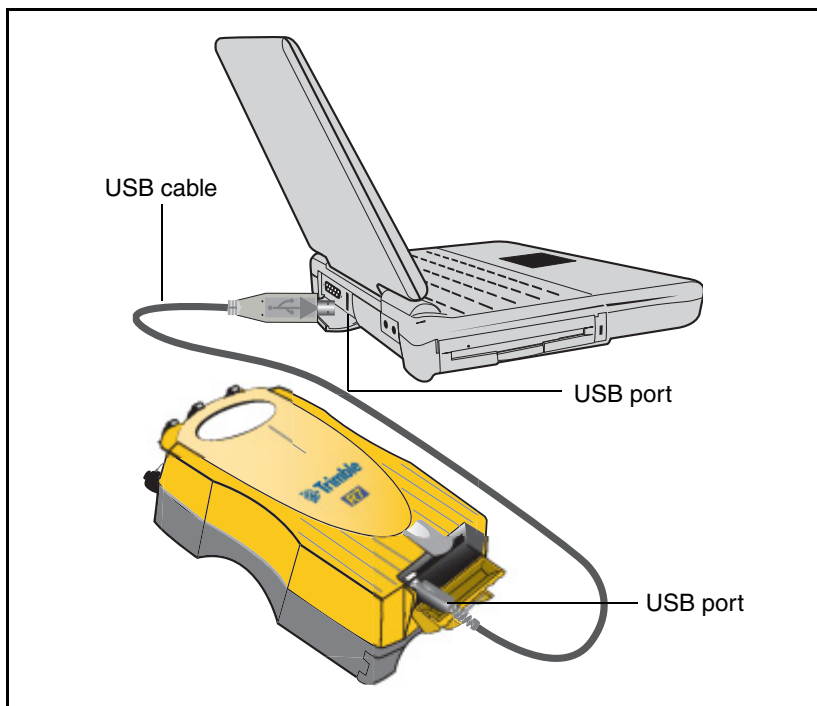

Figure 6.2 Connecting the Trimble R7 to a computer for USB data transfer

Note – When the receiver is connected to a USB port on a computer, it is treated as a peripheral device of the computer. If the receiver is unplugged or powered down, a warning message is displayed on the computer.

Transferring Data

Transfer the data files to the computer using the Trimble Data Transfer utility. You can run this utility as a standalone program or from within Trimble Geomatics Office. For more information about the transfer process, refer to the Data Transfer Help.

Note – When you connect to a receiver in the Data Transfer utility, you must use a GPS Receiver (R/5000 Series) device definition. If you use a GPS Receiver (4000 Series) device definition, the Data Transfer utility will be unable to establish communication with the receiver.

When transfer is complete, the Data Transfer utility automatically converts the file to the DAT format. If you are using Data Transfer from within Trimble Geomatics Office, the *Check-in* dialog appears. For more information, refer to the *Trimble Geomatics Office User Guide*.

Note – A file in DAT format is approximately six times the size of the corresponding file in the Trimble R7 internal format. Before transferring files, make sure that there is enough space on your computer.

Transferring Files Directly from a CompactFlash Card

All data is stored in a Trimble R7 receiver on an internal CompactFlash card. There are two ways to transfer files between the receiver and the office computer:

- Connect the receiver to the office computer and use the Data Transfer utility to transfer files.
- Remove the CompactFlash card from the receiver and connect it directly to your office computer, where it functions like a normal disk drive. Use Windows Explorer to transfer files.

When you use the Data Transfer utility to transfer data files from the CompactFlash card while it is still inserted in the receiver, the Data Transfer utility converts the raw receiver data (.T01) files you select into the Trimble DAT file format.

However, if you connect the CompactFlash card to your computer and then copy or move files to your computer, it treats the card like any other disk drive, and transfers the files without converting them. You need to convert these raw receiver files to DAT format files before you can use them on your office computer.

You can convert receiver data files by using a Windows Explorer extension which is installed on your computer when you install the Data Transfer utility.

***Note** – Although this extension is only available if you have the Data Transfer utility installed, you do not have to run the Data Transfer utility to use it.*

To convert a .T01 file on your office computer into the DAT format:

1. On your office computer, open Windows Explorer and navigate to the location of the .T01 file.
2. Right-click the file, and from the menu that appears select *Convert to DAT format*:

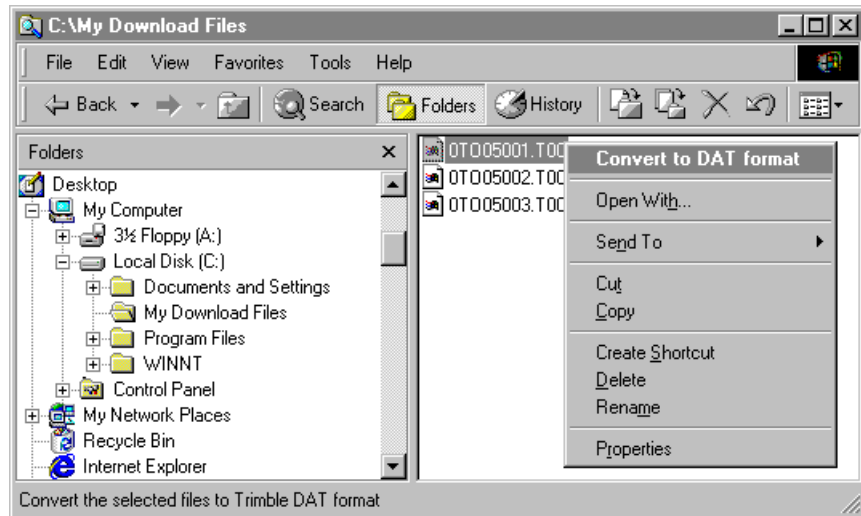

The *DAT File Conversion* dialog appears while the file is converted. When the dialog disappears, the file conversion is complete.

A new file with the same filename but a .dat extension appears in the same folder as the .T01 file.

Deleting Files in the Receiver

You can delete files stored in the receiver at any time. Do one of the following:

- Use the Data Transfer utility in Trimble Geomatics Office.
- Use the TSC1/TSCe controller.
- Hold down the power button (P) for 30 seconds after the receiver has been powered on. (When you use this method, *all* data is deleted, and the CompactFlash card is reformatted.)
- Use GPS Configurator.

Supported File Types

Table 6.1 shows the file types that you can transfer to or from a Trimble R7 receiver, and the software or utility that you must use to transfer each file type.

Table 6.1 Supported file types

File Type	Extensions	Transfer from Trimble R7?	Transfer to Trimble R7?	Software
Ephemeris	.eph	Yes	No	Data Transfer
Raw observations	.T01, .dat	Yes	No	Data Transfer
Receiver firmware files	.elf	No	Yes	WinFlash
Application files	.cfg	Yes	Yes	GPS Configurator

Note – The Trimble R7 receiver supports a maximum of 512 files on the CompactFlash card. Files stored on the compact flash must be 8.3 format. The Trimble R7 receiver does not support extended file names.

Software Utilities

In this chapter:

- Introduction
- GPS Configurator Software
- WinFlash Software

Introduction

This chapter provides information on the software utilities that you can use with the Trimble R7 receiver.

GPS Configurator Software

GPS Configurator is office software that configures selected Trimble GPS receivers.

GPS Configurator lets you:

- edit and save configuration files to the receiver and the computer
- check current receiver settings and operation
- change receiver settings in real time

Installing GPS Configurator

A copy of GPS Configurator is included on the *Trimble R7, Trimble R8, 5700, and 5800 GPS Receivers CD*.

To install the software:

1. Insert the disk into the CD drive on your office computer.
2. From the main menu select *Install individual software packages*.
3. Select *Install GPS Configurator vX.XX*.
4. Follow the on-screen instructions.

Configuring the Trimble R7 receiver

To configure a Trimble R7 receiver using GPS Configurator:

1. Connect Port 1 or 2 on the receiver to a serial (COM) port on the computer and apply power.
2. To start GPS Configurator, click  and then select *Programs / Trimble / GPS Configurator / GPS Configurator*.
3. Select *Trimble R7* in the *Device Type* dialog.

The software automatically establishes a connection with the receiver.

4. Make appropriate selections for your required receiver settings.
For more information, refer to the GPS Configurator Help.
5. Click **Apply**.

The settings in GPS Configurator are applied to the receiver.

WinFlash Software

WinFlash communicates with Trimble products to perform various functions including:

- installing software, firmware, and option upgrades
- running diagnostics (for example, retrieving configuration information)
- configuring radios

For more information, online help is also available when using WinFlash.

Note – WinFlash runs on Microsoft Windows 95, 98, NT, 2000, Me, or XP operating systems.

Installing WinFlash

WinFlash can be installed from the *Trimble R7, Trimble R8, 5700, and 5800 GPS Receivers CD*, or from the Trimble website.

Installing WinFlash from the CD

1. Insert the disk into the CD drive on your computer.
2. From the main menu select *Install individual software packages*.
3. Select *Install WinFlash vX.XX with Trimble R7 drivers and firmware*.
4. Follow the on-screen instructions.

Upgrading firmware

Your Trimble R7 receiver is supplied with the latest version of receiver firmware installed. If a later version becomes available, upgrade the firmware installed on your receiver.

WinFlash guides you through the firmware upgrade process. The steps required are described below. For more information, refer to the WinFlash Help.

To upgrade the Trimble R7 receiver firmware:

1. Start WinFlash.
The *Device Configuration* screen appears.
2. From the *Device type* list select Trimble R7 Receiver.
3. From the *PC serial port* field select the serial (COM) port on the computer that the receiver is connected to.
4. Click **Next**.

The *Operation Selection* screen appears. The *Operations* list shows all of the supported operations for the selected device. A description of the selected operation is shown in the *Description* field.

5. Select *GPS software upgrade* and click **Next**.

The *GPS Software Selection* window appears. This screen prompts you to select the software that you want to install on the Trimble R7 receiver.

6. Select the latest version from the *Available Software* list and click **Next**.

The *Settings Review* window appears. This screen prompts you to connect the receiver, suggests a connection method, and then lists the receiver configuration and selected operation.

7. If all is correct, click **Finish**.

Based on the selections shown above, the *Software Upgrade* window appears and shows the status of the operation (for example, Establishing communication with the Trimble R7. Please wait.).

8. Click **OK**.

The *Software Upgrade* window appears again and states that the operation was completed successfully.

9. Click **Menu** to select another operation, or click **Exit** to quit WinFlash.

10. If you click **Exit**, another screen appears asking you to confirm that you want to quit WinFlash. Click **OK**.

Adding frequencies for the 450 MHz internal radio

If your receiver has the optional internal radio installed, you can use WinFlash to add receiving frequencies to the default list.

To add radio receiving frequencies:

1. Start WinFlash.

The *Device Configuration* screen appears.

2. From the *Device type* list select Trimble R7 Receiver.
3. From the *PC serial port* field select the serial (COM) port on the computer that the receiver is connected to.
4. Click **Next**.

The *Operation Selection* screen appears. The *Operations* list shows all of the supported operations for the selected device. A description of the selected operation is shown in the *Description* field.

5. Select Configure Radio and click **Next**.

The *Frequency Selection* window appears:

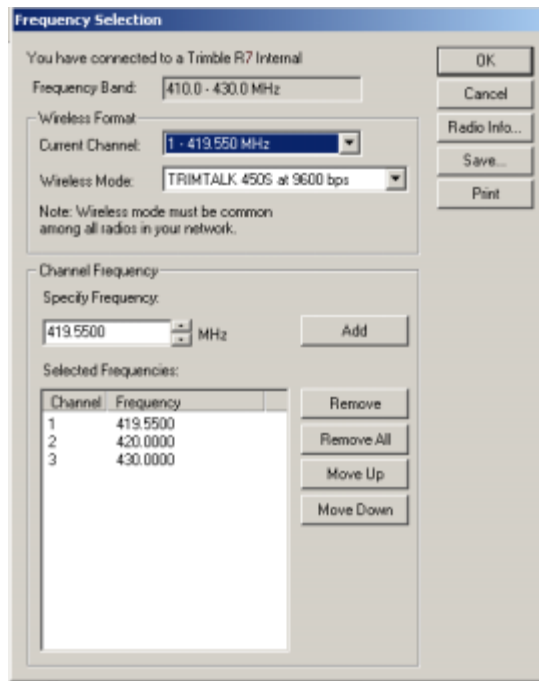

6. In the *Wireless Format* group, select the appropriate channel and wireless mode. The *Wireless Mode* must be the same for all radios in your network.
7. In the *Specify Frequency* field, enter the frequency you require.
8. Click **Add**. The new frequency appears in the *Selected Frequencies* list.

Note – The frequencies that you program must conform to the channel spacing and minimum tuning requirements for the radio. To view this information, click **Radio Info**. You may select either 12.5 or 25 kHz channel spacing. All radios in your network must use the same channel spacing.

9. When you have configured all the frequencies you require, click **OK**.

WinFlash updates the receiver radio frequencies and then restarts the receiver.

Configuring the internal 900 MHz radio setup

To configure the internal 900 MHz radio, use one of the following:

- Trimble Survey Controller running on a Trimble controller
- WinFlash (provided on the *Trimble R7, Trimble R8, 5700, and 5800 GPS Receivers CD*)

The internal radio has 40 selectable networks. You must choose the same network that is configured in the base radio you want to receive from.

Trimble Survey Controller

To configure the radio network using Trimble Survey Controller:

1. Connect the data/power cable to the controller and the receiver and turn on the controller. The receiver starts automatically.
2. From the main menu on the controller, select *Configuration*.
3. In the dialog that appears, select *Survey styles*, then from the *Type* field, select *RTK*.
4. Select *Rover radio*, then from the *Type* field select *Trimble Internal*.
5. Tap the **Connect** softkey.
6. Once connected, in the *Network number* field enter the number of the network set on your base radio.
Note – The Base Radio Mode field is not used here.
7. Tap the **Enter** softkey to complete configuration.

WinFlash

To configure the radio network using WinFlash:

1. Connect the data/power cable to Port 1 on the receiver.
2. Connect the female DE-9 connector on the other end of the data/power cable to a serial (COM) port on the computer.
3. Start WinFlash. The *Device Configuration* dialog appears.
4. From the *Device type* list, select *Trimble R7 Receiver*.
5. From the *PC serial port* field, select the serial port on the computer that the receiver is connected to and click **Next**.
6. From the *Operation selection* dialog, select *Configure radio* and click **Next**.
7. Confirm that your current settings are correct and click **Finish**. The *Configure 900MHz radio* dialog appears.
8. In the *Network number* field, select the same network that is set on your base radio.
9. In the *Country setting* field, select one of the following (according to how your base radio was shipped):
 - Your country (if available). This sets the radio to the a specific frequency range being transmitted by the base radio.
 - A single frequency. This limits the frequencies used to those authorized in your particular country.
10. Click **OK**.

WinFlash updates the radio settings and then restarts the receiver.

7 Software Utilities

78 Trimble R7/R8 GPS Receiver User Guide

Specifications

In this chapter:

- Introduction
- Physical Specifications
- Positioning Specifications
- Technical Specifications

Introduction

This chapter lists the specifications of the Trimble R7 receiver.

Physical Specifications

Table 8.1 lists physical specifications for the Trimble R7. The temperature rating of the receiver applies only when all doors on the receiver are closed.

Table 8.1 Physical specifications

Feature	Specification
Size	13.5 cm W x 8.5 cm H x 24 cm L (5.3 in. W x 3.4 in. H x 9.5 in. L)
Weight (with 2 batteries inserted)	1.4 kg (3.0 lb)
Battery life (at 20 °C)	RTK with internal radio: 3.5 hours No internal radio: 5 hours
Power input	11–28 V DC
Operating temperature	–40 °C to +65 °C (–40 °F to +149 °F) ^a
Storage temperature	–40 °C to +80 °C (–40 °F to +176 °F)
Humidity	100% condensing, unit fully sealed
Casing	Dust-proof, shock- and vibration-resistant

^aThe USB port only operates when the temperature is above 0 °C (32 °F). The internal batteries only charge when the temperature is in the range 0 °C to 40 °C (32 °F to 104 °F)

Positioning Specifications

Table 8.2 lists positioning specifications for the Trimble R7.

Table 8.2 Positioning specifications

Positioning	Mode	Horizontal Accuracy (RMS)	Vertical Accuracy (RMS)
RTK (OTF)	Synchronized	1 cm + 1 ppm (× baseline length)	2 cm + 1 ppm (× baseline length)
	Low Latency	2 cm + 2 ppm (× baseline length) ^a	3 cm + 2 ppm (× baseline length) ^a
L1 C/A Code Phase	Synchronized/ Low Latency	.25 m + 1 ppm RMS	.50 m + 1 ppm RMS
Static/ FastStatic	N/A	5 mm + 0.5 ppm (× baseline length)	5 mm + 1 ppm (× baseline length)
WAAS	N/A	Less than 5 m ^b	Less than 5 m ^b

^aDepends on radio link latency.

^b3D RMS values depend on WAAS system performance.

Technical Specifications

Table 8.3 lists technical specifications for the Trimble R7.

Table 8.3 Technical specifications

Feature	Specification
Tracking	24 Channels L1 C/A Code, L2C, L1/L2 Full Cycle Carrier, WAAS/EGNOS support Fully operational during P-code encryption WAAS satellite tracking
Signal processing	Maxwell V architecture Very low-noise C/A code processing Multipath suppression
Start-up	Cold start: < 60 seconds from power on Warm start: < 30 seconds with recent ephemeris
Initialization	Automatic while moving or static
Minimum initialization time	10 sec + 0.5 × baseline length (km)
Communications	Three RS-232 serial ports (Port 1, Port 2, and Port 3) Baud rates up to 115,200 bps RTS/CTS flow control negotiation supported on Port 3 only One USB port (download only)
Configuration	Via user-definable application files or GPS Configurator
Output formats	NMEA-0183: AVR; GGA; GSA; GST; GSV; PTNL,GGK; PTNL,GGK_SYNC; HDT; PTNL,PJK; PTNL,PJT; ROT PTNL,VGK; VHD; VTG; ZDA GSOF (Trimble Binary Streamed Output) 1PPS RT17

Default Settings

In this chapter:

- Introduction
- Default Settings
- Resetting to Factory Defaults
- Examples

Introduction

All Trimble R7 receiver settings are stored in application files. The Default application file, `Default.cfg`, is stored permanently in the receiver, and contains the factory default settings for the Trimble R7. Whenever the receiver is reset to its factory defaults, the current settings (stored in the Current application file, `Current.cfg`) are reset to the values in the Default application file.

You cannot modify the Default application file. However, if there is a Power Up application file (`Power_Up.cfg`) in the receiver, the settings in this file can be applied immediately after the Default application file, overriding the factory defaults.

For more information about application files, see [Application Files](#), page 55.

Default Settings

Table 9.1 shows the default settings for the Trimble R7 receiver, as defined in the default application file.

Table 9.1 Default settings

Function		Factory Default
SV Enable		All SVs enabled
General Controls:	Elevation mask	13°
	PDOP mask	7
	RTK positioning mode	Low Latency
	Motion	Kinematic
Power Output 3		Disabled
1PPS time tags		Off
ASCII time tags		Off
Serial Port 1:	Baud rate	38400
	Format	8-None-1
	Flow control	None
Serial Port 2:	Baud rate	38400
	Format	8-None-1
Serial Port 3:	Baud rate	38400
	Format	8-None-1
	Flow control	None
Input Setup:	Station	Any
NMEA/ASCII (all messages)		All Ports Off
Streamed output		All Types Off Offset = 00
RT17/Binary		All Ports Off
CMR output		[Static] CMR: cref ID 0000
RTCM output		RTCM: Type 1 ID 0000

Table 9.1 Default settings (continued)

Function		Factory Default
Reference position:	Latitude	0°
	Longitude	0°
	Altitude	0.00 m HAE
Antenna:	Type	Unknown external
	Height (true vertical)	0.00 m
	Group	All
	Measurement method	Bottom of antenna mount
Logging rate		15 sec
Position rate		5 min
Measurement rate		10 Hz

Resetting to Factory Defaults

To reset the receiver to its factory defaults, as defined above, do one of the following:

- Press and hold down (P) on the receiver for 15 seconds.
- In GPS Configurator, select *Connect to Receiver* and then click **Reset receiver** in the *General* tab.

Examples

The following examples show how the Trimble R7 uses the default settings and special application files in various situations.

Default behavior

The factory defaults specified above are applied whenever you start the receiver. If a Power Up file is present in the receiver, its settings are applied immediately after the default settings, so you can use a Power Up file to define your own set of defaults.

When you turn the receiver on and ...	then logging settings are ...	and logging ...
it is the first time that the receiver has been used	the factory defaults	does not begin automatically
you have reset the receiver to its factory defaults	the factory defaults, or those in the Power Up file ^a	does not begin automatically
you have performed a full reset	the factory defaults, because resetting deletes any Power Up file	does not begin automatically

^aA factory default setting is only used if the setting is not defined in the Power Up file.

Power up settings

When you turn the receiver off, any changes that you have made to logging settings are lost and these settings are returned to the factory defaults. Other settings remain as defined in the Current file. The next time you turn on the receiver, the receiver checks for a power up file and, if one is present, applies the settings in this file.

When you use (P) to turn the receiver off then on again and ...	then logging settings are ...	and all other settings are ...
you changed the receiver settings by applying an application file	the factory defaults	the last settings used
you changed the receiver settings using configuration software	the factory defaults	the last settings used
there is a Power Up application file in the receiver	the factory defaults, or those in the Power Up file ^a	the last settings used, or those in the Power Up file ^a

^aA factory default setting is used only if the setting is not defined in the Power Up file.

Logging after power loss

If the Trimble R7 loses power unexpectedly, when power is restored the receiver tries to return to the state it was in immediately before the power loss. The receiver does not reset itself to defaults or apply any Power Up settings. If the receiver was logging when power was lost unexpectedly, it resumes logging when power is restored.

However, when you switch the receiver off using (P), the receiver behaves as if you pressed (D) to stop logging before you pressed (P). In this case, when power is restored normally, logging does not begin until you start it manually.

When the receiver is logging data and then loses power ...	then when power is restored, data logging ...	and logging settings are ...	and all other settings are ...
unexpectedly	resumes automatically	the last settings used	the last settings used
when you press (P)	does not resume	the factory defaults	the last settings used

Disabling logging

You can disable logging by setting the receiver's data logging and position logging rates to Off. However, if you press (D) while logging is disabled, the receiver will still log data, using the default logging settings.

When you have disabled logging ...	then if you press (D) to start logging, logging settings are ...
using the Trimble Survey Controller or GPS Configurator software	the factory defaults
in the Power Up application file	the factory defaults

Application files

You can use application files to change the settings in the receiver. Sending an application file to the receiver does not necessarily apply the file's settings; you can apply a file's settings at any time after sending it to the receiver. You can also define timed application files. A timed application file contains receiver settings, but also includes a date and time when it is automatically activated.

If there is a timed application file on the Trimble R7, the receiver automatically applies the file's settings and begins logging (if logging settings are included in the file) at the specified time. If the receiver is in Sleep mode, it wakes up five minutes before the start time of the timed application file, and then begins logging, if required, at the specified start time.

When you send an application file to the receiver and ...	then the receiver settings are changed ...
you apply the file's settings immediately	as soon as you send the file to the receiver
you apply the file later	as soon as you apply the file
it is a timed application file	at the specified activation time

Cables and Connectors

In this chapter:

- Introduction
- Port 1, 2, and 3 Connectors
- Power/serial Data Cable
- Event/PPS Cable
- GPS Antennas and Cables

Introduction

This chapter provides pinout information for the Trimble R7 receiver standard and optional cables. This information can be used to build special cables for connecting the Trimble R7 to devices and instruments not supported by the standard and optional cables.

Port 1, 2, and 3 Connectors

Figure 10.1 shows the location of the Trimble R7 serial ports.

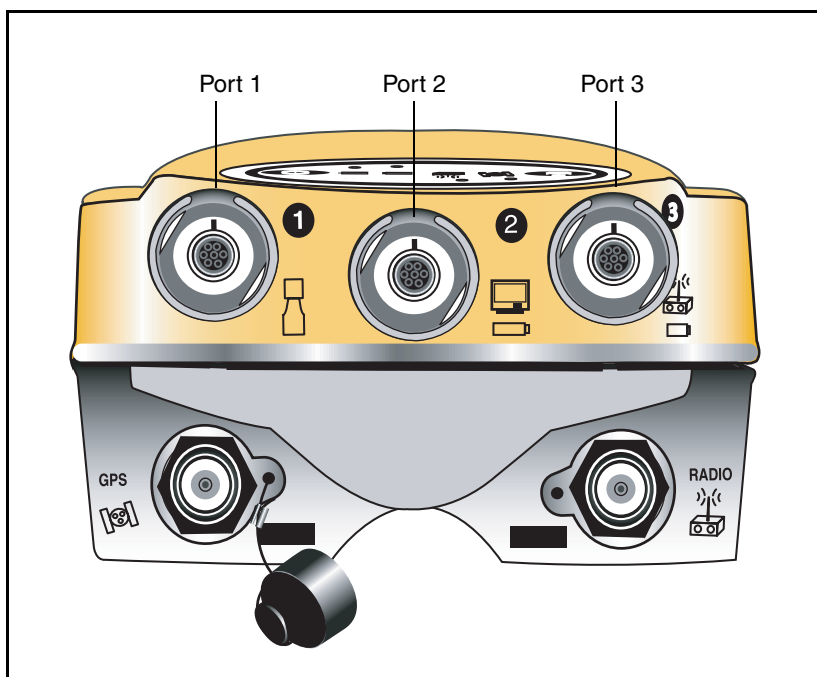

Figure 10.1 Trimble R7 serial ports

Figure 10.2 gives pinout requirements for the connector labeled Port 1. The pin locations for the Port 2 and Port 3 connectors are identical.

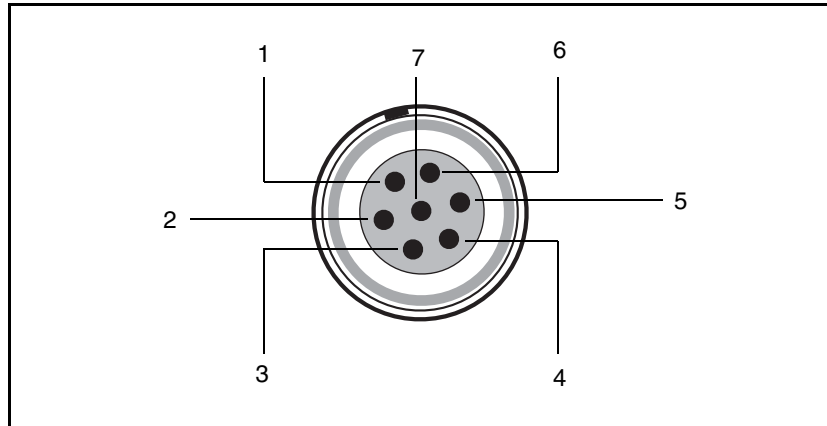

Figure 10.2 Pinout connectors

Table 10.1 describes the pinout functionality.

Table 10.1 Trimble R7 port pinouts

Pin	Pinout function		
	Port 1 (TSC1/TSCe controller, event, or computer)	Port 2 (Power in, computer, PPS, or event)	Port 3 (External radio or power in)
1	Signal GND	Signal GND	Signal GND
2	GND	GND	GND
3	TX data out (TXD1)	TX data out (TXD2)	TX data out (TXD3)
4	RTS1	1PPS	RTS3
5	CTS1/Event 2	Event 1	CTS3
6	Power Out (+)	Power In (+)	Power In/Out (+)
7	Serial data in (RXD1)	Serial data in (RXD2)	Serial data in (RXD3)

Power/serial data cable

Table 10.2 gives pinout information for the power/serial data cable (PN 32345), which is supplied with the Trimble R7.

Table 10.2 Power/serial data cable pinouts

Lemo 0-shell connector 7 Pin		Direction	DE9-F connector 7 Conductors			Power lead 2 Conductors	
Pin	Function		Pin	Color	Function	Color	Function
1	Signal ground	↔	5	Brown	Signal ground		
2	GND	→				Black	V-OUT
3	TXD	→	2	Orange	TXD		
4	RTS/TXD	→	8	Blue	RTS		
5	CTS/RXD	←	7	Green	CTS		
6	PWR	←				Red	Power IN (+)
7	RXD	←	3	Yellow	TXD		

Note – Table 10.2 assumes that the cable is attached to the connector labeled Port 1 or Port 3.

Event Marker/1PPS Cable

The event marker/1PPS cable shown in Figure 10.3 provides a breakout box with two BNC (female) connectors for providing 1PPS input and event marker output.

Connect a device that accepts 1PPS output pulses to the BNC connector labeled 1PPS on the breakout box. Connect a device that outputs event marker pulses to the Trimble R7, such as a photogrammetric camera, to the BNC connector labeled Event Marker on the breakout box.

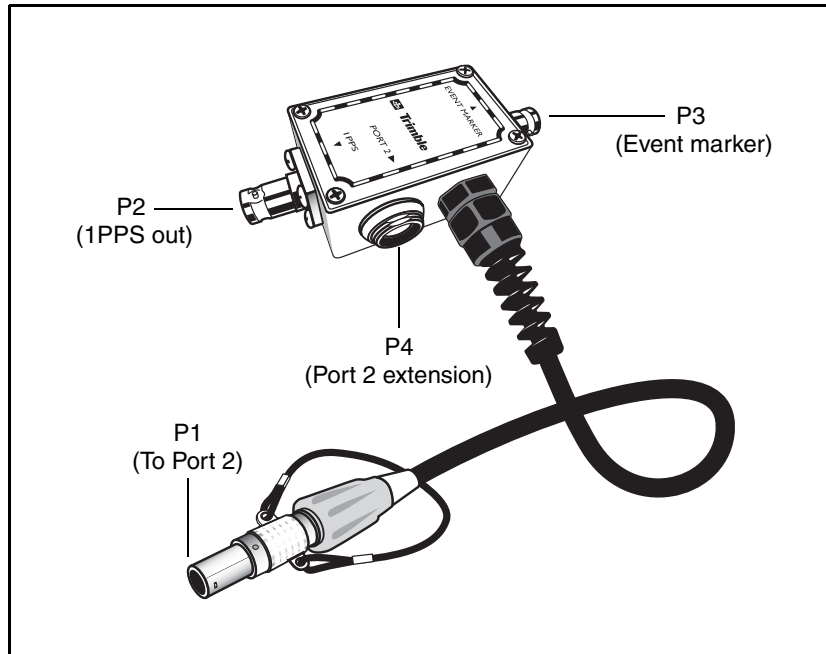

Figure 10.3 Event marker/1PPS cable

In addition, the breakout box includes a Lemo 7-pin connector to extend serial communications and/or power on Port 2. Because the BNC connectors are used to service the event marker and 1PPS features, pins 4 (1PPS) and 5 (Event Marker) are inactive on the Lemo connector.

For Port 2 pinouts, see Port 1, 2, and 3 Connectors, page 92. For more information on 1PPS input and event marker output, see Chapter 11, Event Marker Input and 1PPS Output.

Table 10.3 gives pinout information for the event marker/1PPS cable which is supplied with the Trimble R7. The event marker/1PPS cable is only used with the Trimble R7 connectors labeled Port 1 (for event marker output) and Port 2.

Table 10.3 Event marker/1PPS cable pinouts

P1: Lemo 7-Pin Port 2 Trimble R7		Direction	P2: BNC-F connector (1PPS)	P3: BNC-F connector (Event marker)	P4: Lemo 7s Port 2 extension	
Pin	Trimble R7 function		Pin	Pin	Pin	Function
1	Signal ground	←			1	Signal ground
2	GND	→	GND	GND	2	GND
3	Serial data out (TXD2)	←			3	Serial data in (TXD2)
4	1PPS	←	Center pin		4	No Connect
5	Event Marker	↔		Center pin	5	No Connect
6	Power IN (+)	→			6	Power IN (+)
7	Serial data in (RXD2)	←			7	Serial data out (RXD2)

GPS Antennas and Cables

The antenna that a receiver uses to collect satellite signals is sometimes called a GPS antenna to distinguish it from a radio antenna. Radio antennas are used for communication between receivers and external networks or systems.

Note – Older models of antennas, such as Choke Ring or Micro-Centered L1/L2, have different power requirements. The Trimble R7 can adjust the antenna power output when you designate the appropriate antenna in GPS Configurator. For more information, see Antennas, page 35.

Connect the receiver to its GPS antenna using the yellow TNC connector. Use a coaxial cable with a right-angle TNC plug at the antenna end.

If the antenna cable length is ...	use ...
up to 15 meters (45 feet)	RG-58 cable
up to 30 meters (100 feet)	RG-214 cable
over 30 meters (100 feet)	one of the following: <ul style="list-style-type: none"> • in-line amplifier • semi-rigid coaxial cable • a low-loss cable assembly

10 Cables and Connectors

Event Marker Input and 1PPS Output

In this chapter:

- Introduction
- Event Marker Input
- 1PPS Output

Introduction

The Trimble R7 receiver can accept event marker input on Port 1 and Port 2, and can generate 1PPS output on Port 2.

Event Marker Input

Event marker input is used to log a precise GPS time tag whenever an externally generated pulse, such as one generated at the time of the shutter closing from a photogrammetric camera, is received.

The event is triggered when the source pulse voltage transitions between 1.0 V DC and 2.0 V DC in less than 100 nsec. Trimble recommends that you use TTL level inputs. You can configure the receiver to recognize either a positive (rising) or negative (falling) voltage as the leading edge of a pulse. The accuracy of the associated time tag recorded for an event is determined by the GPS accuracy (typically less than 1 μ sec.).

The Trimble R7 records each event in the current data file. This record includes the port on which the event was received.

Enabling and configuring event marker input

To enable or configure the event marker input function, you need the GPS Configurator software.

In real time

You can use GPS Configurator to configure a Trimble GPS receiver connected to your office computer. For more information, see GPS Configurator Software, page 70, or refer to the GPS Configurator Help.

To enable event marker input:

1. Connect the computer to the Trimble R7 receiver.
2. Press  to turn on the receiver.

3. To start GPS Configurator, click  **Start**, then select *Programs / Trimble / GPS Configurator / GPS Configurator*.
The *GPS Configurator* dialog appears and the software automatically connects to the Trimble R7 receiver.
4. In the *General* tab, select the *Event marker* check box.
5. Select the appropriate option, Positive slope or Negative slope, depending on the type of pulse the external device uses.
6. Click **Apply**.
GPS Configurator sends the new configuration information to the receiver, and the receiver starts to accept event marker input.
7. Click **OK** to exit GPS Configurator.
The software disconnects from the receiver.

1PPS Output

The Trimble R7 receiver can output a one pulse per second (1PPS) time strobe with an associated ASCII time tag output. The pulse is output through Port 2 of the receiver using the event marker/1PPS cable.

1PPS pulse definition

The leading edge of the pulse coincides with the beginning of each UTC second, as shown in Figure 11.1. The pulse is driven by an RS-422 driver between nominal levels of 0 V and 4 V. The leading edge is positive, rising from 0 V to 4 V.

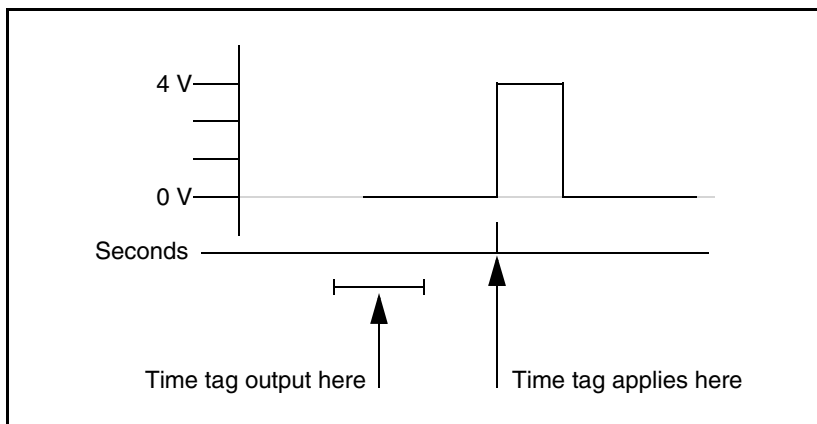

Figure 11.1 Time tag relation to 1PPS wave form

The pulse is approximately 8 μ sec wide, with rise and fall times of about 100 nsec. Resolution is approximately 40 nsec, but several external factors limit accuracy to approximately ± 1 μ sec:

- Position errors, especially with user-entered reference. Each meter of error can result in 3 nsec of error in the 1PPS pulse.
- Antenna cable length. Each meter of cable adds a delay of about 2 nsec to satellite signals, and a corresponding delay in the 1PPS pulse.

ASCII time tag definition

Each time tag is output about 0.5 second before the corresponding pulse, as shown in Figure 11.1. Time tags are in ASCII format on a user-selected serial port. The format of a time tag is:

UTC yy.mm.dd hh:mm:ss ab

Where:

- *UTC* is fixed text.
- *yy.mm.dd* is the year, month, and date.
- *hh:mm:ss* is the hour (on a 24-hour clock), minute, and second. The time is in UTC, not GPS time.
- *a* is the position-fix type:
 - 1 = 2D Position Fix for E,N only
 - 2 = 3D Position Fix
 - 3 = Single SV Clock-only fix
 - 4 = Automatic Mode
 - 5 = Reference Station Position
 - 6 = Two-Dimensional with Fixed Clock
 - 7 = Overdetermined solution for Clock-only
- *b* is the number of satellites being tracked: 1 to 9, “:” (for 10), “;” (for 11), or “<” (for 12).
- Each time tag is terminated by a *carriage return, line feed* sequence.

A typical printout looks like this:

UTC 93.12.21 20:21:16 56

UTC 93.12.21 20:21:17 56

UTC 93.12.21 20:21:18 56

If *a* and *b* are ??, the time is based on the receiver clock because the receiver is not tracking satellites. The receiver clock is less accurate than time readings extracted from satellite signals.

Enabling and configuring 1PPS output

To enable or configure the 1PPS output function, you need the GPS Configurator software.

In real time

You can use GPS Configurator to configure a Trimble GPS receiver connected to your office computer. For more information, see GPS Configurator Software, page 70, or refer to the GPS Configurator Help.

To enable 1PPS output:

1. Connect the computer to the Trimble R7 receiver.
2. Turn on the receiver.
3. To start GPS Configurator, click  **Start**, then select *Programs / Trimble / GPS Configurator / GPS Configurator*.

The *GPS Configurator* dialog appears and the software automatically connects to the receiver.

4. Select the *Serial outputs* tab.
5. Select the *1PPS (port 2 only)* check box.
6. If you want ASCII time tags enabled, select the check box and choose an output port.

7. Click **Apply**.

GPS Configurator sends the new configuration information to the receiver, and the receiver starts to generate 1PPS output on Port 2.

8. Click **OK** to exit GPS Configurator.

The software disconnects from the receiver.

11 Event Marker Input and 1PPS Output

SECTION

II

TRIMBLE R8 GPS RECEIVER

Overview

In this chapter:

- Introduction
- Features
- Use and Care
- COCOM Limits

Introduction

This chapter introduces the Trimble R8 GPS receiver. This receiver is designed for GPS surveying applications. The receiver incorporates a GPS antenna, receiver, internal radio with a transmit option or an internal GSM module, and battery in a rugged light-weight unit that is ideally suited as an all-on-the-pole RTK rover. Three LEDs allow you to monitor the satellite tracking, radio reception, data logging status, and power. Bluetooth® wireless technology provides cable-free communications between receiver and controller. The Trimble R8 receiver provides 24 total channels of L1/L2 satellite tracking, and supports logging of raw GPS observables to the handheld controller for post-processed applications.

The Trimble R8 is available as a standalone rover, base station, or as part of the GPS Total Station® system, offering maximum versatility in the system configuration to meet your specific requirements.

Features

The receiver provides the following features:

- Trimble R-track technology, which allows the receiver to track the L2 Civil signal (L2C)
- Centimeter-accuracy, real-time positioning with RTK/OTF data, up to 10 Hz position updates
- Submeter-accuracy, real-time positioning using pseudorange corrections
- Adaptive dual-frequency RTK engine
- WAAS/EGNOS capability
- Automatic OTF (on-the-fly) initialization while moving

- Single Lithium-ion rechargeable battery
- Cable-free Bluetooth communications with the Trimble Attachable Control Unit (ACU), or TSCe™ with Bluecap module
- Two RS-232 serial ports for:
 - NMEA output
 - RTCM SC-104 input and output
 - Trimble Format (CMR & CMR Plus) input and output
- One TNC radio antenna connector
- 6 MB internal memory for data storage
- Internal 450 MHz radio with a transmit option or GSM module

Use and Care

The Trimble R8 receiver is designed to withstand the rough treatment that typically occurs in the field. However, the receiver is a high-precision electronic instrument and should be treated with reasonable care.



WARNING – Operating or storing the Trimble R8 receiver outside the specified temperature range can damage it. For more information, see Chapter 17, Specifications.

High-power signals from a nearby radio or radar transmitter can overwhelm the receiver circuits. This does not harm the instrument, but it can prevent the receiver electronics from functioning correctly. Avoid using the receiver within 400 meters of powerful radar, television, or other transmitters. Low-power transmitters such as those used in cellphones and two-way radios normally do not interfere with receiver operations.

For more information, contact your local Trimble distributor.

COCOM Limits

The U.S. Department of Commerce requires that all exportable GPS products contain performance limitations so that they cannot be used in a manner that could threaten the security of the United States. The following limitations are implemented on the Trimble R8 receiver.

Immediate access to satellite measurements and navigation results is disabled when the receiver's velocity is computed to be greater than 1000 knots, or its altitude is computed to be above 18,000 meters. The receiver continuously resets until the COCOM situation is cleared.

Setting up the Receiver

In this chapter:

- Introduction
- Parts of the Receiver
- Setup Guidelines
- Pole-mounted Setup
- Other System Components

Introduction

This chapter provides general information on setup, connection, and cabling for the Trimble R8 receiver.

Parts of the Receiver

All operating controls on the Trimble R8 receiver are located on the front panel. Serial ports and connectors are located on the bottom of the unit.

Front panel

Figure 13.1 shows a front view of the Trimble R8 receiver. The front panel contains the three indicator LEDs, and the power button.



Figure 13.1 Trimble R8 receiver front panel

The power button controls the receiver's power on or off functions.

The indicator LEDs show the status of power, satellite tracking, and radio reception. For more information, see LED Behavior, page 125.

Lower housing

Figure 13.2 shows the lower housing of the Trimble R8 receiver. The lower housing contains the two serial ports, one TNC radio antenna or GSM antenna connector (depending on the internal communication module ordered), the removable battery compartment and the 5/8-11 threaded insert.

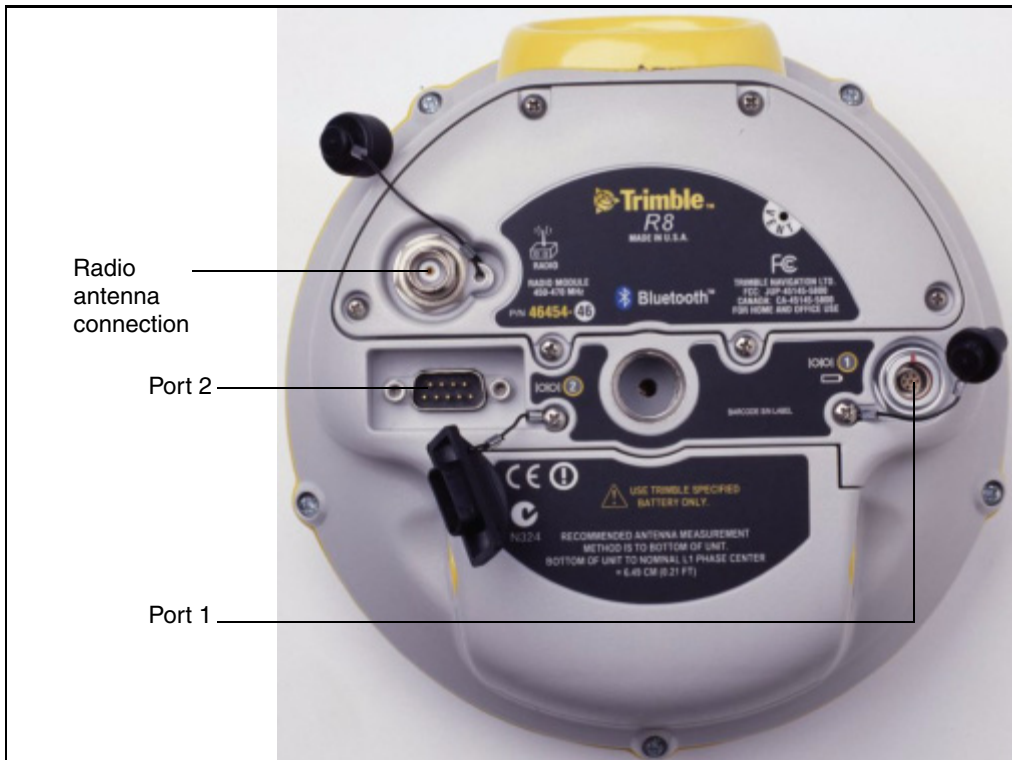





Figure 13.2 Trimble R8 lower housing

Each port or connector on the Trimble R8 receiver is marked with an icon to indicate its main function, as shown in Table 13.1.

Table 13.1 Trimble R8 receiver ports

Icon	Name	Connections
	Port 1	Device, computer, external radio, power in
	Port 2	Device, computer, external radio
	RADIO	Radio communications antenna

Port 1 is a 7-pin 0-shell LEMO connector that supports RS-232 comms and external power input. Port 1 has no power outputs.

Port 2 is a DB-9 male connector that allows for full 9-pin RS-232 comms. Port 2 does not support power in or out. For more information on default port settings, see Chapter 18, Default Settings. For more information on connector pinouts, see Chapter 19, Cables and Connectors.

The TNC connector is for connecting a radio antenna to the Trimble R8 internal radio. A whip “rubber duck” antenna is supplied with the system for units with internal UHF or 900 MHz radios. This connector is not used if you are using an external UHF radio or GSM.

External UHF or GSM antenna

Depending on which module you have purchased, use this TNC connection for an external antenna to enhance the UHF or GSM.

The UHF antenna is approximately 16.5 cm (6.5 inches) long, and round. The GSM antenna is approximately 16.5 cm (6.5 inches), and flatter than the UHF antenna. Make sure that you use the correct antenna or the signal will be degraded.

For more information on connecting the Trimble R8, see the following sections in this chapter.

Setup Guidelines

Consider the following guidelines when setting up the Trimble R8 receiver.



Caution – You must maintain a minimum separation distance of 20 cm (approximately 8 in.) between yourself and the radiating GSM antenna for this device to satisfy the RF Exposure requirements of the FCC. For mobile operation, the maximum gain of the GSM antenna must not exceed 0 dBi.

Environmental conditions

Although the Trimble R8 receiver has a waterproof housing, reasonable care should be taken to protect the unit. Avoid exposure to extreme environmental conditions, including:

- Water
- Heat greater than 65 °C (149 °F)
- Cold less than –40 °C (–40 °F)
- Corrosive fluids and gases

Sources of electrical interference

Avoid the following sources of electrical and magnetic noise:

- Gasoline engines (spark plugs)
- Televisions and PC monitors
- Alternators and generators
- Electric motors
- Equipment with DC-to-AC converters
- Fluorescent lights
- Switching power supplies

General guidelines

The following guidelines apply whenever you set up your receiver for operation:

- When plugging in a Lemo cable, make sure that the red dots on the receiver port and the cable connector line up. *Never* use force to plug cables in, as this may damage the connector pins.
- When disconnecting a Lemo cable, grasp the cable by the sliding collar or lanyard and pull the cable connector straight out of the port. Do not twist the connector or pull on the cable itself.
- To securely connect a TNC cable, align the cable connector with the receiver receptacle, then thread the cable connector onto the receptacle until it is snug.
- To insert the internal battery place the battery in the battery compartment, ensuring that the contact points are in the correct position to align with the contacts in the receiver. Slide the battery and compartment as a unit upward into the receiver until the battery compartment latches are locked into position.

Pole-Mounted Setup

Figure 13.3 shows the pole-mounted setup for the Trimble R8 receiver. To mount the receiver on a range pole:

1. Thread the unit onto the range pole.
2. Attach the controller bracket to the pole.
3. Insert the controller into the bracket.

4. If using the TSC1™, connect the data-i/o cable from Port 1 of the receiver to a port on the TSC1. If using the Trimble ACU, or TSCe with Bluecap module, no cabling is required, as shown in Figure 13.3.

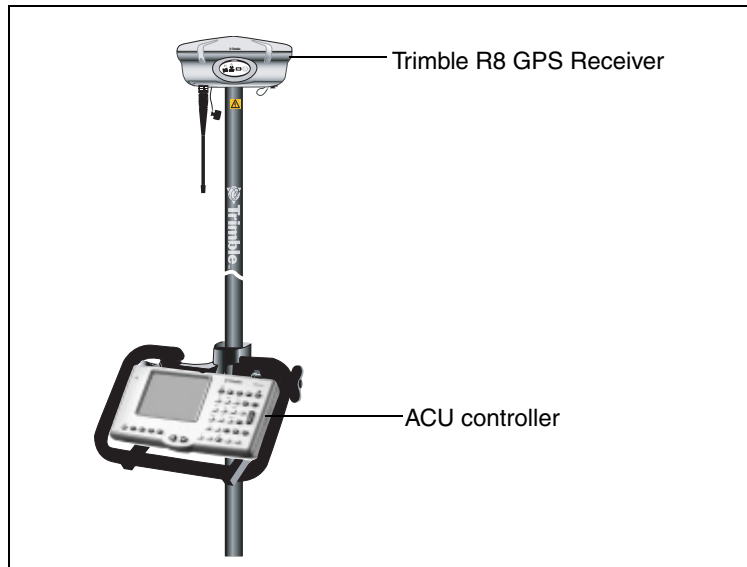

Figure 13.3 Trimble R8 receiver pole-mounted setup

Other System Components

This section describes optional components that you can use with the Trimble R8 receiver.

Radios

Radios are the most common data link for Real-Time Kinematic (RTK) surveying. The Trimble R8 is available with an optional internal radio in the 450 or 900 MHz UHF band, or with an internal GSM module. You can also connect an external radio to either port, whether the internal radio is installed or not.

The Trimble R8 receiver supports the following Trimble base radios with the internal 450 MHz or 900 MHz UHF radios:

- TRIMMARK™ 3
- TRIMMARK IIe
- TRIMTALK™ 450S
- SiteNet™ 450
- SiteNet 900
- Trimble R8 internal 450 transmitter

Internal GSM setup

You can configure the receiver optional internal GSM Module using the following software:

- Trimble Survey Controller

For more information, refer to the *Trimble Survey Controller User Guide*.

Internal radio setup

You can configure the receiver optional internal radio using any of the following software:

- GPS Configurator
- WinFlash
- Trimble Survey Controller™

For more information, refer to the GPS Configurator Help, the WinFlash Help, or the *Trimble Survey Controller User Guide*.

By default, the internal radio has only a few “test” frequencies installed at the factory. If you purchased the transmit option, the broadcast frequencies must be programmed at the factory. You can program the receive frequencies using WinFlash. For more information, see WinFlash Software, page 141.

Cellular modems and external radios

For a data communications link, you can use an internal or external radio, or an internal or external cellular modem.

To connect an external cellular modem to a Trimble R8 receiver, you need the following:

- A Trimble R8 receiver.
- A cellular modem, or a cellphone that can transmit and receive data.
- Serial (cellphone to DB9) cable (supplied with the cellular modem or phone).

Note – For more information, refer to the document [Using Cellular and CDPD Modems for RTK](#), which is available from the Trimble website.

- Port 2 of the Trimble R8 supports full RS-232 protocol, and should function properly with most cellular phone cables. Some cellular units may require custom cabling.

Alternatively, the Trimble R8 also supports a cable-free Bluetooth connection with Bluetooth enabled cell phones.

For more information on using an external cellular modem as a data link, refer to the *Trimble Survey Controller User Guide*.

To connect an external radio modem to a Trimble R8 receiver, you need the following:

- A Trimble R8 Receiver.
- An external radio capable of receiving and decoding Trimble data packets.
- Serial cable for either Port 1 or Port 2 of the Trimble R8, as supplied by the radio manufacturer.
- Radio mount for the range pole.

General Operation

In this chapter:

- Introduction
- Button Functions
- LED Behavior
- Starting and Stopping the Receiver
- Logging Data
- Resetting to Defaults
- Batteries and Power

Introduction

Figure 14.1 shows the Trimble R8 receiver front panel controls for the power on/off functions, or receiver reset. The LEDs provide power, radio, data logging, and SV tracking status information.

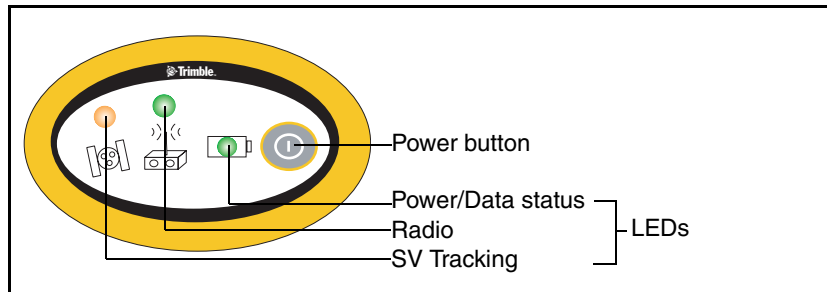

Figure 14.1 Controls and LEDs on front panel of the Trimble R8 receiver

Button Functions

The Trimble R8 receiver has only one button, the Power button, represented in this manual by **(P)**. Use **(P)** to switch the receiver on or off, and to perform other functions, as described in Table 14.1.

Table 14.1 Power button functions

Action	Power button
Turn the receiver on	Press
Turn the receiver off	Hold for 2 seconds
Delete the ephemeris file	Hold for 15 seconds
Reset the receiver to factory defaults	Hold for 15 seconds
Delete application files	Hold for 30 seconds

Note – The term “press” indicates that you should press the button and release it immediately. The term “hold” indicates that you should press the button and hold it down until the time indicated has elapsed.

LED Behavior

The three LEDs on the front panel of the receiver indicate various operating conditions. Generally, a lit or slowly flashing LED indicates normal operation, a LED that is flashing quickly indicates a condition that may require attention, and an unlit LED indicates that no operation is occurring. The following table defines each possible LED state.

The term ...	means that the LED ...
Slow flash	alternates on/off for 500 milliseconds.
Fast flash	alternates rapidly on/off for 100 milliseconds
On	is lit steady
Off	is unlit

LED flash patterns

The following table details the possible flash patterns to indicate various states of receiver operation.

Receiver mode	Power LED Green	Radio LED Green	Satellite LED Amber
Receiver OFF	OFF	OFF	OFF
Receiver ON:			
Healthy power	ON	N/A	N/A
Low power	Fast flash	N/A	N/A
Tracking <4 SVs	ON	N/A	Fast flash
Tracking >4 SVs	ON	N/A	Slow flash
Logging data internally	Flashes off every 3 seconds	N/A	N/A
Transmitting internally	N/A	Flashes off when transmitting	N/A
Receiving valid data packets	ON	Slow flash	N/A
No data packets	ON	OFF	N/A
Receiver in Monitor	ON	Slow flash	ON

Note – If a column shows “N/A”, that specific LED may or may not be on, but it is not relevant to that particular mode.

Starting and Stopping the Receiver

To turn on the receiver, press **[P]**.

To turn off the receiver, hold down **[P]** for two seconds.

Logging Data

You can log data internally or to a Trimble controller.

Logging internally

The Trimble R8 receiver logs GPS data internally on 6 MB of internal memory.

You can then use the Trimble Data Transfer utility to transfer logged data files to the office computer. The transferred files are in Trimble DAT (.dat) format.



WARNING – The Trimble R8 allows for a maximum of 200 files on the internal memory. The filenames must be in 8.3 format, otherwise files copied to the internal memory may cause data corruption or loss of data when logging.

Data is logged using the current logging settings configured in the receiver. Data files logged internally are named automatically.

To begin internal logging, you must use a Trimble controller, or the GPS Configurator utility. The Trimble R8 receiver does not have an internal clock, so you can only conduct timed survey sessions if the receiver has a continuous power supply.

When the internal memory is full, the receiver stops logging data, and the Logging/Memory LED switches off. Existing data files are not overwritten. You can use the Auto-delete option to override this action and automatically delete the oldest files when the receiver memory is full. However, you should use this option with caution because it can lead to data loss.

Table 14.2 shows approximate storage requirements for different logging rates. The values shown are for a one-hour logging session with six satellites visible.

Table 14.2 Storage requirements

Logging rate	Memory required
10 Hz	2,588 KB
1 Hz	335 KB
5 seconds	87 KB
15 seconds	37 KB

Logging to a Trimble controller

When the Trimble R8 receiver is connected to a Trimble controller, you can log GPS data from the receiver to the controller, or to a PC card inserted in the controller. When you use a Trimble controller, you do not use the receiver's controls. Instead, you use the controller functions to set logging options, specify filenames, and control when logging occurs.

Data is stored in job files, which can be transferred to your office computer using Trimble's Data Transfer utility.

For more information on logging data from a receiver using a Trimble controller refer to the user guide for your particular controller.

Resetting to Defaults

To reset the receiver to its factory default settings, hold down **[P]** for at least 15 seconds.

For more information, see Default Settings, page 159.

Batteries and Power



WARNING – Do not damage the rechargeable Lithium-ion battery. A damaged battery can cause an explosion or fire, and can result in personal injury and/or property damage.

To prevent injury or damage:

- Do not use or charge the battery if it appears to be damaged. Signs of damage include, but are not limited to, discoloration, warping, and leaking battery fluid.
 - Do not expose the battery to fire, high temperature, or direct sunlight.
 - Do not immerse the battery in water.
 - Do not use or store the battery inside a vehicle during hot weather.
 - Do not drop or puncture the battery.
 - Do not open the battery or short-circuit its contacts.
-

The Trimble R8 receiver can be powered by its internal battery or by an external power source connected to Port 1. Typically, one internal 2.0 ampere-hour battery provides approximately 5.5 hours of operation during an RTK survey using the internal radio in rover mode and approximately 3.5 hours of operation as an RTK base (this varies according to temperature and wireless data rate).

If an external power source is connected to Port 1 it is used in preference to the internal battery. When there is no external power source connected, or if the external power supply fails, the internal battery is used.

WARNING – Avoid contact with the rechargeable Lithium-ion battery if it appears to be leaking. Battery fluid is corrosive, and contact with it can result in personal injury and/or property damage.

To prevent injury or damage:

- If the battery leaks, avoid contact with the battery fluid.
 - If battery fluid gets into your eyes, immediately rinse your eyes with clean water and seek medical attention. Do not rub your eyes!
 - If battery fluid gets onto your skin or clothing, immediately use clean water to wash off the battery fluid.
-

The receiver is supplied with two rechargeable Lithium-ion batteries, and a dual battery charger. The two batteries charge sequentially and take approximately four hours each to fully charge.

Battery charging and storage

All battery types discharge over time when they are not being used. Batteries also discharge faster in colder temperatures. If a Lithium-ion battery is to be stored for long periods of time, make sure it is fully charged before storing and re-charged at least every three months.



WARNING – Charge and use the rechargeable Lithium-ion battery only in strict accordance with the instructions. Charging or using the battery in unauthorized equipment can cause an explosion or fire, and can result in personal injury and/or equipment damage.

To prevent injury or damage:

- Do not charge or use the battery if it appears to be damaged or leaking.
 - Charge the Lithium-ion battery only in a Trimble product that is specified to charge it. Be sure to follow all instructions that are provided with the battery charger.
 - Discontinue charging a battery that gives off extreme heat or a burning odor.
 - Use the battery only in Trimble equipment that is specified to use it.
 - Use the battery only for its intended use and according to the instructions in the product documentation.
-

Charging the Lithium-ion battery

The rechargeable Lithium-ion battery is supplied partially charged. Charge the battery completely before using it for the first time. If the battery has been stored for longer than six months, charge it before use.

To protect the battery from deep discharge (5 volts or less), the Trimble R8 system is designed to switch batteries or cease drawing power when the battery pack discharges to 5.9 volts.

A battery that has reached the deep discharge level cannot be recharged and must be replaced. The following recommendations provide optimal performance and extend the life of your batteries:

- Fully charge all new batteries prior to use.
- Do not allow the batteries to discharge below 5 volts.
- Keep all batteries on continuous charge when not in use. Batteries may be kept on charge indefinitely without damage to the receiver or batteries.
- Do not store batteries in the receiver or external charger unless power is applied.
- If you must store the batteries, fully charge them before storing and then recharge them at least every three months.

Disposing of the rechargeable Lithium-ion battery

Discharge the Lithium-ion battery before disposing of it. When disposing of the battery, be sure to do so in an environmentally sensitive manner. Adhere to any local and national regulations concerning battery disposal or recycling.

Power output

The Trimble R8 receiver does not supply power from either of its two ports.

Firmware

A receiver's *firmware* is the program inside the receiver that controls receiver operations and hardware. You can upgrade the firmware for the Trimble R8 receiver using the WinFlash utility provided on the *Trimble R7, Trimble R8, 5700, and 5800 GPS Receivers CD*.

For more information, see WinFlash Software, page 141.



WARNING – Upgrading the firmware deletes all application files on the receiver.

Configuration

In this chapter:

- Introduction
- Configuring the Receiver in Real Time
- Configuring the Receiver Using Application Files
- Application Files

Introduction

The Trimble R8 receiver has no controls for changing settings. To configure the receiver, use external software such as GPS Configurator, WinFlash, or Trimble Survey Controller.

There are two ways to configure the receiver. You can:

- configure the receiver in real time
- apply the settings in an application file

This chapter provides a brief overview of each of these methods and describes the contents and use of application files.

Configuring the Receiver in Real Time

GPS Configurator and Trimble Survey Controller support real-time configuration of the Trimble R8 receiver.

When you configure the receiver in real time, you use one of these software applications to specify which settings you want to change. When you apply the changes, the receiver settings change immediately.

Any changes that you apply to the receiver are reflected in the current application file, which is always present in the receiver. The current application file always records the most recent configuration, so if you apply further changes (either in real time or using an application file) the current file is updated and there is no record of the changes that you applied originally.

For more information on configuring the receiver in real time, see Chapter 16, Software Utilities.

Configuring the Receiver Using Application Files

An application file contains information for configuring a receiver. To configure a receiver using an application file, you need to create the application file, transfer it to the receiver, and then apply the file's settings. GPS Configurator does this for you automatically when you work with configuration files.

For more information on applying application files, see Chapter 16, Software Utilities.

Application Files

An application file is organized into records. Each record stores configuration information for a particular area of receiver operation. Application files can include the following records:

- File Storage
- General Controls
- Serial Port Baud/Format
- Reference Position
- Logging Rate
- SV Enable/Disable
- Output Message
- Antenna
- Device Control
- Static/Kinematic
- Input Message

An application file does not have to contain all of these records. When you apply an application file, any option that is not included in the records in the file remains at its current setting. For example, if you

apply an application file that only specifies the elevation mask to use, all other settings remain as they were before the application file was applied.

You can store up to twenty different application files in the receiver. You can apply an application file's settings at the time it is transferred to the receiver, or at any time afterwards.

Special application files

The Trimble R8 receiver has three special application files, which control important aspects of the receiver's configuration.

Default application file

The default application file (Default.cfg) contains the original receiver configuration, and cannot be changed. This file configures the receiver after it is reset. You can reset the receiver by holding down **[P]** for at least 15 seconds, or by using the reset option in GPS Configurator.

For more information on the default receiver settings, see Default Settings, page 159.

Although you cannot change or delete the default application file, you can use a power up application file to override any or all of the default settings.

Current application file

The current application file (Current.cfg) reflects the current receiver configuration. Whenever you change the receiver's configuration, either in real time or by applying an application file, the current file changes to match the new configuration.

You cannot delete the current file or change it directly, but every change to the receiver's current configuration is applied to the current file as well.

When you switch off the receiver then turn it on again, all the settings from the current application file are applied, so you do not lose any changes that you have made. The only exceptions are the following logging parameters:

- Logging rate
- Position rate
- Elevation mask

These parameters are always reset to the factory default values whenever the receiver is switched off.

Power Up application file

The power up application file (Power_up.cfg) is used to set the receiver to a specific configuration any time the unit is powered up.

You can specify that the receiver is reset to defaults before the power up settings are applied. This ensures that restarting the receiver always resets it to factory defaults prior to applying the power up application file.

Alternatively, you can specify that the power up settings are applied immediately after the current application file's settings have been applied. Restarting the receiver results in a configuration that uses your default settings for the options you define in the power up file, but the current settings for all other options.

By default, there is no POWER_UP application file on the receiver. To use a power up application file, you must create and save a POWER_UP application file in GPS Configurator. If you save this file to disk, the file is called Power_up.cfg. The extension .cfg is used by convention to identify application files on the office computer. When you transfer this file to the receiver, the file is saved on the receiver as POWER_UP, and becomes the new power up file.

The power up file is the only special application file that you can overwrite or delete from the receiver.

Applying application files

An application file's settings do not affect the receiver's configuration until you *apply* the application file. You can do this at the same time that you save the file. Alternatively, you can save the file on the computer or in the receiver, then open it later and apply its settings.

Storing application files

You can store application files that you create in GPS Configurator on the receiver and on the computer. For example, each file can represent a different user sharing the same receiver, or a particular mode of operation or survey style. Saving application files on your computer as well as in your receiver is optional, but it is useful because:

- it gives you a permanent copy of the settings you have sent to a receiver, for audit or your own reference.
- you can use the same file to configure multiple receivers identically.
- you can use an existing application file as a template for creating other application files with similar settings.

Naming application files

The application filename in the office computer and in the receiver are always the same. This makes it easier to recognize and keep track of your application files.

When you change the name of the application file in the receiver, this changes the application filename on your computer. When you transfer an application file from the receiver and save it to the computer, the system renames the file to match the internal receiver file. However, if you use Windows Explorer, for example, to change the .cfg filename on the computer, this *does not* change the internal receiver filename. This means that the GPS receiver does not recognize the change to the filename on the computer.

Software Utilities

In this chapter:

- Introduction
- GPS Configurator Software
- WinFlash Software

Introduction

This chapter provides information on the software utilities that you can use with the Trimble R8 receiver.

GPS Configurator Software

GPS Configurator is office software that configures selected Trimble GPS receivers.

GPS Configurator lets you:

- edit and save configuration files to the receiver and the computer
- check current receiver settings and operation
- configure receiver settings with your office computer

Installing GPS Configurator

A copy of GPS Configurator is included on the *Trimble R7, Trimble R8, 5700, and 5800 GPS Receivers CD*.

To install the software:

1. Insert the CD into the CD drive on your computer.
2. From the main menu select *Install individual software packages*.
3. Select *Install GPS Configurator vX.XX*.
4. Follow the onscreen instructions.

Configuring the Trimble R8 receiver

To configure a Trimble R8 receiver using GPS Configurator:

1. Connect Port 1 or 2 on the receiver to a serial (COM) port on the computer and apply power.
2. To start GPS Configurator, click , then select *Programs / Trimble / GPS Configurator / GPS Configurator*.
3. Select *Trimble R8* in the *Device Type* dialog.

The software automatically establishes a connection with the receiver.

4. Make appropriate selections for your required receiver settings.
For more information, refer to the GPS Configurator Help.
5. Click **Apply**.

The settings in GPS Configurator are applied to the receiver.

WinFlash Software

WinFlash communicates with Trimble products to perform various functions including:

- installing software, firmware, and option upgrades
- running diagnostics (for example, retrieving configuration information)
- configuring radios

For more information, online help is also available when using WinFlash.

Note – WinFlash runs on Microsoft Windows 95, 98, NT, 2000, Me, or XP operating systems.

Installing WinFlash

WinFlash can be installed from the *Trimble R7, Trimble R8, 5700, and 5800 GPS Receivers CD*, or from the Trimble website.

Installing WinFlash from the CD

1. Insert the disk into the CD drive on your computer.
2. From the main menu select *Install individual software packages*.
3. Select *Install WinFlash vX.XX with Trimble R8 drivers and firmware*.
4. Follow the on-screen instructions.

Upgrading firmware

Your Trimble R8 receiver is supplied with the latest version of receiver firmware installed. If a later version becomes available, upgrade the firmware installed on your receiver.

WinFlash guides you through the firmware upgrade process. The steps required are described below. For more information, refer to the WinFlash Help.

To upgrade the Trimble R8 receiver firmware:

1. Start WinFlash.
The *Device Configuration* screen appears.
2. From the *Device type* list select *Trimble R8 Receiver*.
3. From the *PC serial port* field select the serial (COM) port on the computer that the receiver is connected to.
4. Click **Next**.

The *Operation Selection* screen appears. The *Operations* list shows all of the supported operations for the selected device. A description of the selected operation is shown in the *Description* field.

5. Select GPS software upgrade and click **Next**.

The *GPS Software Selection* window appears. This screen prompts you to select the software that you want to install on the receiver.

6. Select the latest version from the *Available Software* list and click **Next**.

The *Settings Review* window appears. This screen prompts you to connect the receiver, suggests a connection method, and then lists the receiver configuration and selected operation.

7. If all is correct, click **Finish**.

Based on the selections shown above, the *Software Upgrade* window appears and shows the status of the operation (for example, Establishing communication with the Trimble R8. Please wait ...)

8. Click **OK**.

The *Software Upgrade* window appears again and states that the operation was completed successfully.

9. Click **Menu** to select another operation, or click **Exit** to quit WinFlash.

10. If you click **Exit**, another screen appears asking you to confirm that you want to quit WinFlash. Click **OK**.

Adding frequencies for the 450 MHz internal radio

If your Trimble R8 receiver has the optional internal 450 MHz radio installed, you must use WinFlash to add receiving frequencies to the default list. If you purchased the transmit option, the broadcast frequencies must be programmed at the factory.

To add radio receiving frequencies:

1. Start WinFlash.
The *Device Configuration* screen appears.
2. From the *Device type* list select *Trimble R8 Receiver*.
3. From the *PC serial port* field select the serial (COM) port on the computer that the receiver is connected to.
4. Click **Next**.

The *Operation Selection* screen appears. The *Operations* list shows all of the supported operations for the selected device. A description of the selected operation is shown in the *Description* field.

5. Select Configure Radio and click **Next**.

The *Frequency Selection* window appears:

Frequency Selection

You have connected to a Trimble R8 Internal

Frequency Band: 410.0 - 430.0 MHz

Wireless Format:

Current Channel: 1 - 419.550 MHz

Wireless Mode: TRIMTALK 450S at 9600 bps

Note: Wireless mode must be common among all radios in your network.

Channel Frequency

Specify Frequency:

419.5500 MHz Add

Selected Frequencies:

Channel	Frequency
1	419.5500
2	420.0000
3	430.0000

Remove
Remove All
Move Up
Move Down

OK
Cancel
Radio Info...
Save...
Print

6. In the *Wireless Format* group, select the appropriate channel and wireless mode. The Wireless Mode must be the same for all radios in your network.
7. In the *Specify Frequency* field, enter the frequency you require.

8. Click **Add**. The new frequency appears in the *Selected Frequencies* list.

*Note – The frequencies that you program must conform to the channel spacing and minimum tuning requirements for the radio. To view this information, click **Radio Info**. You may select either 12.5 or 25 kHz channel spacing. All radios in your network must use the same channel spacing.*

9. When you have configured all the frequencies you require, click **OK**.

WinFlash updates the receiver radio frequencies and then restarts the receiver.

Note – You can only configure receive frequencies. The FCC approved transmit frequencies must be specified and configured by Trimble.

Configuring the internal 900 MHz radio setup

To configure the internal 900 MHz radio, use one of the following:

- Trimble Survey Controller running on a Trimble controller
- WinFlash (provided on the *Trimble R7, Trimble R8, 5700, and 5800 GPS Receivers CD*)

The internal radio has 40 available networks. You must choose the same network that is configured in the base radio you want to receive from.

Trimble Survey Controller

To configure your radio network using Trimble Survey Controller:

1. Connect to the Trimble R8 receiver with Bluetooth (or the appropriate data cable if necessary).
2. From the main menu on the controller, select *Configuration*.
3. In the dialog that appears, select *Survey styles*, then from the *Type* field, select *RTK*.

4. Select *Rover radio*, then from the *Type* field select *Trimble Internal*.
5. Tap the **Connect** softkey.
6. Once connected, in the *Network number* field enter the number of the network set on your base radio.
Note – The Base Radio Mode field is not used here.
7. Tap the **Enter** softkey to complete configuration.

WinFlash

To configure the radio network using WinFlash:

1. Connect the data/power cable to Port 1 on the receiver.
2. Connect the female DE-9 connector on the other end of the data/power cable to a serial (COM) port on the computer.
3. Start WinFlash. The *Device Configuration* dialog appears.
4. From the *Device type* list, select *Trimble R8 Receiver*.
5. From the *PC serial port* field, select the serial port on the computer that the receiver is connected to and click **Next**.
6. From the *Operation selection* dialog, select *Configure radio* and click **Next**.
7. Confirm that your current settings are correct and click **Finish**. The *Configure 900MHz radio* dialog appears.
8. In the *Network number* field, select the same network that is set on your base radio.
9. In the *Country setting* field, select one of the following (according to how your base radio was shipped):
 - Your country (if available). This sets the radio to the a specific frequency range being transmitted by the base radio.
 - A single frequency. This limits the frequencies used to those authorized in your particular country.
10. Click **OK**.

WinFlash updates the radio settings and then restarts the receiver.

Configuring the internal transceiver

Use the WinFlash *Internal Transceiver Configuration* dialog to configure the Trimble R8 internal transceiver.



Tip – To view a list of all radio information, including the current configuration, click **Radio Info**.

1. Select the *Current Channel*, which determines the radio operating frequency.
2. Select the *Wireless Mode*, which determines the over-the-air communications parameters. The following example shows a rover setup:

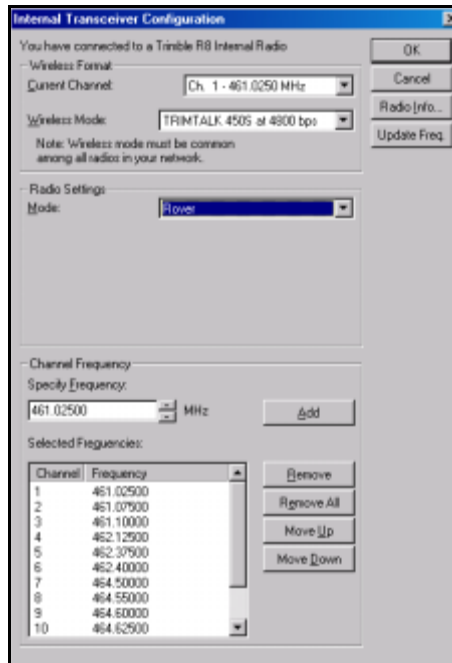

To reduce battery consumption on your base receiver, set the wireless mode as high as possible. For example, 9600 bps consumes half the power of 4800 bps for the same data format and time of operation.

Note – All radios in the network must be configured with the same wireless setting.

3. Select the appropriate operating mode, depending on how you intend to use the receiver, for example, *Base with No Repeaters*:

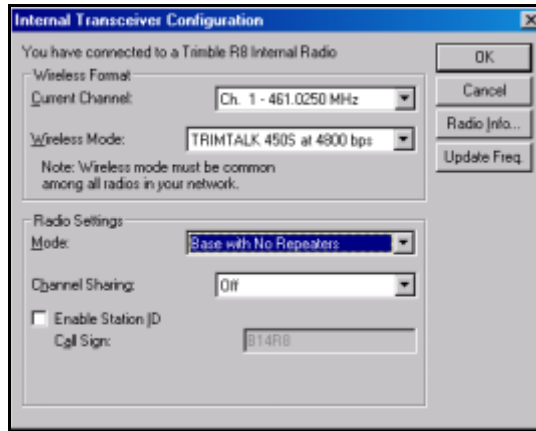

4. Select one of the following channel sharing configurations (base modes only; not available for rover):

- Off. The carrier detect mode is off. The unit will ignore other transmissions on your frequency and continue to transmit data.

Note – It may be illegal in your country of use to set channel sharing to Off. You may be subject to penalties or fines based upon the specific licensing requirements for your country of use. Please consult your radio license documentation or licensing agency for operational guidelines.

- Avoid Weak Signals. The carrier detect mode is on. The radio will cease transmitting if it detects another radio transmission on its frequency. It will resume transmission when the channel is free of radio traffic.

- Avoid Strong Signals. The carrier detect mode is on, but the radio will stop transmitting only when there is a strong signal present (receive level greater than 90 dBm).
5. If you are operating in Base mode, select the *Enable Station ID* check box and then enter your call sign in the *Call Sign* field. This FCC requirement is for U.S. licensed users. It sets your radio to transmit your call sign in Morse code every 15 minutes.
 6. To update the configuration, click **OK**.

In the *Status* dialog that appears, select an option to return to the main menu or to exit WinFlash.



Tip – You can print or save the radio configuration information for future reference. If required, you can fax or e-mail the file to Trimble Support to aid in troubleshooting radio problems.

Updating the frequency list

You can program the internal transceiver modem with a list of up to 20 frequencies, which are stored in non-volatile memory. This list is pre-configured based on the frequencies that you requested when you ordered the unit. Government regulations stipulate that only manufacturers or authorized dealers can create this frequency list and that all frequencies programmed into a unit must comply with the host country regulations. If you need to add, delete, or replace frequencies, contact your Trimble dealer, and provide the radio modem serial number and an updated list of the frequencies you require. Once you receive the frequency file, you can upgrade the radio using WinFlash.

Specifications

In this chapter:

- Introduction
- Physical Specifications
- Positioning Specifications
- Technical Specifications

Introduction

This chapter details the specifications of the Trimble R8 receiver.

Physical Specifications

Table 17.1 lists physical specifications for the Trimble R8 receiver.

Table 17.1 Physical specifications

Feature	Specification
Size	19cm (7.5") wide x 10cm (3.9") deep including connectors
Weight: with internal battery and radio	1.31 kg (2.13 lbs)
Operating times on internal battery	450 MHz receive/transmit: 3.5 hours (varies with temperature and wireless data rate) GSM: 3.8 hours (varies with temperature)
Battery life (at 20 °C)	Approximately 5.5 hours for one 2.0 ah Lithium-ion battery
External Power input	11–28 V DC
Operating temperature ^a	–40 °C to +65 °C (–40 °F to +149 °F)
Storage temperature	–40 °C to +70 °C (–40 °F to +157 °F)
Humidity	100% condensing, unit fully sealed
Casing	Dust-proof, shock- and vibration-resistant

^aReceiver will operate normally to –40 °C. Bluetooth module, GSM module, and internal batteries are rated to –20 °C.

Positioning Specifications

Table 17.2 lists positioning specifications for the Trimble R8 receiver.

Table 17.2 Positioning specifications

Positioning	Mode	Horizontal accuracy (RMS)	Vertical accuracy (RMS)
RTK (OTF)	Synchronized	1 cm + 1 ppm (× baseline length)	2 cm + 1 ppm (× baseline length)
	Low Latency	2 cm + 2 ppm (× baseline length) ^a	3 cm + 2 ppm (× baseline length) ^a
L1 C/A Code Phase	Synchronized/ Low Latency	.25m + 1ppm RMS	.50m + 1ppm RMS
Static/ FastStatic	N/A	5 mm + 0.5 ppm (× baseline length)	5 mm + 1 ppm (× baseline length)
WAAS	N/A	Less than 5 m ^b	Less than 5 m ^b

^aDepends on radio link latency.

^b3D RMS values depend on WAAS system performance.

Technical Specifications

Table 17.3 lists technical specifications for the Trimble R8 receiver.

Table 17.3 Technical specifications

Feature	Specification
Tracking	24 Channels L1 C/A Code, L2C, L1/L2 Full Cycle Carrier, WAAS/EGNOS support Fully operational during P-code encryption WAAS satellite tracking
Signal processing	Maxwell V architecture Very low-noise C/A code processing Multipath suppression
Start-up	Cold start: < 60 seconds from power on Warm start: < 30 seconds with recent ephemeris
Initialization	Automatic while moving or static
Minimum initialization time	10 sec + 0.5 × baseline length (km)
Communications	Two RS-232 serial ports (Port 1, Port 2,) Port 1: Baud Rates up to 115,200 bps Port 2: Baud Rates up to 115,200 bps RTS/CTS flow control negotiation supported on Port 2 only Bluetooth communications with Trimble ACU or TSCe with Bluecap module

Table 17.3 Technical specifications (continued)

Feature	Specification
Transmit radio	Transmit power: 0.5 watts Wireless data rate: 4800, 8000, 9600, 16000, and 19200 Frequency bands: 410-430MHz, 430-450MHz, 450-470MHz Channel Spacing: 12.5kHz and 25kHz Number of channels: Total of 20 factory pre-programmed transmit frequencies or user configured receive frequencies RF modulation format: Gaussian Minimum Shift Keying (GMSK) at 4800, 8000, 9600, 16000, and 19200 bps Range: Optimal 10 km (line of sight); Typical: 3–5 km (varies with terrain and operational conditions) Battery life: Up to 3.5 hours (varies with temperature and wireless data rate)
GSM module	Certification: Class B Part 15, 22, 24 FCC certification: 850/1900 Class 10 GSM module CE Mark approval C-tick approval GSM: type approvals are country specific. For more information, contact your Trimble representative.
Bluetooth	Type approvals are country specific. For more information, contact your Trimble representative.
Configuration	Through user-definable application files or GPS Configurator
Output formats	NMEA-0183: AVR; GGA; GSA; GST; GSV; PTNL,GGK; PTNL,GGK_SYNC; HDT; PTNL,PJK; PTNL,PJT; ROT; PTNL,VGK; VHD; VTG; ZDA GSOF (Trimble Binary Streamed Output) RT17

Default Settings

In this chapter:

- Introduction
- Default Settings
- Resetting to Factory Defaults

Introduction

All Trimble R8 receiver settings are stored in application files. The default application file, `DEFAULTS` is stored permanently in the receiver, and contains the factory default settings for the receiver. Whenever the receiver is reset to its factory defaults, the current settings (stored in the current application file, `CURRENT`) are reset to the values in the default application file.

You cannot modify the default application file. However, if there is a power up application file (`POWER_UP`) in the receiver, the settings in this file can be applied immediately after the default application file, overriding the factory defaults.

For more information about application files, see *Application Files*, page 135.

Default Settings

Table 18.1 defines the default settings for the Trimble R8 receiver, as defined in the default application file.

Table 18.1 Default settings

Function		Factory default
SV Enable		All SVs enabled
General Controls:	Elevation mask	13°
	PDOP mask	7
	RTK positioning mode	Low Latency
	Motion	Kinematic
Serial Port 1:	Baud rate	115,200
	Format	8-None-1
	Flow control	None
Serial Port 2:	Baud rate	115,200
	Format	8-None-1
	Flow control	None
Input Setup:	Station	Any
NMEA/ASCII (all messages)		All Ports Off
Streamed output		All Types Off Offset = 00
RT17/Binary		All Ports Off
Reference position:	Latitude	0°
	Longitude	0°
	Altitude	0.00 m HAE
Antenna:	Type	Trimble R8/5800 Internal
	Height (true vertical)	0.00 m
	Group	All
	Measurement method	Bottom of mount

Resetting to Factory Defaults

To reset the Trimble R8 receiver to its factory defaults, do one of the following:

- Press and hold down **(P)** on the receiver for 15 seconds.
- In GPS Configurator, select *Connect to Receiver* and then click **Reset receiver** in the *General* tab.

Default behavior

The factory defaults specified above are applied whenever you start the receiver. If a Power Up file is present in the receiver, its settings are applied immediately after the default settings, so you can use a Power Up file to define your own set of defaults.

Power up settings

When you turn the receiver off, any changes that you have made to logging settings are lost and these settings are returned to the factory defaults. Other settings remain as defined in the Current file. The next time you turn on the receiver, the receiver checks for a Power Up file and, if one is present, applies the settings in this file.

When you use (P) to turn the receiver off then on again and ...	then logging settings are ...	and all other settings are ...
you changed the receiver settings by applying an application file	the factory defaults	the last settings used
you changed the receiver settings using configuration software	the factory defaults	the last settings used
there is a Power Up application file in the receiver	the factory defaults, or those in the Power Up file ^a	the last settings used, or those in the Power Up file

^aA factory default setting is used only if the setting is not defined in the Power Up file.

Cables and Connectors

In this chapter:

- Introduction
- Port 1 and 2 Connectors
- Power/serial Data Cable

Introduction

This chapter provides pinout information for the Trimble R8 receiver standard and optional cables. This information can be used to prepare special cables for connecting the receiver to devices and instruments not supported by the standard and optional cables.

Port 1 and 2 Connectors

Figure 19.1 shows the location of the Trimble R8 serial ports.

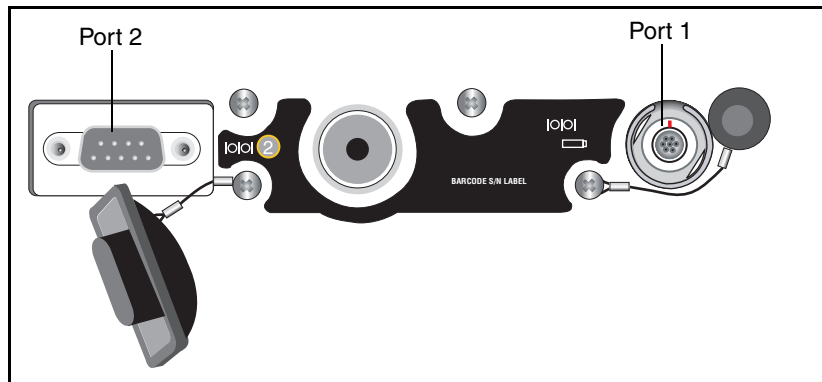

Figure 19.1 Trimble R8 serial ports

Figure 19.2 gives pinout requirements for the connector labeled Port 1.

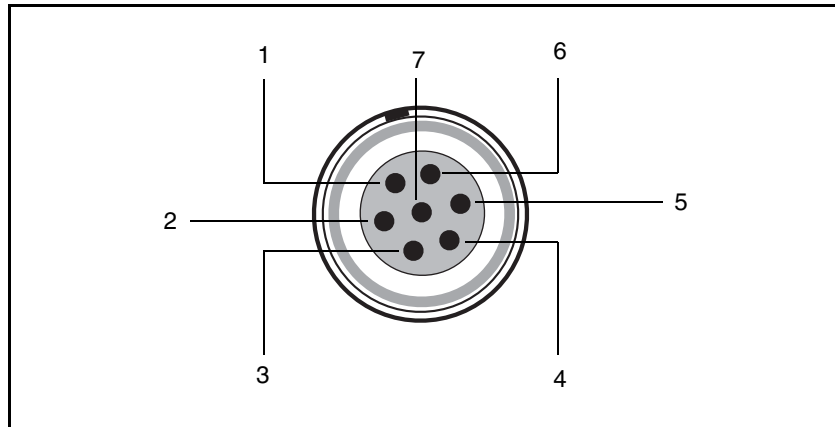

Figure 19.2 Port 1 connector

Figure 19.3 gives pinout requirements for the connector labeled Port 2.

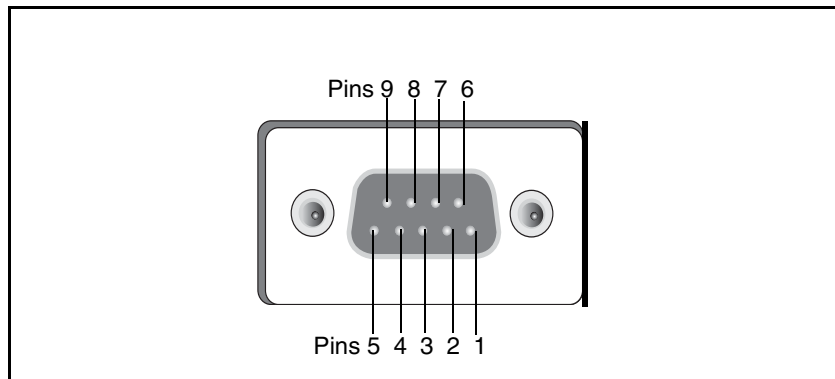

Figure 19.3 Port 2 connector

Table 19.1 describes the pinout functionality.

Table 19.1 Trimble R8 port pinouts

Pin	Pinout function	
	Port 1 - 7-pin Lemo	Port 2 - DB-9
1	Signal ground	DCD
2	- Power ground	RXD
3	TXD	TXD
4	N/C	DTR
5	N/C	Signal ground
6	+ Power in	DSR
7	TRXD	RTS
8	N/A	CTS
9	N/A	Ring indicator

Power/Serial Data Cables

Note – Table 19.2 gives pinout information for the data-I/O cable, (PN 18532) which is supplied with the Trimble R8 receiver

Note – Table 19.2 assumes that the cable is attached to the connector labeled Port 2.

Table 19.2 Data-I/O cable pinouts

DB-9 Female 9 Pin		DB-9 Female 9 pin	
Pin	Function	Pin	Function
1-6	DCD5_232	4	DTR5_232
2	RX5_232	3	TX5_232
3	TX5_232	2	RX5_232
4	DTR5_232	1-6	DCD5_232

Table 19.2 Data-I/O cable pinouts (continued)

DB-9 Female 9 Pin		DB-9 Female 9 pin	
Pin	Function	Pin	Function
5	GND	5	GND
7	RTS5_232	8	CTS5_232
8	CTS5_232	7	RTS5_232
9	no connection RI5_232	9	

This data cable may be used for firmware upgrades and other computer functions with the Trimble R8. Power must be supplied to the receiver via Port 1, or from the internal battery.

Note – Table 19.3 gives pinout information for the power/serial data cable, (PN 32345) which is optional for use with the Trimble R8 receiver. This cable can be used for firmware upgrades through Port 1, while also supplying external power.

Note – Table 19.3 assumes that the cable is attached to the connector labeled Port 1.

Table 19.3 Power/serial data cable pinouts

Lemo 0-shell connector 7 Pin		Direction	DE9-F connector 7 Cond			Power lead 2 Cond	
Pin	Function		Pin	Color	Function	Color	Function
1	GND	↔	5	Brown	Signal ground		
2	GND	→				Black	V-OUT
3	TX3_232	→	2	Orange	TXD		
4	RTS/TXD	→	8	Blue	RTS		
5	CTS/RXD	←	7	Green	CTS		
6	PWR_IN	←				Red	Power IN (+)
7	RX3_232	←	3	Yellow	TXD		

SECTION

III

APPENDIXES TRIMBLE R7 / TRIMBLE R8

NMEA-0183 Output

In this appendix:

- Introduction
- NMEA-0183 outputs
- Common message elements
- NMEA messages

Introduction

This appendix describes the formats of the subset of NMEA-0183 messages that are available for output by the receivers. For a copy of the NMEA-0183 Standard, visit the National Marine Electronics Association website at www.nmea.org.

NMEA-0183 Outputs

When NMEA-0183 output is enabled, a subset of NMEA-0183 messages can be output to external instruments and equipment connected to the Trimble R7 serial ports. These NMEA-0183 messages let external devices use selected data collected or computed by the GPS receiver.

All messages conform to the NMEA-0183 Version 3.01 format. All begin with \$ and end with a carriage return and a line feed. Data fields follow comma (,) delimiters and are variable in length. Null fields still follow comma (,) delimiters but contain no information.

An asterisk (*) delimiter and checksum value follow the last field of data contained in an NMEA-0183 message. The checksum is the 8-bit exclusive *OR* of all characters in the message, including the commas between fields, but not including the \$ and asterisk delimiters. The hexadecimal result is converted to two ASCII characters (0–9, A–F). The most significant character appears first.

Table A.1 summarizes the set of NMEA messages supported by the Trimble R7 receiver, and shows the page where detailed information about each message can be found.

Table A.1 NMEA message summary

Message	Function	Page
AVR	Time, yaw, tilt, range, mode, PDOP, and number of SVs for Moving Baseline RTK	174
GGA	Time, position, and fix related data	175
GSA	GNSS DOP and active satellites	176

Table A.1 NMEA message summary (continued)

Message	Function	Page
GST	Position error statistics	177
GSV	Number of SVs in view, PRN, elevation, azimuth, and SNR	178
HDT	Heading from True North	178
PTNL,GGK	Time, position, position type and DOP values	179
PTNL,GGK_SYNC	Time, synchronized position, position type and DOP values	180
PTNL,PJK	Local coordinate position output	182
PTNL,PJT	Projection type	183
PTNL,VGK	Time, locator vector, type and DOP values	183
PTNL,VHD	Heading Information	184
ROT	Rate of turn	185
VTG	Actual track made good and speed over ground	186
ZDA	UTC day, month, and year, and local time zone offset	187

To enable or disable the output of individual NMEA messages, do one of the following:

- create an application file in GPS Configurator that contains NMEA output settings and then send the file to the receiver.
- add NMEA outputs in the *Serial outputs* tab of GPS Configurator and then apply the settings.

Common Message Elements

Each message contains:

- A message ID consisting of *\$GP* followed by the message type. For example, the message ID of the GGA message is *\$GPGGA*.
- A comma
- A number of fields that depend on message type, separated by commas
- An asterisk
- A checksum value

Below is an example of a simple message with a message ID (*\$GPGGA*), followed by 13 fields and checksum value:

```
$GPGGA,172814.0,3723.46587704,N,12202.26957864,W,2,6,1.2,18.893,M,-25.669,M,2.0,0031*4F
```

Message values

The following values can be found in NMEA messages that the receiver generates.

Latitude and Longitude

Latitude is represented as *ddmm.mmmm* and longitude is represented as *dddmm.mmmm*, where:

- *dd* or *ddd* is degrees
- *mm.mmmm* is minutes and decimal fractions of minutes

Direction

Direction (north, south, east, or west) is represented by a single character: *N*, *S*, *E*, or *W*.

Time

Time values are presented in Universal Time Coordinated (UTC) and are represented as *hhmmss.cc*, where:

- *hh* is hours, from 00 to 23
- *mm* is minutes
- *ss* is seconds
- *cc* is hundredths of seconds

NMEA Messages

When NMEA-0183 output is enabled, the following messages can be generated.

AVR Time, Yaw, Tilt, Range for Moving Baseline RTK

The AVR message string is shown below, and Table A.2 describes the message fields.

```
$PTNL,AVR,181059.6,+149.4688,Yaw,+0.0134,Tilt,,,60.191,3,
2.5,6*00
```

Table A.2 AVR message fields

Field	Meaning
1	UTC of vector fix
2	Yaw angle in degrees
3	Yaw
4	Tilt angle in degrees
5	Tilt
6	Reserved
7	Reserved
8	Range in meters
9	Quality indicator: 0: Fix not available or invalid 1: Autonomous GPS fix 2: Differential carrier phase solution RTK (Float) 3: Differential carrier phase solution RTK (Fix) 4: Differential code-based solution, DGPS
10	PDOP
11	Number of satellites used in solution

GGA Time, Position, and Fix Related Data

An example of the GGA message string is shown below. Table A.3 describes the message fields.

```
$GPGGA,172814.0,3723.46587704,N,12202.26957864,W,
2,6,1.2,18.893,M,-25.669,M,2.0,0031*4F
```

Table A.3 GGA message fields

Field	Meaning
1	UTC of position fix
2	Latitude
3	Direction of latitude: N: North S: South
4	Longitude
5	Direction of longitude: E: East W: West
6	GPS Quality indicator: 0: Fix not valid 1: GPS fix 2: Differential GPS fix 4: Real Time Kinematic, fixed integers 5: Real Time Kinematic, float integers
7	Number of SVs in use, range from 00 to 12
8	HDOP
9	Orthometric height (MSL reference)
10	M: unit of measure for height is meters
11	Geoid separation
12	M: geoid separation is measured in meters

Table A.3 GGA message fields (continued)

Field	Meaning
13	Age of differential GPS data record, Type 1 or Type 9. Null field when DGPS is not used.
14	Reference station ID, ranging from 0000 to 1023. A null field when any reference station ID is selected and no corrections are received.

GSA GNSS DOP and active satellites

An example of the GSA message string is shown below. Table A.4 describes the message fields.

```
$GPGSA,<1>,<2>,<3>,<3>,,,,,<3>,<3>,<3>,<4>,<5>,<6>*<7><CR><LF>
```

Table A.4 GSA message fields

Field	Meaning
1	Mode 1, M = manual, A = automatic
2	Mode 2, Fix type, 1 = not available, 2 = 2D, 3 = 3D
3	PRN number, 01 to 32, of satellite used in solution, up to 12 transmitted
4	PDOP-Position dilution of precision, 0.5 to 99.9
5	HDOP-Horizontal dilution of precision, 0.5 to 99.9
6	VDOP-Vertical dilution of precision, 0.5 to 99.9
7	Checksum

GST **Position Error Statistics**

An example of the GST message string is shown below. Table A.5 describes the message fields.

```
$GPGST,172814.0,0.006,0.023,0.020,273.6,
0.023,0.020,0.031*6A
```

Table A.5 **GST message fields**

Field	Meaning
1	UTC of position fix
2	RMS value of the pseudorange residuals (includes carrier phase residuals during periods of RTK(float) and RTK(fixed) processing)
3	Error ellipse semi-major axis 1 sigma error, in meters
4	Error ellipse semi-minor axis 1 sigma error, in meters
5	Error ellipse orientation, degrees from true north
6	Latitude 1 sigma error, in meters
7	Longitude 1 sigma error, in meters
8	Height 1 sigma error, in meters

GSV Satellite Information

The GSV message string identifies the number of SVs in view, the PRN numbers, elevations, azimuths, and SNR values. An example of the GSV message string is shown below. Table A.6 describes the message fields.

```
$GPGSV,4,1,13,02,02,213,,03,-3,000,,
11,00,121,,14,13,172,05*67
```

Table A.6 GSV message fields

Field	Meaning
1	Total number of messages of this type in this cycle
2	Message number
3	Total number of SVs visible
4	SV PRN number
5	Elevation, in degrees, 90° maximum
6	Azimuth, degrees from True North, 000° to 359°
7	SNR, 00–99 dB (null when not tracking)
8–11	Information about second SV, same format as fields 4–7
12–15	Information about third SV, same format as fields 4–7
16–19	Information about fourth SV, same format as fields 4–7

HDT Heading from True North

The HDT string is shown below, and Table A.7 describes the message fields.

```
$GPHDT,123.456,T*00
```

Table A.7 Heading from true north fields

Field	Meaning
1	Heading in degrees
2	T: Indicates heading relative to True North

PTNL,GGK

Time, Position, Position Type, DOP

An example of the PTNL,GGK message string is shown below.
Table A.8 describes the message fields.

```
$PTNL,GGK,172814.00,071296,  
3723.46587704,N,12202.26957864,W,  
3,06,1.7,EHT-6.777,M*48
```

Table A.8 PTNL,GGK message fields

Field	Meaning
1	UTC of position fix
2	Date
3	Latitude
4	Direction of latitude: N: North S: South
5	Longitude
6	Direction of Longitude: E: East W: West
7	GPS Quality indicator: 0: Fix not available or invalid 1: Autonomous GPS fix 2: Differential, floating carrier phase integer-based solution, RTK(float) 3: Differential, fixed carrier phase integer-based solution, RTK(fixed) 4: Differential, code phase only solution (DGPS)
8	Number of satellites in fix
9	DOP of fix

Table A.8 PTNL,GGK message fields (continued)

Field	Meaning
10	Ellipsoidal height of fix
11	M: ellipsoidal height is measured in meters

Note – The PTNL,GGK message is longer than the NMEA-0183 standard of 80 characters.

PTNL,GGK_SYNC

Time, Synchronized Position, Position Type, DOP

The PTNL,GGK_SYNC message has the same format as the PTNL,GGK message, but outputs Synchronized 1 Hz positions even in Low Latency mode. An example of the PTNL,GGK_SYNC message string is shown below. Table A.9 describes the message fields.

```
$PTNL,GGK_SYNC,172814.00,071296,
3723.46587704,N,12202.26957864,W,
3,06,1.7,EHT-6.777,M*48
```

Table A.9 PTNL,GGK_SYNC message fields

Field	Meaning
1	UTC of position fix
2	Date
3	Latitude
4	Direction of latitude: N: North S: South
5	Longitude

Table A.9 PTNL,GGK_SYNC message fields (continued)

Field	Meaning
6	Direction of Longitude: E: East W: West
7	GPS Quality indicator: 0: Fix not available or invalid 1: Autonomous GPS fix 2: Differential, floating carrier phase integer-based solution, RTK(float) 3: Differential, fixed carrier phase integer-based solution, RTK(fixed) 4: Differential, code phase only solution (DGPS)
8	Number of satellites in fix
9	DOP of fix
10	Ellipsoidal height of fix
11	M: ellipsoidal height is measured in meters

Note – The PTNL,GGK_SYNC message is longer than the NMEA-0183 standard of 80 characters.

PTNL,PJK

Local Coordinate Position Output

An example of the PTNL,PJK message string is shown below. Table A.10 describes the message fields.

```
$PTNL,PJK,010717.00,081796,
+732646.511,N,+1731051.091,E,
1,05,2.7,EHT-28.345,M*7C
```

Table A.10 PTNL,PJK message fields

Field	Meaning
1	UTC of position fix
2	Date
3	Northing, in meters
4	Direction of Northing will always be N (North)
5	Easting, in meters
6	Direction of Easting will always be E (East)
7	GPS Quality indicator: 0: Fix not available or invalid 1: Autonomous GPS fix 2: Differential, floating carrier phase integer-based solution, RTK (float) 3: Differential, fixed carrier integer-based solution, RTK (fixed) 4: Differential, code phase only solution (DGPS)
8	Number of satellites in fix
9	DOP of fix
10	Ellipsoidal height of fix
11	M: ellipsoidal height is measured in meters

Note – The PTNL,PJK message is longer than the NMEA-0183 standard of 80 characters.

PTNL,PJT

Projection Type

An example of the PTNL,PJT message string is shown below.
Table A.11 describes the message fields.

```
$PTNL,PJT,NAD83(Conus),California Zone 4 0404,*51
```

Table A.11 PTNL,PJT message fields

Field	Meaning
1	Coordinate system name (can include multiple words)
2	Projection name (can include multiple coordinates)

PTNL,VGK

Vector Information

An example of the PTNL,VGK message string is shown below.
Table A.12 describes the message fields.

```
$PTNL,VGK,160159.00,010997,-0000.161,  
00009.985,-0000.002,3,07,1,4,M*0B
```

Table A.12 PTNL,VGK message fields

Field	Meaning
1	UTC of vector in hhmmss.ss format
2	Date in mmddyy format
3	East component of vector, in meters
4	North component of vector, in meters
5	Up component of vector, in meters

Table A.12 PTNL,VGK message fields (continued)

Field	Meaning
6	GPS quality indicator: 0: Fix not available or invalid 1: Autonomous GPS fix 2: Differential carrier phase solution RTK(float) 3: Differential carrier phase solution RTK(fix) 4: Differential code-based solution, DGPS
7	Number of satellites if fix solution
8	DOP of fix
9	M: Vector components are in meters

PTNL,VHD

Heading Information

An example of the PTNL,VHD message string is shown below. Table A.13 describes the message fields.

```
$PTNL,VHD,030556.00,093098,187.718,  
-22.138,-76.929,-5.015,0.033,0.006,  
3,07,2.4,M*22
```

Table A.13 PTNL,VHD message fields

Field	Meaning
1	UTC of position, in <i>hhmmss.ss,ddmmyy</i> format
2	Date in <i>mmddy</i> format
3	Azimuth
4	Δ Azimuth/ Δ Time
5	Vertical Angle
6	Δ Vertical/ Δ Time
7	Range

Table A.13 PTNL,VHD message fields (continued)

Field	Meaning
8	Δ Range/ Δ Time
9	Quality indicator: 0: Fix not available or invalid 1: Autonomous GPS fix 2: Differential carrier phase solution RTK(float) 3: Differential carrier phase solution RTK(fix) 4: Differential code-based solution, DGPS
10	Number of satellites used in solution
11	PDOP

ROT Rate of Turn

The ROT string is shown below, and Table A.14 describes the message fields.

```
$GPROT,35.6,A*4E
```

Table A.14 ROT message fields

Field	Meaning
1	Rate of turn, degrees/minutes, "-" indicates bow turns to port
2	A: Valid data V: Invalid data

VTG Actual Track Made Good Over and Speed Over Ground

An example of the VTG message string is shown below. Table A.15 describes the message fields.

```
$GPVTG,,T,,M,0.00,N,0.00,K*4E
```

Table A.15 VTG message fields

Field	Meaning
1	Track made good (degrees true)
2	T: track made good is relative to true north
3	Track made good (degrees magnetic)
4	M: track made good is relative to magnetic north
5	Speed, in knots
6	N: speed is measured in knots
7	Speed over ground in kilometers/hour (kph)
8	K: speed over ground is measured in kph

ZDA UTC Day, Month, And Year, and Local Time Zone Offset

An example of the ZDA message string is shown below. Table A.16 describes the message fields.

```
$GPZDA,172809,12,07,1996,00,00*45
```

Table A.16 ZDA message fields

Field	Meaning
1	UTC
2	Day, ranging between 01 and 31
3	Month, ranging between 01 and 12
4	Year
5	Local time zone offset from GMT, ranging from 00 to ± 13 hours
6	Local time zone offset from GMT, ranging from 00 to 59 minutes

Fields 5 and 6 together yield the total offset. For example, if field 5 is -5 and field 6 is $+15$, local time is 5 hours and 15 minutes earlier than GMT.

RTCM Output

In this appendix:

- RTCM Output
- Message Scheduling

RTCM Output

Table B.1 shows the messages that are generated when you select a specific RTCM version. The messages in the table are in the same order as they appear in GPS Configurator. For the details of the contents of individual messages, refer to the RTCM documentation.

Table B.1 RTCM output

Selection	Message								
Version 2	1	3			22				59
USCG 9-3		3	9-3						
RTCM/RTK 2.2+2.3	1	3		18	19	22	23	24	59
RTK Only 2.2+2.3		3		18	19	22	23	24	59
RTCM/RTK 2.3	1			18	19		23	24	
RTK Only 2.3				18	19	22			
RTCM/RTK 2.2	1	3		18	19	22			59
RTK Only 2.2		3		18	19	22			59
RTCM/RTK 2.1	1	3		18	19	22			59
RTK Only 2.1		3		18	19	22			59
RTCM/RTK 3.00						1004	1006	1008	1013

Message Scheduling

Table B.2 describes the frequency at which messages are generated when they are enabled in a base receiver.

Table B.2 Message scheduling

Type	Frequency
1	Every second
3	The 10th second after the first measurement, then every 10 seconds after that
9-3	Every second
18	Every second
19	Every second
22	The 5th second after the first measurement, then every 10 seconds after that
23	The 4th second after the first measurement, then every 10 seconds after that
24	The 4th second after the first measurement, then every 10 seconds after that
59-sub, 13	The 5th second after the first measurement, then every 10 seconds after that
1004	Every second
1006	Every 10 seconds
1008	Every 10 seconds
1013	Every 300 seconds

Troubleshooting

In this appendix:

- LED Conditions
- Receiver Issues

An LED that is flashing quickly indicates a condition that may require attention, and an unlit LED indicates that no operation is occurring. Table C.1 describes some LED conditions, possible causes, and how to solve them.

Table C.1 LED conditions

Condition	Possible cause	Solution
The SV Tracking LED is lit solidly and the Logging/Memory LED is flashing slowly.	The receiver is in Monitor mode, ready for new firmware to be loaded or new options to be added.	Power the receiver off or on. Load the latest version of the firmware, which you can download from www.trimble.com/support.html
The SV Tracking LED is not flashing.	The receiver is tracking fewer than four satellites. The radio antenna cable and GPS antenna cable are mixed up.	Wait until the SV Tracking LED is flashing slowly. Make sure that the GPS antenna cable (with the yellow over-mould) is connected between the yellow TNC connector marked GPS and the GPS antenna.

Table C.2 describes some possible receiver issues, possible causes, and how to solve them.

Table C.2 Receiver issues

Issue	Possible cause	Solution
The receiver does not power up.	External power too low.	Check the charge on the external battery, and check the fuse if applicable. Replace the battery if necessary.
	Internal power too low.	Check the charge on the internal batteries and replace if necessary. Ensure battery contacts are clean.
	External power not properly connected.	Check that the Lemo connection is seated properly. Check for broken or bent pins in the connector.
	Faulty power cable.	Try a different cable. Check pinouts with multimeter to ensure internal wiring is intact.

Table C.2 Receiver issues (continued)

Issue	Possible cause	Solution
Receiver does not log data.	Insufficient memory on the CompactFlash card.	Delete old files using the GPS Configurator or Trimble Survey Controller software, or by holding down (Ⓢ) for 30 seconds.
	No CompactFlash card is inserted.	Insert a CompactFlash card in the receiver.
	The CompactFlash card is not seated properly.	Remove the Compact Flash card and reinsert it, making sure that it slides into the housing easily and seats into the pins.
	The receiver is tracking fewer than four satellites.	Wait until the SV Tracking LED is flashing slowly.
	The CompactFlash card is not formatted, or is corrupted.	Format the CompactFlash card using GPS Configurator, or by holding down (Ⓢ) for 30 seconds. If the problem persists, use GPS Configurator to perform a full format.
The receiver is not responding.	Receiver needs soft reset.	Power down the receiver and power back up.
	Receiver needs full reset.	Hold down (Ⓢ) for 30 seconds. If you want to retain data files, remove the CompactFlash card first.

Table C.2 Receiver issues (continued)

Issue	Possible cause	Solution
Reference receiver is not broadcasting.	Port settings between reference receiver and radio are incorrect.	Using Trimble Survey Controller, connect to the reference radio through the receiver. If no connection is made, connect directly to the radio and change the port settings. Try to connect through the receiver again to ensure that they are communicating.
	Faulty cable between receiver and radio.	Try a different cable. Examine the ports for missing pins. Use a multimeter to check pinouts.
	No power to radio.	If the radio has its own power supply, check the charge and connections. If power is routed through the receiver, ensure that the receiver's external power source is charged and that power output on Port 3 is enabled.

Table C.2 Receiver issues (continued)

Issue	Possible cause	Solution
Roving receiver is not receiving radio.	Reference receiver is not broadcasting.	See above.
	Incorrect over air baud rates between reference and rover.	Connect to the roving receiver's radio and check to ensure it has the same setting as the reference receiver.
	Incorrect port settings between roving external radio and receiver.	If the radio is receiving data (the Logging/Memory LED is flashing) and the receiver is not getting radio communications, use Trimble Survey Controller to check that the port settings are correct.
	The radio antenna cable and GPS antenna cable are mixed up.	Make sure that the radio antenna cable (with the blue over-mould) is connected between the blue TNC connector marked RADIO and the radio antenna.
	The cellular modem does not have hardware flow control enabled.	<p>Disable flow control on the modem.</p> <p>Use a special cable. For more information, refer to the document <i>Using Cellular and CDPD Modems for RTK</i>, which is available from the Trimble website.</p>

Index

Symbols

- Ⓜ 13, 38
- Ⓞ 13, 38, 125
- \$ (NMEA start of message delimiter) 170
- * (NMEA checksum delimiter) 172
- , (NMEA field delimiter) 170
- .cfg files 55–59, 68, 135–138
- .dat files 66, 68
 - size 65
- .elf files 50, 68, 132
- .eph files 68
- .T01 files 65, 66, 68

Numerics

- 1PPS output
 - configuring in real time 104
 - default settings 85
 - enabling in real time 104
 - pulse definition 102
 - time tag definition 103
 - Trimble R7 receiver 8, 82, 102–103

A

- accuracy
 - centimeter-level 8, 110
 - submeter-level 8, 110

- Actual Track Made Good Over and Speed
 - Over Ground message 186
- adding frequencies for internal radio 74, 144
- ANT port 16, 198
- antenna information, default 86, 159
- Antenna record, in application file 55, 135
- antennas
 - electrical interference 18, 117
 - mounting 18, 117
 - RPA 28
 - rubber duck 22, 28
 - using with the Trimble R7 receiver 97
 - whip 22, 28
 - Zephyr 23
 - Zephyr Geodetic 23
- application file
 - Current.cfg 56
 - Default.cfg 56
 - Power_up.cfg 57
- application files 56, 59
- applying 59, 138
- configuring the receiver with 135
- Current (Current.cfg) 56, 84, 136, 158
- Default (Default.cfg) 56, 84, 136, 158
- Default.cfg 84
- deleting 39, 125
- deleting by formatting CompactFlash card 44
- maximum number 56, 136
- naming 60, 138

- overview 55, 135
- Power Up (Power_Up.cfg) 57, 84, 137, 158
- records 55, 135
- storing 59, 138
- timed 40, 58, 90

applying application files 59, 138

ASCII

- output, default settings 85, 159
- time tags, default 85
- time tags, definition 103

B

backpack setup 28

base station *See* reference station

baseline, moving 170

batteries

- camcorder 33
- charging in reference and rover
 - receiver at the same time 47
- charging while in Trimble R7
 - receiver 46
- charging with TSCe/TSC1
 - batteries 49
- minimum power to charge 46
- operating time 45, 80, 152
- standby 41

battery

- compartments 14, 17, 117
- inserting in the Trimble R8
 - receiver 118
- LEDs 41

baud rate

- default 85, 159
- maximum 82, 154

binary output, default settings 85, 159

blue RPA cable 16, 198

blue TNC port 16, 198

Bluetooth 3

bottom panel 17, 117

bracket

- insert 24
- receiver 24, 25
- RPA 22

breakout box, on event marker/IPPS

- cable 95

buttons 13, 38, 114, 125

C

cables

- coaxial 97
- data/power 63, 94, 164
- event marker/IPPS 95
- GPS antenna 16, 103
- RPA 16

camcorder batteries 33

catch

- for battery compartment 14
- for CompactFlash/USB door 13, 114

cellphones 33, 121

cellular modems 33, 121, 198

centimeter-level accuracy 8, 110

charging

- internal batteries 46
- minimum time required 46
- Trimble R7 and TSC1/TSCe
 - batteries 48

CMR

- input 9, 111
- output 9, 111
- output, default settings 85

coaxial cable, for connecting to GPS

- antenna 97

COCOM limits 10, 112

cold start, time required 82, 154

color-coded TNC ports 16

CompactFlash card

- corrupted 196

- formatting 39, 44, 196
 - full 42
 - logging data to 42
 - transferring files from 66
 - Type I 36
 - upgrading receiver firmware from 50, 132
 - CompactFlash port 17, 117
 - CompactFlash/USB door 17, 117
 - CompactFlash/USB door catch 13, 114
 - configuring
 - 1PPS output in real time 104
 - event marker input in real time 100
 - MS Series parameters 174
 - receiver in real time 54, 134
 - receiver using application files 135
 - connecting to computer for data transfer 63
 - controller
 - mounting on pole 26
 - power supply 48
 - setup 26
 - corrupted CompactFlash card 196
 - Current application file 56, 84, 136, 158
 - current application file 56
 - current receiver configuration 136
 - current settings 158
 - Current.cfg 56, 84, 136, 158
- D**
- DAT files 65, 66
 - data
 - logging internally 42
 - logging to Trimble Survey
 - Controller 43, 128
 - transferring from the receiver 61
 - Data button 13, 38
 - data files
 - deleting by formatting CompactFlash card 44
 - transferring 65
 - transferring from CompactFlash card 66
 - Trimble R7 receiver 66, 68
 - Data LED *See* Logging/Memory LED
 - data link, using a cellular modem 33, 121
 - data outputs, NMEA 174
 - data storage cards *See* CompactFlash cards
 - data transfer
 - transferring files 61–68
 - with serial connection 63
 - with USB connection 64
 - Data Transfer utility
 - deleting files on receiver with 68
 - transferring files with 65
 - data/power cable pinouts 94, 164, 165
 - Default application file 56, 84, 136, 158
 - default application file 56
 - default settings
 - 1PPS time tags 85
 - antenna 86, 159
 - ASCII output 85, 159
 - ASCII time tags 85
 - baud rate 85, 159
 - binary output 85, 159
 - changing 137
 - CMR output 85
 - elevation mask 85, 159
 - factory 87
 - logging rate 86
 - measurement rate 86
 - motion 85, 159
 - NMEA output 85, 159
 - overriding 136
 - Port 3 power output 85
 - position logging rate 86
 - reference position 86, 159
 - reference station 85, 159

- resetting 128
- RT17 output 85, 159
- RTCM output 85
- serial format 85, 159
- SNR mask 85
- streamed output 85, 159
- SV enabling 85, 159
- Trimble R7 receiver 84
- Trimble R8 receiver 158

Default.cfg 56, 84, 136, 158

defining 59

deleting files

- application files 39, 125
- by formatting CompactFlash card 44
- ephemeris file 39, 125
- in the receiver 68

delimiters, NMEA

- checksum 172
- field separator 172
- start of message 170

Device Control record, in application file 55, 135

diameter, of pole 24

dimensions

- Trimble R7 receiver 80
- Trimble R8 receiver 152

direction, NMEA field format 172

disabling flow control 198

dual event marker input 8, 100

dual-frequency RTK engine 8, 110

E

- electrical interference 18, 117
- electronic interference 112
- elevation mask
 - default 85, 159
- enabling
 - 1PPS output in real time 104
 - event marker input in real time 100

- power output on Port 3 49, 131
- enhanced RTK *See* extended RTK
- environmental factors
 - when setting up the receiver 18, 117
- ephemeris file
 - deleting 39, 125
 - supported file type 68
- eRTK Range Pole antenna *See* RPA
- event marker input
 - configuring in real time 100
 - feature 8
- Event Marker LED *See* Radio LED
- event marker/1PPS
 - cable 95
 - cable pinouts 96
- examples, of default behavior 87
- extended RTK 8
- external power 49
 - minimum required to charge internal batteries 46

F

- factory defaults 87
 - resetting to 39, 86, 125, 160
 - Trimble R7 receiver 83–90
 - Trimble R8 receiver 157–160
- FastStatic surveying
 - specifications 81, 153
- features
 - 1PPS output 8
 - automatic OTF (on-the-fly)
 - initialization 8, 110
 - centimeter accuracy 8, 110
 - charging batteries internally 9
 - CMR input and output 9, 111
 - CompactFlash card 9
 - extended RTK 8
 - OTF data 8, 110
 - real-time positioning 8, 110

- RS-232 ports 9
- RTCM SC-104 input and output 9, 111
- RTK data 8, 110
- submeter accuracy 8, 110
- Trimble R8 receiver 110
- USB port 9
- WAAS capability 8, 110
- file size 65
- File Storage record, in application file 55, 135
- file types
 - .cfg 68
 - .dat 66
 - .elf 68
 - .eph 68
 - .T01 66
 - application (.cfg) 68
 - DAT 65
 - data (.dat) 66
 - data files 66
 - ephemeris (.eph) 68
 - job 43, 128
 - raw observations (.T01) 68
 - receiver firmware (.elf) 68
 - supported 68
- files
 - deleting 68
 - transferring from CompactFlash card 66
- firmware
 - (.elf) files 68
 - upgrading 50, 72, 132, 142
- flashing LED 39, 125
- flow control
 - default setting 85, 159
 - disabling on cellular modem 33, 121, 198
 - Trimble R7 receiver 82
 - Trimble R8 receiver 154
 - formatting a CompactFlash card 36, 39, 44
 - frequencies, for internal radio 74, 144
 - front panel 13, 114
 - full format 196
 - full memory 42
 - full reset 196
- G**
 - General Controls record, in application file 55, 135
 - GGA message, time, position, and fix related data 174
 - GPS antenna cable 16
 - GPS antenna port 9, 16, 111, 198
 - GPS Configurator software
 - configuring IPPS output 104
 - configuring event marker input 100
 - configuring Trimble R8 receiver 71, 141
 - deleting files on receiver with 68
 - installing 70, 140
 - performing a full format 196
 - Trimble R7 receiver 43, 70
 - Trimble R8 receiver 120, 134, 140
 - GPS LED *See* SV Tracking LED
 - green LEDs 41
 - GSA message 176
 - GSOF output 82
 - GST message 177
 - GSV message 178
 - guidelines for setting up receiver 19, 118
- H**
 - Heading Information message 184

I

- icons, on top panel 16, 116
- indicator LEDs 13, 39, 114, 125
- initialization
 - minimum time required 82, 154
 - on-the-fly 8, 110
 - specifications 82, 154
- input
 - CMR 9, 111
 - event marker 8, 99
 - RTCM 9, 111
- Input Message record, in application file 55, 135
- insert, for receiver bracket 24
- installing
 - GPS Configurator software 70, 140
 - WinFLASH software 72, 142
- interference
 - electrical 18, 117
 - electronic 112
- internal batteries
 - charging 9
 - charging while in Trimble R7 receiver 46
 - charging with TSC1/TSCe batteries 49
 - minimum power to charge 46
 - operating time 45, 80, 152
 - standby 41
- internal radio
 - adding frequencies 74, 144
 - Trimble R7 receiver 31
 - Trimble R8 receiver 120
- internal transmitter, R8 receiver 30

J

- job files 43, 128

L

- latency
 - Trimble R7 receiver 81
 - Trimble R8 receiver 153
- latitude, NMEA field format 172
- LEDs
 - Battery 1 41
 - Battery 2 41
 - flashing 39, 125
 - Logging/Memory 40
 - Radio 41
 - SV Tracking 40
 - Trimble R7 receiver 13, 39
 - Trimble R8 receiver 114, 125
- Lemo cables, plugging in 19, 118
- limits, imposed by COCOM 10, 112
- Lithium ion batteries, voltage 50
- Lithium-ion battery
 - charging 48
 - disposing of 48
 - safety warning 45
- Local Coordinate Position Output message 182
- logging
 - internally 42
 - scheduling 58
 - starting 39
 - stopping 39
 - to Trimble Survey Controller software 43, 128
- Logging button *See* Data button
- Logging Rate record, in application file 55, 135
- logging rate, default 86
- Logging/Memory LED 40
- longitude, NMEA field format 172
- Low Latency RTK mode, specifications 81, 153

M

maximum

- baud rate 82, 154
- number of application files 56, 136

Maxwell architecture 82, 154

measurement rate, default 86

Memory LED *See* Logging/Memory LED

memory, full 42, 196

message ID, in NMEA messages 172

mobile phones 33, 121

Monitor mode 40, 50, 51, 132, 194

motion, default settings 85, 159

mounting antenna, avoiding electrical interference 18, 117

N

naming application files 60, 138

NMEA

- output 9, 111, 169–187
- output, default settings 85, 159

NMEA messages

- common elements 171
- common message elements 172
- delimiters 172
- enabling and disabling 171
- GGA 175
- GSA 176
- GST 177
- GSV 178
- ID 172
- PTNL,GGK 179
- PTNL,GGK_SYNC 180
- PTNL,PJK 182
- PTNL,PJT 183
- PTNL,VGK 183
- PTNL,VHD 184
- summary 170
- values 172

VTG 186

ZDA 187

O

One Pulse per Second output *See* 1PPS output

on-the-fly (OTF) initialization 8, 110

operating controls 114

operating temperature 17, 80, 152

OTF initialization *See* on-the-fly initialization

output formats

- 1PPS 8, 82, 99
- CMR 9, 111
- GSOFF 82
- NMEA 9, 111, 169
- RT17 82, 85, 155, 159
- RTCM 9, 111
- Trimble R7 receiver 82
- Trimble R8 receiver 155

Output Message record, in application file 55, 135

overriding default settings 136

P

parts of the receiver 12–17

physical specifications 80, 152

pinout information 162

R7 92

pinouts

- data/power cable 94, 164, 165
- event marker/1PPS cable 96
- serial ports 93, 163

pole diameter 24

pole-mounted setup

- pole diameter 24
- Trimble R7 receiver 22

- Trimble R8 receiver 118
 - TSC1/TSCe controller 26
 - Port 1
 - connector pin locations 93
 - default baud rate 85, 159
 - default serial format 85, 159
 - event marker input 100
 - flow control 85, 159
 - icon 16, 116
 - pinout diagram 93, 163
 - pinout functions 93
 - power output 49, 131
 - Port 2
 - 1PPS output 100
 - connector pin locations 93
 - default baud rate 85, 159
 - default serial format 85, 159
 - event marker input 100
 - icon 16, 116
 - pinout diagram 93, 163
 - pinout functions 93
 - Port 3
 - connector pin locations 93
 - default baud rate 85
 - default power output 85
 - default serial format 85
 - flow control 85, 159
 - icon 16
 - pinout diagram 93, 163
 - pinout functions 93
 - power output 49, 50, 131
 - port settings, checking 198
 - Position Error Statistics message 177
 - position logging rate, default 86
 - positioning specifications 81, 153
 - postprocessed setup 20
 - power
 - external 49
 - minimum to charge batteries 46
 - Power button 13, 38, 125
 - power cable, pinouts 94, 164, 165
 - Power LEDs *See* Battery LEDs
 - power output
 - automatically enabling on Port 3 50
 - enabling on Port 3 49, 131
 - on Port 1 49, 131
 - power source 129
 - power supply 46
 - Power Up application file
 - overriding factory defaults with 84, 158
 - Trimble R7 receiver 57
 - Trimble R8 receiver 137
 - power up application file 57
 - power/data ports 15
 - Power_Up.cfg
 - overriding factory defaults with 84, 158
 - Trimble R7 receiver 57
 - Trimble R8 receiver 137
 - powering down the receiver 39, 125
 - powering up the receiver 39, 41, 125, 126
 - problems, troubleshooting 193–194
 - Projection Type message 183
 - PTNL,GGK message 179
 - PTNL,GGK message, Time, Position, Position Type, DOP 178
 - PTNL,GGK_SYNC message 180
 - PTNL,PJK message 182
 - PTNL,PJT message 183
 - PTNL,VGK message 183
 - PTNL,VHD message 184
 - pulse, for 1PPS output 102
- ## Q
- quick format 36, 43, 196

R

- radio antenna port 9, 16, 111, 198
- Radio LED 41
- RADIO port
 - icon 16, 116
 - Trimble R7 receiver 16
 - troubleshooting 198
- radio-modems, using 3
- radios
 - internal 31, 120
 - Trimble R7 receiver 30
 - Trimble R8 receiver 119
 - TRIMMARK 3 30, 120
 - TRIMMARK IIe 30, 120
 - TRIMTALK 450S 30, 120
- Range Pole antenna *See* RPA
- raw observations 68
- real time, configuring receiver in 54, 134
- rear panel 14, 115
- receiver
 - bracket 24, 25
 - catch lock 14, 115
 - changing default settings 137
 - configuring 134
 - connecting to devices 162
 - current configuration 136
 - data files 66
 - firmware files 68
 - resetting 136
- receiver setup 11–36, 113–121
- red LED 40
- Reference Position record, in application file 55, 135
- reference position, default 86, 159
- reference receiver, charging batteries 47
- reference station
 - default settings 85, 159
- reformatting CompactFlash card 44
- registration 2

- release notes 2
- reset
 - full 196
 - soft 196
 - to factory defaults 39, 86, 125, 160
 - Trimble R8 receiver 136
- rover, charging batteries 47
- RPA 28
- RPA bracket 22
- RS-232 ports 9
- RT17 output
 - default settings 85, 159
 - Trimble R7 receiver 82
 - Trimble R8 receiver 155
- RTCM input 9, 111
- RTCM output
 - default settings 85
 - messages 190
 - Trimble R7 receiver 9
 - Trimble R8 receiver 111
- RTK engine 8, 110
- RTK/OTF data 8, 110
- rubber duck antenna 22, 28

S

- safety 4
- Satellite Information message 178
- Satellite LED *See* SV Tracking LED
- scheduling logging sessions 58
- security limits 112
- serial format, default setting 85, 159
- Serial Port Baud/Format record, in application file 55, 135
- serial ports
 - pinouts 93, 164
 - Trimble R7 receiver 8, 9, 15
- setup
 - backpack 28

- guidelines 18, 117
 - pole-mounted 22, 118
 - postprocessed survey 20
 - Trimble R7 receiver 11–36
 - Trimble R8 receiver 113–121
 - TSC1/TSCe controller 26
- signal processing 82, 154
- size
- Trimble R7 receiver 80
 - Trimble R8 receiver 152
- Sleep mode 40, 59, 90
- SNR mask, default setting 85
- soft reset 196
- special application files 56
- specifications
- physical 80, 152
 - positioning 81, 153
 - technical 82, 154
 - Trimble R7 receiver 79–82
 - Trimble R8 receiver 151–155
- standby, battery 41
- starting logging manually 39
- start-up specifications 82, 154
- Static surveying
- specifications 81, 153
- Static/Kinematic record, in application file 55, 135
- stopping logging manually 39
- storage temperature 17, 80, 152
- storing application files 59, 138
- streamed output, default settings 85, 159
- submeter-level accuracy 8, 110
- supported file types 68
- Survey Controller software *See* Trimble Survey Controller software
- SV Enable/Disable record, in application file 55, 135
- SV enabling, default settings 85, 159
- SV Tracking LED 40
- switching the receiver on and off 39, 41, 125, 126
- Synchronized RTK mode, specifications 81, 153

T

- T01 files 67
- technical specifications 82, 154
- temperature
- operating range 17, 80, 152
 - storage range 17, 80, 152
- time tag definition 103
- time values in NMEA messages 173
- Time, Position, and Fix Related Data message 175
- Time, Position, and Fix Related Data, GGA message 174
- Time, Position, Position Type, DOP message 179
- Time, Synchronized Position, Position Type, DOP message 180
- Timed Activation record, in application file 55
- timed application file 58
- timed application files 40, 58, 90
- TNC connector 9, 97, 111
- TNC ports 9, 111
- top panel 15
- tracking specifications 82, 154
- transceiver *See* Trimble R8 internal transmitter
- transferring
- data files from CompactFlash card 66
 - data files from the receiver 61
- Trimble Binary Streamed Output *See* GSOF output
- Trimble Format (CMR) *See* CMR format
- Trimble R7 receiver
- backpack setup 28

- buttons 38
 - factory default settings 84
 - features 8
 - internal radio 31
 - LEDs 39
 - maximum number of application files 56
 - output formats 82
 - parts of the receiver 12–17
 - pole-mounted setup 22
 - postprocessed setup 20
 - resetting to factory defaults 39, 86
 - setup 11–36
 - specifications 79–82
 - turning on and off 39, 41
 - upgrading firmware 50, 72
 - use and care 9
 - Trimble R8 internal transmitter 30
 - Trimble R8 receiver
 - buttons 125
 - factory default settings 158
 - inserting the internal battery 118
 - internal radio 120
 - LEDs 125
 - maximum number of application files 136
 - output formats 155
 - parts of the receiver 114–116
 - pole-mounted setup 118
 - resetting to factory defaults 125, 160
 - setup 113–121
 - specifications 151–155
 - turning on and off 125, 126
 - upgrading firmware 132, 142
 - use and care 112
 - Trimble Survey Controller software
 - automatically enabling power output 50
 - configuring the internal radio with 120
 - configuring the receiver with 134
 - logging data to 43
 - Trimble web site 1, 34, 121
 - TRIMMARK 3 radio 30, 120
 - TRIMMARK IIe radio 30, 120
 - TRIMTALK radio 30, 120
 - troubleshooting 193–194
 - TSC1/TSCe controller
 - deleting files on receiver with 68
 - mounting on pole 26
 - power supply 48
 - setup 26
 - turning the receiver on and off 39, 41, 125, 126
 - Type approval 4
 - Type I CompactFlash cards 9, 36
 - types of files supported 68
- ## U
- U.S. Department of Commerce 10, 112
 - Universal Time Coordinated (UTC) *See* UTC
 - upgrading receiver firmware 50, 72, 132, 142
 - USB cable, connecting for data transfer 64
 - USB port 8, 9, 17, 82, 117
 - use and care of Trimble R7 receiver 9
 - use and care of Trimble R8 receiver 112
 - UTC Day, Month, and Year, and Local Time
 - Zone Offset message 187
 - UTC, NMEA time values 173
- ## V
- Vector Information message 183
 - voltage
 - minimum required to charge internal batteries 46
 - of internal batteries 50

Index

VTG message 186

W

WAAS

- specifications 81, 153

- Trimble R7 receiver 8

- Trimble R8 receiver 110

waking up, from Sleep mode 59

warm start, time required 82, 154

web site 1, 34, 121

weight

- Trimble R7 receiver 80

- Trimble R8 receiver 152

whip antenna 22

WinFLASH software

- installing 72, 142

- Trimble R8 receiver 71, 120, 141

- upgrading receiver firmware with 72,
142

world wide web site 1, 34, 121

Y

yellow GPS antenna cable 16, 198

yellow LEDs 40, 41

yellow TNC port 16, 198

Z

ZDA message 187

Zephyr antenna 23

Zephyr Geodetic antenna 23

Free Manuals Download Website

<http://myh66.com>

<http://usermanuals.us>

<http://www.somanuals.com>

<http://www.4manuals.cc>

<http://www.manual-lib.com>

<http://www.404manual.com>

<http://www.luxmanual.com>

<http://aubethermostatmanual.com>

Golf course search by state

<http://golfingnear.com>

Email search by domain

<http://emailbydomain.com>

Auto manuals search

<http://auto.somanuals.com>

TV manuals search

<http://tv.somanuals.com>