



USER GUIDE

Trimble® SPSx51 Modular GPS Receivers



USER GUIDE

Trimble® SPSx51 Modular GPS Receivers

Version 3.60
Revision A
January 2008



Corporate Office

Trimble Navigation Limited
935 Stewart Drive
Sunnyvale, CA 94085
USA
www.trimble.com

Construction Business Area

Trimble Navigation Limited
Construction Business Area
5475 Kellenburger Road
Dayton, Ohio 45424-1099
USA
800-538-7800 (toll free in USA)
+1-937-245-5600 Phone
+1-937-233-9004 Fax
www.trimble.com
E-mail: trimble_support@trimble.com

Legal Notices

© 2006–2007, Trimble Navigation Limited. All rights reserved.
Trimble, and the Globe & Triangle logo are trademarks of Trimble Navigation Limited, registered in the United States Patent and Trademark Office and in other countries. AutoBase, CMR, CMR+, HYDRO^{pro}, Maxwell, Micro-Centered, TGO, SiteNet, TRIMMARRK, TRIMTALK, TSC2, TSCe, VRS, Zephyr, and Zephyr Geodetic are trademarks of Trimble Navigation Limited.

The Bluetooth word mark and logos are owned by the Bluetooth SIG, Inc. and any use of such marks by Trimble Navigation Limited is under license.

Microsoft, Windows, and Windows NT are either registered trademarks or trademarks of Microsoft Corporation in the United States and/or other countries.

All other trademarks are the property of their respective owners.

Release Notice

This is the January 2008 release (Revision A) of the *SPSx51 Modular GPS Receivers User Guide*. It applies to version 3.60 of the receiver firmware.

Product Limited Warranty Information

For applicable product Limited Warranty information, please refer to the Limited Warranty Card included with this Trimble product, or consult your local Trimble authorized dealer.

Notices

Class B Statement – Notice to Users. This equipment has been tested and found to comply with the limits for a Class B digital device, pursuant to Part 15 of the FCC rules and Part 90. These limits are designed to provide reasonable protection against harmful interference in a residential installation. This equipment generates, uses, and can radiate radio frequency energy and, if not installed and used in accordance with the instructions, may cause harmful interference to radio communication. However, there is no guarantee that interference will not occur in a particular installation. If this equipment does cause harmful interference to radio or television reception, which can be determined by turning the equipment off and on, the user is encouraged to try to correct the interference by one or more of the following measures:

- Reorient or relocate the receiving antenna.
- Increase the separation between the equipment and the receiver.
- Connect the equipment into an outlet on a circuit different from that to which the receiver is connected.
- Consult the dealer or an experienced radio/TV technician for help.

Changes and modifications not expressly approved by the manufacturer or registrant of this equipment can void your authority to operate this equipment under Federal Communications Commission rules.

Canada

This Class B digital apparatus complies with Canadian ICES-003. Cet appareil numérique de la classe B est conforme à la norme NMB-003 du Canada.

This apparatus complies with Canadian RSS-GEN, RSS-310, RSS-210, and RSS-119.

Cet appareil est conforme à la norme CNR-GEN, CNR-310, CNR-210, et CNR-119 du Canada.

Europe

This product (the SPSx51 Modular GPS receiver) is intended to be used in all EU member countries, Norway, and Switzerland.



This product has been tested and found to comply with the requirements for a Class B device pursuant to European Council Directive 89/336/EEC on EMC, thereby satisfying the requirements for CE Marking and sale within the European Economic Area (EEA). Contains Bluetooth radio module PBA 31308. These requirements are designed to provide reasonable protection against harmful interference when the equipment is operated in a residential or commercial environment. The 450 MHz (PMR) bands and 2.4 GHz are non-harmonized throughout Europe.

Australia and New Zealand

This product conforms with the regulatory requirements of the Australian Communications Authority (ACA) EMC framework, thus satisfying the requirements for C-Tick Marking and sale within Australia and New Zealand.



Taiwan – Battery Recycling Requirements

The product contains a removable Lithium-ion battery. Taiwanese regulations require that waste batteries are recycled.



廢電池請回收

Notice to Our European Union Customers

Directive 1999/5/EC

Hereby, Trimble Navigation, declares that the SPSx50 and SPSx51 GPS receivers are in compliance with the essential requirements and other relevant provisions of Directive 1999/5/EC.

Restriction of Use of Certain Hazardous Substances in Electrical and Electronic Equipment (RoHS)

The following statement only applies to the SPSx51 Modular GPS receiver (no internal radio model and 450 MHz internal radio models only)

This Trimble product complies in all material respects with DIRECTIVE 2002/95/EC OF THE EUROPEAN PARLIAMENT AND OF THE COUNCIL of 27 January 2003 on the restriction of the use of certain hazardous substances in electrical and electronic equipment (RoHS Directive) and Amendment 2005/618/EC filed under C(2005) 3143, with exemptions for lead in solder pursuant to Paragraph 7 of the Annex to the RoHS Directive applied.

Waste Electrical and Electronic Equipment (WEEE)

For product recycling instructions and more information, please go to www.trimble.com/ev.shtml.

Recycling in Europe: To recycle Trimble WEEE (Waste Electrical and Electronic Equipment, products that run on electrical power.), Call +31 497 53 24 30, and ask for the "WEEE Associate". Or, mail a request for recycling instructions to:



Trimble Europe BV
c/o Menlo Worldwide Logistics
Meerheide 45
5521 DZ Eersel, NL

Declaration of Conformity

We, Trimble Navigation Limited,

935 Stewart Drive
PO Box 3642
Sunnyvale, CA 94088-3642
United States
+1-408-481-8000

declare under sole responsibility that the products:
SPSx51 Modular GPS receiver
comply with Part 15 of FCC Rules.

Operation is subject to the following two conditions:
(1) this device may not cause harmful interference, and
(2) this device must accept any interference received, including interference that may cause undesired operation.

Safety Information

Before you use your Trimble® SPS GPS receiver, make sure that you have read and understood all safety requirements.

Regulations and safety

The receivers contain an internal radio-modem and can send signals through Bluetooth® wireless technology or through an external data communications radio. Regulations regarding the use of the 450 MHz radio-modems vary greatly from country to country. In some countries, the unit can be used without obtaining an end-user license. Other countries require end-user licensing. For licensing information, consult your local Trimble dealer. Bluetooth and 900 MHz radio-modems operate in license-free bands.

Before operating an SPSx51 Modular GPS receiver, determine if authorization or a license to operate the unit is required in your country. It is the responsibility of the end user to obtain an operator's permit or license for the receiver for the location or country of use.

For FCC regulations, see [Notices, page 2](#).

Type approval

Type approval, or acceptance, covers technical parameters of the equipment related to emissions that can cause interference. Type approval is granted to the manufacturer of the transmission equipment, independent from the operation or licensing of the units. Some countries have unique technical requirements for operation in particular radio-modem frequency bands. To comply with those requirements, Trimble may have modified your equipment to be granted Type approval. Unauthorized modification of the units voids the Type approval, the warranty, and the operational license of the equipment.

Exposure to radio frequency radiation

For 450 MHz radio

Safety. Exposure to RF energy is an important safety consideration. The FCC has adopted a safety standard for human exposure to radio frequency electromagnetic energy emitted by FCC regulated equipment as a result of its actions in General Docket 79-144 on March 13, 1986.

Proper use of this radio modem results in exposure below government limits. The following precautions are recommended:

- **DO NOT** operate the transmitter when someone is within 20 cm (7.8 inches) of the antenna.
- **DO NOT** operate the transmitter unless all RF connectors are secure and any open connectors are properly terminated.
- **DO NOT** operate the equipment near electrical blasting caps or in an explosive atmosphere.

- All equipment must be properly grounded according to Trimble installation instructions for safe operation.
- All equipment should be serviced only by a qualified technician.

For license-free 900 MHz radio¹



CAUTION – For your own safety, and in terms of the RF exposure requirements of the FCC, always observe the precautions listed here.

- **DO NOT** operate the transmitter when someone is within 20 cm (7.8 inches) of the antenna.
- Do not co-locate the antenna with any other transmitting device.

For Bluetooth radio

The radiated output power of the internal Bluetooth wireless radio is far below the FCC radio frequency exposure limits. Nevertheless, the wireless radio shall be used in such a manner that the Trimble receiver is 20 cm or further from the human body. The internal wireless radio operates within guidelines found in radio frequency safety standards and recommendations, which reflect the consensus of the scientific community. Trimble therefore believes that the internal wireless radio is safe for use by consumers. The level of energy emitted is far less than the electromagnetic energy emitted by wireless devices such as mobile phones. However, the use of wireless radios may be restricted in some situations or environments, such as on aircraft. If you are unsure of restrictions, you are encouraged to ask for authorization before turning on the wireless radio.

Installing antennas



CAUTION – For your own safety, and in terms of the RF exposure requirements of the FCC, always observe these precautions:

- Always maintain a minimum separation distance of 20 cm (7.8 inches) between yourself and the radiating antenna.
 - Do not co-locate the antenna with any other transmitting device.
-

This device has been designed to operate with the antennas listed below. Antennas not included in this list are strictly prohibited for use with this device. The required antenna impedance is 50 ohms.

The antennas that can be used (country dependent) with the **450 MHz radio** are 0 dBi and 5 dBi whip antennas. The antennas that can be used (country dependent) with the **900 MHz radio** are 0 dBi, 3 dBi, and 5 dBi whip antennas.

To reduce potential radio interference to other users, the antenna type and its gain should be so chosen so that the equivalent isotropically radiated power (e.i.r.p.) is not more than that permitted for successful communication.

¹ 900 MHz radios are not used in Europe.

Battery safety



WARNING – Do not damage the rechargeable Lithium-ion battery. A damaged battery can cause an explosion or fire, and can result in personal injury and/or property damage.

To prevent injury or damage:

- Do not use or charge the battery if it appears to be damaged. Signs of damage include, but are not limited to, discoloration, warping, and leaking battery fluid.
 - Do not expose the battery to fire, high temperature, or direct sunlight.
 - Do not immerse the battery in water.
 - Do not use or store the battery inside a vehicle during hot weather.
 - Do not drop or puncture the battery.
 - Do not open the battery or short-circuit its contacts.
-



WARNING – Avoid contact with the rechargeable Lithium-ion battery if it appears to be leaking. Battery fluid is corrosive, and contact with it can result in personal injury and/or property damage.

To prevent injury or damage:

- If the battery leaks, avoid contact with the battery fluid.
 - If battery fluid gets into your eyes, immediately rinse your eyes with clean water and seek medical attention. Do not rub your eyes!
 - If battery fluid gets onto your skin or clothing, immediately use clean water to wash off the battery fluid.
-



WARNING – Charge and use the rechargeable Lithium-ion battery only in strict accordance with the instructions. Charging or using the battery in unauthorized equipment can cause an explosion or fire, and can result in personal injury and/or equipment damage.

To prevent injury or damage:

- Do not charge or use the battery if it appears to be damaged or leaking.
 - Charge the Lithium-ion battery only in a Trimble product that is specified to charge it. Be sure to follow all instructions that are provided with the battery charger.
 - Discontinue charging a battery that gives off extreme heat or a burning odor.
 - Use the battery only in Trimble equipment that is specified to use it.
 - Use the battery only for its intended use and according to the instructions in the product documentation.
-

Contents

	Safety Information	3
	Regulations and safety	3
	Type approval	3
	Exposure to radio frequency radiation	3
	For 450 MHz radio	3
	For license-free 900 MHz radio	4
	For Bluetooth radio	4
	Installing antennas	4
	Battery safety.	5
1	Introduction	13
	About the SPSx51 receivers	13
	SPS551 GPS receiver	13
	SPS551H GPS receiver	13
	SPS651 Location GPS receiver with precise vertical accuracy	13
	SPS751 GPS receiver	14
	SPS851 GPS receiver	14
	Related information	14
	Technical support.	14
	Your comments	14
2	Features and Functions	15
	SPS551 features	16
	SPS551 Receiver optional features	17
	SPS551H features	17
	SPS651 features	17
	SPS651 Receiver optional features	19
	SPS751 features	19
	SPS751 <i>standard</i> features	19
	SPS751 Basic	20
	SPS751 Max	21
	SPS851 features	21
	Base station	22
	Rover	22
	Use and care	23
	COCOM limits	23
	Keypad and display	24
	Rear connectors	25
3	Batteries and Power	27
	External power	28
	Battery safety.	28

Battery performance	28
Charging the Lithium-ion battery	29
Storing the Lithium-ion battery	29
Using the Lithium-ion battery as a Universal Power Supply (UPS)	30
Removing the rechargeable Lithium-ion battery	30
4 Setup Guidelines	31
Base station operation guidelines	32
Base station components	32
Base station setup guidelines	33
Permanent installation antenna cabling for the SPSx51 Modular GPS receiver	35
Rover operation guidelines	35
Rover receiver components	36
Rover receiver setup guidelines	37
5 Setting up the Receiver	41
Connecting the receiver to external devices	42
Trimble controller with SCS900 Site Controller software	42
External radio-modems	42
Common ways to set up a base station	43
Setting up a base station for permanent or semi-permanent installation	43
Setting up a base station for daily site use: T-Bar	45
Setting up a mobile base station: Tripod and fixed height tripod	46
Common ways to set up a rover receiver	48
Setting up the rover receiver on a jobsite vehicle	49
Setting up the rover receiver on a rod	50
Setting up a rover receiver on a belt or in a backpack	51
Setting up a pair of GPS receivers to provide heading	51
The Moving Baseline RTK positioning technique	52
Mounting a pair of GPS receivers	53
Assembling the receivers	54
Installing the receiver	58
Mounting the antennas	58
Configuring the receiver pair	58
Interfacing using the NMEA protocol	59
Heading output	59
6 Configuring the Receiver Using the Keypad and Display	61
Button functions	62
Power button operations	62
Home screen	63
Status screens	63
Configuring the receiver as a base receiver	64
Configuring the receiver	64
Configuring the receiver as a rover receiver	66

Configuring the receiver	66
Configuring system settings	68
Turning off AutoBase technology.	69
Managing application files	70
7 Configuring the Receiver Settings	71
Using the SCS900 Site Controller software to configure the base station, the rover, and the radios	72
Configuring the receiver to log data for postprocessing	73
Configuring the receiver to use specific settings when it is turned on	73
Configuring Ethernet settings	74
Configuring the receiver using a web browser	77
Supported browsers	77
Connecting to the receiver using a web browser:.	77
Connecting to the receiver using a web browser and Bluetooth wireless technology	78
Creating a new connection.	82
Menus	86
Changing the settings	86
8 Automatically Setting up a Mobile Base Station Using AutoBase Technology	99
AutoBase Warning	100
Working with AutoBase technology	100
Scenario One: First visit to a site with AutoBase Warning turned off	100
Scenario Two: First visit to a site with AutoBase Warning turned on	101
Scenario Three: Repeat visit to a site with AutoBase Warning turned off.	101
Scenario Four: Repeat visit to a site with AutoBase Warning turned on	102
The AutoBase process	103
9 Default Settings	105
Default receiver settings	106
Resetting the receiver to factory defaults	106
Data Logging option	106
Logging data after a power loss	107
10 Specifications.	109
General specifications	110
Physical specifications	110
Performance specifications.	111
Electrical specifications	112
Communication specifications	113
GPS satellite signal tracking	114
Integrated radio options.	114
Variable configuration options.	115
Upgrading the receiver	115

A	NMEA-0183 Output	117
	NMEA-0183 message overview118
	Common message elements119
	Message values119
	NMEA messages119
B	GSOF Messages	135
	Supported message types136
	General Serial Output Format136
	Reading binary values137
	INTEGER data types137
	GSOF message definitions139
	TIME140
	LLH140
	ECEF141
	ECEF DELTA141
	NEU DELTA141
	Velocity142
	PDOP143
	SIGMA143
	SV Brief144
	SV Detail144
	UTC145
	Batt/Mem146
	Attitude146
	BASE POSITION AND QUALITY INDICATOR147
	Flags148
C	Adding Internal Radio Frequencies	151
	Adding receive frequencies for the 450 MHz internal radio.152
	Setting UHF reception radio frequencies using the web interface.153
D	Transmitting Corrections	155
	Scenario 1: Outputting corrections using an HPB450 radio-modem156
	Solution156
	Scenario 2: Outputting corrections using a TRIMMARK 3 radio.157
	Solution157
	Scenario 3: Outputting corrections from a SNB900 radio to an HPB450 or TRIMMARK 3 radio158
	Solution158
E	Real-Time Data and Services	159
	RT17 Streamed Data service160
	Using the keypad and display to configure RT17 outputs.160
	Using the web interface to configure RT17 outputs160

	Login authentication	160
F	Upgrading the Receiver Firmware	161
	The WinFlash utility	162
	Installing the WinFlash utility	162
	Upgrading the receiver firmware	162
	Forcing the receiver into Monitor mode	163
G	Troubleshooting	165
	Receiver issues	166
H	Drawings	169
	Back view	170
	Side view	170
	Bottom view	171
I	Receiver Connector Pinout Information.	173
	Lemo connector	174
	Modem multi-function port	175
	1PPS and ASCII time tag	176
	ASCII time tag	177
	26-Pin D-sub connector wiring chart (P/N 60789-00)	178
	Glossary	179

Introduction

Welcome to the SPSx51 Modular GPS Receivers User Guide. This manual describes how to set up and use the Trimble® SPSx51 Modular GPS receivers.

About the SPSx51 receivers

The SPSx51 Modular GPS receiver family comprises the following receivers:

- SPS551
- SPS551H
- SPS651
- SPS751 Basic base
- SPS751 Basic rover
- SPS751 Max
- SPS851

SPS551 GPS receiver

The Trimble SPS551 is a dual-frequency Location GPS receiver, which provides up to decimeter accuracy depending on the augmentation used. The SPS551 provides decimeter precision when used in Location RTK mode with RTK corrections through the internal radio or Internet. The SPS551 can operate as a DGPS reference station or as a DGPS rover receiver, and can use Satellite Based Augmentation Systems (SBAS). The receiver can also function as a rover receiver that uses OmniSTAR XP, HP, or VBS

correction services. The SPS551 is ideal for mobile applications on marine vessels and site vehicles where Real-Time Kinematic (RTK) accuracy is not needed. The SPS551 can be used with the SPS551H GPS receiver to provide both position and precise heading solutions for marine applications. The SPS551 can be upgraded to use GLONASS signals and to use GPS L2C signals.

SPS551H GPS receiver

The Trimble SPS551H is an add-on receiver that can be combined with the SPS551, SPS751 Max, or SPS851 Extreme to provide a precise heading capability using Trimble moving base technology.

The SPS551H is also available with GLONASS to provide a robust heading solution in a hostile environment.

SPS651 Location GPS receiver with precise vertical accuracy

The SPS651 is a Location GPS receiver with precise vertical and decimeter horizontal positioning. The receiver is part of the vehicle-mounted Trimble Site Supervisor System and used with the SCS900 Site Controller Software Tablet Edition it is designed to provide site supervisors with cost-effective real-time positioning information.

The SPS651 can operate in all Location GPS modes including SBAS, DGPS, OmniSTAR (VBS/HP/XP services), and Location RTK mode. It can be upgraded to use GLONASS signals and to use GPS L2C signals.

SPS751 GPS receiver

The Trimble SPS751 is a dual-frequency GPS receiver with the ability to receive OmniSTAR corrections. The receiver is available in the following configurations:

- SPS751 Basic base
- SPS751 Basic rover
- SPS751 Max

The SPS751 can be configured using the keypad and display, a web browser, or the Trimble SCS900 Site Controller software. The SPS751 makes it easy to set up a mobile base station or a permanent base station for continuous operation. The SPS751 is also an ideal mobile receiver for semi-permanent mounting on vehicles and marine vessels.

SPS851 GPS receiver

The Trimble SPS851 is a triple-frequency GPS plus GLONASS receiver with the ability to receive OmniSTAR corrections. The SPS851 can operate as a base station or rover. The receiver can be configured using the keypad and display, web browser, or Trimble SCS900 Site Controller software. The SPS851 makes it easy to set up a mobile base station or a permanent base station for continuous operation. The SPS851 is also an ideal mobile receiver for semi-permanent mounting on vehicles and marine vessels.

Related information

Sources of related information include the following:

- Release notes – The release notes describe new features of the product, information not included in the manuals, and any changes to the manuals. They are provided as a .pdf file on the *Trimble SPS GPS Receiver CD* or you can download them from the Trimble website (www.trimble.com/support.shtml).

- Trimble training courses – Consider a training course to help you use your GPS system to its fullest potential. For more information, go to the Trimble website at www.trimble.com/training.html.

Technical support

If you have a problem and cannot find the information you need in the product documentation, contact your local dealer. Alternatively, go to the Support area of the Trimble website (www.trimble.com/support.shtml). Select the product you need information on. Product updates, documentation, and any support issues are available for download.

If you need to contact Trimble technical support, complete the online inquiry form at www.trimble.com/support_form.asp.

Your comments

Your feedback about the supporting documentation helps us to improve it with each revision. Email your comments to ReaderFeedback@trimble.com.

Features and Functions

In this chapter:

- SPS551 features
- SPS551H features
- SPS651 features
- SPS751 features
- SPS851 features
- Use and care
- COCOM limits
- Keypad and display
- Rear connectors

Trimble SPSx51 Modular GPS receivers are ideal for the following infrastructure development, site development, and marine construction applications:

- Mobile base station for RTK or DGPS applications
- Permanent base station RTK or DGPS applications (not available in the SPS551H)
- RTK rover on rod, backpack, site vehicle, or marine vessel
- Site and marine location applications using Location GPS augmentation including OmniSTAR, Location RTK, SBAS, and DGPS RTCM

You can use the receivers with the Trimble SCS900 Site Controller software.

These receivers all feature a keypad and display so you can configure the receiver without using a controller or computer.

All the receivers can record GPS data to the internal memory, and transfer the data over a serial or Ethernet connection.

SPS551 features

The receiver provides the following features:

- Integrated GPS receiver and radio
- Location RTK capable – Location RTK precision of 10 cm horizontal and 10 cm vertical
- Not upgradable to full RTK (SPS751 or SPS851)
- Optional 450 or 900 MHz internal radio
- 72-channel L1 C/A Code, L1/L2 Full Cycle Carrier. Upgradable to L2C and GLONASS L1/L2 Full Cycle Carrier
- OmniSTAR XP/HP/VBS service capable
- 4-channel WAAS (Wide Area Augmentation System), EGNOS (European Geo-Stationary Navigation System), and MSAS Satellite Based Augmentation (SBAS) compatible
- Long-life integrated battery, typically provides 12 hours as a rover with internal radio
- Configuration and monitoring interface through the following methods:
 - Web interface
 - Networked or peer-to-peer Ethernet
 - Integrated display and keyboard
 - Trimble SCS900 Site Controller Software Tablet Edition
- Integrated Bluetooth wireless technology for cable-free configuration and operation with a laptop or controller
- Attached or external radio antenna for rover operation
- Small, lightweight design – 1.65 kg (3.64 lbs) receiver only, including the battery; 4 kg (8.82 lbs) complete system weight (rover including controller and rod)
- Vehicle and marine vessel mounting options for Supervisor and Dredging applications
- Easy-to-use menu system for rapid configuration and status checking
- Rugged, weatherproof construction with an IP67 environmental rating
- $-40\text{ }^{\circ}\text{C}$ to $+65\text{ }^{\circ}\text{C}$ ($-40\text{ }^{\circ}\text{F}$ to $+149\text{ }^{\circ}\text{F}$) operating temperature range
- 9.5 V to 28 V DC input power range, with over-voltage protection
- Capable of rover operation within a VRS (Virtual Reference Station) network
- Moving baseline and heading capability when combined with an appropriate SPSx51, SPSx50, or SPS551H receiver
- RoHS compliant

- Can be upgraded to receive GLONASS signals.

Note – When the receiver is upgraded to GLONASS, the GA510 rover GPS antenna should be replaced with the Zephyr™ Model 2 antenna.

- 1 Pulse-per-second (1PPS) output

SPS551 Receiver optional features

- Internal 450 MHz (3 frequency bands) radio with transmit and receive capability
- Internal 900 MHz radio with transmit and receive capability

SPS551H features

The SPS551H receiver is an add-on receiver, which provides Precise GPS heading capability when combined with another SPSx51 Modular GPS receiver (excluding the SPS751 Basic base and or another SPS551H receiver). The SPS551H cannot be used alone.

The SPS551H receiver provides the following features:

- Low-cost Precise GPS Heading add-on GPS receiver for the Trimble SPS551, SPS751, or SPS851 receivers
- Connection to another GPS receiver through Bluetooth wireless technology or a serial port
- 10 Hz heading update rate in NMEA 0183 and Trimble binary formats
- Configuration and heading on a two-line display
- Includes a GA510 rover or Zephyr Model 2 rover GPS antenna, mounting bracket, and short interconnecting cable
- RoHS compliant
- Tracks up to 24 GPS satellites
- Can be upgraded to receive GLONASS signals
- 1 Pulse-per-second (1PPS) output

The receiver is ideal for projects that require the precise heading of a vessel or structure.

SPS651 features

The receiver provides the following features:

- Integrated GPS receiver and radio
- Precise Vertical measurement when in Location RTK mode – Location RTK precision of 10 cm horizontal and 2 cm vertical

- Not upgradable to full RTK (SPS751 or SPS851)
- Optional 450 or 900 MHz internal radio
- 72-channel L1 C/A Code, L1/L2 Full Cycle Carrier. Upgradable to L2C and GLONASS L1/L2 Full Cycle Carrier
- OmniSTAR XP/HP/VBS service capable
- 4-channel WAAS (Wide Area Augmentation System), EGNOS (European Geo-Stationary Navigation System), and MSAS Satellite Based Augmentation (SBAS) compatible
- Long-life integrated battery, typically provides 12 hours as a rover with internal radio
- Configuration and monitoring interface through the following methods:
 - Web interface
 - Networked or peer-to-peer Ethernet
 - Integrated display and keyboard
 - Trimble SCS900 Site Controller Software Tablet Edition
- Integrated Bluetooth wireless technology for cable-free configuration and operation with a laptop or controller
- Attached or external radio antenna for rover operation
- Small, lightweight design – 1.65 kg (3.64 lbs) receiver only, including the battery; 4 kg (8.82 lbs) complete system weight (rover including controller and rod)
- Vehicle and marine vessel mounting options for Supervisor and Dredging applications
- Easy-to-use menu system for rapid configuration and status checking
- Rugged, weatherproof construction with an IP67 environmental rating
- -40 °C to +65 °C (-40 °F to +149 °F) operating temperature range
- 9.5 V to 28 V DC input power range, with over-voltage protection
- Capable of rover operation within a VRS (Virtual Reference Station) network
- Moving baseline and heading capability when combined with an appropriate SPSx51, SPSx50, or SPS551H receiver
- RoHS compliant

SPS651 Receiver optional features

- Internal 450 MHz (3 frequency bands) radio with receive capability
- Internal 900 MHz radio with transmit and receive capability
- Can be upgraded to receive GLONASS signals
- Can be upgraded to receive L2C signals

Note – When the receiver is upgraded to GLONASS, the GA510 rover GPS antenna should be replaced with the Zephyr™ Model 2 antenna.

This receiver is ideal for site supervisors on construction and roading projects or marine dredging

SPS751 features

The SPS751 receiver provides the following standard features. For features specific to each model, see below.

SPS751 standard features

- Integrated GPS receiver and radio
- 450 or 900 MHz radio
- L1/L2/L2C GPS receiver
- OmniSTAR XP/HP/VBS service capable
- WAAS (Wide Area Augmentation System), EGNOS (European Geo-Stationary Navigation System), and MSAS Satellite Based Augmentation (SBAS) compatible
- Long-life integrated battery, typically provides 10 hours operation as a base station with internal transmit/receive radio, or 13 hours as a rover
- Configuration and monitoring interface through the following methods:
 - Web interface
 - Networked or peer-to-peer Ethernet
 - Integrated display and keyboard
 - Trimble SCS900 Site Controller software
- Integrated Bluetooth wireless technology for cable-free configuration and operation with a controller
- Choice of external GPS antenna for base station or rover operation
- Attached or external radio antenna for rover or high-gain base station radio operation

- Small, lightweight design – 1.65 kg (3.64 lbs) receiver only including the battery; 4 kg (8.82 lbs) complete system weight (rover including controller and rod)
- Permanent/semi-permanent and mobile quick setup base station capability
- Backpack, belt, rod, truck, and marine vessel mounting options for rover applications
- Capable of all site measurement and stakeout operations within 2.4 km (1.5 m) (SPS751 Basic) and typically 5 km (3.1 m) (SPS751 Max)
- Easy-to-use menu system for rapid configuration and status checking
- AutoBase™ technology for rapid and automated repeated daily base station setups
- Can broadcast corrections through multiple radio links from one base station, for example, through an internal 450 MHz radio and an external 900 MHz radio
- CAN (Controller Area Network) support
- Rugged, weatherproof construction with an IP67 environmental rating
- -40 °C to +65 °C (-40 °F to +149 °F) operating temperature range
- 9.5 V to 28 V DC input power range, with over-voltage protection
- RoHS compliant
- Tracks up to 24 GPS satellites and 4 SBAS satellites
- Can receive GPS L2C signals
- 1 Pulse-per-second (1PPS) output

SPS751 Basic

- Base station only, or rover only, operation

SPS751 Basic base

- Entry-level, low-cost RTK base station
- Unrestricted operational range for rovers and grade control systems
- Integrated transmit-only radio
- Easily upgraded to the SPS751 Max (if the SPS751 Basic base receiver is already fitted with an internal UHF radio, the upgrade includes the ability for the SPS751 Max to receive signals).

SPS751 Basic rover

- Entry-level, low cost RTK rover receiver
- 2 Hz measurement update rate
- 2.4 km (1.5 mile) operational range from the base station

- Integrated receive-only radio
- Easily upgraded to the SPS751 Max (if the SPS751 Basic rover receiver is already fitted with an internal UHF radio, the upgrade includes the ability for the SPS751 Max to transmit signals)

This receiver is ideal for contractors new to GPS as a starter system or for operating multiple small projects.

SPS751 Max

- RTK base station and rover operation in a single receiver
- Integrated receive/transmit radio
- 5 Hz or 10 Hz measurement update rate
- Unrestricted rover operation range from a base station
- Operates within a Trimble VRS network, for base station-free rover capability
- Moving baseline and heading capability when any SPSx51 receiver (excluding the SPS551H or SPS751 Basic receiver) is combined with any SPSx51 or SPS551H add-on receiver.

SPS851 features

The SPS851 receiver provides the following features:

- Integrated GPS receiver and radio
- 450 or 900 MHz radio
- 72-channel L1/L2/L2C/L5 GPS plus L1/L2 GLONASS receiver
- OmniSTAR XP/HP/VBS service capable
- 4-channel WAAS (Wide Area Augmentation System), EGNOS (European Geo-Stationary Navigation System), and MSAS Satellite Based Augmentation (SBAS) compatible
- Long-life integrated battery, typically provides 9 hours operation as a base station or 12 hours as a rover with internal transmit/receive radio
- Configuration and monitoring interface through the following methods:
 - Web interface
 - Networked or peer-to-peer Ethernet
 - Integrated display and keyboard
 - Trimble SCS900 Site Controller software
- Integrated Bluetooth wireless technology for cable-free configuration and operation with a controller

- Choice of external GPS antenna for base station or rover operation
- Attached or external radio antenna for rover or high-gain base station operation
- Small, lightweight design – 1.65 kg (3.64 lbs) receiver only, including the battery; 4 kg (8.82 lbs) complete system weight (rover including controller and rod)
- Permanent/semi-permanent and mobile quick setup base station capability
- Backpack, belt, rod, truck, and marine vessel mounting options for rover applications
- Capable of all site measurement and stakeout operations within radio or cellular coverage
- Easy-to-use menu system for rapid configuration and status checking
- AutoBase technology for rapid and automated repeated daily base station setups
- Can broadcast corrections through multiple radio links from one base station, for example, through an internal 450 MHz radio and an external 900 MHz radio or over the Internet.
- Rugged, weatherproof construction with an IP67 environmental rating
- $-40\text{ }^{\circ}\text{C}$ to $+65\text{ }^{\circ}\text{C}$ ($-40\text{ }^{\circ}\text{F}$ to $+149\text{ }^{\circ}\text{F}$) operating temperature range
- 9.5 V to 28 V DC input power range, with over-voltage protection
- Capable of rover operation within a VRS (Virtual Reference Station) network
- Moving baseline and heading capability when any SPSx51 receiver (excluding the SPS551H or SPS751 Basic receiver) is combined with any SPSx51 or SPS551H Add-on receiver.
- RoHS compliant
- 1 Pulse-per-second (1PPS) output

Note – To receive GPS L5 or GLONASS signals in the SPS851, you must purchase the optional upgrade.

Base station

- Unrestricted operational range for rovers and grade control systems
- Base station and rover operation in a single receiver
- Integrated transmit/receive radio

Rover

- 5 Hz, 10 Hz, or 20 Hz measurement update rate (10 Hz maximum in Heading mode)
- Base station-free rover capability within a VRS network
- Base station-free rover capability using OmniSTAR services

- Operates as an SBAS rover when coverage is available

This receiver is ideal for contractors who operate mid-to-large size projects with machine control.

Use and care

This product is designed to withstand the rough treatment and tough environment that typically occurs in construction applications. However, the receiver is a high-precision electronic instrument and should be treated with reasonable care.



CAUTION – Operating or storing the receiver outside the specified temperature range can damage it. For more information, see [Chapter 10, Specifications](#).

COCOM limits

The U.S. Department of Commerce requires that all exportable GPS products contain performance limitations so that they cannot be used in a manner that could threaten the security of the United States. The following limitations are implemented on this product:

- Immediate access to satellite measurements and navigation results is disabled when the receiver velocity is computed to be greater than 1,000 knots, or its altitude is computed to be above 18,000 meters. The receiver GPS subsystem resets until the COCOM situation clears. As a result, all logging and stream configurations stop until the GPS subsystem is cleared.

Keypad and display

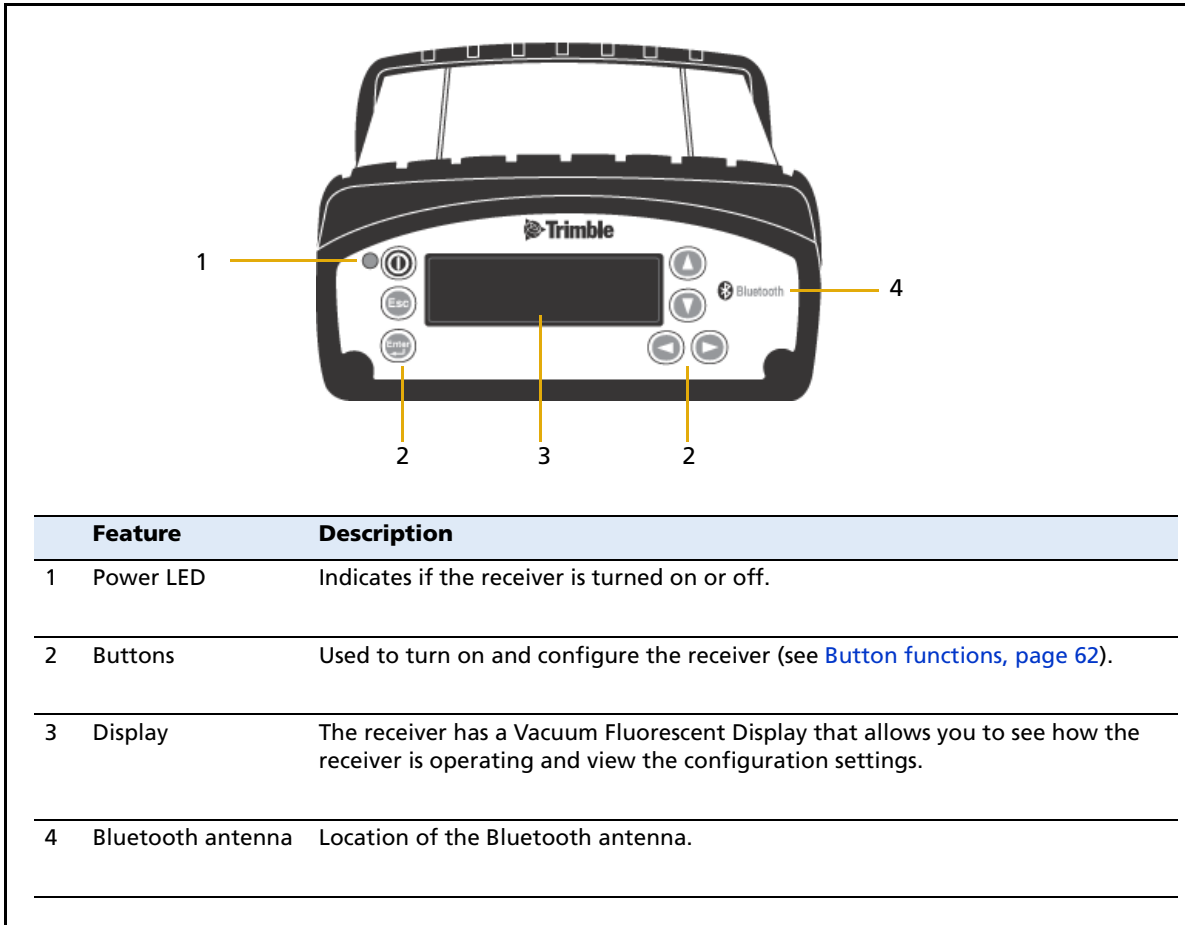

Figure 2.1 Front view of the receiver

Rear connectors

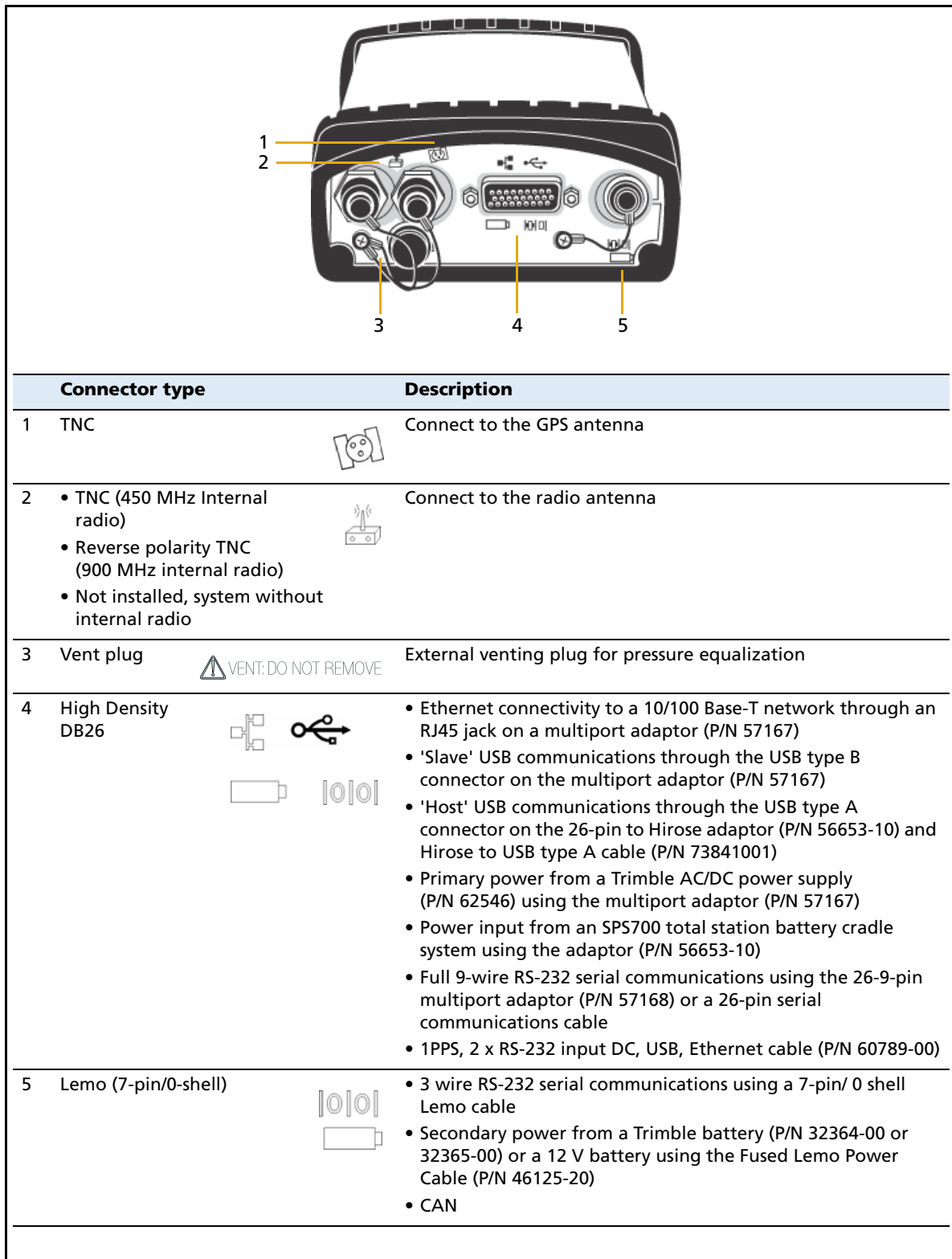

Figure 2.2 Rear view of the receiver

Batteries and Power

In this chapter:

- External power
- Battery safety
- Battery performance
- Charging the Lithium-ion battery
- Storing the Lithium-ion battery
- Using the Lithium-ion battery as a Universal Power Supply (UPS)
- Removing the rechargeable Lithium-ion battery

The GPS receiver uses an internal rechargeable Lithium-ion battery, which can be replaced only at an Authorized Trimble Service Center.

The receiver can also be powered by an external power source that is connected to the Lemo or modem port.

The operational time provided by the internal battery depends on the type of measurement and operating conditions. Typically, the internal battery provides 10 hours operation as a base station and 12 hours as a rover during measurement operations using the internal radio.

***Note** – All battery operation tests are carried out with new, fully charged batteries at room temperature and full receiver configuration operational. Older batteries, at temperatures significantly higher or lower than room temperature, will have a reduced performance. Receivers operating with reduced configuration will have a higher performance.*

External power

The GPS receiver uses an external power source in preference to its internal batteries. If the receiver is not connected to an external power source, or if the external power supply fails, the internal batteries are used.

While carrying out static measurements for postprocessed computations using the internal memory, if no external power is supplied and the internal battery is drained, the receiver shuts down. No data is lost and when power is restored, the receiver restarts in the same status as it was when power was lost.

It is possible to turn off the internal battery using the web interface. In this case, when external power is switched off, there is a limited time (30 seconds) before the unit turns off.

Battery safety

The receiver is powered by a rechargeable internal Lithium-ion battery. Charge and use the battery only in strict accordance with the instructions below.



WARNING – Do not damage the rechargeable Lithium-ion battery. A damaged battery can cause an explosion or fire, and can result in personal injury and/or property damage. To prevent injury or damage:

- Do not use or charge the battery if it appears to be damaged. Signs of damage include, but are not limited to, discoloration, warping, and leaking battery fluid.
 - Do not expose the battery to fire, high temperature, or direct sunlight.
 - Do not immerse the battery in water.
 - Do not use or store the battery inside a vehicle during hot weather.
 - Do not drop or puncture the battery.
 - Do not open the battery or short-circuit its contacts.
-



WARNING – Avoid contact with the rechargeable Lithium-ion battery if it appears to be leaking. Battery fluid is corrosive, and contact with it can result in personal injury and/or property damage.

To prevent injury or damage:

- If the battery leaks, avoid contact with the battery fluid.
 - If battery fluid gets into your eyes, immediately rinse your eyes with clean water and seek medical attention. Do not rub your eyes!
 - If battery fluid gets onto your skin or clothing, immediately use clean water to wash off the battery fluid.
-

Battery performance

To optimize battery performance and extend battery life:

- Fully charge all new batteries before use.
- Batteries perform best when they are not used at extreme temperatures. The receiver is designed to operate at $-40\text{ }^{\circ}\text{C}$ to $+65\text{ }^{\circ}\text{C}$ ($-40\text{ }^{\circ}\text{F}$ to $+149\text{ }^{\circ}\text{F}$). However, operation at temperatures of less than $0\text{ }^{\circ}\text{C}$ ($32\text{ }^{\circ}\text{F}$) can cause a rapid drop in battery life.

- The Lithium-ion batteries are rated to operate from -20°C to $+60^{\circ}\text{C}$ (-4°F to $+140^{\circ}\text{F}$)
- Do not allow a battery that is in storage to discharge to below 5 V.

Charging the Lithium-ion battery

The rechargeable Lithium-ion battery is supplied partially charged. Charge the battery completely before using it for the first time. If the battery has been stored for longer than three months, charge it before use.

The internal battery charges fully in 8 hours when connected to a suitable power source.



WARNING – Charge and use the rechargeable Lithium-ion battery only in strict accordance with the instructions. Charging or using the battery in unauthorized equipment can cause an explosion or fire, and can result in personal injury and/or equipment damage.

To prevent injury or damage:

- Do not charge or use the battery if it appears to be damaged or leaking.
 - Charge the Lithium-ion battery only with a Trimble product that is specified to charge it. Be sure to follow all instructions that are provided with the battery charger.
 - Discontinue charging a battery that gives off extreme heat or a burning odor.
 - Use the battery only in Trimble equipment that is specified to use it.
 - Use the battery only for its intended use and according to the instructions in the product documentation.
-

When the internal temperature of the receiver is greater than 50°C (122°F) or less than 5°C (41°F), the internal battery charger stops charging and the receiver's display shows **Charger Disabled, Temp Limited**. However, the receiver will still draw its power from the external DC source, extending the operating time in the field.

When the external DC voltage is less than 15 V DC, an **X** is displayed across the battery status icon on the front panel display, which indicates that the internal charger is off.

Storing the Lithium-ion battery

If you must store a Lithium-ion battery for long periods, make sure that it is fully charged before it is stored, and that you charge it at least once every three months while it is stored.

Do not allow a battery that is in storage to discharge to below 5 V. A battery that reaches deep discharge level (5 V or less) cannot be recharged and must be replaced. (To protect a battery that is in use from deep discharge, the receiver switches power sources or stops drawing power when the battery pack discharges to 5.9 V.)

All batteries discharge over time when not in use, and they discharge faster in colder temperatures. Do not store the receiver at temperatures outside the range -40°C to $+70^{\circ}\text{C}$ (-40°F to $+158^{\circ}\text{F}$).

Using the Lithium-ion battery as a Universal Power Supply (UPS)

The receiver has an internal Lithium-ion battery. The internal battery will only charge from an external power source that delivers more than 15 volts, for example, an AC power adaptor. The receiver is supplied with a mains power supply unit that recharges the battery inside the receiver when it is connected through the adaptor to the modem port or the Lemo port. When you use the receiver on large projects, from a permanent or semi-permanent base station location in a site trailer, Trimble recommends that you use this power supply at all times to keep the internal battery charged. This provides an uninterrupted power supply and will keep the site operational for more than 10 hours after a power failure.

Keep all batteries on continuous charge when not in use. You can keep batteries on charge indefinitely without damage to the receiver or to the batteries.

Removing the rechargeable Lithium-ion battery

The internal Lithium-ion battery should be removed only at an authorized Trimble Service Center. If the battery is removed at an unauthorized service center, the remaining warranty on the product will be void.

Setup Guidelines

In this chapter:

- [Base station operation guidelines](#)
- [Rover operation guidelines](#)

GPS Real-Time Kinematic (RTK) operation provides centimeter-level accuracy by eliminating errors that are present in the GPS system. For all RTK operations, you require both a base station and a rover receiver.

This chapter introduces the concepts of base station and rover operation, provides information to help you identify good setup locations, describes best practices for setting up the equipment, and outlines the precautions that you need to take to protect the equipment.

***Note** – This chapter provides setup information for all the receivers in the SPS GPS receiver family.*

Base station operation guidelines

A base station consists of a receiver that is placed at a known (and fixed) position. The receiver tracks the same satellites that are being tracked by the rover receiver, at the same time that the rover is tracking them. Errors in the GPS system are monitored at the fixed (and known) base station, and a series of position corrections are computed. The messages are sent through a radio link to the rover receiver, where they are used to correct the real time positions of the rover.

Base station components

The base station has the following components:

- GPS receiver
- GPS antenna
- Base station radio
- Power supply

GPS receiver and GPS antenna

The base station GPS receiver can be one of following types:

- A Smart GPS antenna, such as the SPSx81, which incorporates a GPS receiver, GPS antenna, power supply, and radio into a single compact unit. A Smart GPS antenna can be rapidly set up on a tripod, fixed height tripod, or T-Bar anywhere that is convenient on the jobsite.
- A Modular GPS receiver, such as the SPSx51, which incorporates a GPS receiver, power supply, and radio in a single unit. The GPS antenna (and, optionally, the base station radio antenna) is separate from the receiver. Because the GPS antenna is separate, you can use the following optimized components:
 - a geodetic antenna with large ground plane, to eliminate multipath (the major source of GPS errors) at the base station
 - a high-gain or directional radio antenna, to increase broadcast range and to provide maximum coverage

You can also place a modular GPS receiver in an easily accessible and secure location, safe from theft and the weather, while the antennas are placed high on a tower or building, clear of obstructions and able to deliver maximum performance.

You can use either type of receiver in a permanent, semi-permanent, or daily quick setup configuration. If semi-permanent or permanent operation is required, however, the modular receiver delivers significant advantages.

Base station setup guidelines

For good performance, observe the following base station setup guidelines:

- Place the GPS receiver in a location on the jobsite where equal range in all directions provides full coverage of the site. This is more important on larger jobsites, where the broadcast range of the base station radio may limit the operations of the GPS system.
- Place the GPS antenna in a location that has a clear line of sight to the sky in all directions. Do not place the GPS antenna near vertical obstructions such as buildings, deep cuttings, site vehicles, towers, or tree canopy.
- Place the GPS and radio antennas as high as practical. This minimizes multipath from the surrounding area, and enables the radio to broadcast to the maximum distance.

Note – The GPS antenna must have a clear line of sight to the sky at all times during operation.

- Choose the most appropriate radio antenna for the size and footprint of the site. The higher the gain on the antenna, the longer the range. If there is more focus on the transmission signal, there is a reduced coverage area. A 3 db or 5 db gain antenna provides a mix of good range and reasonable directional coverage.
- Make sure that the GPS receiver does not lose power. The GPS receiver has an integrated battery, which has to be charged. To operate continuously for more than a day without loss of power at the base station, provide external power. Sources of external power include:
 - AC power
 - 12 V car or truck battery
 - Trimble custom external battery pack
 - Generator power
 - Solar panel

When you use an external power supply, the integrated battery provides a backup power supply, enabling you to maintain continuous operation through a mains power failure.

When the GPS receiver is connected to a power source greater than 15 V, the integrated battery is continuously charged from the connected power source. This helps to ensure that the battery stays charged (SPSx51 only).

- Do not locate a GPS receiver, GPS antenna, or radio antenna within 400 meters (about 1,300 feet) of:
 - a powerful radar, television, or cellular communications tower
 - another transmitter
 - another GPS antenna

Cell phone towers can interfere with the base station radio broadcast and can stop corrections from reaching the rover receiver. High-power signals from a nearby radio or radar transmitter can overwhelm the receiver circuits. This does not harm the receiver, but can prevent the receiver electronics from functioning correctly.

Low-power transmitters, such as those in cell phones and two-way radios, do not interfere with receiver operations.

- Do not set up the base station directly beneath or close to overhead power lines or electrical generation facilities. The electromagnetic fields associated with these utilities can interfere with GPS receiver operation. Other sources of electromagnetic interference include:
 - Gasoline engines (spark plugs)
 - Televisions and computer monitors
 - Alternators and generators
 - Electric motors
 - Equipment with DC-to-AC converters
 - Fluorescent lights
 - Switching power supplies
- Place the GPS receivers in a protected and secure location. If the base station is in the center of a jobsite where heavy machinery is operating, place flags around the base station to warn operators of its existence.
- If you place the SPSx51 Modular GPS receiver in a lock box on the jobsite to protect the receiver from theft or from the weather, shield the lock box from direct sunlight and provide ventilation for the receiver through an inlet and extractor fan. A receiver that has a broadcast radio generates significant heat. Do not allow the temperature in the box to exceed 50 °C (122 °F).

If working in a cold climate, you may need to provide heat to the receiver. Do not operate the receiver below -40 °C (-40 °F).

- Trimble recommends that, wherever possible, you keep GPS receiver equipment dry. The receivers are designed to withstand wet weather, but keeping them dry prolongs their life and reduces the effects of corrosion on ports and connectors. If the equipment gets wet, use a clean dry cloth to dry the equipment and then leave the equipment open to the air to dry. Do not lock wet equipment in a transport case for prolonged periods. Avoid exposing the GPS receiver to corrosive liquids and salt water wherever possible.

- Trimble recommends that you install lightning protection equipment at permanent base station locations. Equipment should include a gas capsule lightning protector in the GPS and radio antenna feed line and appropriate safety grounding. A static dissipater near the antennas can reduce the likelihood of a direct lightning strike. Also protect any communications and power lines at building entry points. For more information, contact your local Trimble dealer, or go to the Huber and Suhner website (www.hubersuhnerinc.com).
- Trimble recommends that you use surge protection equipment on all permanently installed equipment.

Permanent installation antenna cabling for the SPSx51 Modular GPS receiver

Many permanent base station installations have unique cabling requirements. Depending on the available infrastructure, you may need to mount the antenna a considerable distance from the receiver.

The SPSx51 can withstand a loss of 12 dB between the GPS antenna and the receiver. The degree of loss in a coaxial cable depends on the frequency of the signal passing through it. [Table 4.1](#) lists some common cable types and the maximum length you can use before an inline amplifier for GPS frequencies is required.

Table 4.1 Maximum cable lengths

Cable type	Maximum length (for use without an inline amplifier)
RG-214	30 m (100 ft)
LMR-400	70 m (230 ft)
LMR-500	85 m (280 ft)
LMR-600	106 m (350 ft)
Heliac LDF4/50	165 m (540 ft)
Heliac LDF4.5/40	225 m (740 ft)

Rover operation guidelines

The second part of the RTK GPS system is the rover receiver.

The rover receiver is mounted on a pole, vehicle, marine vessel, or in a backpack, and is moved between the points that require measurement or stakeout. The rover receiver is connected to a base station or to a source of RTK corrections such as a virtual

reference station system. The connection is provided by an integrated radio, a cellular modem in the controller, or through an external cellular phone that is connected to the receiver either by Bluetooth wireless technology or by means of a cable.

The correction stream for some other positioning solutions, such as SBAS (WAAS/EGNOS/MSAS) and the OmniSTAR service¹, is broadcast through geostationary satellites, and detected by the GPS antenna itself. No integrated radio or base station is required.

Rover receiver components

The rover receiver has the following components:

- GPS receiver
- GPS antenna
- Optional integrated radio receiver and antenna for RTK operations
- Optional items for the different mounting options (see below)

In most rover applications, the receiver operates entirely from its own integrated battery unit. On a vehicle or on a marine vessel, however, an external power supply can be used. Use an external power supply if one is provided. The internal battery then acts as a uninterruptible power supply, covering any external power failures.

Choose a rover receiver according to the needs of the job:

- A Smart GPS antenna, such as the SPSx81, incorporates the GPS receiver, GPS antenna, power supply, and receive radio into a single compact unit. A Smart GPS antenna can be rapidly set up on a pole, vehicle, or backpack. This makes it easy to carry when you are measuring around the jobsite.
- A Modular GPS receiver, such as the SPSx51, incorporates the GPS receiver, receive radio, and power supply into a single unit. The GPS antenna and, optionally, the receive radio antenna, is separate from the receiver. When you use a modular GPS receiver as a rover, you can use optimized components placed in the best locations for your application. For example:
 - A small, lightweight rover antenna can be mounted on a pole or backpack; placed in a high, inaccessible location on a marine vessel mast or cabin; or placed on a site vehicle roof or truck bed.
 - A rubber duck radio antenna, or an external radio antenna, can be mounted on a vehicle or vessel roof to provide maximum coverage.

A Modular GPS receiver can be placed in a location that is both easily accessible and safe from theft and the weather. The antennas can be placed high on a vehicle or vessel roof, clear of obstructions and able to deliver maximum performance.

¹ OmniSTAR is available only with the SPSx51 Modular GPS receivers.

Rover receiver setup guidelines

For good rover operation, observe the following setup guidelines:

- Place the GPS antenna in a location that has a clear line of sight to the sky in all directions. Do not place the antenna near vertical obstructions such as buildings, deep cuttings, site vehicles, towers, or tree canopy. GPS rovers and the base station receive the same satellite signals from the same satellites. The system needs five common satellites to provide RTK positioning.
- Place the GPS and radio antennas as high as possible to minimize multipath from the surrounding area. The receiver must have a clear line of sight to the sky at all times during operation.
- GPS satellites are constantly moving. Because you cannot measure at a specific location now does not mean that you will not be able to measure there later, when satellite coverage at the location improves. Use GPS planning software to identify the daily best and worst satellite coverage times for your location and then choose measurement times that coincide with optimal GPS performance. This is especially important when operating in the worst GPS locations. The Trimble Planning software is on the *Trimble SPS GPS Receiver CD* included with the receiver. You can also download the Trimble Planning software from the Trimble website (www.trimble.com/planningsoftware_ts.asp).
- The SPS851/SPS751 can track the GPS L2C modernization signal. Additionally, the SPS851 can optionally track the GPS L5 modernization signal and some receivers can also track the GLONASS satellite constellation (for more information, see [GPS satellite signal tracking, page 114](#)). These signals help you to get positions at the worst times of the day and in the worst GPS locations, but do not guarantee that you will.
- To get a fixed position solution with centimeter accuracy, initialize the rover receiver. For initialization to take place, the receiver must track at least five satellites that the base station is also tracking. In a dual-satellite constellation operation, for example, GPS and GLONASS, the receiver must track at least six satellites.
- To maintain a fixed position solution, the rover must continuously track at least four satellites that the base station is also tracking. In a dual-satellite constellation operation, for example, GPS and GLONASS, the receiver must track at least five satellites. The radio link between the base and rover receivers must also be maintained.
- Loss of the satellite signals or loss of the radio link results in a loss of centimeter position accuracy. From Fixed, the receiver changes to Float or Autonomous mode:
 - In Float mode, the rover has connection to the base station through a radio, but has not yet initialized.
 - In Autonomous mode, the rover has lost radio contact with the base station receiver, and is working by itself with the available GPS signals.

- On a vehicle or marine vessel, place the GPS antenna in a location as free from shock and vibration as possible. For the modular GPS receivers, a single magnetic mount is normally sufficient to hold the antenna in a suitable location, whereas for the larger smart antenna, a triple magnetic mount is normally recommended. Good alternatives include a 5/8" thread bolt in a suitable location on the roof bars, or a door-mounted pole bracket.
- To mount the modular GPS receiver on a pole, use two pole mounting brackets and a second tripod clip (P/N 571 204 300). See [Figure 4.1](#).



Figure 4.1 Rod mount for a modular GPS receiver

To mount the modular GPS receiver on a marine vessel, use the receiver bracket (P/N 56830-00). For marine moving base and heading applications, use the receiver bracket to mount two receivers together.

- Make sure that the rover receiver does not lose power. An SPSx51 is typically powered by its internal battery. You cannot change the battery, but the charge typically lasts for longer than a working day. If you do not use the rover receiver very often, ensure that it is charged at least every three months. For vehicle operation or marine vessel operation, Trimble recommends that you use an external power source so that the internal battery can be saved for times when the receiver is being used off the vehicle or vessel.

- Do not locate the receiver or antenna within 400 meters (about 1,300 ft) of powerful radar, television, cellular communications tower, or other transmitters or GPS antennas. Low-power transmitters, such as those in cellular phones and two-way radios, normally do not interfere with receiver operations. Cellular communication towers can interfere with the radio and can interfere with GPS signals entering the receiver. This does not harm the receiver, but it can prevent the receiver electronics from functioning correctly.
- Do not use the rover receiver directly beneath or close to overhead power lines or electrical generation facilities. The electromagnetic fields associated with these utilities can interfere with GPS receiver operation. Other sources of electromagnetic interference include:
 - gasoline engines (spark plugs)
 - televisions and computer monitors
 - alternators and generators
 - electric motors
 - equipment with DC-to-AC converters
 - fluorescent lights
 - switching power supplies
- Trimble recommends that, wherever possible, all GPS receiver equipment is protected from rain or water. Although, the receivers are designed to withstand all wet weather conditions, keeping the receivers dry prolongs the life of the equipment and reduces the effects of corrosion on ports and connectors. If the equipment gets wet, use a clean dry cloth to dry the equipment and then leave the equipment open to the air to dry. Do not lock wet equipment in a transport case for prolonged periods. Wherever possible, avoid exposing the GPS receiver to corrosive liquids and salt water.
- If you are using the rover receiver in open spaces, Trimble recommends that you stop work during electrical storms where the risk of lightning strike is high.
- Where cables are involved, Trimble recommends that you use cable ties to secure the cables to the rod or other equipment to avoid inadvertent snagging while moving about the jobsite. Be careful not to kink, twist, or unnecessarily extend cables, and avoid trapping them in vehicle doors or windows. Damage to cables can reduce the performance of GPS equipment.

Internal radio setup for rover operations

The internal radio of the SPS GPS receiver is delivered with the transmit (Tx) radio frequencies preprogrammed into the receiver. To add receive (Rx) radio frequencies to 450 MHz radios, use the WinFlash utility or web interface (see [Appendix C, Adding UHF Internal Radio Frequencies](#)). Network channels can be selected for the 900 MHz radios.

Once the radio frequencies are configured, use the controller or receiver to select channel frequencies during base station or rover setup operations.

Setting up the Receiver

In this chapter:

- Connecting the receiver to external devices
- Common ways to set up a base station
- Common ways to set up a rover receiver
- Setting up a pair of GPS receivers to provide heading

This chapter provides guidelines for setting up the receiver as a base station, or as a rover receiver in a range of common use scenarios.

This chapter also describes the procedure for setting up a pair of receivers for heading and moving base marine construction applications.

***Note** – This chapter provides setup information for all the receivers in the SPS GPS receiver family.*

Connecting the receiver to external devices

You can connect an SPSx51 Modular GPS receiver to the following devices:

- a Trimble controller running Trimble SCS900 Site Controller software
- an external radio-modem
- HYDRO*pro* software

Trimble controller with SCS900 Site Controller software

You can operate an SPS GPS receiver with any Trimble controller, for example, a TSC2[®] or Trimble CU controller, that is running the SCS900 software. Typically, the receiver and the controller operate from their own individual power sources. The receiver and controller can communicate through Bluetooth wireless technology and can be connected without a cable. However, if a cable is required, [Table 5.1](#) shows how to connect the cables for each combination of SPS GPS receiver and Trimble controller.

Table 5.1 Connecting to a Trimble controller running the SCS900 Site Controller software

To connect a	Use cable part number ...	Use this cable connector ...	and connect the cable to ...
SPSx51 Modular GPS receiver to a ...			
TSC2	59046	DB9 Lemo	TSC2 SPSx51
	59043	DB9 DB9	TSC2 SPSx51
TCU	53004007	6-pin Hirose	TCU
		Lemo	SPSx51
	53002007	6-pin Hirose DB9	TCU SPSx51
TSCe™	31288-xx ¹	Lemo	TSCe
		Lemo	SPSx51
ACU	44147	4-pin Hirose	ACU
		Lemo	SPSx51

¹This cable is available in different lengths. The -xx indicates the length of the cable, in meters.

External radio-modems

The most common data link for Real-Time Kinematic (RTK) operation is a radio. The receiver is available with the following internal radios:

- 410–430 MHz (Tx/Rx, Rx only, or Tx only)
- 430–450 MHz (Tx/Rx, Rx only, or Tx only)
- 450–470 MHz (Tx/Rx, Rx only, or Tx only)
- 900 MHz (Tx/Rx, Rx only, or Tx only)

Note – “Tx” indicates that the radio transmits corrections. “Rx” indicates that the receiver receives corrections. “Tx/Rx” indicates that the radio both transmits and receives corrections.

If the receiver does not have an internal transmit radio, or you want to connect to higher power or to a secondary external transmit radio or cellular modem, use the 26-pin port, the Lemo port, or Bluetooth wireless technology.

The receiver supports the following Trimble base radios:

- SiteNet™ 450
- TRIMMARK™ 3
- TRIMTALK™ 450
- Trimble SNB900
- Trimble PDL450
- Trimble HPB450

The receiver also supports third-party transparent radios and third-party cellular modems.

When used with an SPSx51 GPS receiver, most external radios require an external power source. Only the Trimble SNB900 radio-modem has an internal battery and does not require external power.

Configure the external radio separately, using either the configuration program for the external radio or the radio display and keypad.

To configure the receiver for RTK operation, follow the base setup procedure to set the following parameters:

- Set the base station coordinates
- Enable the RTCM or CMR+™ corrections stream on the selected serial port.

Common ways to set up a base station

You can set up a base station in different ways depending on the application, coverage area, degree of permanence versus mobility, and available infrastructure. Before you set up a base station, please read [Chapter 4, Setup Guidelines](#).

Setting up a base station for permanent or semi-permanent installation

For construction applications, where machine and site positioning operations using GPS will be carried out over a long time (weeks, months, or years), ensure that you choose the base station location carefully.

A semi-permanent or permanent base station helps to eliminate the types of error that can result from repeated daily setups, and ensures that you always use the GPS antenna at the exact original location. The requirement for a permanent base station setup increases as more receivers that use the base station as a source of corrections, increases the cost of any base station downtime.

On the largest jobsites, and on those that remain operational for the longest time, a permanent or semi-permanent installation is a popular solution. A modular GPS receiver is typically used as the base station, located in a site office or trailer where it is easy to access (to check or configure), and where it is secure from theft and the weather. The GPS and radio antennas are normally mounted on a permanent structure on the roof of the building, where they are high and clear from obstructions and where the radio antenna can provide the maximum range of operation.

Trimble recommends that you use the Trimble Zephyr Geodetic™ Model 2 GPS antenna. This antenna has a large ground plane that reduces multipath, providing the best GPS performance at the base location. The antennas are connected to the receiver by high quality RF cables.

The receiver is connected to a permanent power supply (mains or generator power). The internal battery of the receiver is always being charged, and acts as an uninterruptible power supply if there is a power failure. In some cases, the receiver may also be connected by an Ethernet cable to the Internet, so that it can be monitored and configured from a remote location, and can warn an administrator by email or text message if there is a change to the configuration or status. In these situations, the receiver can transmit GPS RTK corrections to a remote radio or receiver over the Internet, for rebroadcast requirements, without using repeaters.



Figure 5.1 SPSx51 receiver permanent installation

Setting up a base station for daily site use: T-Bar

For construction applications where a daily setup and takedown of equipment is required for security reasons, Trimble recommends that you use a T-Bar setup.

The T-Bar consists of a post mounted in concrete (so it cannot move), which has a solid metal T-Bar mounted to it to provide lateral and vertical separation between the GPS antenna and radio antenna. The T piece of the T-Bar has a vertical rod at each end. Each end terminates in a 5/8"×11 thread to which the antennas can be mounted. Trimble recommends that one end is clearly marked **GPS** and the other end is clearly marked **Radio** so that at each daily setup, the GPS and radio antennas are mounted at the same location. Switching antennas by mistake introduces a position error in all resulting measurements. You can buy the parts you need to make a T-Bar from any reputable hardware store. Make certain that the T-Bar cannot rotate after construction. Rotation of the T-Bar can introduce a position error into all subsequent measurements.

On the upright post, mount either a bracket (to which the GPS receiver can be mounted), or a well-ventilated lockbox (in which the GPS receiver itself can be secured).

Each day, mount the GPS antenna on the **GPS** end of the T-Bar and the radio antenna on the **Radio** end of the T-Bar. Connect the antennas to the receiver using the appropriate cables. The receiver uses its own integrated battery, or an external 12 V battery through the 12 V crocodile clips cable that are provided with the receiver. If you choose to use AC power, remember that the heat generated by the charging process and the radio transmitter increases the need for good ventilation around the receiver.

In such scenarios, an SPSx81 Smart GPS antenna is also often used. Simply mount the SPSx81 on the T-Bar, and optionally connect to an external battery or radio unit.

Advantages

Use of a T-Bar setup ensures that the base station is set up with exactly the same position and height every day. This helps eliminate the errors typically associated with daily tripod setup. For example, wrong antenna height, base not set up over the point, base set up in the wrong location.

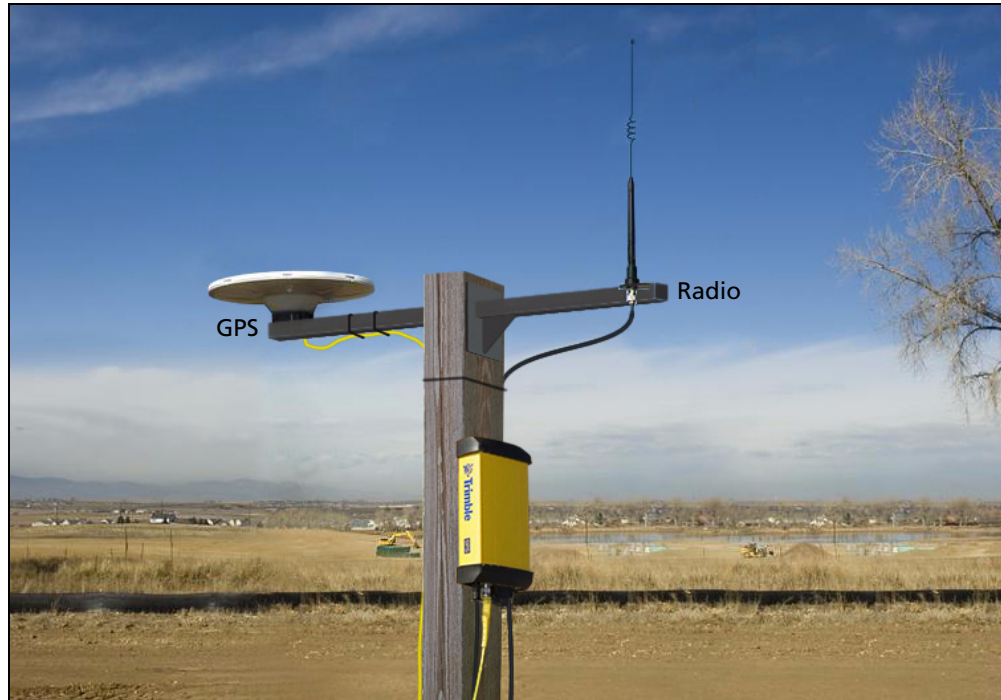

Figure 5.2 System set up on a T-bar showing an external radio antenna to gain longer range

Setting up a mobile base station: Tripod and fixed height tripod

If you are repeatedly moving between jobsites, or if you are visiting a jobsite for the first time before a T-Bar or similar setup can be established, Trimble recommends that you use either a tripod and tribrach setup, or a fixed height tripod.

The fixed height tripod is quicker and easier to set up over a control point. It allows you to re-establish the antenna height exactly so that the receiver can be set up faster without using the SCS900 software or without needing to enter a revised antenna height in the receiver front panel. Take great care to ensure that the GPS antenna is set up accurately over the control point, and that the GPS antenna height is measured accurately, in the right way (vertical or slope height) to the right location on the antenna (base of antenna or to a specified location on the antenna). When you start the rover receiver, it is extremely important to check in, at one or more known locations, to check for possible position or height errors. Checking in at a known location is good practice and can avoid costly errors caused by a bad setup.

Typically, the tripod and fixed height tripod methods do not give significant height clearance above the ground, and can reduce the range of operation caused by radio limitations.

Tripod and tribrach setup

In the tripod setup, the tripod is located over the control point, and the tribrach and tribrach adaptor is mounted on the tripod and centered over the point.

1. Mount the GPS antenna on the tribrach adaptor.
2. Clip the GPS receiver to the tripod.
3. Connect the GPS antenna to the receiver using the appropriate cable.
4. If necessary, connect the GPS receiver to an external 12 V power supply. Use the crocodile clip cable or the Trimble custom power pack.

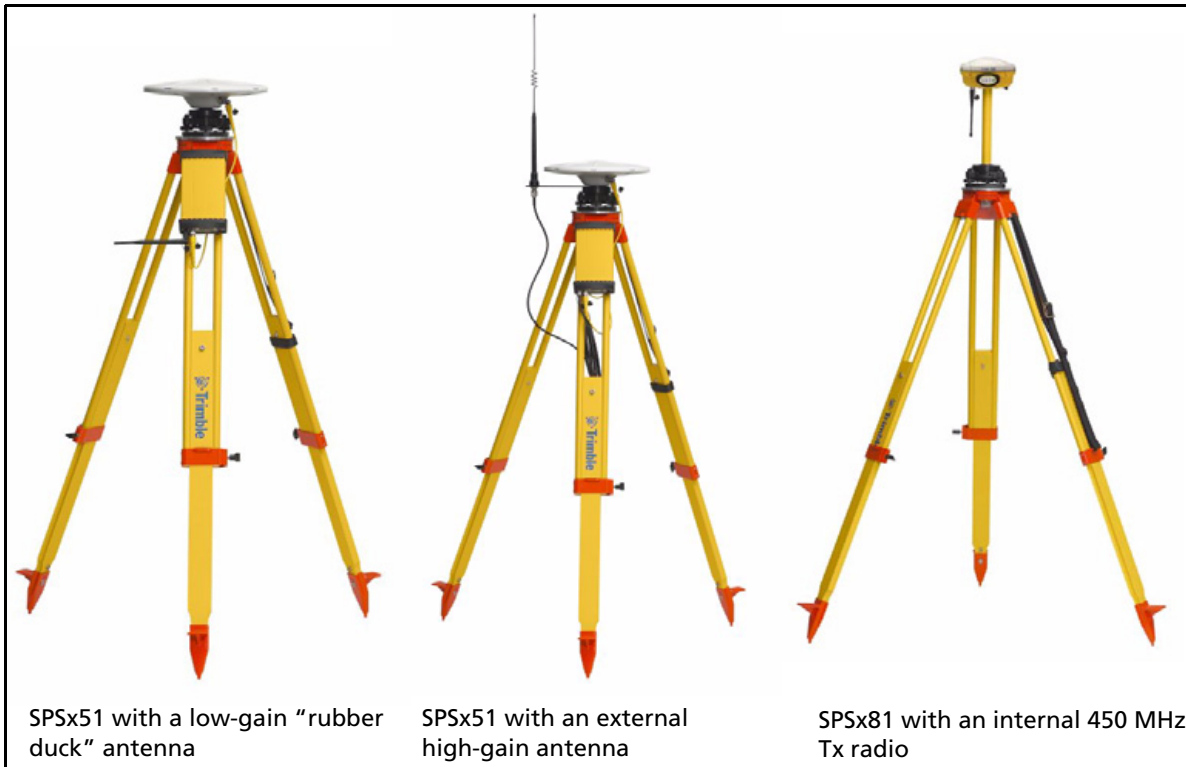

Figure 5.3 Tripod and tribrach setup

Fixed height tripod setup

A fixed height tripod setup is similar to a tripod setup, but is simplified by the central leg of the tripod, that is placed directly on the control point. If the central leg is leveled accurately, the fixed height tripod is quick and easy to set up, and provides an accurate way to measure the true antenna height.

1. Set up the tripod over the control point.
2. Attach the GPS antenna to the head of the tripod.
3. If using an external high-gain radio antenna, mount the radio antenna to the radio antenna bracket that is attached to the head of the tripod (beneath the GPS antenna). See [Figure 5.4](#).
4. Hook the receiver to the center leg of the tripod, using the tripod clip.

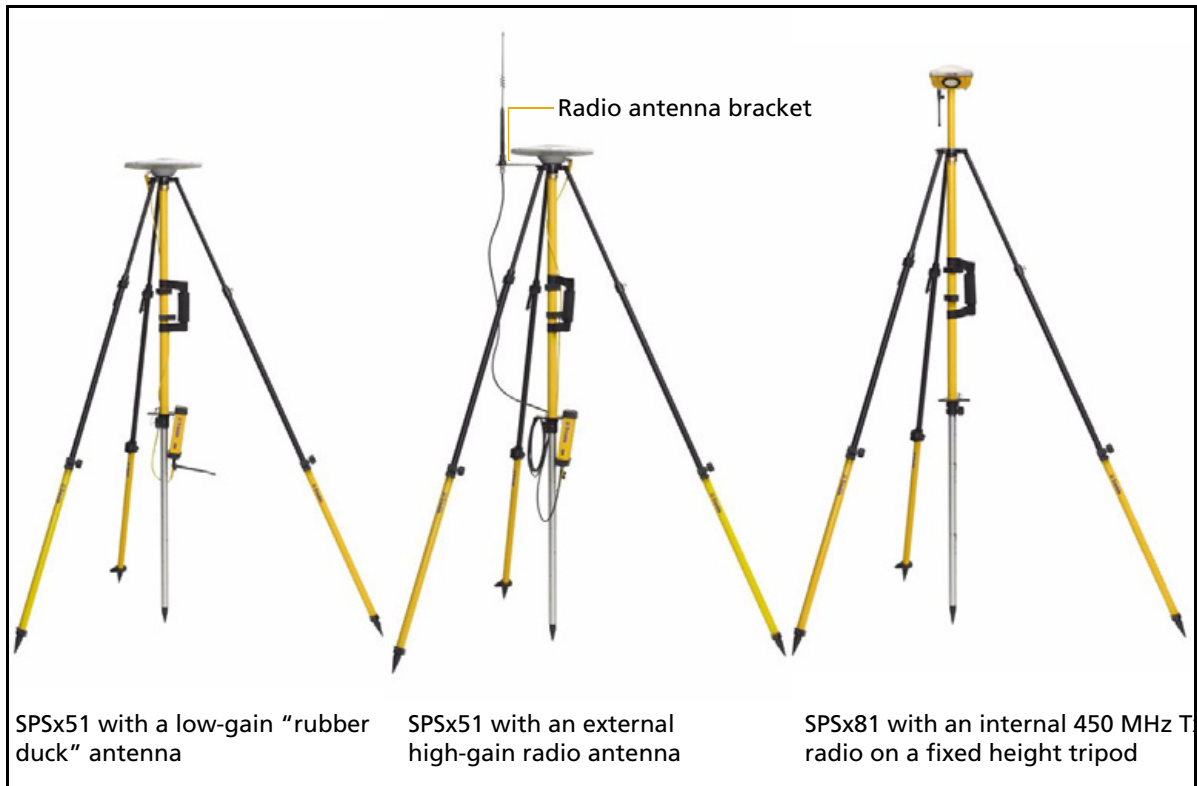

Figure 5.4 Fixed height tripod setup

Common ways to set up a rover receiver

You can set up a rover receiver in different ways depending on the application. The components that make up a rover receiver are:

- GPS receiver
- GPS antenna
- controller/computer
- rod mounting equipment, including a rod, receiver bracket, and controller bracket
- vehicle mounting equipment, including a suction cup and ball joint, extension arm, controller bracket, magnetic antenna mount, and necessary cables.
- backpack equipment, including backpack and antenna-mounting rod
- marine vessel mounting equipment, including receiver bracket, cables, antenna, and radio antenna brackets

Setting up the rover receiver on a jobsite vehicle



CAUTION – This following rover setup is suited only to offroad (jobsite) vehicle use. Do not use this method on a vehicle that is driven at speed or in traffic.

1. Mount the GPS antenna for the receiver on the roof of the vehicle. Use a single magnetic mount or a 5/8"×11 thread bolt attached to the roof bars. Run the GPS antenna cable for the receiver into the vehicle either through a rubber grommet in the roof, or through the passenger door window, which needs to be left slightly open during operation.
2. Place and secure the GPS receiver in a convenient location in the vehicle.
The GPS receiver can be controlled through the controller connected using Bluetooth wireless technology.
If the receiver is not connected to vehicle power, then the receiver needs to be accessed only to turn it on at the start of each measurement session. It may be more convenient if the SPSx51 is placed in a location where the vehicle operator can see the keypad and display, to monitor receiver status and to configure settings as required. Most receiver capability can be controlled using the SCS900 Site Controller software.
3. Attach the suction cup to the front windshield, dashboard, or other convenient location in the vehicle, making sure that it does not obstruct the driver's view.
4. Attach the RAM extension arm to the suction cup, and the controller bracket to the RAM extension arm.
5. Lock the controller into the controller bracket and then adjust the bracket until the controller is in the most convenient location. Make sure that the controller does not restrict visibility through the front windshield during vehicle use.
6. Lock the brackets so that the controller is held securely. If required, connect either the GPS receiver or the controller to an in-vehicle power supply as needed.



Figure 5.5 Configuring an SPSx51 from the cab. A Zephyr Model 2 antenna is mounted on the roof.

Setting up the rover receiver on a rod

For rod-based operation, mount the SPSx51 Modular GPS receiver as follows:

1. Mount the two rod brackets on the rod.
2. Tighten the top bracket, making sure that it is at a convenient height for the receiver.
3. Place the receiver in the slot in the rod bracket, and secure with the tripod clip.
4. Move the lower rod bracket down until it is over the second tripod clip on the receiver and then tighten the rod bracket onto the rod. The receiver is held in place between the two brackets.
5. Insert the controller into the controller bracket as shown opposite.
6. Use the 5/8" thread to attach the GPS antenna to the top of the rod.
7. Use the GPS antenna cable to connect GPS antenna to the receiver.



Setting up a rover receiver on a belt or in a backpack

If you prefer to work free of the weight of the receiver on a pole, you can mount the rover receiver on a belt (SPSx51 only) or carry it in/on a backpack (all receivers). When you wear the receiver on a belt, ensure that the display is always visible so that you can easily check the status of the receiver. If you carry the receiver in a backpack, use an external radio antenna mount to allow for optimal radio signal reception. If you use a low-gain antenna mounted directly on the receiver in a backpack, it may affect the radio signal reception and reduce the likelihood of obtaining an RTK Fixed solution.

Setting up a pair of GPS receivers to provide heading

The SPS551H receiver is permanently in Heading mode and, when combined with a suitable Trimble receiver, provides GPS heading. Other SPSx51 GPS receivers can also be paired for heading output if they can operate in Heading mode (see [Configuring the receiver pair](#), page 58).

The SPS551H is a dual-frequency GPS receiver with a dual-frequency antenna, but it does not operate as a stand-alone DGPS receiver. To compute a true north heading and to be capable of positioning, the receiver requires an output message from another SPSx51 receiver. To determine the precise vector between two moving objects, pair the SPS551H Heading add-on with any one of the following receivers:

- SPS551
- SPS751 Max
- SPS851

Connect the antenna on the SPS551H to the other receiver to determine the precise GPS heading between the two antennas. The SPS551H GPS receiver show the heading on the two-line display, and outputs the heading data in NMEA or binary format.



Tip – To create a single, compact GPS position and heading unit, use the mounting frame provided to stack the SPS551H GPS receiver on top of the other GPS receiver. See below. Use the Marine Heading Cable (P/N 57169-10) provided.

The Moving Baseline RTK positioning technique

In most RTK applications, the reference receiver remains stationary at a known location and the rover receiver can move. However, Moving Baseline RTK is an RTK positioning technique in which both reference and rover receivers can move about. Moving Baseline RTK is useful for GPS applications that require vessel orientation.

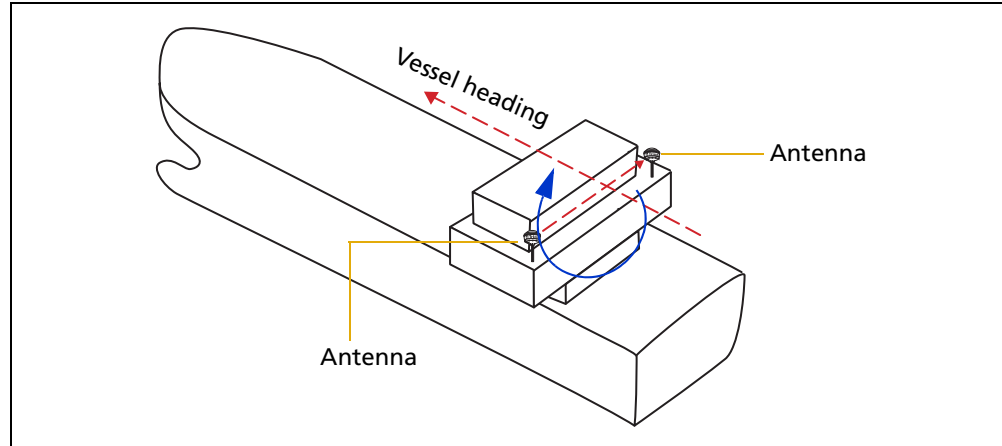

Figure 5.6 Vessel heading from Moving Baseline RTK

With Moving Baseline RTK, the reference receiver broadcasts Compact Measurement Record (CMR) data, while the rover receiver performs a synchronized baseline solution at 10 Hz. The resultant baseline solution has centimeter-level accuracy. To increase the accuracy of the absolute location of the two antennas, the Moving Reference receiver can use differential corrections from a static source, such as a shore-based reference station.

Mounting a pair of GPS receivers

To obtain a position and heading solution, you need to connect two receivers to make one compact unit. A mounting bracket and interconnecting cable is supplied with the SPS551H receiver. Set up the receivers, antennas, and cables as shown in [Figure 5.7](#).

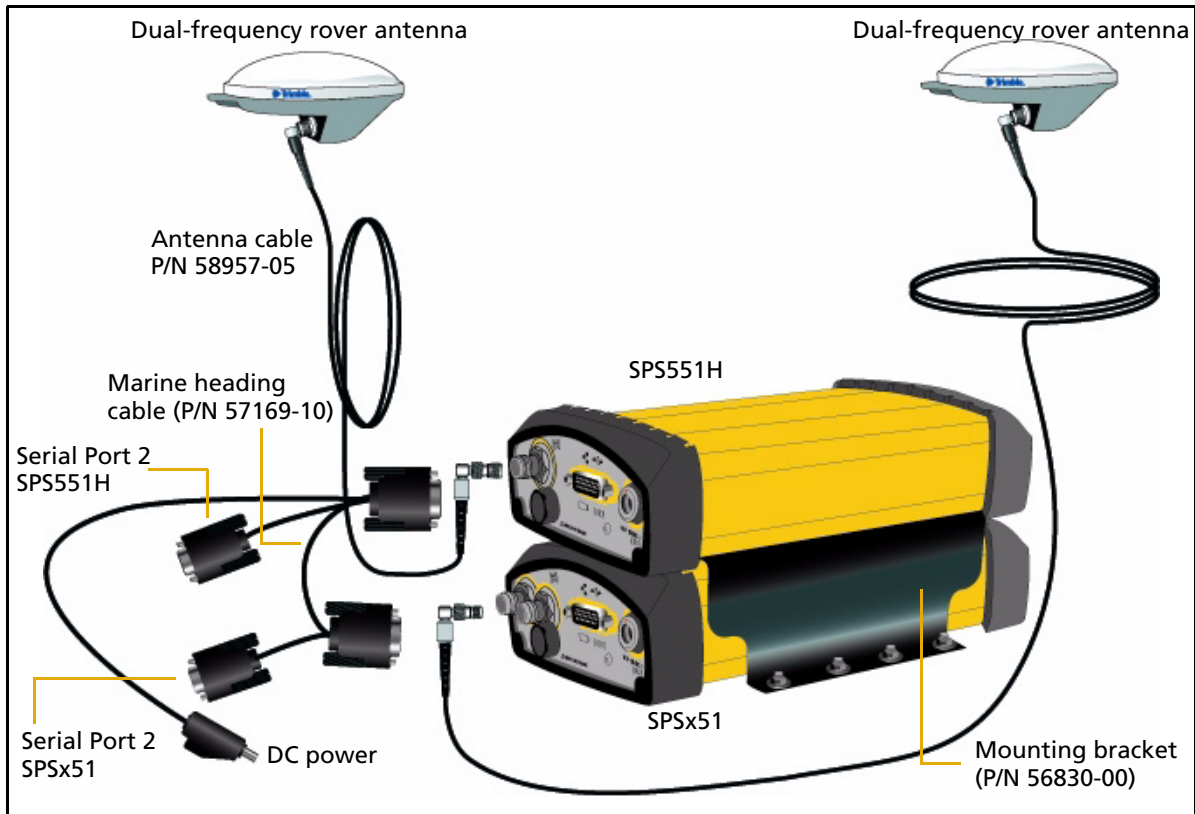

Figure 5.7 Installation setup for the SPS551H with another SPSx51 for position and heading

Assembling the receivers

Figure 5.8 shows an SPS551 and an SPS551H set up to provide a Heading solution. To assemble the receivers, you need a Phillips head #1 screwdriver and a 1/4" socket set or wrench (spanner).

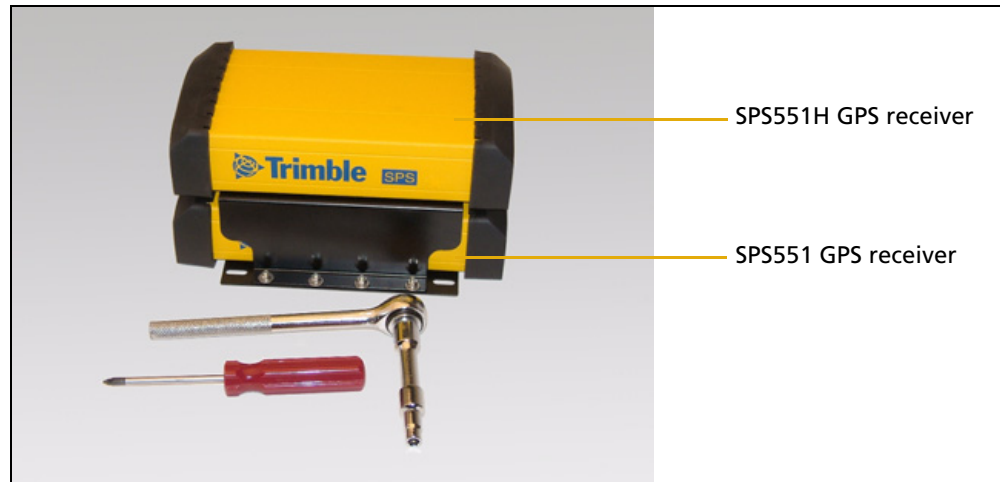
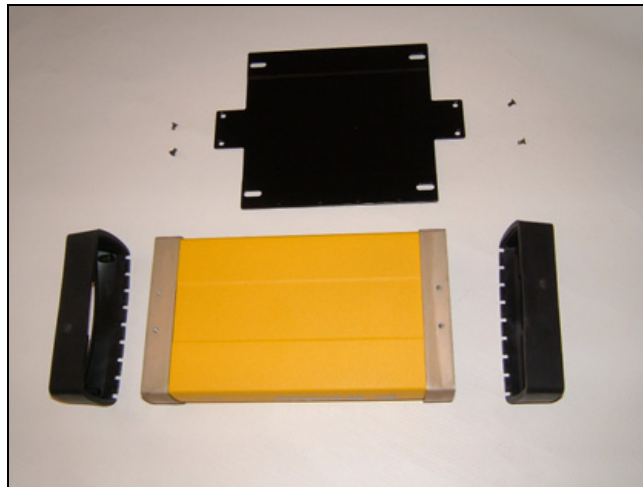

Figure 5.8 Completed assembly with the SPS551H GPS receiver on top

To assemble the receivers using the mounting frame that is provided:

1. Invert the SPSx51 GPS receiver and then remove the rubber endcaps.



2. Prepare the flat black plate and the four Posi screws. (These are part of the mounting frame.)
3. Position the black plate on the SPSx51 GPS receiver.

4. Use the four Posi screws to secure the plate to the receiver. (Secure two screws at each end.) The black plate is now attached to the bottom of the receiver.

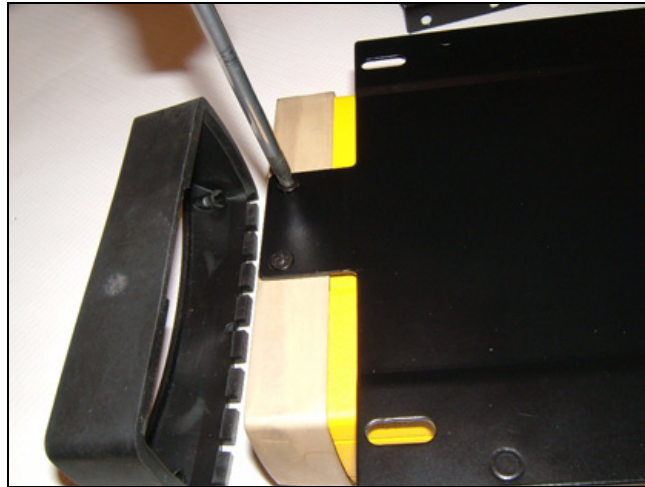

5. Replace the rubber endcaps.
6. Invert the receiver again. This returns the receiver to its normal orientation.
7. Set aside the receiver.
8. Invert the SPS551H receiver and then remove the rubber endcaps.

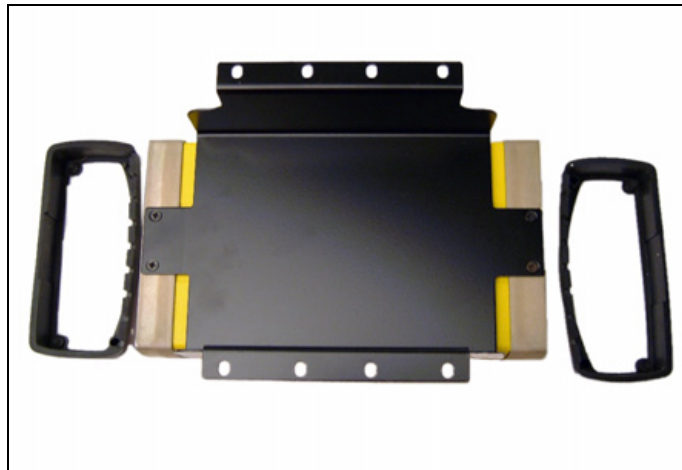

9. Position the black cradle on the SPS551H GPS receiver. (The black cradle is part of the mounting frame.)
10. Use the four Posi screws to attach the black cradle to the receiver. The black cradle is now attached to the bottom of the SPS551H.

11. Replace the rubber endcaps.

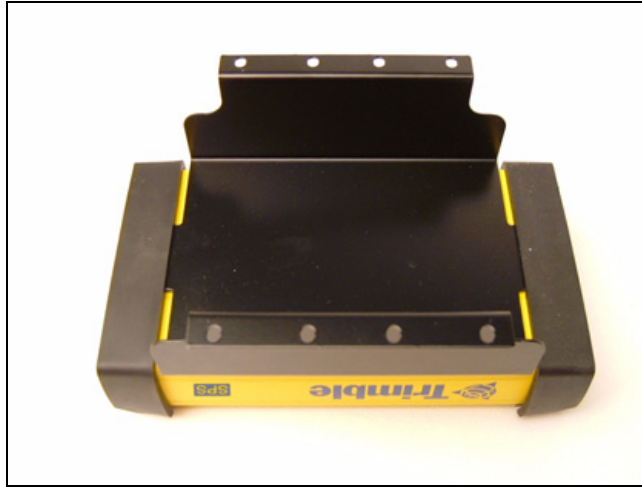

12. Place the black cradle on the black base plate. This places the SPS551H GPS receiver on top of the SPSx51 GPS receiver.



13. Make sure that the display is facing in the same direction on both receivers.
14. Prepare the eight nuts, spring washers, and flat washers.

15. Insert the first bolt. Attach the flat washer, the spring washer, and finally the nut and then tighten firmly. Secure all eight bolts in this way.

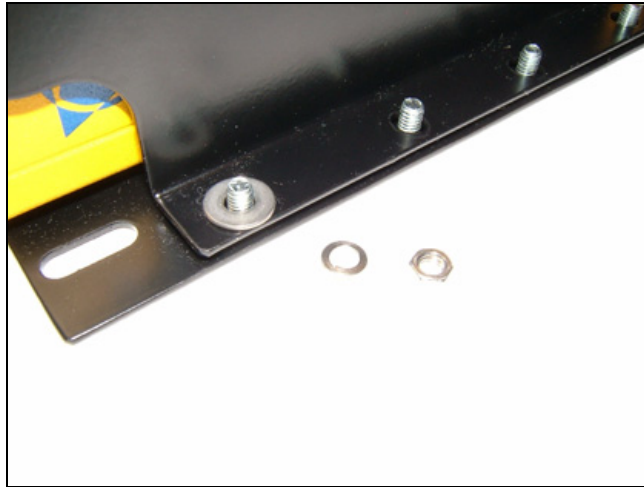

16. Attach one connector from the Marine Heading cable (P/N 57169-10) to the 26-pin connector on the rear of the SPS551H GPS receiver. Attach the other connector from the cable to the 26-pin connector on the rear of the SPSx51 receiver. The cable can be connected either way around.



The cable connects the two GPS receivers so that the Heading solution is available. The DC power lead on the cable supplies power to both receivers in the stack. The two DB9 female connectors on the cable access serial port 2 on each receiver.

Installing the receiver

Select a location at which all of the following conditions are met:

- the receiver is not exposed to temperature extremes
- the receiver is not exposed to moisture extremes (such as rain, snow, water blasters, or wash systems)
- the receiver is protected from mechanical damage
- you can connect and disconnect cables without placing undue stress on them

Mounting the antennas

You **must** install each antenna at the correct location. Poor or incorrect placement can influence accuracy and reliability.

Ideally, mount the two antennas as far apart as possible and at about the same height on the structure. Mount the antennas fore and aft along the vessel centerline or on a line that is at a known orientation to the centerline. For best results, rotate each antenna so that all antennas in the array point in the same direction. Always mount an antenna at a location that ensures a good view of the sky.

Follow these guidelines to select the antenna location:

- Choose an area with a clear view of the sky. The antenna must be above any metallic objects.
- Do not mount the antenna close to stays, electrical cables, metal masts, or other antennas.
- Do not mount the antenna near a transmitting antenna, a radar array, or near satellite communication equipment.
- Avoid areas with high vibration, excessive heat, electrical interference, and strong magnetic fields.

Use a 5/8"×11" stainless steel bolt to mount each of the antennas. There is a threaded bolt hole in the base of the antenna.

Configuring the receiver pair



One of the receivers must be nominated as a Heading unit. The other receiver is nominated as a Moving Base unit. For this configuration to work, you must use the Marine Heading cable (P/N 57169-10).

To set up the Heading unit:

1. From the Home screen, press  twice. The *Mode* screen appears.

2. Select *Heading* mode. The receiver display shows two extra settings for heading:
 - *Heading Adjustment*. Enter a positive value in decimal degrees. The value is applied to the raw heading value before it is output in the NMEA HDT message or displayed on the front panel of the receiver. This value is used when the two antennas are not mounted parallel to the vessel axis.
 - *Minimum Heading Solution*. Enter the minimum requirement for the GPS solution that will provide the heading value. The default of RTK Fixed provides the highest precision, but in conditions of extreme multipath or obstruction, an RTK Fixed solution may not be continuously available. In such conditions, select RTK Float if a lower precision is acceptable.

To set up the Moving Base unit:

1. From the Home screen, press  twice. The *Mode* screen appears.
2. Select *Moving Base* mode, and then press .

Interfacing using the NMEA protocol

The SPS551H GPS receiver can output messages such as NMEA HDT for heading, and NMEA GGA for position. The SPS551H always reports the solution status of the moving baseline solution that is being used to compute the heading. However, if the external computer must know the exact quality of the position, you can use the NMEA output from the base receiver. The base receiver reports the solution status of the position, for example, Fixed Integer, Floating, or DGPS.

Heading output

The heading output from an SPSx51 receiver that is in Heading mode is the True North Azimuth from the Heading antenna (this is the unit that receives moving base corrections) to the Moving Base antenna (this is the unit that outputs the moving base corrections). Heading output information is available in the following places:

- Receiver display
- Data outputs:
 - GSOF Attitude (see [Attitude](#), page 146)
 - NMEA HDT (see [HDT](#), page 124)
 - NMEA AVR (see [PTNL,AVR](#), page 125)

Configuring the Receiver Using the Keypad and Display







In this chapter:

- Button functions
- Power button operations
- Home screen
- Status screens
- Configuring the receiver as a base receiver
- Configuring the receiver as a rover receiver
- Configuring system settings
- Managing application files



The receiver features a keypad and display (see [Keypad and display, page 24](#)) so that you can configure the receiver without using a controller or computer.

Button functions

Use the buttons on the front panel to turn the receiver on and off and to check or change the receiver settings.

Button	Name	Function
	Power	Turns the receiver on and off. See the next section.
	Escape	Returns to the previous screen or cancels changes being made on a screen.
	Enter	Advances to the next screen or accepts changes made on a screen.
	Up	Moves the cursor between multiple fields on a screen or makes changes to an editable field.
	Down	Moves the cursor between multiple fields on a screen or makes changes to an editable field.
	Left	Moves the cursor between characters in a field that can be changed.
	Right	Moves the cursor between characters in a field that can be changed. Press this button to enter Edit mode.

Power button operations

Press the Power button  to turn the receiver on and off. In addition, you can tap  to return to the Home screen, or hold down  to perform the following operations:

To ...	Hold the  button for ...	Notes
turn off the receiver	two seconds	The display shows a countdown timer. When the display goes blank, release the Power button.
clear the almanac, ephemeris, and SV information	15 seconds	The display show a countdown timer. When the display goes blank, continue to hold the Power button. The display shows a countdown time to clear the almanac and ephemeris. When the counter reaches 0, release the Power button.
reset the receiver to its factory defaults and the default application file	35 seconds	The display show a countdown timer. When the display goes blank, continue to hold the Power button. The display show a countdown to clear the almanac and ephemeris. When the counter reaches 0, continue to hold the Power button. The display indicates a countdown to resetting the receiver. When the counter reaches 0, release the Power button.
force the receiver to power down	at least 60 seconds	If the reset method above does not work, use this method to force the receiver to turn off. When the Power LED goes off, release the Power button.

Home screen

The Home screen is the main screen displayed on the receiver. If the receiver is displaying another screen and is left idle for 60 seconds, you are returned to the Home screen. It shows the following information:

- Number of satellites being tracked:
 - When the receiver is in Base mode, the Home screen displays the number of satellites in view, that is, all satellites above the elevation mask. This is the number of satellites that the base station is sending data for.
 - When the receiver is in Rover, Heading, or Moving Base mode, the Home screen displays the number of satellites used to calculate the position.
 - If the receiver is set to use SBAS or OmniSTAR corrections, the Home screen displays the number of satellites that corrections have been received for.
 - If the receiver is computing an autonomous solution, the Home screen displays all satellites in view, that is, all satellites above the elevation mask.



Tip – You can also view these details using the Web browser (select *Receiver Status / Position*).

- Internal battery power remaining
- Current mode configuration
- Internal radio activity
- Internal radio channel or network

Status screens

The receiver has several view-only status screens that allow you to review the current settings of the receiver. The status screens provide the following information:

- Position solution and precisions
- CMR and RTCM IDs
- Base name and code
- Latitude, longitude, and height
- Antenna height
- Horizontal and vertical precision
- Receiver firmware version
- Receiver serial number
- Receiver IP address

To access these screens from the Home screen, press  or .







Configuring the receiver as a base receiver

To set up the SPSx51 as a base receiver, use AutoBase technology, the Trimble SCS900 Site Controller software, the receiver keypad, or an external computer.

The AutoBase feature automatically configures the receiver settings for you. The receiver obtains a position and outputs RTK corrections on the internal radio (if available) or on the LEMO port. See [Chapter 8, Automatically Setting up a Mobile Base Station Using AutoBase Technology](#).









The receiver is configured step-by-step to ensure that all appropriate settings are configured. To move between steps in the configuration process, press .



Configuring the receiver

1. In the Home screen, press . Use the *Operation Mode* screen to configure system settings, mode settings, or to view the SV (satellite) status. Mode Settings is the default setting.
2. Press . Use the *Mode* screen to select whether the receiver will operate as a base or rover. Base is the default setting.
3. Press . Use the *Base Station* screen to select whether the receiver is going to use a “Here” position or if the current coordinates in the receiver will be changed.
4. Press . When **Edit Current** begins to flash, the receiver is in Edit mode and you can change the current setting.
5. Press . The setting changes to New Base (Here).
6. Press  to accept the change.
7. Press  again. The *Base Name* screen appears. See next.

Changing the name and description of the base station







In the *Base Name* screen:

1. Press . When the first character of the base name begins to flash, the receiver is in Edit mode and you can change the current setting.
2. Press  or  to change the value of the character.
3. Press  to move the cursor to the next character.
4. Repeat [Step 2](#) through [Step 3](#) to enter the name of the base station. The name can be up to 16 characters. Press  to accept the change.
5. Press  again. Use the *Base Code* screen to change the code (description) for the base station.
6. Press . When the first character of the base code begins to flash, the receiver is in Edit mode and you can change the current setting.
7. Press  or  to change the value of the character.

8. Press  to move the cursor to the next character.
9. Repeat [Step 7](#) through [Step 8](#) to enter the code of the base station. The code can be up to 16 characters.
10. Press  to accept the change.
11. Press  again. The *Base Latitude* screen appears. See next.











Setting the reference latitude, longitude, and height of the base station

In the *Base Latitude* screen:

1. The base was set up with a “Here” position, so press .
2. The *Base Longitude* screen is used to change the reference longitude of the base station. The base was set up with a “Here” position, so press .
3. The *Point Height* screen is used to change the reference height of the base station. The base was set up with a “Here” position, so press .
4. Use the *Antenna Type* screen to select the type of antenna used with the receiver. Press . When the antenna name begins to flash, the receiver is in Edit mode and you can select an antenna.
5. Press  to scroll through the antenna models.
6. Once the correct antenna name appears, press  to accept the change.
7. Press  again. The *Measured To* screen appears. See next.













Measuring and changing the antenna height

In the *Measured To* screen:

1. Press . When the antenna measurement method begins to flash, the receiver is in Edit mode and you can select an antenna measurement method.
2. Press  to scroll through the measurement methods. Once the correct measurement method appears, press  to accept the change.
3. Press .
4. Use the *Antenna Height* screen to change the height of the antenna. Press . When the first character of the antenna height begins to flash, the receiver is in Edit mode and you can change the antenna height.
5. Press  or  to change the value of the character.
6. Press  to move the cursor to the next character.
7. Repeat [Step 5](#) through [Step 6](#) to enter the height of the antenna.
8. Press  to accept the change.
9. Press  again. The *Output* screen appears. See next.

Outputting corrections

In the *Output* screen:

1. Press  to enter Edit mode for the port.
2. Press  or  to change which port will be used to output corrections.
3. Press  to accept the change.
4. Press  to move the cursor to the *Format* field.
5. Press  to enter Edit mode for the format.
6. Press  or  to change which correction message will be output on the port.
7. Press  to accept the change.
8. Press  again.
9. Use the *NMEA* screen to set up NMEA outputs from the receiver. Press  to accept the default of no NMEA messages.
10. Use the *GSOE* screen to set up GSOE outputs from the receiver. Press  to accept the default of no GSOE messages.
11. Use the *RT17* screen to set up RT17 outputs from the receiver. This screen only appears if you have the real-time Binary Output option installed. Press  to accept the default of no RT17 messages.







The Home screen appears and the base setup is complete.

Configuring the receiver as a rover receiver



You can use the Trimble SCS900 Site Controller software or the receiver keypad to set up the SPSx51 as a rover receiver.

The receiver is configured step-by-step to ensure that all appropriate settings are configured. To move between steps in the configuration process, press .





Configuring the receiver

1. In the Home screen, press . Use the *Operation Mode* screen to configure system settings, mode settings, or to view the SV (satellite) status. Mode Settings is the default setting.
2. Press . Use the *Mode* screen to select whether the receiver will operate as a base or rover.
3. Press . When the mode begins to flash, the receiver is in Edit mode and you can change this setting.
4. Press  to change to Rover.
5. Press  to accept the change.
6. Press  again to move to the *Elevation mask and RTK mode* screen. See next.



Changing the elevation mask and RTK mode

1. Press . When the value for the current elevation mask begins to flash, the receiver is in Edit mode and you can change the setting.
2. Press  to change the elevation mask to the required value.

Note – Trimble recommends that you do not set the elevation mask to a value lower than 10 degrees.





3. Press  to accept the change.
4. Press .
5. In the *Mode* field, press . When the current mode begins to flash, the receiver is in Edit mode and you can change this setting.
6. Press  to change the desired RTK mode of the receiver.

The Mode setting is either RTK Sync or Low Latency. RTK Sync waits for the corresponding base data to arrive. It provides positions slightly more accurate than the Low Latency mode, however it increases latency and has a maximum update rate of 1 Hz. Trimble recommends that you use the Low Latency mode.

7. Press  to accept the change.
8. Press  again. The *Antenna Type* screen appears. See next.



Selecting the antenna

In the *Antenna Type* screen:

1. Press . When the antenna name begins to flash, the receiver is in Edit mode and you can select the type of antenna that is to be used with the receiver.
2. Press  to scroll through the antenna models.
3. Once the correct antenna name appears, press  to accept the change.
4. Press  again. The *NMEA* screen appears. See next.

Outputting corrections

In the *NMEA* screen, set up outputs from the receiver:















1. Press  to accept the default of no NMEA messages.
2. Use the *GSOF* screen to set up GSOF outputs from the receiver. Press  to accept the default of no GSOF messages.
3. Use the *RT17* screen to set up RT17 outputs from the receiver. Press  to accept the default of no RT17 messages. The Home screen appears, and the base setup is complete.

Configuring system settings

You can use the keypad and display of the receiver to configure the following settings:

- Display language
- Display and input units
- Baud rate, parity, data bits, and stop bits for serial ports
- Display power saver
- AutoBase warning
- Set position precisions

To access the system settings:











1. In the Home screen, press . Use the *Operation Mode* screen to configure system settings or mode settings, and to view the SV (satellite) status. Mode Settings is the default setting.
2. Press . When the operation mode begins to flash, the receiver is in Edit mode and you can change this setting.
3. Press  to change to System Setup.
4. Press  to accept the change.
5. Press  again.
6. Use the *Display Language* screen, if necessary, to change the language. Choose English, Finnish, French, German, Italian, Spanish, or Swedish. Press  to accept the change.
7. Press  again. Use the *Display and Input Units* screen, if necessary, to change the units to Meters or US Feet.
8. Press  to accept the change.
9. Press  again. Use the *Port Settings* screen, if necessary, to change the port.
10. Press  to accept the change.
11. Press  again. Use the *Screen Pwr Savr* screen to choose On, Off, or Auto. If you use the Auto setting, the screen turns off after 60 seconds of inactivity. The Power LED remains lit so that you can tell if the receiver is on or off. If an error message appears, the screen comes back on. Press  to accept the change and then press  again to move to the next screen.
12. If you are using an SPSx51 RTK base station, the *Autobase warning* screen appears. See [Chapter 8, Automatically Setting up a Mobile Base Station Using AutoBase Technology](#).
13. Press  to accept the change.
14. Press  again. When the Home screen appears, the system setup is complete.

Turning off AutoBase technology

You can turn off AutoBase technology using either the receiver's keypad and display or the web interface (see [Receiver Configuration menu, page 90](#)).

When AutoBase technology is off, you can establish a new base station position in the receiver using the *Edit Current* or *New Base (Here)* menus. This does not automatically generate a new application file, but changes the settings in the current application file. When the receiver is turned on again, the most recent settings are always used.

To turn off AutoBase technology using the receiver:

1. In the Home screen, press .
2. Press . When the operation mode begins to flash, the receiver is in Edit mode and you can change this setting.
3. Press  to change to System Setup.
4. Press  to accept the change.
5. Press  again. You start to scroll through options in the *System Setup* menu.
6. Keep pressing  until *Autobase* appears.
7. Press . The setting *On* flashes.
8. Press  until it displays *Off*. Press  to accept the change.
9. Press  again. The *Active Appfile* screen appears.

Note – If AutoBase is turned on, the *AutoBase Warning* screen appears.

To change the application file:

- Press  to display *START Appfile*.
- Press  to show *SAVE Appfile*.
- Press  to show *DELETE Appfile*.
- Press  to show *START Appfile*.

Managing application files

You can use the front panel to manage application files in the receiver. You can see which application file the receiver is currently using and then choose to make changes to it and save it, load a different application file, or delete an application file.

To manage the application files, use the *System Setup* menu (see [Figure 6.1](#)). You can only manage application files when the AutoBase feature is turned off.

To save an application file, configure all the settings you need through the front panel and then save the file. When you save the file, the receiver provides a default filename, which you can change, based on the currently set mode. For example:

If the receiver is set to the following mode:	The suggested application filename is:
Base	BASE01
Heading	HDG01
Moving Base	MB01
Rover	ROV01

Note – If you start an application file that is saved with AutoBase turned **on** in the file, then it turns **on** AutoBase in the receiver, even if it was off before the file was loaded.

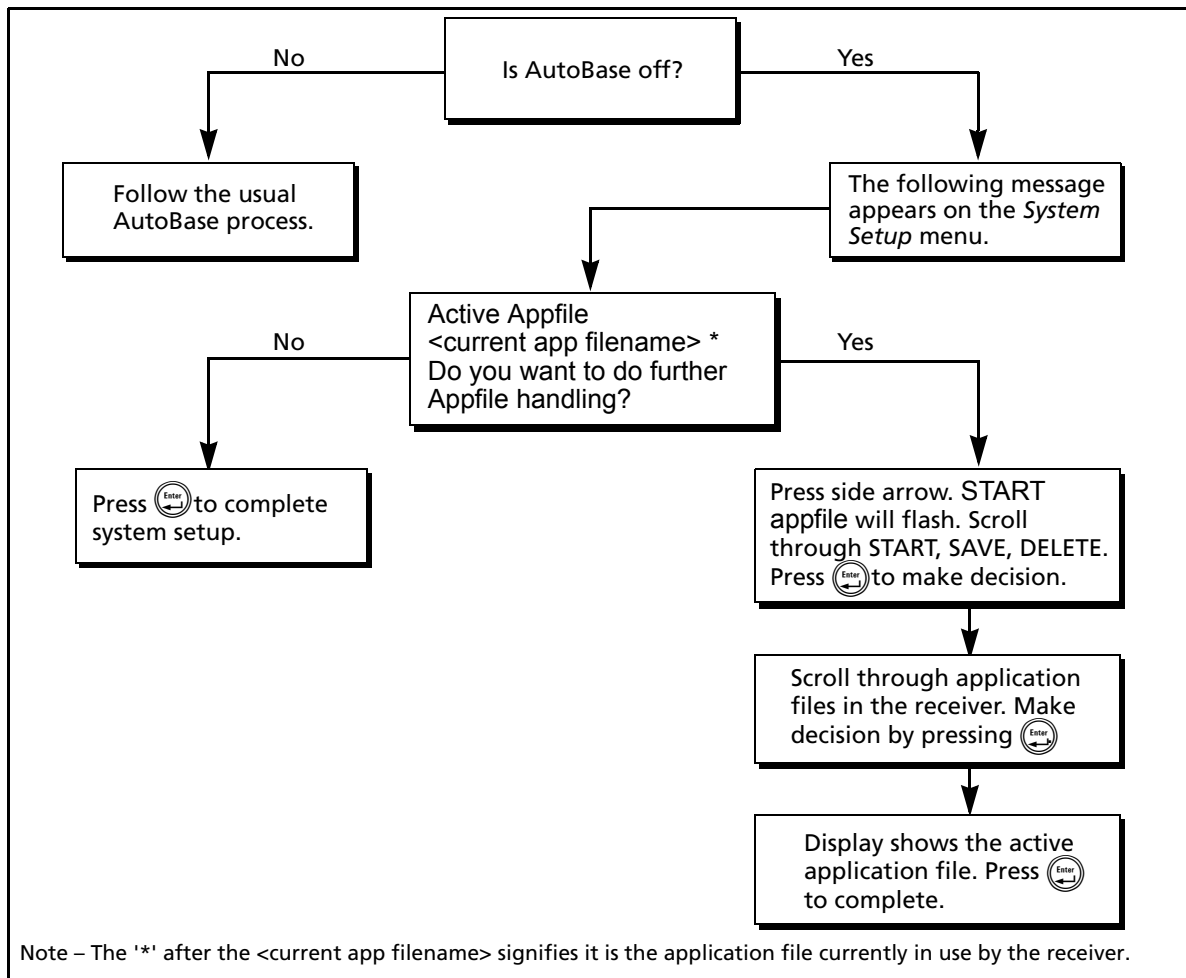

Figure 6.1 Application file handling through the front panel of the receiver

Configuring the Receiver Settings

In this chapter:

- Using the SCS900 Site Controller software to configure the base station, the rover, and the radios
- Configuring the receiver to log data for postprocessing
- Configuring the receiver to use specific settings when it is turned on
- Configuring Ethernet settings
- Configuring the receiver using a web browser

You can configure the SPS GPS receiver family in a variety of ways. This chapter describes the different configuration methods, and explains when and why each method is used.

The SCS900 Site Controller software is likely to be your main tool to set up and operate the receiver on a daily basis. All necessary field configurations are handled through the SCS900 software running on a TSC2 or Trimble CU controller. For more information, refer to the *Trimble SCS900 Site Controller Software Office Guide*.

The external software detailed in this chapter is primarily used to update the receiver firmware and to configure upgrades or radio channels.

Using the SCS900 Site Controller software to configure the base station, the rover, and the radios

As part of a total system solution for construction applications, the SPS GPS receivers are operated by a TSCe, ACU, TCU, or TSC2 controller running the SCS900 Site Controller software. The SCS900 Site Controller software provides the tools to configure and start the GPS receiver in the modes used by the SCS900 system: RTK Base Station, RTK Rover, DGPS Rover, OmniSTAR rover, SBAS Rover (using WAAS/EGNOS/MSAS). Wizards help you through the process and, where possible, assign suitable default operational parameters to the system. This eliminates the need for an operator to know how to configure the receiver with the right settings.

The SCS900 Site Controller software manages:

- the radio, whether internal or external
- all cellular communications components, such as modems and cell phones
- the use of the Bluetooth wireless technology

The software also scans communication ports on the receiver to identify connected devices. If the software cannot automatically identify the connected component, for example, a GPS antenna, it offers options (often with graphics) to help you manually select the correct component.

The SCS900 Site Controller software allows you to set operational tolerances and settings (such as those shown below), which must be achieved before measurements can be accepted. When outside of these tolerances, the SCS900 Site Controller software warns you through on-screen messages or indications, and the non-automatic acceptance of recorded positions. To set operational tolerances, go to the *Settings* menu in the SCS900 Site Controller software.

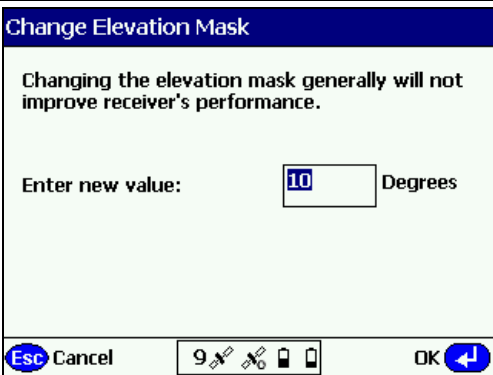

Example 1: From the Sky Plot screen, press Ctrl+M to open this screen and change the angle below which the receiver will not track satellites

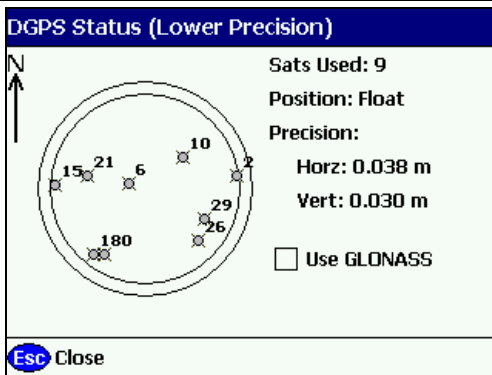

Example 2: Use the Sky Plot screen to set if the receiver will track GLONASS satellites

Configuring the receiver to log data for postprocessing

The receivers do not come equipped with the Data Logging option. The receivers can have this added either at the time of purchase, or at a later date as an option. With the Data Logging option enabled, the receiver has available memory that facilitates the collection of GPS observations over a period of time, and that can be used with GPS postprocessing software such as the Trimble Geomatics Office™ for the computation of control networks and baselines.

Note – Version 2.30 and later of the SCS900 software supports the recording of raw GPS data in the SPS receivers when the Data Logging option is installed in the receiver. For information on how to initiate recording in the SPS receivers from SCS900, refer to the SCS900 Precision GPS User Guide.

Configuring the receiver to use specific settings when it is turned on

The power up application file (Power_up.cfg) is used to set the receiver to a specific configuration any time the unit is powered up.

In this file, you can specify that the receiver is reset to defaults before the power up settings are applied. This ensures that restarting the receiver always resets it to factory defaults prior to applying the power up application file.

Alternatively, you can specify that the power up settings are applied immediately after the current application file's settings have been applied. Restarting the receiver results in a configuration that uses your default settings for the options you define in the power up file, but the current settings for all other options.

By default, there is no power_up application file on the receiver. To use a power up application file, you must create and save a power_up application file in the GPS Configurator software. If you save this file to disk, the file is called power_up.cfg. The extension .cfg is used, by convention, to identify application files on the office computer. When you transfer this file to the receiver, the file is saved on the receiver as power_up, and becomes the new power up file.

Configuring Ethernet settings

The receiver has an Ethernet port so that the receiver can connect to an Ethernet network. You can use the Ethernet network to access, configure, and monitor the receiver. No serial cable connection to the receiver is necessary.

The receiver requires the following Ethernet settings:

- IP setup: Static or DHCP
- IP address
- Netmask
- Broadcast
- Gateway
- DNS address
- HTTP port

The default setting for the HTTP port is 80. The HTTP port is not assigned by the network. HTTP port 80 is the standard port for web servers. This allows you to connect to the receiver by entering only the IP address of the receiver in a web browser. If the receiver is set up to use a port other than 80, you will need to enter the IP address followed by the port number in a web browser.

Example of connecting to the receiver using port 80: `http://169.254.1.0`

Example of connecting to the receiver using port 4000: `http://169.254.1.0:4000`

The default setting of the receiver is to use DHCP. Using DHCP enables the receiver to automatically obtain the IP address, Netmask, Broadcast, Gateway, and DNS address from the network.

When a receiver is connected to a network using DHCP, the network assigns an IP address to the receiver. To verify the IP address, select the up button from the keypad when the Home screen is displayed. The Ethernet IP address appears. The screen shown is of a receiver that has failed to get an IP address.

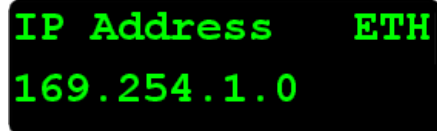

The screenshot shows a black background with green text. The text is arranged in two lines. The first line contains 'IP Address' followed by 'ETH' on the right. The second line contains the IP address '169.254.1.0'.

If your network installation requires the receiver to be configured with a static IP address, you can configure the Ethernet settings using the web server or the WinFlash utility. The web server can be used only when the receiver is connected to a network and has a valid Ethernet configuration. When DHCP fails, the receiver uses a private IP.

Use the WinFlash utility to configure the Ethernet settings of a receiver that is to be connected to a network that requires static IP addresses:

1. Contact the network administrator for the correct settings for the receiver.
2. Connect the receiver to a computer running the WinFlash utility using the serial cable provided with the receiver.
3. Turn on the receiver.
4. On the computer, start the WinFlash utility.

5. From the *Device Configuration* screen, select the Trimble SPSx51 Receiver. From the *PC serial port* list, select the appropriate PC serial port. Click **Next**:

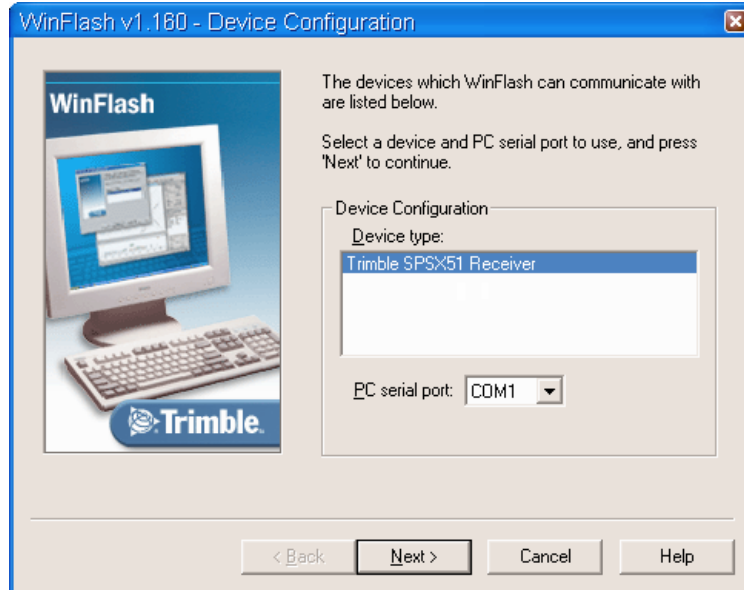

6. From the *Operation Selection* screen, select Configure ethernet settings, and then click **Next**:

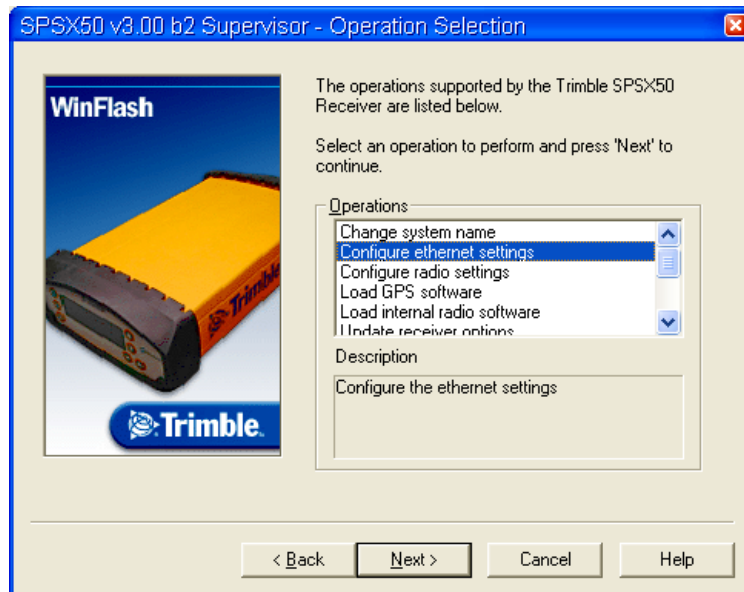

7. From the *Settings Review* screen, click **Finish**:

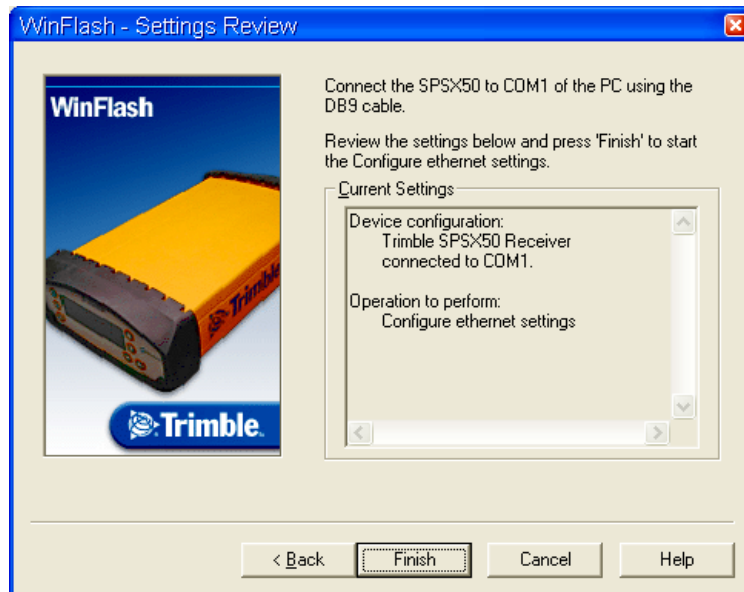

Once the WinFlash utility connects to the receiver, the *Ethernet Configuration* dialog appears.

8. Enter the network settings in the *Ethernet Configuration* dialog. Click **OK**:

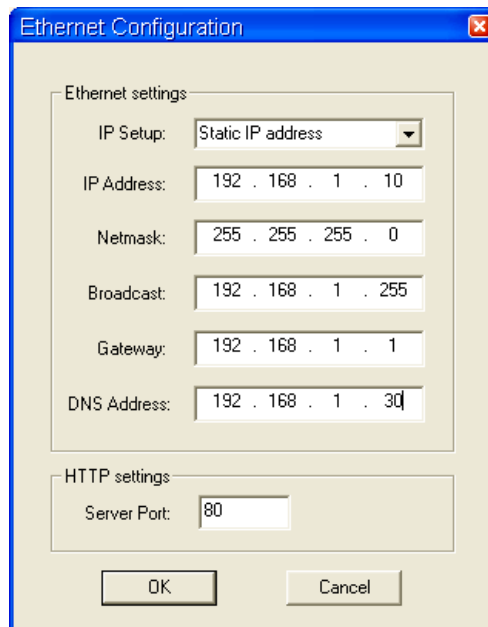

The Broadcast setting is the IP address that is used to broadcast to all devices on the subnet. This is usually the highest address (usually 255) in the subnet.

Configuring the receiver using a web browser

The receiver can be configured using the keypad and display, Trimble SCS900 Site Controller software, or a web browser. This section describes how to set up the receiver using a web browser.

Supported browsers

- Mozilla Firefox version 1.07 or later (version 1.50 or later is recommended for Windows, Macintosh, and Linux operating systems)
- Microsoft Internet Explorer® version 6.00 or later for Windows operating systems

Connecting to the receiver using a web browser:

1. Enter the IP address of your receiver into the address bar of the web browser as shown:



2. If security is enabled on the receiver, the web browser prompts you to enter a username and password:

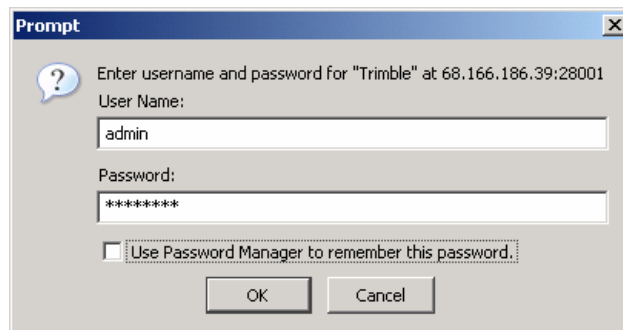

The default login values for the receiver are:

- User Name: admin
- Password: password

If you cannot connect to the receiver, the password for the admin account may have been changed, or a different account may be in use. Contact your receiver administrator for the appropriate login information.

Connecting to the receiver using a web browser and Bluetooth wireless technology

This section describes how to access the web interface on a SPSx51 Modular GPS receiver that has firmware version 3.32 or later installed, using Bluetooth wireless technology on an office computer that has Service Pack 2 of the Windows XP operating system (Professional Edition) installed.

1. On the office computer, open the Control Panel. Open Bluetooth Configuration and go to the *Client Applications* tab. The following dialog appears:

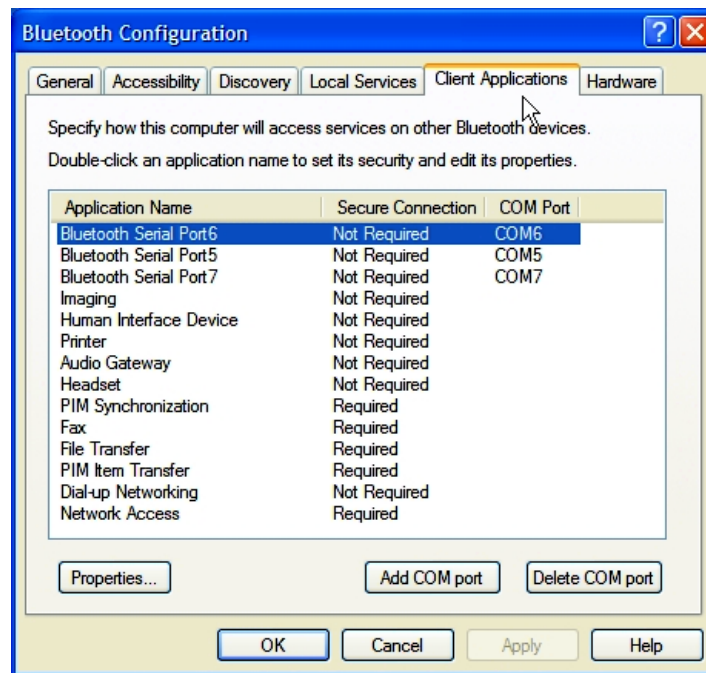

2. Add at least one Bluetooth Serial port. To do this, click **Add COM port** and then follow the steps through the wizard. Name the COM port appropriately and clear the *Secure Connection* check box.

3. Start the *Bluetooth Setup* wizard (click *Start / All Programs / My Bluetooth Places*):

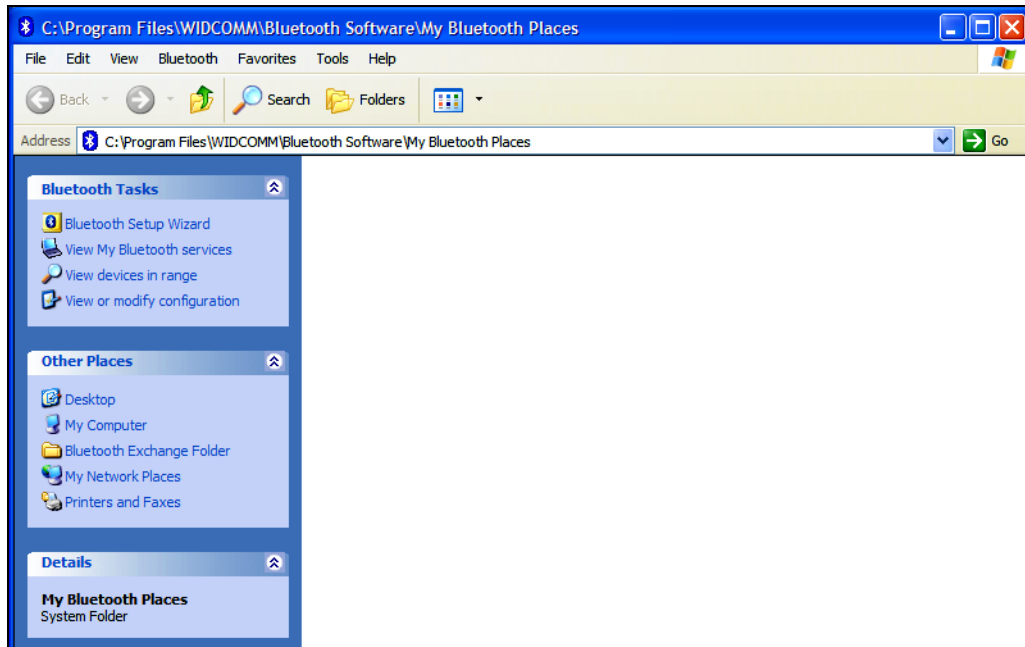

4. The *Bluetooth Setup* wizard starts. Use the settings shown below and then click **Next**:



The following dialog appears:

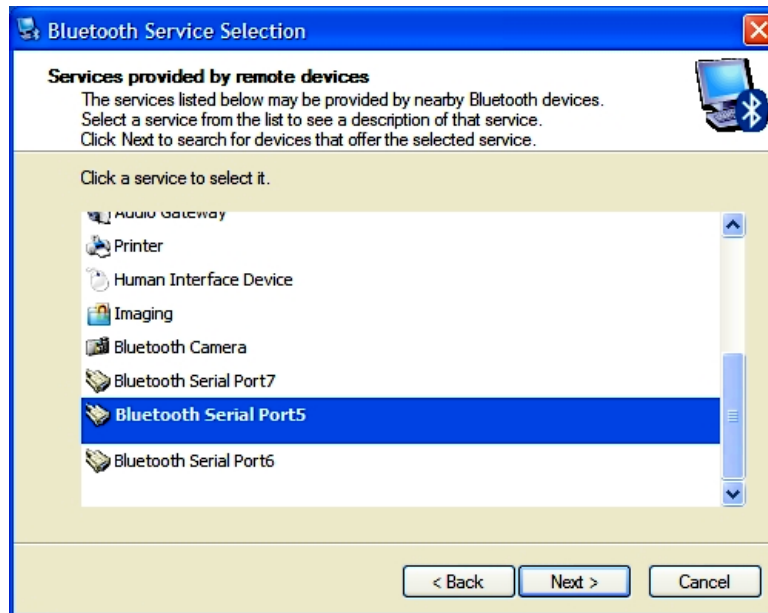

5. Select the Bluetooth serial port you created and then click **Next**. The following dialog appears:



6. In the Search criteria list, change the search to Show all devices and then select the modular GPS receiver that you want to connect to. Click **Next**.

The following dialog appears:



7. Click **Configure** to select the COM port on your office computer. Think of Bluetooth as a cable replacement and this as the serial port on your office computer into which the Bluetooth 'cable' will be connected. The following dialog appears:

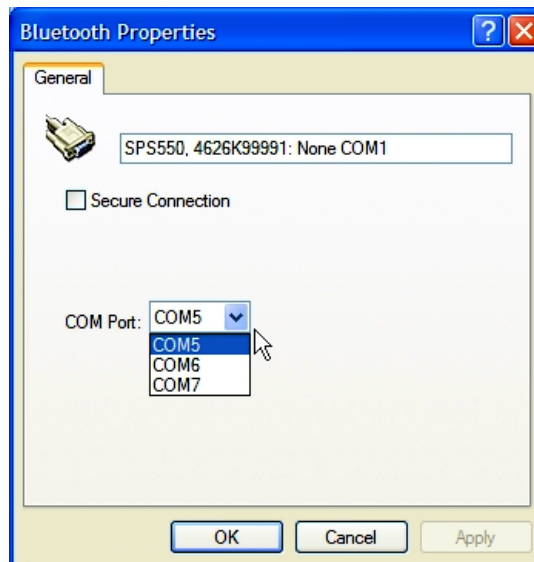

8. Ensure that the *Secure Connection* check box is cleared and then tap **OK**.
9. Tap **Finish**. The new Bluetooth connection appears in My Bluetooth places.

- Double-click this icon to connect:

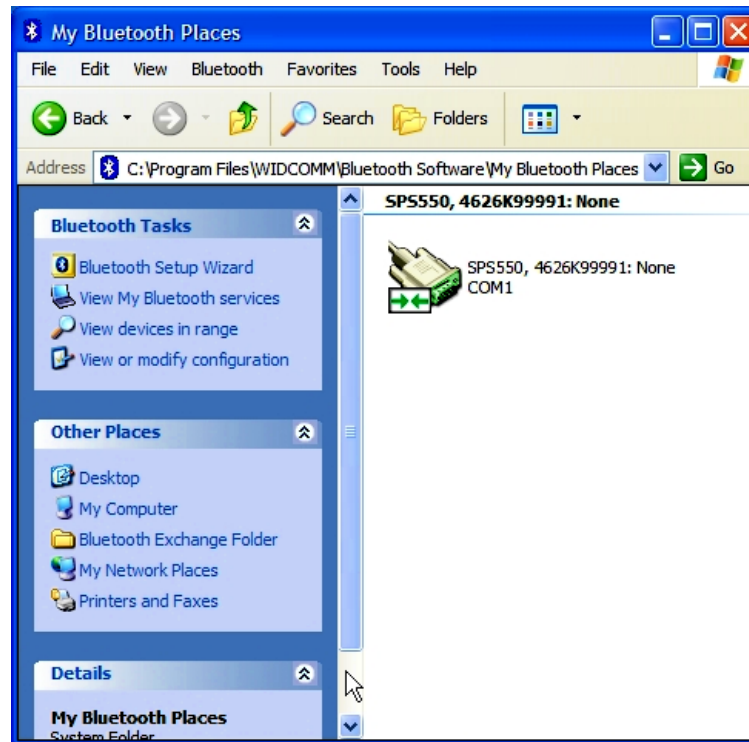

Creating a new connection

- From your Windows Control Panel, open Network Connections and then click **Create a new connection**:

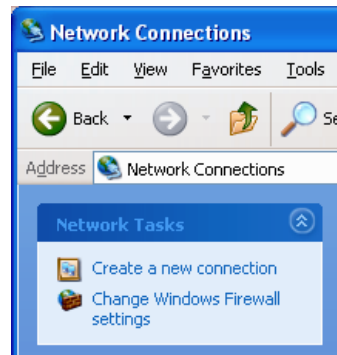

- The *New Connection* wizard starts. Complete the wizard using the following settings:
 - Set up an advanced connection
 - Connect directly to another computer

- Guest



3. Give the connection a name which relates to the COM port being used on the office computer. This is like a cable connection between two computers only the cable is being replaced by a Bluetooth wireless connection. Tap **Next**. The following dialog appears:

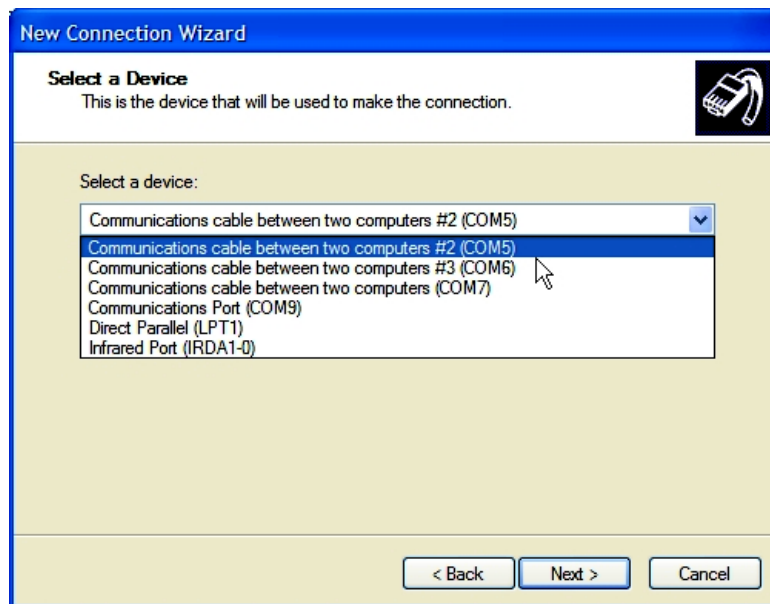

4. Select the correct COM port from the list and then tap **Next**. The following dialog appears:



5. Enter the user name and password and then click **Connect**.
The defaults for the SPSx51 receiver are:
Username: admin
Password: password
6. The new Direct connection appears in the Network Connections folder. If that status shows as Connected, you can continue to the web interface.

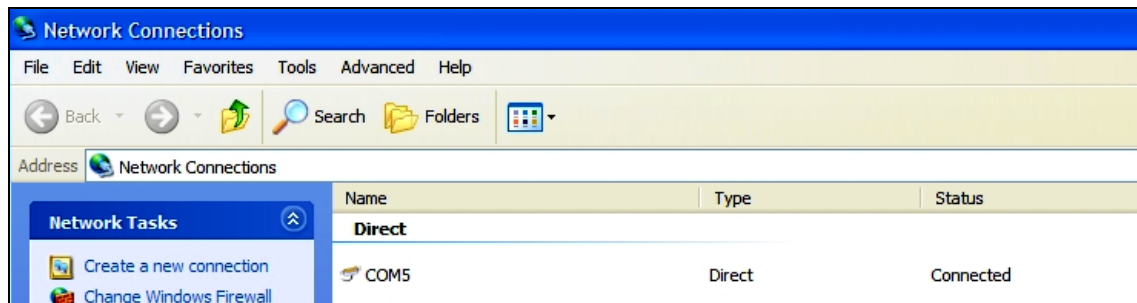

7. Right-click on the connection and select Status:

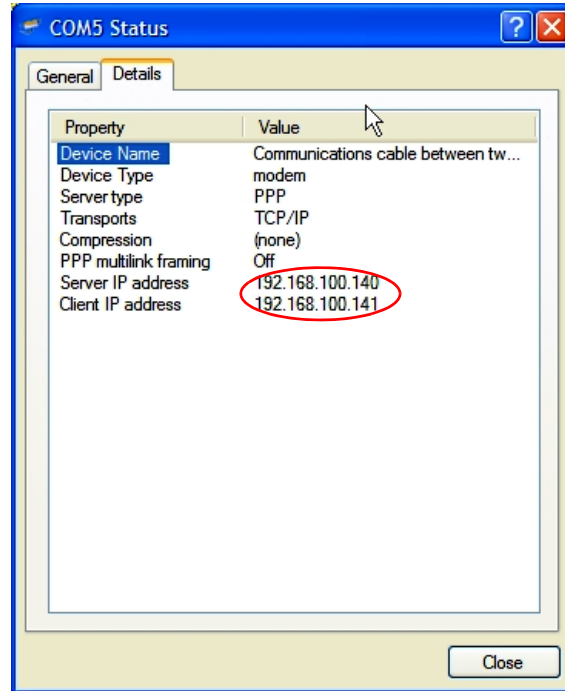

8. The *Details* tab shows the Server IP address. Use this IP to connect to the receiving using the web interface.



Tip – You can also get the PPP address from the front panel of the receiver by pressing  from the Home screen.

Menus

Once you are logged in, the home page appears (see [Figure 7.1](#)).

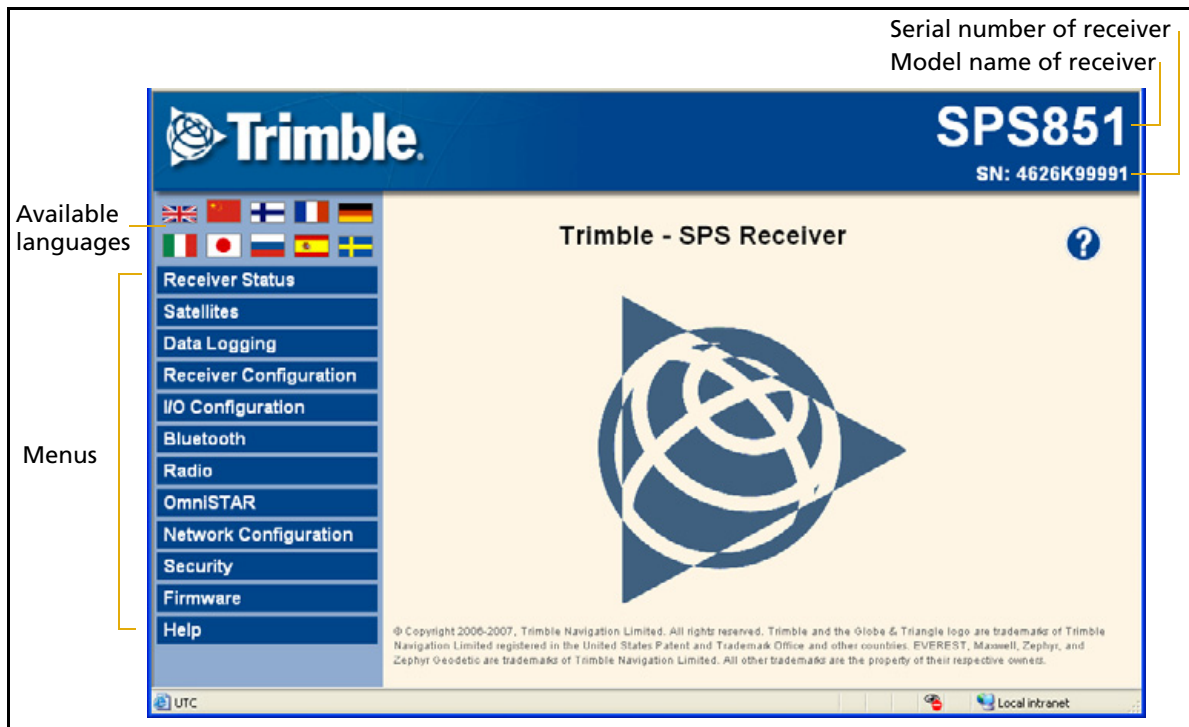

Figure 7.1 SPS GPS receiver Home page

Changing the settings

Use the webpage to configure the receiver settings. The web interface shows the configuration menus on the left of the browser window, and the settings on the right. Each configuration menu contains related submenus to configure the receiver and monitor receiver performance.

Note – The configuration menus available vary based on the version of the receiver.

A summary of each configuration menu is provided here. For more detailed information about each of the receiver settings, select the *Help* menu. The Help is available whenever your computer is connected to the Internet. It is also available anytime from the Trimble website (www.trimble.com/EC_ReceiverHelp/v3.60/en).

To display the web interface in another language, click the corresponding country flag. The web interface is available in the following languages:

- English (en)
- Chinese (zh)
- Finnish (fi)
- French (fr)
- German (de)
- Italian (it)
- Japanese (ja)
- Russian (ru)
- Spanish (es)
- Swedish (sv)

Receiver Status menu

The *Receiver Status* menu provides a quick link to review the receiver's available options, current firmware version, IP address, temperature, runtime, satellites tracked, current outputs, available memory, position information, and more.

This figure shows an example of the screen that appears when you select *Receiver Status / Identity*.



Satellites menu

Use the *Satellites* menu to view satellite tracking details and enable/disable GPS, GLONASS, and SBAS (WAAS/EGNOS and MSAS) satellites.

Note – To configure the receiver for OmniSTAR, use the *OmniSTAR* menu. See [page 94](#).

This figure shows an example of the screen that appears when you select *Satellite / Tracking (Sky Plot)*.

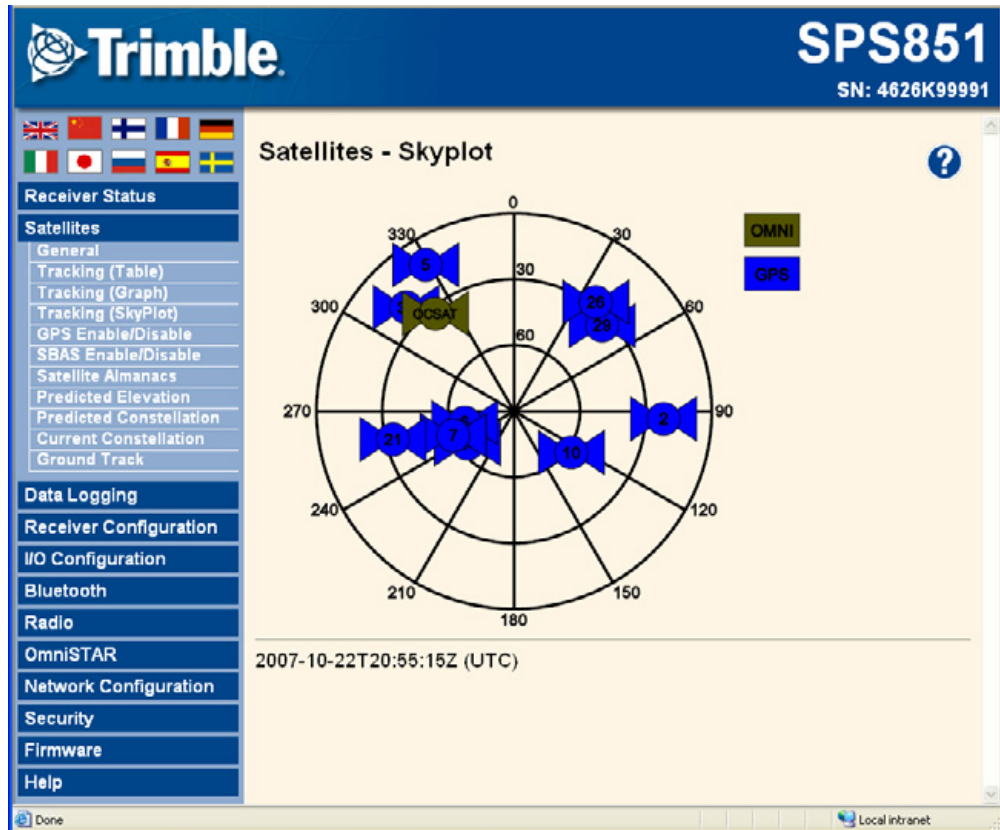

Data Logging menu

Use the *Data Logging* menu to set up the receiver to log static GPS data. This menu is available only if the receiver has the Data Logging option enabled. You can also configure settings such as observable rate, position rate, continuous logging, continuous logging rate, and whether to auto delete old files if memory is low.

This figure shows an example of the screen that appears when you select *Data Logging / Configuration*.

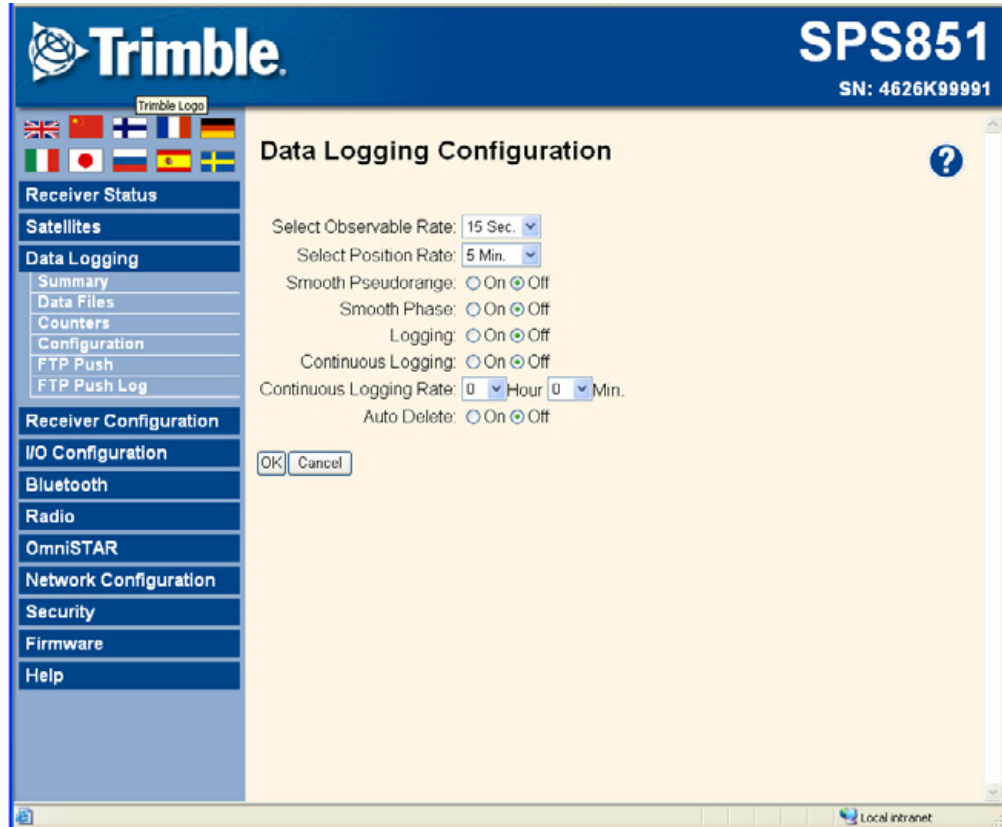

Receiver Configuration menu

Use the *Receiver Configuration* menu to configure such settings as elevation mask and PDOP mask, the antenna type and height, the reference station position, and the reference station name and code.

This figure shows an example of the screen that appears when you select *Receiver Configuration / Summary*.

Trimble SPS851
SN: 4626K99991

Receiver Configuration

Receiver Status	Elevation Mask:	10"
Satellites	PDOP Mask:	7
Data Logging	Horizontal Precision:	0.30 [m]
Receiver Configuration	Vertical Precision:	0.30 [m]
Summary	Clock Steering:	Disabled
Masks	Everest™ Multipath Mitigation:	Enabled
Antenna	Antenna ID:	185
Reference Station	Antenna Type:	Zephyr Geo Mdl 2
Advanced Settings	Antenna Height:	0.000 [m]
Application Files	RTK Mode:	Low Latency
Reset	Motion:	Kinematic
Default Language	CMR Input Filter:	Disabled
I/O Configuration	Reference Latitude:	0°0'00.00000"N
Bluetooth	Reference Longitude:	0°0'00.00000"E
Radio	Reference Height:	0.000 [m]
OmniSTAR	RTCM 2.x ID:	0
Network Configuration	RTCM 3.x ID:	0
Security	CMR ID:	0
Firmware	Station Name:	CREF0001
Help	Ethernet IP:	10.3.16.117
	System Name:	99991
	DNS Resolved Name:	NONE
	Serial Number:	4626K99991
	Firmware Version:	0.17
	Firmware Date:	2007-10-15

UTC Local intranet

I/O Configuration menu

Use the *I/O Configuration* menu to set up all outputs of the receiver. The receiver can output CMR, RTCM, NMEA, GSOF, or BINEX messages. These messages can be output on TCP/IP, UDP, serial, Bluetooth, or radio ports.

This figure shows an example of the screen that appears when you select *I/O Configuration / Port Summary*.

The screenshot displays the Trimble SPS851 I/O Configuration menu. The top header includes the Trimble logo, the model number SPS851, and the serial number SN: 4626K99991. A sidebar on the left contains navigation options: Receiver Status, Satellites, Data Logging, Receiver Configuration, I/O Configuration (selected), Bluetooth, Radio, OmniSTAR, Network Configuration, Security, Firmware, and Help. The I/O Configuration section is further divided into Port Summary and Port Configuration. The Port Summary table is as follows:

Type	Port	Input	Output
TCP/IP	5017	-	-
TCP/IP	5018	-	-
NTripClient	-	-	-
NTripServer	-	-	-
NTripCaster 1	8000	-	-
NTripCaster 2	8001	-	-
NTripCaster 3	8002	-	-
Serial	Lemo (38.4K-8N1)	-	-
Serial	Modem 1 (38.4K-8N1)	-	-
Serial	Modem 2 (38.4K-8N1)	-	-
Bluetooth	1	-	-
Bluetooth	2	-	-
Bluetooth	3	-	-
USB	-	-	-
Radio	-	-	-
CAN	-	-	-

The bottom of the screen shows a status bar with the text "javascript:parent.loadDataFrame('xml/ioConfigDisplay.html?') Local intranet".

Bluetooth menu

Use the *Bluetooth* menu to configure the receiver to connect to other devices that use Bluetooth wireless technology. These devices can be used to configure the receiver, and generate or receive corrections. The following Trimble devices can be connected to an SPSx51 receiver using Bluetooth wireless technology:

- TSC2 controller
- TCU controller
- TSCe controller
- ACU controller
- SNB900 radio-modem
- Other Bluetooth-enabled SPS GPS receivers

This figure shows an example of the screen that appears when you select *Bluetooth / Info*.

The screenshot displays the Trimble SPS851 configuration interface. The top header shows the Trimble logo and the device model 'SPS851' with serial number 'SN: 4626K99991'. A language selection bar is visible below the header. The left sidebar contains a menu with options: Receiver Status, Satellites, Data Logging, Receiver Configuration, I/O Configuration, Bluetooth (selected), Radio, OmniSTAR, Network Configuration, Security, Firmware, and Help. The Bluetooth menu is expanded to show 'Info', 'Configuration', and 'Remotes'. The main content area is titled 'Bluetooth Info' and contains a table with the following data:

Module Info	Infineon LM-FW version: 7.50 BB-FW version: 055b
Stack Version	1.21.1.2/2.0
Local Name	SPS851, 4626K99991: 99991
Bluetooth MAC Address	00:80:37:27:1b:46
Discoverable	True
Pin Code	0000

The bottom status bar shows 'Done' on the left and 'Local intranet' on the right.

Radio menu

Use the *Radio* menu to configure the internal radio of the receiver, if applicable. The receivers are available with 410–430 MHz, 430–450 MHz, 450–470 MHz, or 900 MHz radios. The SPS551H receiver **does not** have an internal radio.

This figure shows an example of the screen that appears when you select *Radio*.



OmniSTAR menu

All receivers, except the SPS551H, can receive OmniSTAR corrections. By default, OmniSTAR tracking is turned on in the receiver. To receive OmniSTAR corrections, you must set the receiver to track OmniSTAR satellites and it must have a valid OmniSTAR subscription. To purchase a subscription for your receiver, contact OmniSTAR at:

www.OmniSTAR.com

North & South America, 1-888-883-8476 or 1-713-785-5850

Europe & Northern Africa, 31-70-317-0900

Australia & Asia, 61-8-9322 5295

Southern Africa, 27 21 552 0535

This figure shows an example of the screen that appears when you select *OmniSTAR / Summary*.

The screenshot shows the Trimble SPS851 receiver's user interface. The top bar features the Trimble logo and the model number SPS851 with the serial number SN: 4626K99991. A language selection menu is visible on the left, showing flags for various countries. The main content area is titled 'OmniSTAR Summary' and contains a table of performance metrics. A sidebar on the left lists various configuration options, with 'OmniSTAR Summary' currently selected.

OmniSTAR Summary	
SV name	Auto/OCSAT
Frequency [MHz]	1535.1850
Bit Rate [Hz]	1200
Setting	Auto
Mode	Tracking
SNR (Eb/No)	8.39
Total messages	1208
Bad messages	0
Total unique word bits	77376
Bad unique word bits	33

Network Configuration menu

Use the *Network Configuration* menu to configure Ethernet settings, email alerts, PPP connection, HTTP port, FTP port, and VFD port settings of the receiver. For information on the Ethernet settings, see [Configuring Ethernet settings, page 74](#).

The VFD port allows you to use the SPSx51 Remote Control application to view and navigate the receiver through a mock display and keypad interface. To allow the SPSx51 Remote Control to connect to the receiver, you need to enable the VFD port. To do this, select *Network Configuration / VFD*.

This figure shows an example of the screen that appears when you select *Network Configuration / Ethernet*.

Trimble SPS851
SN: 4626K99991

Ethernet Configuration

Stored settings

IP Setup: DHCP

IP Address: 10 . 3 . 16 . 117

Netmask: 255 . 255 . 252 . 0

Broadcast: 10 . 3 . 19 . 255

Gateway: 10 . 3 . 16 . 1

DNS Address: 10 . 3 . 0 . 124

DNS Domain: ap.trimblecorp.net

Hostname: trim4626k99991

MTU: 1500

OK

Current settings

IP Setup: DHCP

IP Address: 10.3.16.117

Netmask: 255.255.252.0

Broadcast: 10.3.19.255

Gateway: 10.3.16.1

DNS Address: 10.3.0.124

DNS Domain: ap.trimblecorp.net

Hostname: trim4626k99991

MTU: 1500

Security menu

Use the *Security* menu to configure the login accounts for all users who will be permitted to configure the receiver using a web browser. Each account consists of a username, password, and permissions. Administrators can use this feature to limit access to other users. Security can be disabled for a receiver. However, Trimble discourages this as it makes the receiver susceptible to unauthorized configuration changes.

This figure shows an example of the screen that appears when you select *Security / Configuration*.

Trimble SPS851
SN: 4626K99991

Security Configuration

Security:

Delete?	Username	Edit User	File Download	File Delete	Receiver Config	NTripCaster
<input type="checkbox"/>	admin	<input checked="" type="checkbox"/>	<input checked="" type="checkbox"/>	<input checked="" type="checkbox"/>	<input checked="" type="checkbox"/>	<input checked="" type="checkbox"/>

Add User?

Username:

Password:

Verify Password:

Edit User	File Download	File Delete	Receiver Config	NTripCaster
<input type="checkbox"/>	<input type="checkbox"/>	<input type="checkbox"/>	<input type="checkbox"/>	<input type="checkbox"/>

Firmware menu

Use the *Firmware* menu to verify the current firmware and load new firmware to the receiver. You can upgrade firmware across a network or from a remote location without having to connect to the receiver with a serial cable.

This figure shows an example of the screen that appears when you select *Firmware*.



Help Menu

The *Help* menu provides information on each of the receiver settings available in a web browser. Selecting the *Help* menu opens new windows. Select the section of the Help that you want to view. The Help files are stored on the Trimble Internet site (www.trimble.com/EC_ReceiverHelp/v3.60/en (For languages other than English, replace **en** with the appropriate two-letter country code (see [page 86](#))) and are updated between firmware releases.

To access the Help, your computer must be connected to the Internet. If you do not have access to the Internet, there is also a copy of the receiver Help files on the *Trimble SPS GPS Receiver CD*. (This copy shows the Help files as they were when the CD was published.)

This figure shows an example of the screen that appears when you select *Help*.

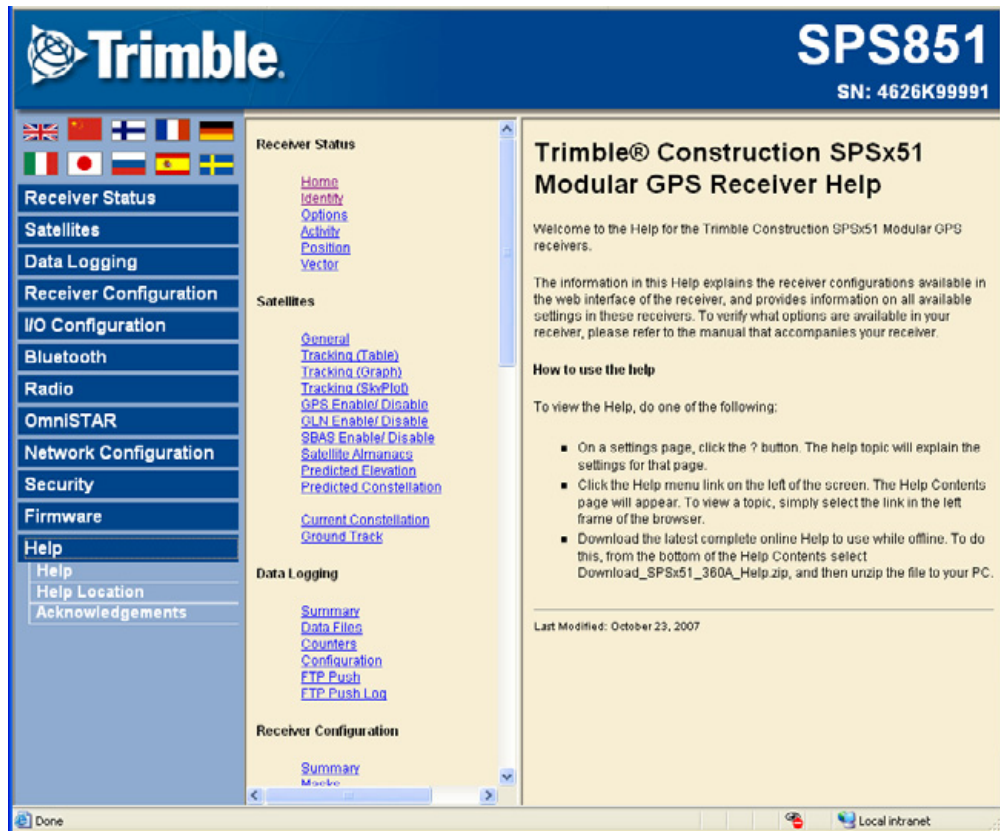

Automatically Setting up a Mobile Base Station Using AutoBase Technology

In this chapter:

- AutoBase Warning
- Working with AutoBase technology
 - Scenario One: First visit to a site with AutoBase Warning turned off
 - Scenario Two: First visit to a site with AutoBase Warning turned on
 - Scenario Three: Repeat visit to a site with AutoBase Warning turned off
 - Scenario Four: Repeat visit to a site with AutoBase Warning turned on
- The AutoBase process

The AutoBase technology is a feature of the Trimble receivers that enables you to reduce daily setup time for mobile base stations and to reduce the likelihood of using incorrect base station coordinates during setup.

The AutoBase feature allows you to set up a receiver as a base station receiver and save you time so you do not need to reconfigure the receiver at the start of each day. It also allows you to set up the base station on a new site without needing to configure the settings in the receiver.

Even if you have used the AutoBase feature in other Trimble receivers, Trimble recommends that you read this chapter carefully because new functions in this feature provide greater benefit to you.

***Note** – For information about turning AutoBase off using the receiver, see [Chapter 6, Configuring the Receiver Using the Keypad and Display](#).*

AutoBase Warning

The AutoBase Warning, when enabled, prevents the receiver from creating a new base station position and begin operating as an RTK base station when no previous base station position exists that corresponds to the current position of the receiver.

When the AutoBase Warning is on, the receiver will not begin transmitting RTK corrections from a base position (latitude, longitude, and height) that is not a part of the GPS site calibration. When the AutoBase Warning is off, the receiver begins transmitting RTK corrections from a new base position. You need only turn on the receiver the first time on a point, and you do not need to manually configure the base station settings.

By default, the receivers have the AutoBase Warning turned on. The receiver uses the AutoBase Warning setting to control how the receiver performs when different criteria are met. You can turn the AutoBase Warning on or off using the keypad and display. For more information, see [Configuring system settings, page 68](#).

Working with AutoBase technology

This section contains some example scenarios. In each section, there is a step-by-step process that explains what you will experience in each scenario.

Scenario One: First visit to a site with AutoBase Warning turned off

The following actions occur when you set up the base station for the first time on a new point and the AutoBase Warning is turned off:

1. The receiver is powered on.
2. The receiver begins tracking satellites.
3. The receiver determines the current position.
4. The receiver reviews the previous base station positions stored in the receiver.
5. The receiver does not find any base station that corresponds to the current position.
6. The receiver creates a new base station location for the current location.
7. The receiver sets the antenna height to 0. The antenna height is measured to the bottom of the antenna mounting.



CAUTION – On each reoccupation of the point, you must ensure that the receiver antenna is set up in exactly the same location and at exactly the same height. Trimble also recommends that you use a T-bar or Fixed height tripod so that the position is easy to re-establish. Failure to achieve the same height position for the antenna results in errors in heights in subsequent measurements.

Where you set up each time with potentially different antenna heights, Trimble recommends that on the first setup after AutoBase has completed its process, that you edit the antenna height (using the receiver keypad and display). The updated antenna height changes the AutoBase setup, so that on subsequent setups, when you again change the antenna height, you will get correct height information during measurement. At the first setup, Trimble recommends that you change the AutoBase setup and antenna height *before* you carry out a site calibration.

8. The receiver begins generating RTK CMR+ corrections.
9. The RTK corrections begin streaming over the internal radio. If there is no internal radio, the receiver defaults to streaming the corrections on the Lemo port.

Scenario Two: First visit to a site with AutoBase Warning turned on

The following actions occur when you set up the base station for the first time on a point, and the AutoBase Warning is turned on:

1. The receiver is powered on.
2. The receiver begins tracking satellites.
3. The receiver determines the current position.
4. The receiver reviews the base positions stored in the receiver.
5. The receiver does not find any base station that corresponds to the current position.
6. The receiver displays a warning that AutoBase has failed.
7. No RTK corrections are streamed until the base station is set up using the keypad and display or an SCS900 controller.

Scenario Three: Repeat visit to a site with AutoBase Warning turned off

The following actions occur when you repeat a base station setup on a point, and the AutoBase Warning is turned off:

1. The receiver is powered on.
2. The receiver begins tracking satellites.
3. The receiver determines the current position.
4. The receiver reviews the base station positions stored in the receiver.
5. The receiver finds a base station position that corresponds to the current position.



CAUTION – If there are two or more base positions within a 50 meter radius of your current position, the receiver will make the most recently used base position file active.

6. The antenna type, antenna height and measurement method used in the previous setup of this base station are applied.



CAUTION – If the antenna height is different to the previous setup, then you must enter the corrected height for the antenna (using the keypad and display) before starting measurements. Failure to achieve the correct antenna height position for the antenna results in errors in heights in subsequent measurements.

7. The receiver begins sending RTK CMR+ messages.
8. The RTK corrections begin streaming on the radio or Lemo port in the application file.

Scenario Four: Repeat visit to a site with AutoBase Warning turned on

The following actions occur when you repeat a base station setup on a point, and the AutoBase Warning is turned on:

1. The receiver is powered on.
2. The receiver begins tracking satellites.
3. The receiver determines the current position.
4. The receiver reviews the base station positions stored in the receiver.
5. The receiver finds a base station position that corresponds to the current position.



CAUTION – If there are two or more base positions within a 50 meter radius of your current position, the receiver will make the most recently created base position file active.

6. Since a base station position is found, the AutoBase warning does not appear.
7. The receiver loads the previous base information.
8. The antenna type, antenna height, and measurement method used in the previous setup of this base station are applied.



CAUTION – If the antenna height is different from the previous setup, then you must enter the corrected height for the antenna (using the keypad and display) before starting measurements. Failure to achieve the correct antenna height position for the antenna results in errors in heights in subsequent measurements.

9. The receiver begins generating RTK CMR+ corrections.
10. The RTK corrections begin streaming on the radio or port defined in the previous setup of this base station.

Note – AutoBase recalls base station positions that are stored in the receiver. If the receiver has been previously set up on a control point but the stored base station position is not found in the receiver, it is possible that the information may have accidentally been deleted. In this case, use the display and keypad or the SCS900 system to manually set up the base

station. Make sure that you use the same base station latitude, longitude, and height as in the previous setup otherwise you will experience position or height errors in all subsequent measurements.

Trimble recommends that after any new base station setup, or at the start of each measurement session, you measure a known point to verify that position and height errors are within tolerance. This is good practice and it takes just a few seconds to eliminate potentially gross errors typically associated with repeated daily base station setups.

The AutoBase process

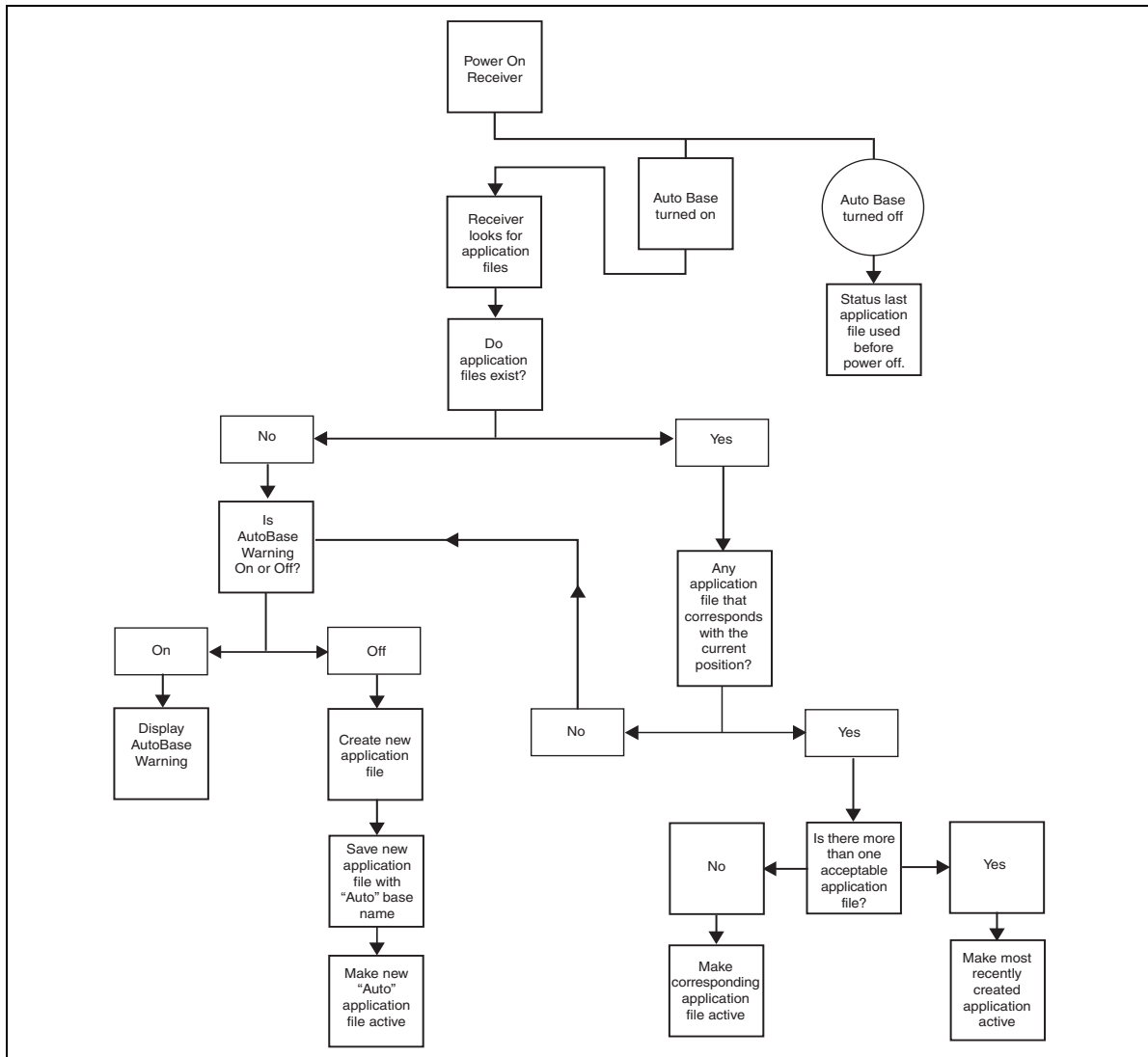

Figure 8.1 Autobase process flowchart

Default Settings

In this chapter:

- [Default receiver settings](#)
- [Resetting the receiver to factory defaults](#)
- [Data Logging option](#)

All settings are stored in application files. The default application file, `Default.cfg`, is stored permanently in the receiver, and contains the factory default settings. Whenever the receiver is reset to its factory defaults, the current settings (stored in the current application file, `Current.cfg`) are reset to the values in the default application file.

Default receiver settings

These settings are defined in the default application file.

Function		Factory default
SV Enable		All SVs enabled
General Controls:	Elevation mask	10°
	PDOP mask	7
	RTK positioning mode	Low Latency
	Motion	Kinematic
Lemo Port:	Baud rate	38,400
	Format	8-None-1
	Flow control	None
Modem Port:	Baud rate	38,400
	Format	8-None-1
	Flow control	None
Input Setup:	Station	Any
NMEA/ASCII (all supported messages)		All ports Off
Streamed output		All types Off Offset = 00
RT17/Binary		All ports Off
Reference position:	Latitude	0°
	Longitude	0°
	Altitude	0.00 m HAE (Height above ellipsoid)
Antenna:	Type	Zephyr Geodetic Model 2
	Height (true vertical)	0.00 m
	Measurement method	Bottom of antenna mount

Resetting the receiver to factory defaults

To reset the receiver to its factory defaults, press  for 35 seconds.

Data Logging option

By default, the Data Logging option is turned off in SPS GPS receivers. If you choose to log data using a GPS receiver, you must enable the option and acquire suitable GPS postprocessing software, such as the Trimble Geomatics Office software. For more information, please contact your Trimble dealer.

Postprocessed GPS data is typically used for control network measurement applications and precise monitoring. GPS measurement data is collected over a period of time at a static point or points and then postprocessed to accurately compute baseline information.

Logging data after a power loss

If power is unexpectedly lost while the receiver is logging data, once power is restored, the receiver tries to return to the state it was in immediately before the power loss. The receiver does not reset itself to default settings.

If the receiver was logging data when power was lost, data logging is resumed when power is provided.

Specifications

In this chapter:

- General specifications
- Physical specifications
- Performance specifications
- Electrical specifications
- Communication specifications
- GPS satellite signal tracking
- Integrated radio options
- Variable configuration options

This chapter details the specifications for the receiver.

Specifications are subject to change without notice.

General specifications

Feature	Specification
Keyboard and display	VFD display 16 characters by 2 rows On/Off key for one button startup using AutoBase technology Escape and Enter key for menu navigation 4 arrow keys (up, down, left, right) for option scrolls and data entry
Receiver type	Modular GPS receiver
Antenna type	
L1/L2/L2C GPS operations	Zephyr Model 2, GA510
GLONASS operations	Zephyr Model 2
Base station	Zephyr Geodetic Model 2
OmniSTAR operations	GA510, Zephyr Model 2 Also supports legacy Trimble antennas Z+ Choke ring, Zephyr, Zephyr Geodetic, Micro-Centered™.

Physical specifications

Feature	Specification
Dimensions (L x W x H)	24 cm (9.4 in) x 12 cm (4.7 in) x 5 cm (1.9 in) including connectors
Weight	1.65 kg (3.64 lbs) receiver with internal battery and radio 1.55 kg (3.42 lbs) receiver with internal battery and no radio
Temperature ¹	
Operating	-40 °C to +65 °C (-40 °F to +149 °F)
Storage	-40 °C to +80 °C (-40 °F to +176 °F)
Humidity	MIL-STD 810F, Method 507.4
Waterproof	IP67 for submersion to depth of 1 m (3.30 ft)
Shock and vibration	Tested and meets the following environmental standards:
Shock, non operating	Designed to survive a 1 m (3.3 ft) pole drop onto a hard surface to 75 g, 6 ms
Shock, operating	To 40 g, 10 ms, saw-tooth
Vibration	Tested to Trimble ATV profile (4.5 g _{RMS}): 10 Hz – 300 Hz: 0.04 g ² /Hz 300 Hz – 1,000 Hz; -6 dB/octave

¹ Receiver will operate normally to -40 °C. Internal batteries are rated to -20 °C.

Performance specifications

Feature	Specification
Measurements	<ul style="list-style-type: none"> Advanced Trimble Maxwell™ 5 Custom GPS chip High-precision multiple correlator for L1/L2 pseudo-range measurements Unfiltered, unsmoothed pseudo-range measurements for low-noise, low multipath error, low-time domain correclation, and high-dynamic response Very low noise carrier phase measurements with <1 mm precision in a 1 Hz bandwidth L1/L2 signal-to-noise ratios reported in dB-Hz Proven Trimble low-elevation tracking technology Trimble EVEREST™ multipath signal rejection 72-channel L1 C/A Code, L1/L2 Full Cycle Carrier. Upgradable to L2C and GLONASS L1/L2 Full Cycle Carrier. See page 114. 72-channel L1 C/A Code, L1/L2/L2C Full Cycle Carrier (SPS751/SPS851). Upgradable to GLONASS L1/L2 Full Cycle Carrier and L5. See page 114. (SPS851) 4-channel SBAS (WAAS, EGNOS, and MSAS corrections)
Code differential GPS positioning ¹	
Horizontal accuracy	±(0.25 m + 1 ppm) RMS, ± (0.8 ft + 1 ppm) RMS
Vertical accuracy	±(0.50 m + 1 ppm) RMS, ± (1.6 ft + 1 ppm) RMS
SBAS (WAAS/EGNOS/MSAS)	
Horizontal accuracy ²	Typically <1 m (3.3 ft)
Vertical accuracy ²	Typically <5 m (16.4 ft)
OmniSTAR positioning	
VBS service accuracy	Horizontal <1 m (3.3 ft)
XP service accuracy	Horizontal 0.2 m (0.66 ft), Vertical 0.3 m (1.0 ft)
HP service accuracy	Horizontal 0.1 m (0.33 ft), Vertical 0.15 m (0.5 ft)
Location RTK positioning	
Horizontal accuracy	±(0.07 m + 1 ppm) RMS, ± (0.23 ft +1 ppm) RMS
Vertical accuracy	±(0.07 m + 1 ppm) RMS, ± (0.23 ft +1 ppm) RMS (SPS551) ±(0.02 m + 1 ppm) RMS, ± (0.07 ft +1 ppm) RMS (SPS651)
RTK positioning	
Horizontal accuracy	±(10 mm + 1 ppm) RMS, ± (0.032 ft +1 ppm) RMS (SPS751/SPS851)
Vertical accuracy	±(20 mm + 1 ppm) RMS, ± (0.065 ft +1 ppm) RMS (SPS751/SPS851)
Heading accuracy with additional SPS551, SPS551H, SPS751, or SPS851	0.05° RMS (10 m antenna separation) Does not require shore-based corrections for heading solution
Initialization time	
Regular RTK operation with base station	Single/Multi-base minimum 10 sec + 0.5 times baseline length in km, <30 km
RTK operation with Scalable GPS infrastructure	Typically, <30 seconds anywhere within coverage area (SPS751 Max and SPS851 only).
Initialization reliability ³	Typically >99.9%

¹ Accuracy and reliability may be subject to anomalies such as multipath, obstructions, satellite geometry, and atmospheric conditions. Always follow recommended practices.

² Depends on WAAS, EGNOS, and MSAS system performance.

³ May be affected by atmospheric conditions, signal multipath, and satellite geometry. Initialization reliability is continuously monitored to ensure highest quality.

Electrical specifications

Feature	Specification
Power	
Internal	<p>Integrated internal battery 7.4 V, 7800 mA-hr, Lithium-ion</p> <p>Internal battery operates as a UPS in the event of external power source failure</p> <p>Internal battery will charge from external power source when input voltage is >15 V</p> <p>Integrated charging circuitry</p>
External	<p>Power input on Lemo 7-pin 0-shell is optimized for lead acid batteries with a cut-off threshold of 10.5 V</p> <p>Power input on the 26-pin D-sub connector is optimized for Trimble Lithium-ion battery input (P/N 49400) with a cut-off threshold of 9.5 V</p> <p>Power source supply (Internal/External) is hot-swap capable in the event of power source removal or cut off</p> <p>9.5 V to 28 V DC external power input with over-voltage protection</p> <p>Receiver will automatically turn on when connected to external power</p>
Power consumption	<p>6 W, in rover mode with internal receive radio</p> <p>8 W in base mode with internal transmit radio</p>
Base station operation times on internal battery	
External radio	14 hours; varies with temperature
450 MHz 0.5 W systems ¹	10 hours; varies with temperature
900 MHz 1.0 W systems	9 hours; varies with temperature
Rover operation time on internal battery	
450 MHz 2.0 W systems	12 hours; varies with temperature
900 MHz 1.0 W systems	12 hours; varies with temperature
Regulatory approvals	<p>FCC: Part 15 Subpart B (Class B Device) and Subpart C, Part 90</p> <p>Industry Canada: ICES-003 (Class B Device), RSS-210, RSS-Gen, RSS-310, RSS-119</p> <p>R&TTE Directive: EN 301 489-1/-5/-17, EN 300 440, EN 300 328, EN 300 113, EN 60950, EN 50371</p> <p>ACMA: AS/NZS 4295 approval</p> <p>CE mark compliance</p> <p>C-tick mark compliance</p> <p>UN ST/SG/AC.10.11/Rev. 3, Amend. 1 (Li-Ion Battery)</p> <p>UN ST/SG/AC. 10/27/Add. 2 (Li-Ion Battery)</p> <p>RoHS compliant (excludes receivers with an internal 900 MHz radio)</p> <p>WEEE compliant</p>

¹If your receiver has the 2.0 W upgrade, you will experience lesser battery performance compared to the 0.5 W solution.

Communication specifications

Feature	Specification
Communications	
Port 1 (7-pin 05 Lemo)	3-wire RS-232/CAN
Port 2 (26-pin D-sub)	Full RS-232 (through multi-port adaptor) 3-wire RS-232
1PPS (1 Pulse per second)	Through adaptor cable
USB (On the Go)	Through mutli-port adaptor
Ethernet	Through mutli-port adaptor
Bluetooth	Fully-integrated, fully-sealed 2.4 GHz Bluetooth ¹ module
Integrated radios (optional)	Fully-integrated, fully-sealed internal 450 MHz (UHF), Tx, Rx, or Tx/Rx Fully-integrated, fully-sealed internal 900 MHz, Tx, Rx, or Tx/Rx
Channel spacing (450 MHz)	12.5 KHz or 25 KHz spacing available
450 MHz transmitter radio power output	0.5 W / 2.0 W (2.0 W upgrade available only in certain countries)
Frequency approvals (900 MHz)	USA/CAN (-10), New Zealand/Australia (-20), Australia (-30)
900 MHz transmitter radio power output	1.0 W (30 dBm)
External GSM/GPRS, cellular phone support	Supported for direct dial and Internet-based VRS correction streams Cellular phone or GSM/GPRS modem inside a TSC2 controller
Receiver position update rate	1 Hz, 2 Hz, 5 Hz, 10 Hz, and 20 Hz positioning (varies by receiver model)
Correction data input	CMR, CMR+, RTCM 2.0 (select RTCM 2.1), RTCM 2.1–2.3, RTCM 3.
Correction data output	CMR, CMR+, RTCM 2.0 (select RTCM 2.1), RTCM 2.1–2.3.
Data outputs	NMEA, GSOE, 1PPS Time Tags

¹ Bluetooth type approvals are country specific. For more information, contact your local Trimble office or representative.

GPS satellite signal tracking

This table shows the GPS satellite signal tracking capability for each receiver in the SPSx51 Modular GPS receiver family.

GPS signal type	Class	SPS551	SPS551H	SPS651	SPS751 Basic base	SPS751 Basic rover	SPS751 Max	SPS851
GPS signals	L1/L2	✓	✓	✓	✓	✓	✓	✓
	L2C	Optional	Optional	Optional	✓	✓	✓	✓
	L5	✗	✗	✗	✗	✗	✗	Optional
GLONASS signals	L1/L2	Optional	Optional	Optional	✗	✗	✗	Optional
GPS SBAS corrections	WAAS	✓	✓	✓	✓	✓	✓	✓
	EGNOS	✓	✓	✓	✓	✓	✓	✓
	MSAS	✓	✓	✓	✓	✓	✓	✓
OmniSTAR corrections	XP	✓	✗	✓	✓	✓	✓	✓
	HP	✓	✗	✓	✓	✓	✓	✓
	VBS	✓	✗	✓	✓	✓	✓	✓

Integrated radio options

Except for the SPS551H, all the receiver configurations are available with or without internal radios with 450 MHz or 900 MHz frequency ranges. The SPS551H is not available with a radio.

This table shows the radio options available for each receiver in the SPSx51 Modular GPS receiver family.

Radio option	SPS551	SPS551H	SPS651	SPS751 Basic base	SPS751 Basic rover	SPS751 Max	SPS851
No radio	✓	✓	✓	✓	✓	✓	✓
450 MHz Transmit	✓	✗	✓	✓	✗	✓	✓
450 MHz Receive	✓	✗	✓	✗	✓	✓	✓
900 MHz Transmit	✓	✗		✓	✗	✓	✓
900 MHz Receive	✓	✗	✓	✗	✓	✓	✓
External 450 MHz Transmit	Optional	✗	Optional	Optional	Optional	Optional	Optional
External 900 MHz Transmit	Optional	✗	Optional	Optional	Optional	Optional	Optional

Variable configuration options

This table lists the default options for each receiver in the SPSx51 Modular GPS receiver family.

Configuration option	SPS551	SPS551H	SPS651	SPS751 Basic base	SPS751 Basic rover	SPS751 Max	SPS851
Rover options							
Precise horizontal	–	–	–	–	✓	✓	✓
Precise vertical	–	–	✓	–	✓	✓	✓
Precise heading/vector	✓	✓	✓	–	–	✓	✓
Location RTK	✓	–	✓	–	–	–	–
RTCM DGPS	✓	–	✓	–	✓	✓	✓
RTK range limit	–	2.4 km	–	–	2.4 km	None	None
Base options							
Static RTK	–	–	–	✓	–	✓	✓
Moving Base	✓	✓	✓	–	–	✓	✓
RTCM DGPS	✓	–	✓	✓	–	✓	✓
General options							
Data logging	–	–	–	–	–	Optional	Optional
VRS support	Location	–	Location	–	–	✓	✓
Max data rate	10 Hz	10 Hz	10 Hz	2 Hz	2 Hz	10 Hz	20 Hz

Upgrading the receiver

You can upgrade the following receivers:

- SPS751 Basic base or SPS751 Basic rover to the SPS751 Max.
The upgrade changes all standard options to SPS751 Max capability, and includes the radio option upgrade.
- The SPS551, SPS551H, and SPS651 can be upgraded with GLONASS and/or L2C.
- The SPS851 can be upgraded with GLONASS and/or L5.
- The SPSx51 with 450 MH UHF internal radios can be upgraded to 2 W transmission power if it is legally allowed in its country of use.
- The SPS751 Max and SPS851 can be upgraded to allow internal data logging.

When you purchase the receiver upgrade, your Trimble dealer will provide you with a set of codes to change the receiver configuration. See also [Appendix F, Upgrading the Receiver Firmware](#).

NMEA-0183 Output

In this appendix:

- [NMEA-0183 message overview](#)
- [Common message elements](#)
- [NMEA messages](#)

This appendix describes the formats of the subset of NMEA-0183 messages that are available for output by the receivers. For a copy of the NMEA-0183 Standard, go to the National Marine Electronics Association website at www.nmea.org.

NMEA-0183 message overview

When NMEA-0183 output is enabled, a subset of NMEA-0183 messages can be output to external instruments and equipment connected to the receiver serial ports. These NMEA-0183 messages let external devices use selected data collected or computed by the GPS receiver.

All messages conform to the NMEA-0183 version 3.01 format. All begin with \$ and end with a carriage return and a line feed. Data fields follow comma (,) delimiters and are variable in length. Null fields still follow comma (,) delimiters but contain no information.

An asterisk (*) delimiter and checksum value follow the last field of data contained in an NMEA-0183 message. The checksum is the 8-bit exclusive of all characters in the message, including the commas between fields, but not including the \$ and asterisk delimiters. The hexadecimal result is converted to two ASCII characters (0–9, A–F). The most significant character appears first.

The following table summarizes the set of NMEA messages supported by the receiver, and shows the page that contains detailed information about each message.

Message	Function	Page
GGA	Time, position, and fix related data	120
GSA	GPS DOP and active satellites	121
GST	Position error statistics	122
GSV	Number of SVs in view, PRN, elevation, azimuth, and SNR	123
HDT	Heading from True North	124
PTNL,AVR	Time, yaw, tilt, range, mode, PDOP, and number of SVs for Moving Baseline RTK	125
PTNL, BPQ	Base station position and position quality indicator	126
PTNL,GGK	Time, position, position type and DOP values	127
PTNL,PJK	Local coordinate position output	128
PTNL,VGK	Time, locator vector, type and DOP values	129
PTNL,VHD	Heading Information	130
RMC	Position, Velocity, and Time	131
ROT	Rate of turn	132
VTG	Actual track made good and speed over ground	133
ZDA	UTC day, month, and year, and local time zone offset	134

To enable or disable the output of individual NMEA messages, do one of the following:

- Create an application file in the GPS Configurator software that contains NMEA output settings and then send the file to the receiver.
- Add NMEA outputs in the *Serial outputs* tab of the GPS Configurator software and then apply the settings. (You cannot use the GPS Configuration software to load application files to the SPSx51 Modular GPS receivers.)
- For SPSx51 Modular GPS receivers, set up the NMEA output using the keypad and display or a web browser.

Common message elements

Each message contains:

- a message ID consisting of *\$GP* followed by the message type. For example, the message ID of the GGA message is *\$GPGGA*.
- a comma
- a number of fields, depending on the message type, separated by commas
- an asterisk
- a checksum value

Below is an example of a simple message with a message ID (*\$GPGGA*), followed by 13 fields and a checksum value:

```
$GPGGA,172814.0,3723.46587704,N,12202.26957864,W,2,6,1.2,18.893,M,-
25.669,M,2.0,0031*4F
```

Message values

NMEA messages that the receiver generates contains the following values.

Latitude and longitude

Latitude is represented as *ddmm.mmmm* and longitude is represented as *dddmm.mmmm*, where:

- *dd* or *ddd* is degrees
- *mm.mmmm* is minutes and decimal fractions of minutes

Direction

Direction (north, south, east, or west) is represented by a single character: *N*, *S*, *E*, or *W*.

Time

Time values are presented in Universal Time Coordinated (UTC) and are represented as *hhmmss.cc*, where:

- *hh* is hours, from 00 through 23
- *mm* is minutes
- *ss* is seconds
- *cc* is hundredths of seconds

NMEA messages

When NMEA-0183 output is enabled, the following messages can be generated.

GGA Time, Position, and Fix Related Data

An example of the GGA message string is shown below. [Table A.1](#) describes the message fields.

Note – The following data string exceeds the NMEA standard length.

```
$GPGGA,172814.0,3723.46587704,N,12202.26957864,W,
2,6,1.2,18.893,M,-25.669,M,2.0,0031*4F
```

Table A.1 GGA message fields

Field	Meaning
0	Message ID \$GPGGA
1	UTC of position fix
2	Latitude
3	Direction of latitude: N: North S: South
4	Longitude
5	Direction of longitude: E: East W: West
6	GPS Quality indicator: 0: Fix not valid 1: GPS fix 2: Differential GPS fix, OmniSTAR VBS 4: Real-Time Kinematic, fixed integers 5: Real-Time Kinematic, float integers, OmniSTAR XP/HP or Location RTK
7	Number of SVs in use, range from 00 through 12
8	HDOP
9	Orthometric height (MSL reference)
10	M: unit of measure for orthometric height is meters
11	Geoid separation
12	M: geoid separation is measured in meters
13	Age of differential GPS data record, Type 1 or Type 9. Null field when DGPS is not used.
14	Reference station ID, ranging from 0000 through 1023. A null field when any reference station ID is selected and no corrections are received ¹ .
15	The checksum data, always begins with *

¹When using OmniSTAR services, ID=100 for OmniSTAR VBS, ID=1000 for OmniSTAR HP, and ID=1008 for OmniSTAR XP.

GSA **GPS DOP and active satellites**

An example of the GSA message string is shown below. [Table A.2](#) describes the message fields.

```
$GPGSA,<1>,<2>,<3>,<3>,,,,,<3>,<3>,<3>,<4>,<5>,<6>*<7><CR><LF>
```

Table A.2 GSA message fields

Field	Meaning
0	Message ID \$GPGSA
1	Mode 1, M = manual, A = automatic
2	Mode 2, Fix type, 1 = not available, 2 = 2D, 3 = 3D
3	PRN number, 01 through 32, of satellite used in solution, up to 12 transmitted
4	PDOP-Position dilution of precision, 0.5 through 99.9
5	HDOP-Horizontal dilution of precision, 0.5 through 99.9
6	VDOP-Vertical dilution of precision, 0.5 through 99.9
7	The checksum data, always begins with *

GST Position Error Statistics

An example of the GST message string is shown below. [Table A.3](#) describes the message fields.

```
$GPGST,172814.0,0.006,0.023,0.020,273.6,0.023,0.020,0.031*6A
```

Table A.3 GST message fields

Field	Meaning
0	Message ID \$GPGST
1	UTC of position fix
2	RMS value of the pseudorange residuals; includes carrier phase residuals during periods of RTK(float) and RTK(fixed) processing
3	Error ellipse semi-major axis 1 sigma error, in meters
4	Error ellipse semi-minor axis 1 sigma error, in meters
5	Error ellipse orientation, degrees from true north
6	Latitude 1 sigma error, in meters
7	Longitude 1 sigma error, in meters
8	Height 1 sigma error, in meters
9	The checksum data, always begins with *

GSV **Satellite Information**

The GSV message string identifies the number of SVs in view, the PRN numbers, elevations, azimuths, and SNR values. An example of the GSV message string is shown below. [Table A.4](#) describes the message fields.

```
$GPGSV,4,1,13,02,02,213,,03,-3,000,,11,00,121,,14,13,172,05*67
```

Table A.4 GSV message fields

Field	Meaning
0	Message ID \$GPGSV
1	Total number of messages of this type in this cycle
2	Message number
3	Total number of SVs visible
4	SV PRN number
5	Elevation, in degrees, 90° maximum
6	Azimuth, degrees from True North, 000° through 359°
7	SNR, 00–99 dB (null when not tracking)
8–11	Information about second SV, same format as fields 4 through 7
12–15	Information about third SV, same format as fields 4 through 7
16–19	Information about fourth SV, same format as fields 4 through 7
20	The checksum data, always begins with *

HDT Heading from True North

The HDT string is shown below, and [Table A.5](#) describes the message fields.

```
$GPHDT,123.456,T*00
```

Table A.5 Heading from true north fields

Field	Meaning
0	Message ID \$GPHDT
1	Heading in degrees
2	T: Indicates heading relative to True North
3	The checksum data, always begins with *

PTNL,AVR**Time, Yaw, Tilt, Range for Moving Baseline RTK**

The PTNL,AVR message string is shown below, and [Table A.6](#) describes the message fields.

```
$PTNL,AVR,181059.6,+149.4688,Yaw,+0.0134,Tilt,,,60.191,3,2.5,6*00
```

Table A.6 AVR message fields

Field	Meaning
0	Message ID \$PTNL,AVR
1	UTC of vector fix
2	Yaw angle in degrees
3	Yaw
4	Tilt angle in degrees
5	Tilt
6	Reserved
7	Reserved
8	Range in meters
9	GPS quality indicator: 0: Fix not available or invalid 1: Autonomous GPS fix 2: Differential carrier phase solution RTK (Float) 3: Differential carrier phase solution RTK (Fix) 4: Differential code-based solution, DGPS
10	PDOP
11	Number of satellites used in solution
12	The checksum data, always begins with *

PTNL,BPQ**Base station position and quality indicator**

This message describes the base station position and its quality. It is used when the moving base antenna position and quality are required on one serial port (along with a heading message) from a receiver in heading mode, typically the SPS551H.

The PTNL,BPQ message string is shown below, and [Table A.7](#) describes the message fields.

```
$PTNL,BPQ,224445.06,021207,3723.09383914,N,12200.32620132,W,EHT-5.923,
M,5*
```

Table A.7 BPQ message fields

Field	Meaning
0	Talker ID
1	BPQ
2	UTC time of position fix, in hhmmss.ss format. Hours must be two numbers, so may be padded, for example, 7 is shown as 07.
3	UTC date of position fix, in ddmmyy format. Day must be two numbers, so may be padded, for example, 8 is shown as 08.
4	Latitude, in degrees and decimal minutes (ddmm.mmmmmmm)
5	Direction of latitude: N: North S: South
6	Longitude, in degrees and decimal minutes (dddmm.mmmmmmm). Should contain 3 digits of ddd.
7	Direction of longitude: E: East W: West
8	Height Ellipsoidal height of fix (antenna height above ellipsoid). Must start with EHT.
9	M: ellipsoidal height is measured in meters
10	GPS quality indicator: 0: Fix not available or invalid 1: Autonomous GPS fix 2: Differential SBAS, or OmniSTAR VBS 4: RTK Fixed 5: OmniSTAR XP, OmniSTAR HP, Float RTK, or Location RTK
11	The checksum data, always begins with *

PTNL,GGK**Time, Position, Position Type, DOP**

An example of the PTNL,GGK message string is shown below. [Table A.8](#) describes the message fields.

```
$PTNL,GGK,453049.0,0,3728.455440850,N,12215.253291068,W,3,9,2.0,EHT35.742
4,M*
```

Table A.8 PTNL,GGK message fields

Field	Meaning
0	Talker ID \$PTNL
1	Message ID GGK
2	UTC time of position fix, in hhmmss.ss format. Hours must be two numbers, so may be padded, for example, 7 is shown as 07.
3	UTC date of position fix, in ddmmyy format. Day must be two numbers, so may be padded, for example, 8 is shown as 08.
4	Latitude, in degrees and decimal minutes (dddmm.mmmmmmm)
5	Direction of latitude: N: North S: South
6	Longitude, in degrees and decimal minutes (dddmm.mmmmmmm). Should contain three digits of ddd.
7	Direction of longitude: E: East W: West
8	GPS Quality indicator: 0: Fix not available or invalid 1: Autonomous GPS fix 2: RTK float solution 3: RTK fix solution 4: Differential, code phase only solution (DGPS) 5: SBAS solution – WAAS, EGNOS, MSAS 6: RTK float or RTK location 3D Network solution 7: RTK fixed 3D Network solution 8: RTK float or RTK location 2D in a Network solution 9: RTK fixed 2D Network solution 10: OmniSTAR HP/XP solution 11: OmniSTAR VBS solution 12: Location RTK solution
9	Number of satellites in fix
10	Ellipsoidal height of fix (antenna height above ellipsoid). Must start with EHT.
11	M: ellipsoidal height is measured in meters
12	The checksum data, always begins with *

Note – The PTNL,GGK message is longer than the NMEA-0183 standard of 80 characters.

PTNL,PJK**Local Coordinate Position Output**

An example of the PTNL,PJK message string is shown below. [Table A.9](#) describes the message fields.

```
$PTNL,PJK,010717.00,081796,+732646.511,N,+1731051.091,E,1,05,2.7,EHT-
28.345,M*7C
```

Table A.9 PTNL,PJK message fields

Field	Meaning
0	Message ID \$PTNL,PJK
1	UTC of position fix
2	Date
3	Northing, in meters
4	Direction of Northing will always be N (North)
5	Easting, in meters
6	Direction of Easting will always be E (East)
7	GPS Quality indicator: 0: Fix not available or invalid 1: Autonomous GPS fix 2: RTK float solution 3: RTK fix solution 4: Differential, code phase only solution (DGPS) 5: SBAS solution – WAAS, EGNOS, MSAS 6: RTK Float 3D network solution 7: RTK Fixed 3D network solution 8: RTK Float 2D network solution 9: RTK Fixed 2D network solution 10: OmniSTAR HP/XP solution 11: OmniSTAR VBS solution
8	Number of satellites in fix
9	DOP of fix
10	Ellipsoidal height of fix
11	M: ellipsoidal height is measured in meters
12	The checksum data, always begins with *

Note – The PTNL,PJK message is longer than the NMEA-0183 standard of 80 characters.

PTNL,VGK**Vector Information**

An example of the PTNL,VGK message string is shown below. [Table A.10](#) describes the message fields.

```
$PTNL,VGK,160159.00,010997,-0000.161,00009.985,-0000.002,3,07,1,4,M*0B
```

Table A.10 PTNL,VGK message fields

Field	Meaning
0	Message ID \$PTNL,VGK
1	UTC of vector in hhmmss.ss format
2	Date in mmddy format
3	East component of vector, in meters
4	North component of vector, in meters
5	Up component of vector, in meters
6	GPS Quality indicator: 0: Fix not available or invalid 1: Autonomous GPS fix 2: RTK float solution 3: RTK fix solution 4: Differential, code phase only solution (DGPS) 5: SBAS solution – WAAS, EGNOS, MSAS 6: RTK Float 3D network solution 7: RTK Fixed 3D network solution 8: RTK Float 2D network solution 9: RTK Fixed 2D network solution 10: OmniSTAR HP/XP solution 11: OmniSTAR VBS solution
7	Number of satellites if fix solution
8	DOP of fix
9	M: Vector components are in meters
10	The checksum data, always begins with *

PTNL,VHD**Heading Information**

An example of the PTNL,VHD message string is shown below. [Table A.11](#) describes the message fields.

```
$PTNL,VHD,030556.00,093098,187.718,-22.138,-76.929,-
5.015,0.033,0.006,3,07,2.4,M*22
```

Table A.11 PTNL,VHD message fields

Field	Meaning
0	Message ID \$PTNL,VHD
1	UTC of position in hhmmss.ss format
2	Date in mmddyy format
3	Azimuth
4	Δ Azimuth/ Δ Time
5	Vertical Angle
6	Δ Vertical/ Δ Time
7	Range
8	Δ Range/ Δ Time
9	GPS Quality indicator: 0: Fix not available or invalid 1: Autonomous GPS fix 2: RTK float solution 3: RTK fix solution 4: Differential, code phase only solution (DGPS) 5: SBAS solution – WAAS, EGNOS, MSAS 6: RTK Float 3D network solution 7: RTK Fixed 3D network solution 8: RTK Float 2D network solution 9: RTK Fixed 2D network solution 10: OmniSTAR HP/XP solution 11: OmniSTAR VBS solution
10	Number of satellites used in solution
11	PDOP
12	The checksum data, always begins with *

RMC **Position, Velocity, and Time**

The RMC string is shown below, and [Table A.12](#) describes the message fields.

```
$GPRMC,123519,A,4807.038,N,01131.000,E,022.4,084.4,230394,003.1,W*6A
```

Table A.12 GPRMC message fields

Field	Meaning
0	Message ID \$GPRMC
1	UTC of position fix
2	Status A=active or V=void
3	Latitude
4	Longitude
5	Speed over the ground in knots
6	Track angle in degrees (True)
7	Date
8	Magnetic variation in degrees
9	The checksum data, always begins with *

ROT **Rate and Direction of Turn**

The ROT string is shown below, and [Table A.13](#) describes the message fields.

```
$GPROT,35.6,A*4E
```

Table A.13 ROT message fields

Field	Meaning
0	Message ID \$GPROT
1	Rate of turn, degrees/minutes, "-" indicates bow turns to port
2	A: Valid data V: Invalid data
3	The checksum data, always begins with *

VTG Track Made Good and Speed Over Ground

An example of the VTG message string is shown below, and [Table A.14](#) describes the message fields.

```
$GPVTG,,T,,M,0.00,N,0.00,K*4E
```

Table A.14 VTG message fields

Field	Meaning
0	Message ID \$GPVTG
1	Track made good (degrees true)
2	T: track made good is relative to true north
3	Track made good (degrees magnetic)
4	M: track made good is relative to magnetic north
5	Speed, in knots
6	N: speed is measured in knots
7	Speed over ground in kilometers/hour (kph)
8	K: speed over ground is measured in kph
9	The checksum data, always begins with *

ZDA UTC Day, Month, And Year, and Local Time Zone Offset

An example of the ZDA message string is shown below, and [Table A.15](#) describes the message fields.

```
$GPZDA,172809,12,07,1996,00,00*45
```

Table A.15 ZDA message fields

Field	Meaning
0	Message ID \$GPZDA
1	UTC
2	Day, ranging between 01 and 31
3	Month, ranging between 01 and 12
4	Year
5	Local time zone offset from GMT, ranging from 00 through ± 13 hours
6	Local time zone offset from GMT, ranging from 00 through 59 minutes
7	The checksum data, always begins with *

Fields 5 and 6 together yield the total offset. For example, if field 5 is -5 and field 6 is $+15$, local time is 5 hours and 15 minutes earlier than GMT.

GSOF Messages

In this appendix:

- [Supported message types](#)
- [General Serial Output Format](#)
- [Reading binary values](#)
- [GSOF message definitions](#)

This appendix provides information on the General Serial Output Format (GSOF) messages. GSOF messages are a Trimble proprietary format and can be used to send information such as position and status to a third-party device.

For information on how to output GSOF messages, see [Chapter 6, Configuring the Receiver Using the Keypad and Display](#) and [Chapter 7, Configuring the Receiver Settings](#).

Supported message types

This table summarizes the GSOF messages that are supported by the receiver, and shows the page that contains detailed information about each message.

Message	Description	Page
TIME	Position time	140
LLH	Latitude, longitude, height	140
ECEF	Earth-Centered, Earth-Fixed position	141
ECEF DELTA	Earth-Centered, Earth-Fixed Delta position	141
NEU DELTA	Tangent Plane Delta	141
Velocity	Velocity data	142
PDOP	PDOP info	143
SIGMA	Position Sigma info	143
SV Brief	SV Brief info	144
SV Detail	SV Detailed info	144
UTC	Current UTC time	145
BATT/MEM	Receiver battery and memory status	146
ATTITUDE	Attitude info	146
BASE POSITION AND QUALITY INDICATOR	Base station position and its quality	147

General Serial Output Format

Table B.1 Report packet 40h structure (GENOUT)

Byte	Item	Type	Value	Meaning
0	STX	CHAR	02h	Start transmission.
1	STATUS	CHAR	See Table B.2	Receiver status code.
2	PACKET TYPE	CHAR	40h	Report Packet 40h (GENOUT).
3	LENGTH	CHAR	00h–FAh	Data byte count.
4	TRANSMISSION NUMBER	CHAR		Unique number assigned to a group of record packet pages. Prevents page mismatches when multiple sets of record packets exist in output stream.
5	PAGE INDEX	CHAR	00h–FFh	Index of current packet page.
6	MAX PAGE INDEX	CHAR	00h–FFh	Maximum index of last packet in one group of records.
<i>One or more GSOF messages</i>				
	Output record type	CHAR	01h	For example, Time (Type 1 Record).
	Record length	CHAR	0Ah	Bytes in record.
<i>Various fields depending on Output record type</i>				
There can be multiple records in one GENOUT packet. There could be multiple GENOUT packets per epoch. Records may be split over two consecutive packets.				

Table B.1 Report packet 40h structure (GENOUT)

Byte	Item	Type	Value	Meaning
Length + 4	CHECKSUM	–	–	(Status + type + length + data bytes) modulo 256
Length + 5	ETX (03h)	–	–	End transmission

Each message begins with a 4-byte header, followed by the bytes of data in each packet. The packet ends with a 2-byte trailer. Byte 3 is set to 0 (00h) when the packet contains no data. Most data is transmitted between the receiver and remote device in binary format.

Table B.2 Receiver Status code

Byte number	Message	Description
Bit 0	1	Reserved
Bit 1	1	Low battery
Bit 2–7	0–63	Reserved

Reading binary values

The receivers store numbers in Motorola format. The byte order of these numbers is the opposite of what personal computers (PCs) expect (Intel format). To supply or interpret binary numbers (8-byte DOUBLES, 4-byte LONGS, and 2-byte INTEGERS), the byte order of these values must be reversed. This section contains a detailed description of the Motorola format.

INTEGER data types

The INTEGER data types (CHAR, SHORT, and LONG) can be signed or unsigned. By default, they are unsigned. All integer data types use two's complement representation. The following table lists the integer data types.

Type	# of bits	Range of values (Signed)	(Unsigned)
CHAR	8	–128 to 127	0 to 255
SHORT	16	–32768 to 32767	0 to 65535
LONG	32	–2147483648 to 2147483647	0 to 4294967295

FLOATING-POINT data types

Floating-point data types are stored in the IEEE SINGLE and DOUBLE precision formats. Both formats have a sign bit field, an exponent field, and a fraction field. The fields represent floating-point numbers in the following manner:

$$\text{Floating-Point Number} = \langle \text{sign} \rangle 1. \langle \text{fraction field} \rangle \times 2^{(\langle \text{exponent field} \rangle - \text{bias})}$$

- **Sign bit field**

The sign bit field is the most significant bit of the floating-point number. The sign bit is 0 for positive numbers and 1 for negative numbers.

- **Fraction field**

The fraction field contains the fractional part of a normalized number. Normalized numbers are greater than or equal to 1 and less than 2. Since all normalized numbers are of the form 1.XXXXXXXXX, the 1 becomes implicit and is not stored in memory. The bits in the fraction field are the bits to the right of the binary point, and they represent negative powers of 2.

For example:

$$0.011 \text{ (binary)} = 2^{-2} + 2^{-3} = 0.25 + 0.125 = 0.375$$

- **Exponent field**

The exponent field contains a biased exponent; that is, a constant bias is subtracted from the number in the exponent field to yield the actual exponent. (The bias makes negative exponents possible.)

If both the exponent field and the fraction field are zero, the floating-point number is zero.

- **NaN**

A NaN (Not a Number) is a special value which is used when the result of an operation is undefined. For example, adding positive infinity to negative infinity results in a NaN.

FLOAT data type

The FLOAT data type is stored in the IEEE single-precision format which is 32 bits long. The most significant bit is the sign bit, the next 8 most significant bits are the exponent field, and the remaining 23 bits are the fraction field. The bias of the exponent is 127. The range of single-precision format values is from 1.18×10^{-38} to 3.4×10^{38} . The floating-point number is precise to 6 decimal digits.

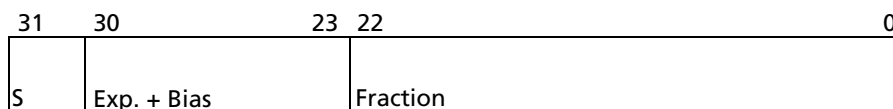

$$0\ 000\ 0000\ 0\ 000\ 0000\ 0000\ 0000\ 0000\ 0000 = 0.0$$

$$0\ 011\ 1111\ 1\ 000\ 0000\ 0000\ 0000\ 0000\ 0000 = 1.0$$

$$1\ 011\ 1111\ 1\ 011\ 0000\ 0000\ 0000\ 0000\ 0000 = -1.375$$

$$1\ 111\ 1111\ 1\ 111\ 1111\ 1111\ 1111\ 1111\ 1111 = \text{NaN}$$

DOUBLE

The DOUBLE data type is stored in the IEEE double-precision format which is 64 bits long. The most significant bit is the sign bit, the next 11 most significant bits are the exponent field, and the remaining 52 bits are the fractional field. The bias of the exponent is 1023. The range of single precision format values is from 2.23×10^{-308} to 1.8×10^{308} . The floating-point number is precise to 15 decimal digits.

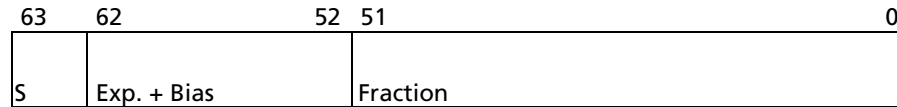

0 000 0000 0000 0000 0000 ... 0000 0000 0000 = 0.0

0 011 1111 1111 0000 0000 ... 0000 0000 0000 = 1.0

1 011 1111 1110 0110 0000 ... 0000 0000 0000 = -0.6875

1 111 1111 1111 1111 1111 ... 1111 1111 1111 = NaN

GSOE message definitions

When GSOE output is enabled, the following messages can be generated.

TIME

This message describes position time information. It contains the following data:

- GPS time, in milliseconds of GPS week
- GPS week number
- Number of satellites used
- Initialization counter

Table B.3 Time (Type 1 record)

Field	Item	Type	Value	Meaning
0	Output record type	Char	01h	Position time output record
1	Record length	Char	0Ah	Bytes in record
2–5	GPS time (ms)	Long	msecs	GPS time, in milliseconds of GPS week
6–7	GPS week number	Short	number	GPS week count since January 1980
8	Number of SVs used	Char	00h-0Ch	Number of satellites used to determine the position (0-12)
9	Position flags 1	Char	See Table B.17	Reports first set of position attribute flag values
10	Position flags 2	Char	See Table B.18	Reports second set of position attribute flag values
11	Initialized number	Char	00h-FFh	Increments with each initialization (modulo 256)

LLH

This message describes latitude, longitude, and height. It contains the following data:

- WGS-84 latitude and longitude, in radians
- WGS-84 height, in meters

Table B.4 Latitude, longitude, height (Type 2 record)

Field	Item	Type	Value	Meaning
0	Output record type	Char	02h	Latitude, longitude, and height output record
1	Record length	Char	18h	Bytes in record
2–9	Latitude	Double	Radians	Latitude from WGS-84 datum
10–17	Longitude	Double	Radians	Longitude from WGS-84 datum
18–25	Height	Double	Meters	Height from WGS-84 datum

ECEF

This message describes the ECEF position. It contains the following data:

- Earth-Centered, Earth-Fixed X, Y, Z coordinates, in meters

Table B.5 ECEF position (Type 3 record)

Field	Item	Type	Value	Meaning
0	Output record type	Char	03h	Earth-Centered, Earth-Fixed (ECEF) position output record
1	Record length	Char	18h	Bytes in record
2-9	X	Double	Meters	WGS-84 ECEF X-axis coordinate
10-17	Y	Double	Meters	WGS-84 ECEF Y-axis coordinate
18-25	Z	Double	Meters	WGS-84 ECEF Z-axis coordinate

ECEF DELTA

This message describes the ECEF Delta position. It contains the following data:

- Earth-Centered, Earth-Fixed X, Y, Z deltas between the rover and base position, in meters.

Table B.6 ECEF Delta (Type 6 record)

Field	Item	Type	Value	Meaning
0	Output record type	Char	06h	Earth-Centered, Earth-Fixed (ECEF) Delta output record
1	Record length	Char	18h	Bytes in record
2-9	Delta X	Double	Meters	ECEF X-axis delta between rover and base station positions
10-17	Delta Y	Double	Meters	ECEF Y-axis delta between rover and base station positions
18-25	Delta Z	Double	Meters	ECEF Z-axis delta between rover and base station positions

NEU DELTA

This message contains Tangent Plane Delta information. It contains the following data:

- North, East, and Up deltas of the vector from the base to the rover (in meters) projected onto a plane tangent to the WGS-84 ellipsoid at the base receiver.

Note – These records are only output if a valid DGPS/RTK solution is computed.

Table B.7 NEU Delta (Type 7 record)

Field	Item	Type	Value	Meaning
0	Output record type	Char	07h	Tangent Plane Delta output record
1	Record length	Char	18h	Bytes in record

Table B.7 NEU Delta (Type 7 record)

Field	Item	Type	Value	Meaning
2-9	Delta east	Double	meters	East component of vector from base station to rover, projected onto a plane tangent to the WGS-84 ellipsoid at the base station
10-17	Delta north	Double	meters	North component of tangent plane vector
18-25	Delta up	Double	meters	Difference between ellipsoidal height of tangent plane at base station and a parallel plane passing through rover point

Velocity

This message provides velocity information. It contains the following data:

- Horizontal velocity, in meters per second
- Vertical velocity, in meters per second
- Heading, in radians, referenced to WGS-84 True North

Table B.8 Velocity (Type 8 record)

Field	Item	Type	Value	Meaning
0	Output record type	Char	08h	Velocity data output record
1	Record length	Char	0Dh	Bytes in record
2	Velocity flags	Char	See Table B.20	Velocity status flags
3-6	Speed	Float	Meters per second	Horizontal speed
7-10	Heading	Float	Radians	True north heading in the WGS-84 datum
11-14	Vertical velocity	Float	Meters per second	Vertical velocity

PDOP

This message describes the PDOP information. It contains the following data:

- PDOP
- HDOP
- VDOP
- TDOP

Table B.9 PDOP (Type 9 record)

Field	Item	Type	Value	Meaning
0	Output record type	Char	09h	PDOP information output record
1	Record length	Char	10h	Bytes in record
2–5	PDOP	Float		Positional Dilution of Precision
6–9	HDOP	Float		Horizontal Dilution of Precision
10–13	VDOP	Float		Vertical Dilution of Precision
14–17	TDOP	Float		Time Dilution of Precision

SIGMA

This message describes the Position Sigma information. It contains the following data:

- Position RMS
- Sigma east, in meters
- Sigma north, in meters
- Sigma up, in meters
- Covariance east-north
- Error Ellipse Semi-major axis, in meters
- Error Ellipse Semi-minor axis, in meters
- Orientation of Semi-major axis in degrees from True North
- Unit variance
- Number of epochs

Table B.10 Sigma (Type 12 record)

Field	Item	Type	Value	Meaning
0	Output record type	Char	0Ch	Position sigma information output record
1	Record length	Char	26h	Bytes in record
2–5	Position RMS	Float		Root means square of position error calculated for overdetermined positions
6–9	Sigma east	Float	Meters	
10–13	Sigma north	Float	Meters	
14–17	Covar. east-north	Float	number	Covariance east-north (dimensionless)

Table B.10 Sigma (Type 12 record) (continued)

Field	Item	Type	Value	Meaning
18–21	Sigma up	Float	Meters	
22–25	Semi-major axis	Float	Meters	Semi-major axis of error ellipse
26–29	Semi-minor axis	Float	Meters	Semi-minor axis of error ellipse
30–33	Orientation	Float	degrees	Orientation of semi-minor axis, clockwise from True North
34–37	Unit variance	Float		Valid only for over-determined solutions. Unit variance should approach 1.0 value. A value of less than 1.0 indicates that apriori variances are too pessimistic.
30–39	Number of epochs	short	count	Number of measurement epochs used to compute the position. Could be greater than 1 for positions subjected to static constraint. Always 1 for kinematic.

SV Brief

This message provides brief satellite information. It contains the following data:

- Number of satellites tracked
- The PRN number of each satellite
- Flags indicating satellite status

Table B.11 SV brief (Type 13 record)

Field	Item	Type	Value	Meaning
0	Output record type	Char	0Dh	Brief satellite information output record
1	Record length	Char		Bytes in record
2	Number of SVs	Char	00h-18h	Number of satellites included in record ¹
	The following bytes are repeated for Number of SVs			
	PRN	Char	01h-20h	Pseudorandom number of satellites (1-32)
	SV Flags1	Char	See Table B.21	First set of satellite status bits
	SV Flags2	Char	See Table B.22	Second set of satellite status bits

¹Includes all tracked satellites, all satellites used in the position solution, and all satellites in view.

SV Detail

This message provides detailed satellite information. It contains the following data:

- Number of satellites tracked
- The PRN number of each satellite
- Flags indicating satellite status
- Elevation above horizon, in degrees
- Azimuth from True North, in degrees

- Signal-to-noise ratio (SNR) of L1 signal
- Signal-to-noise ratio (SNR) of L2 signal

Table B.12 SV detail (Type 14 record)

Field	Item	Type	Value	Meaning
0	Output record type	Char	0Eh	Detailed satellite information output record type
1	Record length	Char	1 + 8×(number of SVs)	Bytes in record
2–9	Number of SVs	Char	00h-18h	Number of satellites included in record ¹
The following bytes are repeated for Number of SVs				
	PRN	Char	01h-20h	Pseudorandom number of satellites (1–32)
	Flags1	Char	See Table B.21	First set of satellite status bits
	Flags2	Char	See Table B.22	Second set of satellite status bits
	Elevation	Char	Degrees	Angle of satellite above the horizon
	Azimuth	Short	Degrees	Azimuth of satellite from True North
	SNR L1	Char	dB * 4	Signal-to-noise ratio of L1 signal (multiplied by 4) ²
	SNR L2	Char	dB * 4	Signal-to-noise ratio of L2 signal (multiplied by 4) ²

¹Includes all tracked satellites, all satellites used in the position solution, and all satellites in view.

²The SNR L1 and SNR L2 items are set to zero for satellites that are not tracked on the current frequency.

UTC

This message describes current time information. It contains the following data:

- GPS time, in milliseconds of GPS week
- GPS week number
- GPS to UTC time offset, in seconds

Table B.13 UTC (Type 16 record)

Field	Item	Type	Value	Meaning
0	Output record type	Char	10h	
1	Record length	Char	09h	Bytes in record
2–5	GPS millisecond of week	Long	msecs	Time when packet is sent from the receiver, in GPS milliseconds of week
6–7	GPS week number	Short	number	Week number since start of GPS time
8–9	UTC offset	Short	seconds	GPS to UTC time offset
10	Flags	Char	See Table B.19	Flag bits indicating validity of Time and UTC offsets

Batt/Mem

This message provides information relating to the receiver battery and memory. It contains the following data:

- Remaining battery power
- Remaining memory

Table B.14 Batt/Mem (Type 37 record)

Field	Item	Type	Value	Meaning
0	Output record type	Char	25h	
1	Record length	Char	0Ah	Bytes in record
2-3	Battery capacity	Unsigned short	percentage	Remaining battery capacity in percentage
4-11	Remaining memory	Double	hours	Estimated remaining data logging time in hours

Attitude

This message provides attitude information relating to the vector between the Heading antenna and the Moving Base antenna. It contains the following data:

- Tilt or vertical angle, in radians, from the Heading antenna to the Moving Base antenna relative to a horizontal plane through the Heading antenna
- Heading or yaw, in radians, relative to True North
- Range or slope distance between the Heading antenna and the Moving Base antenna

Table B.15 Attitude (Type 27 record)

Field	Item	Type	Value	Meaning
0	Output record type	Char	1Bh	Attitude information
1	Record length	Char	2Ah	Bytes in record
2-5	GPS time	Long	msecs	GPS time in milliseconds of GPS week
6	Flags	Char	See Table B.23	Flag bits indicating validity of attitude components
7	Number of SVs used	Char	00h-0Ch	Number of satellites used to calculate attitude
8	Calculation mode	Char	See Table B.24	Positioning mode
9	Reserved			Reserved
10-17	Tilt	Double	radians	Tilt relative to horizontal plane
18-25	Yaw	Double	radians	Rotation about the vertical axis relative to True North
26-33	Reserved			Reserved
34-41	Range	Double	meters	Distance between antennas
42-43	PDOP	Short	0.1	Position Dilution of Precision

BASE POSITION AND QUALITY INDICATOR

This message describes the base station position and its quality. It is used when the moving base antenna position and quality are required on one serial port (along with a heading message) from a receiver in heading mode, typically the SPS551H.

Table B.16 Base position and quality indicator (Type 41 record)

Field	Item	Type	Value	Meaning
0	Output record type	Char	01h	Position time output record
1	Record length	Char	0Ah	Bytes in record
2-5	GPS time (ms)	Long	msecs	GPS time, in milliseconds of GPS week
6-7	GPS week number	Short	number	GPS week count since January 1980
8	Latitude	Double	Radians	The WGS-84 latitude, in radians, of the moving base antenna
9	Longitude	Double	Radians	The WGS-84 longitude, in radians, of the moving base antenna
10	Height	Double	Meters	The WGS-84 height, in meters, of the moving base antenna
11	Quality indicator	Char	See Table B.16	The quality of the base station position: 0: Fix not available or invalid 1: Autonomous GPS fix 2: Differential SBAS or OmniSTAR VBS 4: RTK Fixed 5: OmniSTAR XP, OmniSTAR HP, Float RTK, or Location RTK

Flags

Table B.17 Position flags 1: bit values

Bit	Meaning
0	New position 0: No. 1: Yes.
1	Clock fix calculated for current position 0: No. 1: Yes.
2	Horizontal coordinates calculated this position 0: No. 1: Yes.
3	Height calculated this position 0: No. 1: Yes.
4	Weighted position 0: No. 1: Yes.
5	Overdetermined position 0: No. 1: Yes.
6	Ionosphere-free position 0: No. 1: Yes.
7	Position uses filtered L1 pseudoranges 0: No. 1: Yes.

Table B.18 Position flags 2: bit values

Bit	Meaning
0	Differential position 0: Differential position is an autonomous or a WAAS solution. 1: Position is a differential solution.
1	Differential position method 0: Code 1: Phase including RTK, HP or XP OmniSTAR (VBS is not derived from Phase).
2	Differential position method 0: Code (DGPS) or a float position (RTK). Uncorrected position is Autonomous (if bit 0 = 0). 1: Position is fixed integer phase position (RTK). Uncorrected position is WAAS (if bit 0 = 0).
3	OmniSTAR solution 0: Not active 1: OmniSTAR differential solution (including HP, XP, and VBS)
4	Position determined with static as a constraint 0: No. 1: Yes.
5	Position is network RTK solution 0: No. 1: Yes.
6	Position is Location RTK 0: No. 1: Yes.
7	Reserved (set to zero)

Table B.19 Flags: Bit values

Bit	Meaning
0	Time information (week and millisecond of week) validity 0: Not valid 1: Valid
1	UTC offset validity 0: Not valid 1: Valid

Table B.20 Velocity flags: Bit values

Bit	Meaning
0	Velocity data validity 0: Not valid 1: Valid
1	Velocity computation 0: Computed from doppler 1: Computed from consecutive measurements
2–7	Reserved (set to zero)

Table B.21 SV flags: 1 bit values

Bit	Meaning
0	Satellite Above Horizon 0: No. 1: Yes.
1	Satellite Currently Assigned to a Channel (trying to track) 0: No. 1: Yes.
2	Satellite Currently Tracked on L1 Frequency 0: No. 1: Yes.
3	Satellite Currently Tracked on L2 Frequency 0: No. 1: Yes.
4	Satellite Reported at Base on L1 Frequency 0: No. 1: Yes.
5	Satellite Reported at Base on L2 Frequency 0: No. 1: Yes.
6	Satellite Used in Position 0: No. 1: Yes.
7	Satellite Used in Current RTK Process (Search, Propagate, Fix Solution) 0: No. 1: Yes.

Table B.22 SV flags: 2 bit value

Bit	Meaning
0	Satellite Tracking P-Code on L1 Band 0: No. 1: Yes.
1	Satellite Tracking P-Code on L2 Band 0: No. 1: Yes.
2–7	Reserved. Set to zero.

Table B.23 Attitude flags

Bit	Meaning
0	Calibrated 0: No. 1: Yes.
1	Tilt valid 0: No. 1: Yes.
2	Yaw valid 0: No. 1: Yes.
3	Reserved
4	Range valid 0: No. 1: Yes.
5-7	Reserved

Table B.24 Attitude calculation flags

Bit	Meaning
0	0: No position 1: Autonomous position 2: RTK/Float position 3: RTK/Fix position 4: DGPS position

Adding Internal Radio Frequencies

In this appendix:

- [Adding receive frequencies for the 450 MHz internal radio](#)

If you have the optional internal 450 MHz radio in your GPS receiver, use the WinFlash utility to add the relevant *receive* frequencies to the default list of frequencies. To install the WinFlash utility, see [Installing the WinFlash utility](#), page 162.

You can also use the web interface to add and manage receive 450 MHz frequencies.

If you have a receiver with the *transmit* option, Trimble must specify and configure the (FCC-approved) transmit broadcast frequencies at the factory. You cannot configure these yourself. If extra Transmit frequencies are obtained once you have your receiver, then contact your local Trimble authorized dealer to have the extra frequencies added. The dealer will provide you with a *Set* file, which you can transfer to the receiver using the WinFlash utility.

Adding receive frequencies for the 450 MHz internal radio

1. Start the WinFlash utility. The *Device Configuration* screen appears.
2. From the *Device type* list, select the appropriate receiver.
3. From the *PC serial port* field, select the serial (COM) port on the computer that the receiver is connected to.
4. Click **Next**. The *Operation Selection* dialog appears. The *Operations* list shows all of the supported operations for the selected device. A description of the selected operation is shown in the *Description* field.
5. Select **Configure Radio Settings** and then click **Next**. The *Internal Transceiver Configuration* dialog appears:
6. In the *Wireless Format* group, select the appropriate channel and wireless mode. The Wireless mode must be the same for all radios in your network.
7. In the *Specify Frequency* field, enter the frequency you want to add.
8. Click **Add**. The new frequency appears in the *Selected Frequencies* list.

Note – The programmed frequencies must conform to the channel spacing and minimum tuning requirements for the radio. To view this information, click **Radio Info**. You can select 12.5 kHz or 25 kHz channel

spacing. All radios in your network must use the same channel spacing.

9. Once you have configured all the frequencies that you require, click **OK**.
The WinFlash utility updates the receiver radio frequencies and then restarts the receiver.

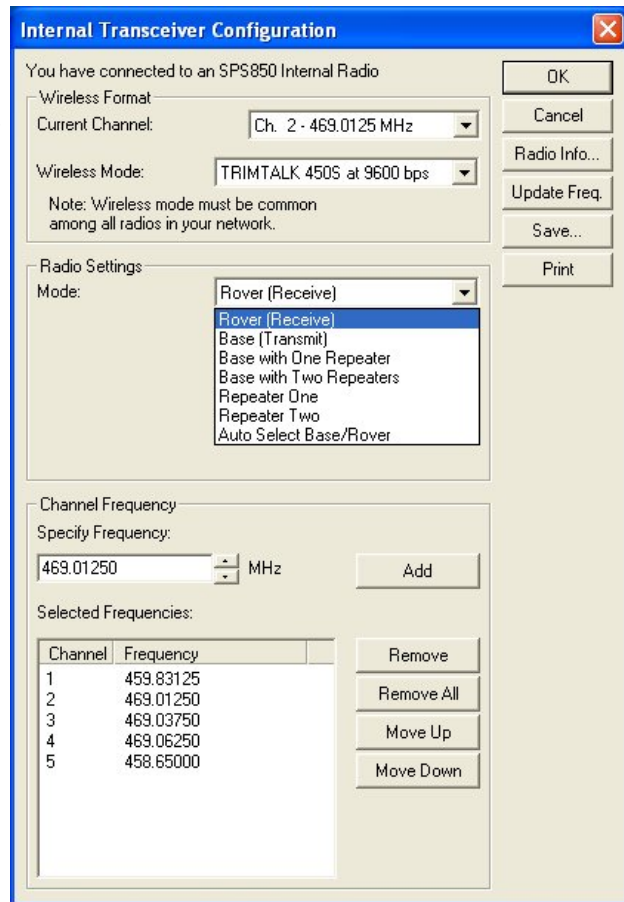

Setting UHF reception radio frequencies using the web interface

To enter your own Receive (Rx) frequency using the web interface:

1. Select the *Radio* menu.
2. Select the *Frequency Management* submenu:



3. Make a note of the details shown in the *Frequency range* and *Tuning step* fields. Any new frequencies must be within the range shown and must also be a multiple of the Khz shown in the *Tuning step* field.
4. Select the *Add Channel* option and then enter the new channel frequency.
5. Click **OK**.

To delete a channel frequency:

1. Select the *Delete channel* option.
2. Select a channel to delete from the list that appears.

You cannot add or delete Transmit channels using the web interface.

Transmitting Corrections

In this chapter:

- Scenario 1: Outputting corrections using an HPB450 radio-modem
- Scenario 2: Outputting corrections using a TRIMMARK 3 radio
- Scenario 3: Outputting corrections from a SNB900 radio to an HPB450 or TRIMMARK 3 radio

This chapter details how to transmit corrections over a construction site through 900 MHz and 450 MHz radios from the same base station. Three scenarios and the solutions to each are explained.

Scenario 1: Outputting corrections using an HPB450 radio-modem

A Construction base station such as the SPS851 has an internal 900 MHz radio and you want to also transmit corrections on a Trimble HPB450 radio-modem connected to the SPS851 receiver.

Solution

The HPB450 radio comes with a 5-pin Lemo to 7-pin Lemo connector with a power connection lead:

1. Connect the 7-pin Lemo connector to the connector on the receiver.
2. Connect the 5-pin Lemo connector to the HPB450 radio.
3. Connect the DC power lead to an external power source.
4. Turn on the HPB450 radio.

If the HPB450 radio has the 5-pin Lemo connector to 9-pin D-sub connector cable:

1. Connect the 9-pin D connector to the 26-pin to 9-pin D-sub adaptor on the receiver.
2. Connect the 5-pin Lemo connector to the HPB450 radio.
3. Connect the DC power lead to an external power source.
4. Turn on the HPB450 radio.

To configure the system, do one of the following:

- Use the Trimble SCS900 Site Controller software to connect to the receiver. Set up the base station with the external radio. The SCS900 software will locate the HPB450 radio and then allow you to set the radio channel. Then, use the front panel of the receiver to select Radio and Lemo (R+L) to then turn on the internal 900 MHz radio transmissions. If using the 9-pin D-sub connector, select Radio and Modem Port (R+M).
- Use the web interface to access the SPS851 setup. Select *I/O Configuration / Port Configuration*. Select the *Serial 1 / Lemo* option and select corrections to be sent on the Lemo port at those baud rate settings (the HPB450 serial interface is shipped with the default rates 38400 8/N/1). While in the *Port Configuration* menu, also set the internal radio to transmit corrections.
- Use the front panel of the receiver to set up the Lemo port and to select the radio on which to output the data (shown as R+L or R+M on the receiver display).

Configuration software accompanies the HPB450 radio if you need to change the serial connection baud rate.

Scenario 2: Outputting corrections using a TRIMMARK 3 radio

A Construction base station such as the SPS851 has an internal 900 MHz radio and you want to transmit corrections on a Trimble TRIMMARK 3 radio connected to the SPS851 receiver.

Solution

The TRIMMARK 3 radio comes with both a 7-pin Lemo to 7-pin Lemo cable and a 7-pin Lemo to 9-pin D-sub cable.

To connect the TRIMMARK 3 radio to the SPS851 receiver, do one of the following:

- Use the 7-pin Lemo (SPS851) to 7-pin Lemo (TRIMMARK 3) cable.
- Use the Lemo-to-Lemo cable.
- Use the 7-pin Lemo to 9-pin D-sub cable and then connect to the Modem port (9-pin D-sub connector) on the SPS851 adaptor.

To configure the system, do one of the following:

- Use the SCS900 Site Controller software to connect to the receiver (either by cable or Bluetooth wireless technology). Start the base station and then configure RTK messages to be transmitted through an external radio. The SCS900 software will locate the TRIMMARK 3 radio and then allow you to set the radio channel. Then, use the front panel of the receiver to select Radio and Lemo (R+L) or (R+M) to turn on the internal 900 MHz radio transmissions.
- Use the web interface to access the SPS851 setup. Select *I/O Configuration / Port Configuration*. Select the *Serial 1 / Lemo* option and select corrections to be sent on the Lemo port at those baud rate settings. If using 9-pin D-sub, then use the Modem port. While in the *Port Configuration* menu, also set the internal radio to transmit corrections.
- Use the front panel of the receiver to set up the Lemo port and to select the radio on which to output the data (shown as R+L or R+M on the receiver display).

Scenario 3: Outputting corrections from a SNB900 radio to an HPB450 or TRIMMARK 3 radio

Output corrections from the Trimble SNB900 radio through the Lemo port to an HPB450 or TRIMMARK 3 radio. This is especially useful when using a Smart GPS antenna such as the Trimble SPS881 and the construction site requires dual frequencies (450 MHz and 900 MHz) to be broadcast.

Solution

To configure the system:

1. Use a cable to connect the SNB900 radio-modem (Lemo Port) to the SPS881 Smart GPS antenna.
2. Use the SCS900 software to output the corrections to the external SNB900 radio-modem.
3. Connect the HPB450 or TRIMMARK 3 radio to the Modem port of the SNB900 radio-modem.
4. From the front panel of the SNB900 radio-modem, set output to both Radio and Lemo.

Real-Time Data and Services

In this appendix:

- [RT17 Streamed Data service](#)
- [Login authentication](#)

The real-time Binary Output option (also known as RT17 messages or raw data) is available as an optional upgrade. The RT17 Streamed Data service is available only with the SPS751 Max and the SPS851 GPS receivers.

By default, the Binary Output option is not enabled in the GPS receivers. The option must be enabled before RT17 messages can be streamed from the receiver. To enable the option, please contact your local Trimble dealer.

RT17 Streamed Data service

An RT17 service provides GPS observations, ephemerides, and other information, as defined for that service. When a “client” connects to the service, all data flow is from the receiver to the client.

Using the keypad and display to configure RT17 outputs

You can configure RT17 output during the base and rover setup using the keypad and display. See [Outputting corrections, page 67](#).

Using the web interface to configure RT17 outputs

You can configure RT17 output using the *I/O Configuration* menu of the web interface of the receiver. Configure the stream to allow multiple client connections on a single port, or restrict the stream to a single client connection. To allow only authorized connections on the port, protect the output stream by requiring a password. See [I/O Configuration menu, page 91](#).

Login authentication

If you interface to the receivers using binary commands over serial communications, you may need login authentication. This has been added to most receiver models that run firmware version 3.30 or later.

If your utilities such as the WinFlash utility or the Configuration ToolBox software do not work with the receivers running firmware version 3.30 or later, go to the Trimble website and then download the latest versions of these utilities. If your own application software no longer communicates with the receiver, please contact Trimble Support for information about how to use the receiver in these cases.

Upgrading the Receiver Firmware

In this appendix:

- [The WinFlash utility](#)
- [Upgrading the receiver firmware](#)
- [Forcing the receiver into Monitor mode](#)

The GPS receiver is supplied with the latest version of the receiver firmware already installed. If a later version of the firmware becomes available, use the WinFlash utility to upgrade the firmware on your receiver.

You can also upgrade the receiver through the web interface (see [Configuring the receiver using a web browser, page 77](#)). If your receiver has access to the Internet, then whenever Trimble releases new firmware your receiver will check and display the new firmware version number in the Web browser. You can then decide to install the newer firmware from the Web browser.

Firmware updates are available to download from the Trimble website. Go to www.trimble.com/support.shtml and select the link to the receiver that you need updates for and then click Downloads.

The WinFlash utility

The WinFlash utility communicates with Trimble products to perform various functions including:

- installing software, firmware, and option upgrades
- running diagnostics (for example, retrieving configuration information)
- configuring radios

For more information, online help is also available when using the WinFlash utility.

Note – *The WinFlash utility runs on Microsoft Windows 95, 98, Windows NT®, 2000, Me, or XP operating systems.*

Installing the WinFlash utility

You can install the WinFlash utility from the *Trimble SPS GPS Receiver CD*, or from the Trimble website.

To install the WinFlash utility from the CD:

1. Insert the disk into the CD drive on your computer.
2. From the main menu select *Install individual software packages*.
3. Select *Install WinFlash*.
4. Follow the on-screen instructions.

The WinFlash utility guides you through the firmware upgrade process, as described below. For more information, refer to the WinFlash Help.

Upgrading the receiver firmware

1. Start the WinFlash utility. The *Device Configuration* screen appears.
2. From the *Device type* list, select your receiver.
3. From the *PC serial port* field, select the serial (COM) port on the computer that the receiver is connected to.
4. Click **Next**.

The *Operation Selection* screen appears. The *Operations* list shows all of the supported operations for the selected device. A description of the selected operation is shown in the *Description* field.

5. Select *Load GPS software* and then click **Next**.

The *GPS Software Selection* window appears. This screen prompts you to select the software that you want to install on the receiver.

6. From the *Available Software* list, select the latest version and then click **Next**.

The *Settings Review* window appears. This screen prompts you to connect the receiver, suggests a connection method, and then lists the receiver configuration and selected operation.

7. If all is correct, click **Finish**.

Based on the selections shown above, the *Software Upgrade* window appears and shows the status of the operation (for example, **Establishing communication with <your receiver>. Please wait.**).

8. Click **OK**.

The *Software Upgrade* window appears again and states that the operation was completed successfully.



9. To select another operation, click **Menu**; to quit, click **Exit**.

If you click **Exit**, the system prompts you to confirm.

10. Click **OK**.

Forcing the receiver into Monitor mode

If the receiver will not go into Monitor mode to load new firmware, complete the following steps:

1. Turn off the receiver.
2. Press and hold  while turning on the receiver.
3. Continue to hold the  button as the display shows the countdown timer.
4. Once the display shows **Remote Monitor Active:1**, release the  button.
5. The receiver is forced into Monitor mode and you can load the new firmware.

Troubleshooting

In this appendix:



- [Receiver issues](#)

Use this appendix to identify and solve common problems that may occur with the receiver.

Please read this section before you contact Technical Support.

Receiver issues

This section describes some possible receiver issues, possible causes, and how to solve them.

Issue	Possible cause	Solution
The receiver does not turn on.	External power is too low.	Check the charge on the external battery and, if applicable, check the fuse.
	Internal power is too low.	Check the charge on the internal battery.
	External power is not properly connected.	Check that the Lemo connector or 26-pin adaptor is seated correctly, and that the cable is secured to the receiver. Check for broken or bent pins in the connector.
	Faulty power cable.	Check that you are using the correct cable for the port/battery. Check that the correct battery is connected to a particular port. The ports on the GPS receiver are optimized for use with different types of battery. The 26-pin connector is optimized for Trimble custom external batteries, and the Lemo port is optimized for external 12 V batteries such as car, motorcycle, or truck batteries. If the wrong type of battery is connected to a port, it is likely that it will cut off earlier than normal. Check pinouts with a multimeter to ensure internal wiring is intact.
Receiver does not log data.	Insufficient memory.	Delete old files. Do one of the following: <ul style="list-style-type: none"> • Press  for 35 seconds. • Use the delete and purge functions in the <i>Data Logging</i> menu of the web interface.
	Data Logging option is disabled.	Order the Data Logging option from your local Trimble dealer. By default, data logging is disabled on all SPS GPS receivers. To see if data logging is enabled on your receiver, check your original purchase order or the receiver configuration using the web interface.
	The receiver is tracking fewer than four satellites.	Wait until the receiver display shows that more than four satellites are being tracked.
	The internal memory needs to be reformatted	Press  for 35 seconds.
The receiver is not responding.	Receiver needs a soft reset.	Turn off the receiver and then turn it back on again.
	Receiver needs a full reset.	Press  for 35 seconds.

Issue	Possible cause	Solution
<p>The base station receiver is not broadcasting.</p>	<p>Port settings between reference receiver and radio are incorrect.</p>	<p>Using the SCS900 Site Controller software, connect to the reference radio through the receiver. If no connection is made, connect directly to the radio and change the port settings. Try to connect through the receiver again to ensure that they are communicating.</p>
	<p>Corrections are routed to a port rather than to the internal radio modem.</p>	<p>Check that corrections are routed correctly using the receiver keypad and display.</p>
	<p>A rubber duck antenna is connected directly to the radio antenna port on the receiver, or an external high-gain antenna is connected through a cable to the radio antenna port on the receiver.</p>	<p>Check that the connections are made correctly and to the right connectors. Ensure that the connectors are seated tightly and that there are no signs of damage to the cable.</p>
	<p>You are using AutoBase and the AutoBase Warning function is enabled.</p>	<p>If you set up on a new point on a site that has not been occupied previously, the AutoBase Warning will prohibit the base station from broadcasting.</p>
	<p>Faulty cable between receiver and radio.</p>	<p>Try a different cable. Examine the ports for missing pins. Use a multimeter to check pinouts.</p>
<p>Rover receiver is not receiving radio.</p>	<p>No power to radio.</p>	<p>If the radio has its own power supply, check the charge and connections.</p>
	<p>The base station receiver is not broadcasting.</p>	<p>See the issue, The base station receiver is not broadcasting, above.</p>
	<p>Incorrect over air baud rates between reference and rover.</p>	<p>Connect to the rover receiver radio, and make sure that it has the same setting as the reference receiver. The SCS900 software automatically configures the over-the-air baud rate to 9600.</p>
	<p>Incorrect port settings between roving external radio and receiver.</p>	<p>If the radio is receiving data and the receiver is not getting radio communications, use the SCS900 software to check that the port settings are correct.</p>
<p>The radio antenna cable and GPS antenna cable are not correctly connected.</p>	<p>Make sure that the external radio antenna cable is connected between the TNC connector marked RADIO and the radio antenna.</p>	

Issue	Possible cause	Solution
The receiver is not receiving satellite signals	The GPS antenna is connected to the wrong antenna connector.	Make sure that the GPS antenna cable is tightly seated in the GPS antenna connection on the receiver and not connected to the wrong/radio antenna connector.
	The GPS antenna cable is loose.	Make sure that the GPS antenna cable is tightly seated in the GPS antenna connection on the GPS antenna.
	The cable is damaged.	Check the cable for any signs of damage. A damaged cable can inhibit signal detection from the antenna at the receiver.
	The GPS antenna is not in clear line of sight to the sky.	<ul style="list-style-type: none"> • Make sure that the GPS antenna is located with a clear view of the sky. • Restart the receiver as a last resort (turn off and then turn it on again).
The message PC Loader in Control appears on the front panel	The WinFlash utility is in use.	Complete the WinFlash task and then exit the utility.
	The WinFlash utility was started then the data cable was disconnected.	Plug the data cable back in and then restart the receiver.
	No apparent reason.	<ul style="list-style-type: none"> • If the WinFlash utility is not in use, turn off the receiver using the Power key. • If that does not turn it off, apply external DC power and hold down the Power key for 60 seconds.
The message Remote Monitor active appears on the front panel	Internet software	<ul style="list-style-type: none"> • If possible, turn off the receiver. • If possible, reload the current firmware. • If the above solutions do not resolve this, leave the receiver on with no external power, so the internal battery completely discharges. Then, turn on the receiver.

Drawings

In this appendix:

- [Back view](#)
- [Side view](#)
- [Bottom view](#)

The drawings in this appendix show the dimensions of the receiver. Refer to these drawings if you need to build mounting brackets and housings for the receiver.

The dimensions shown in these drawings are inches, with millimeters shown in brackets.

Back view

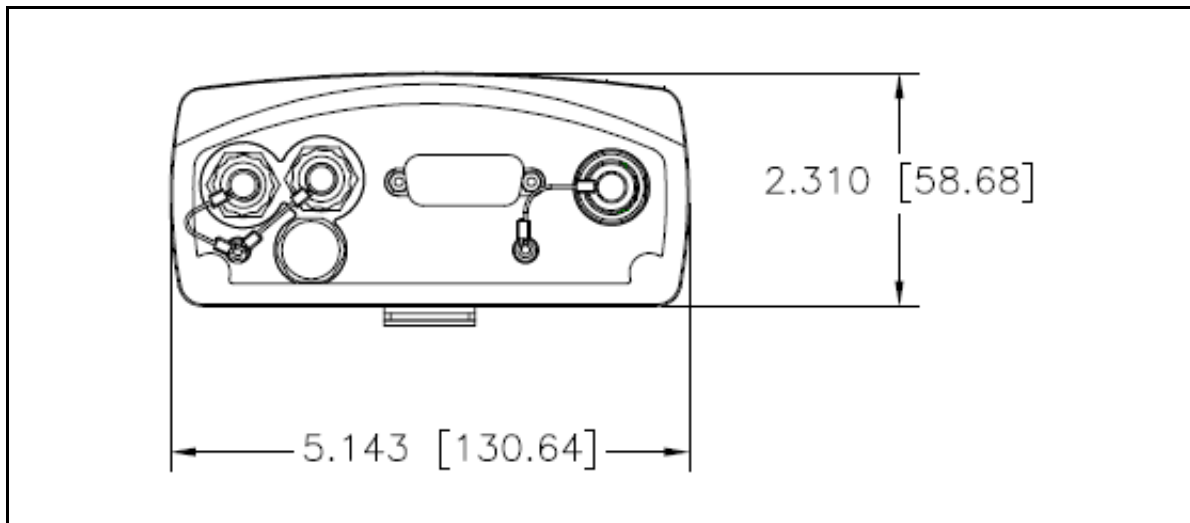

Side view

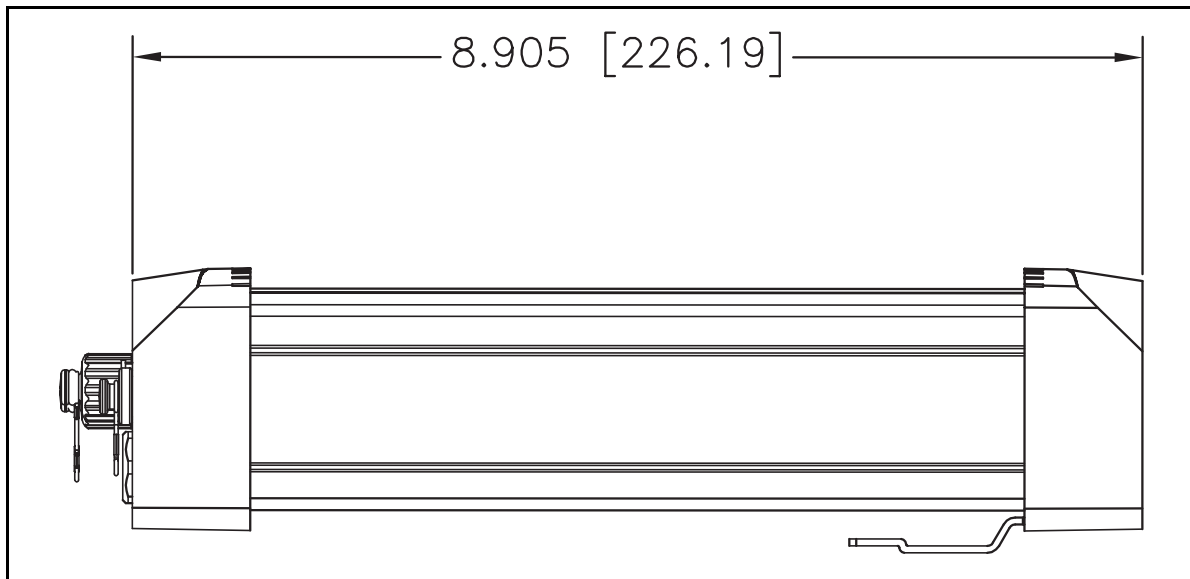

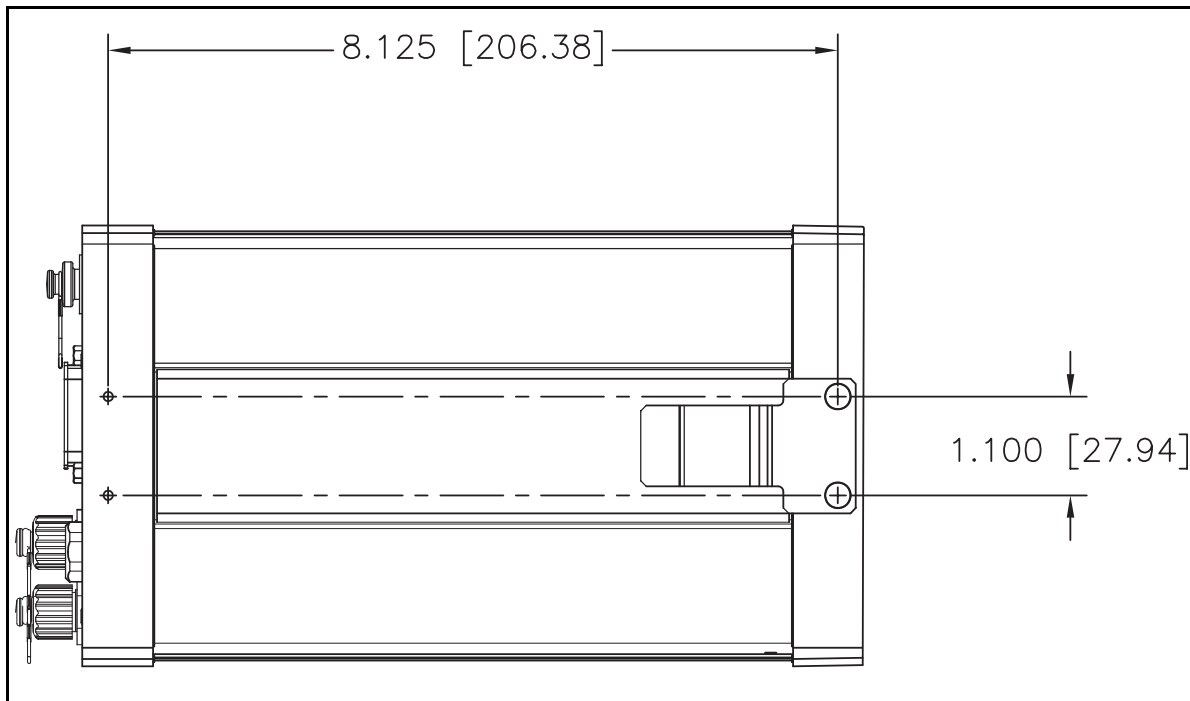
Bottom view

Receiver Connector Pinout Information

In this appendix:

- [Lemo connector](#)
- [Modem multi-function port](#)
- [1PPS and ASCII time tag](#)
- [ASCII time tag](#)
- [26-Pin D-sub connector wiring chart \(P/N 60789-00\)](#)

The receivers have a wide range of interfacing options. There are a large number of adaptors and cables available from Trimble that provide most of the common interfacing combinations.

The receiver has two connectors:

- a zero shell 7-pin Lemo connector
- a high-density 26-pin D-sub connector

Lemo connector

The lemo connector is a 7-pin 0-shell Lemo connector.

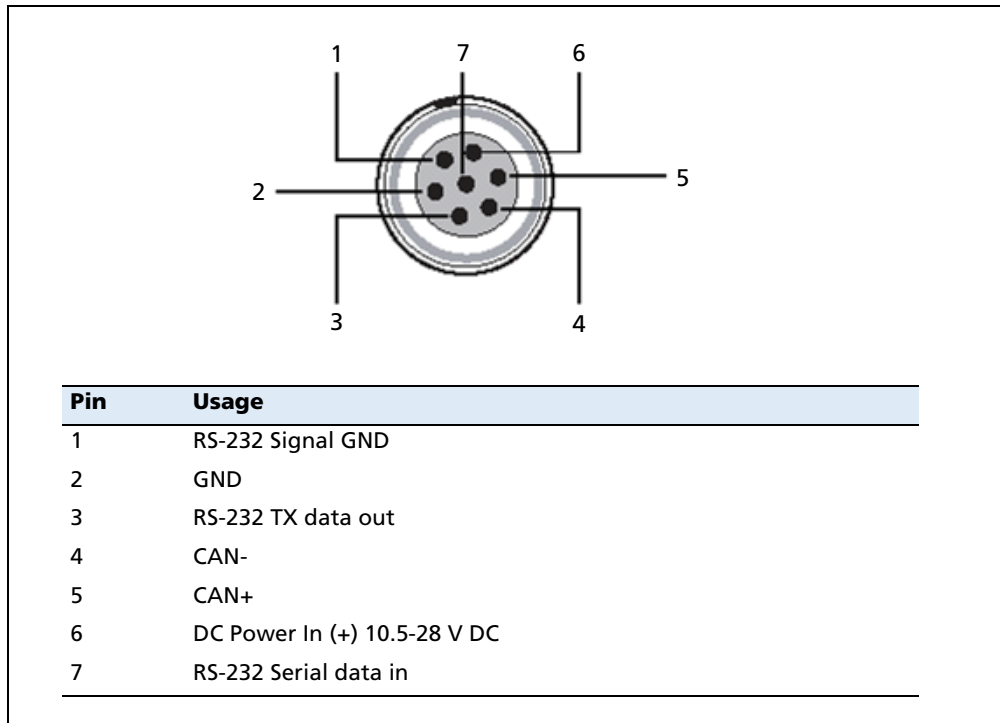

Modem multi-function port

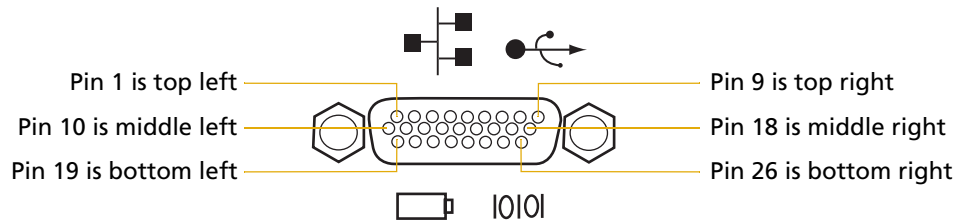

Pin	Usage
1	RS-232 Modem port data terminal ready (DTR)
2	RS-232 Modem port clear to send (CTS)
3	RS-232 Modem port Data Set Ready (DSR)
4	RS-232 Modem port Data Carrier Detect (DCD)
5	RS-232 Modem port Ring Indicator (RI)
6	GND
7	RS-232 Modem port 2 Transmit Data (TX)
8	RS-232 Modem port 2 Receive Data (RX)
9	USB+
10	Ethernet Ground (ET_GND RJ45 Pin 4)
11	RS-232 Modem port Ready to Send (TX)
12	RS-232 Modem port Transmit Data (TX)
13	Ethernet Ground (GND RJ45 Pin 5)
14	Ethernet Ground (GND RJ45 Pin 8)
15	USB ID
16	Ethernet Receive Data+ (RD-RJ45 Pin 6)
17	Ethernet Transmit Data+ (RD-RJ45 Pin 2)
18	USB-
19	USB Power
20	1PPS
21	RS-232 Modem Port Receive Data (RX)
22	Ethernet Ground (GND RJ45 Pin 7)
23	GND
24	DC Power In 9–28 V DC
25	Ethernet Receive Data+ (RD+, RJ45 Pin 3)
26	Ethernet Transmit Data+ (TD+, RJ45 Pin 1)

1PPS and ASCII time tag

The SPSx51 receiver can output a 1 pulse-per-second (1PPS) time strobe and an associated time tag message. The time tags are output on a user-selected port.

The leading edge of the pulse coincides with the beginning of each UTC second. The pulse is driven between nominal levels of 0.0 V and 5.0 V (see [Figure I.1](#)). The leading edge is positive (rising from 0 V to 5 V).

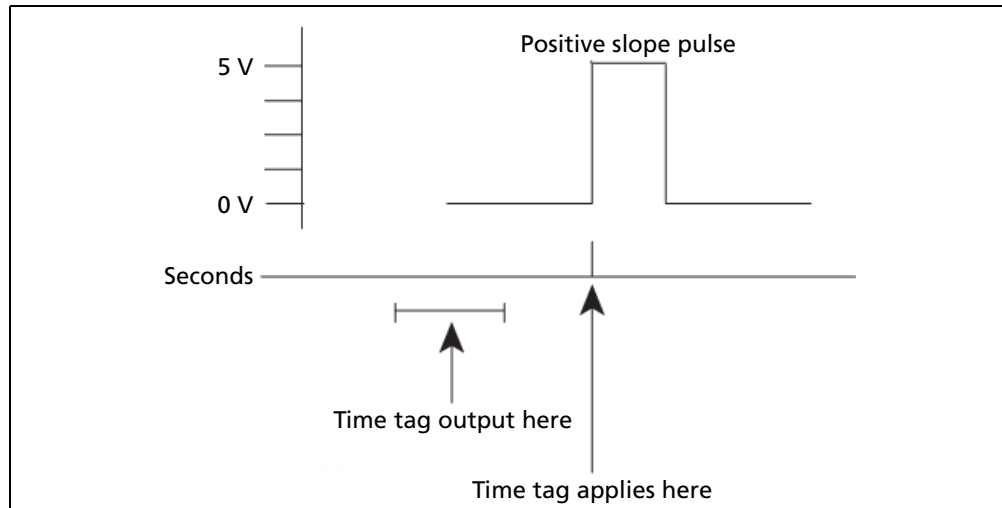

Figure I.1 Time tag relation to 1PPS wave form

The pulse is about 8 microseconds wide, with rise and fall times of about 100 nsec. Resolution is approximately 40 nsec, but the following external factor limits accuracy to approximately ± 1 microsecond:

- Antenna cable length

Each meter of cable adds a delay of about 2 nsec to satellite signals, and a corresponding delay in the 1PPS pulse.

1PPS is available on pin 20 on the back connector of the receiver. If you have applications that require 1PPS, Trimble recommends that you use cable P/N 60789-00 because it has the following connectors:

- D9 port for modem 1/serial 2.
- D9 port for modem 2/serial 3. Pin 9 on this D9 port has 1PPS.
- BNC connector for 1PPS.
- Ethernet male plug for connection to receiver.
- USB plug.
- DC jack for supplying power to the receiver.

ASCII time tag

Each time tag is output about 0.5 second before the corresponding pulse. Time tags are in ASCII format on a user-selected serial port. The format of a time tag is:

UTC *yy.mm.dd hh:mm:ss ab*

Where:

- UTC is fixed text.
- *yy.mm.dd* is the year, month, and date.
- *hh:mm:ss* is the hour (on a 24-hour clock), minute, and second. The time is in UTC, not GPS.
- *a* is an integer number representing the position-fix type:
 - 1 = time only
 - 2 = 1D & time
 - 3 = currently unused
 - 4 = 2D & time
 - 5 = 3D & time
- *b* is the number of GPS satellites being tracked.
- Each time tag is terminated by a *carriage return, line feed* sequence. A typical printout looks like:

UTC 02.12.21 20:21:16 56

UTC 02.12.21 20:21:17 56

UTC 02.12.21 20:21:18 56

Note – *If the receiver is not tracking satellites, the time tag is based on the receiver clock. In this case, a and b are represented by "??". The time readings from the receiver clock are less accurate than time readings determined from the satellite signals.*

26-Pin D-sub connector wiring chart (P/N 60789-00)

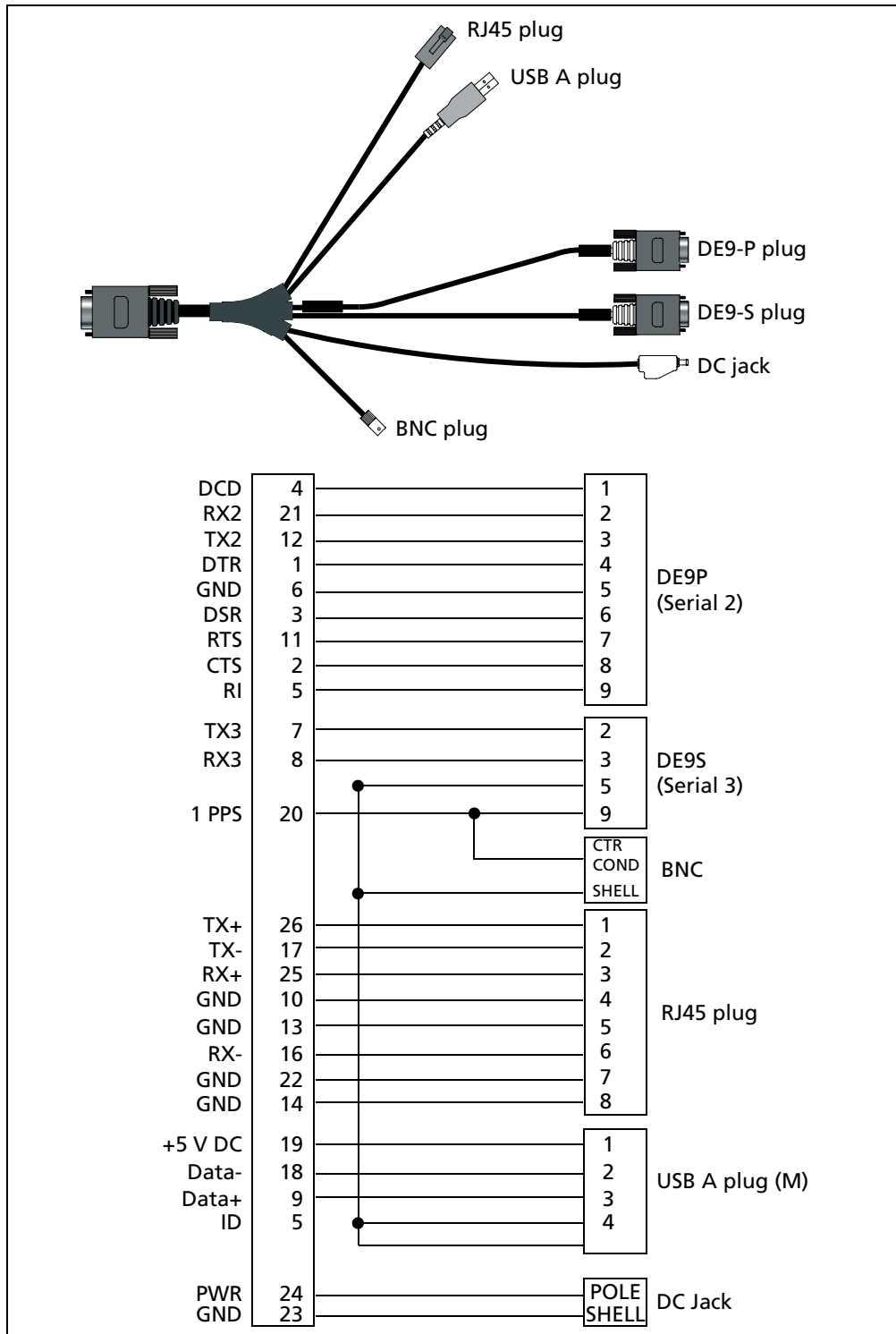

Glossary

IPPS	Pulse-per-second. Used in hardware timing. A pulse is generated in conjunction with a time stamp. This defines the instant when the time stamp is applicable.
almanac	A file that contains orbit information on all the satellites, clock corrections, and atmospheric delay parameters. The almanac is transmitted by a GPS satellite to a GPS receiver, where it facilitates rapid acquisition of GPS signals when you start collecting data, or when you have lost track of satellites and are trying to regain GPS signals. The orbit information is a subset of the ephemeris / ephemerides data.
AutoBase	AutoBase technology uses the position of the receiver to automatically select the correct base station; allowing for one button press operation of a base station. It shortens setup time associated with repeated daily base station setups at the same location on jobsites.
base station	Also called <i>reference station</i> . A base station in construction, is a receiver placed at a known point on a jobsite that tracks the same satellites as an RTK rover, and provides a real-time differential correction message stream through radio to the rover, to obtain centimeter level positions on a continuous real-time basis. A base station can also be a part of a virtual reference station network, or a location at which GPS observations are collected over a period of time, for subsequent postprocessing to obtain the most accurate position for the location.
BINEX	Binary EXchange format. BINEX is an operational binary format standard for GPS/GLONASS/SBAS research purposes. It has been designed to grow and allow encapsulation of all (or most) of the information currently allowed for in a range of other formats.
broadcast server	An Internet server that manages authentication and password control for a network of VRS servers, and relays VRS corrections from the VRS server that you select.
carrier	A radio wave having at least one characteristic (such as frequency, amplitude, or phase) that can be varied from a known reference value by modulation.
carrier frequency	The frequency of the unmodulated fundamental output of a radio transmitter. The GPS L1 carrier frequency is 1575.42 MHz.
carrier phase	Is the cumulative phase count of the GPS or GLONASS carrier signal at a given time.
cellular modems	A wireless adaptor that connects a laptop computer to a cellular phone system for data transfer. Cellular modems, which contain their own antennas, plug into a PC Card slot or into the USB port of the computer and are available for a variety of wireless data services such as GPRS.
CMR CMR+	Compact Measurement Record. A real-time message format developed by Trimble for broadcasting corrections to other Trimble receivers. CMR is a more efficient alternative to RTCM .
covariance	A statistical measure of the variance of two random variables that are observed or measured in the same mean time period. This measure is equal to the product of the deviations of corresponding values of the two variables from their respective means.

datum	<p>Also called <i>geodetic datum</i>. A mathematical model designed to best fit the geoid, defined by the relationship between an ellipsoid and, a point on the topographic surface, established as the origin of the datum. World geodetic datums are typically defined by the size and shape of an ellipsoid and the relationship between the center of the ellipsoid and the center of the earth.</p> <p>Because the earth is not a perfect ellipsoid, any single datum will provide a better model in some locations than in others. Therefore, various datums have been established to suit particular regions.</p> <p>For example, maps in Europe are often based on the European datum of 1950 (ED-50). Maps in the United States are often based on the North American datum of 1927 (NAD-27) or 1983 (NAD-83).</p> <p>All GPS coordinates are based on the WGS-84 datum surface.</p>
deep discharge	<p>Withdrawal of all electrical energy to the end-point voltage before the cell or battery is recharged.</p>
DGPS	<p>See real-time differential GPS.</p>
differential correction	<p>Differential correction is the process of correcting GPS data collected on a rover with data collected simultaneously at a base station. Because the base station is on a known location, any errors in data collected at the base station can be measured, and the necessary corrections applied to the rover data.</p> <p>Differential correction can be done in real-time, or after the data has been collected by postprocessing.</p>
differential GPS	<p>See real-time differential GPS.</p>
DOP	<p>Dilution of Precision. A measure of the quality of GPS positions, based on the geometry of the satellites used to compute the positions. When satellites are widely spaced relative to each other, the DOP value is lower, and position accuracy is greater. When satellites are close together in the sky, the DOP is higher and GPS positions may contain a greater level of error.</p> <p>PDOP (Position DOP) indicates the three-dimensional geometry of the satellites. Other DOP values include HDOP (Horizontal DOP) and VDOP (Vertical DOP), which indicate the accuracy of horizontal measurements (latitude and longitude) and vertical measurements respectively. PDOP is related to HDOP and VDOP as follows: $PDOP^2 = HDOP^2 + VDOP^2$</p>
dual-frequency GPS	<p>A type of receiver that uses both L1 and L2 signals from GPS satellites. A dual-frequency receiver can compute more precise position fixes over longer distances and under more adverse conditions because it compensates for ionospheric delays.</p>
EGNOS	<p>European Geostationary Navigation Overlay Service. A satellite-based augmentation system (SBAS) that provides a free-to-air differential correction service for GPS. EGNOS is the European equivalent of WAAS, which is available in the United States.</p>
elevation mask	<p>The angle below which the receiver will not track satellites. Normally set to 10 degrees to avoid interference problems caused by buildings and trees, atmospheric issues, and multipath errors.</p>
ellipsoid	<p>An ellipsoid is the three-dimensional shape that is used as the basis for mathematically modeling the earth's surface. The ellipsoid is defined by the lengths of the minor and major axes. The earth's minor axis is the polar axis and the major axis is the equatorial axis.</p>

ephemeris / ephemerides	A list of predicted (accurate) positions or locations of satellites as a function of time. A set of numerical parameters that can be used to determine a satellite's position. Available as broadcast ephemeris or as postprocessed precise ephemeris.
epoch	The measurement interval of a GPS receiver. The epoch varies according to the measurement type: for real-time measurement it is set at one second; for postprocessed measurement it can be set to a rate of between one second and one minute. For example, if data is measured every 15 seconds, loading data using 30-second epochs means loading every alternate measurement.
feature	A feature is a physical object or event that has a location in the real world, which you want to collect position and/or descriptive information (attributes) about. Features can be classified as surface or non-surface features, and again as points, lines/breaklines, or boundaries/areas.
firmware	The program inside the receiver that controls receiver operations and hardware.
GLONASS	Global Orbiting Navigation Satellite System. GLONASS is a Soviet space-based navigation system comparable to the American GPS system. The operational system consists of 21 operational and 3 non-operational satellites in 3 orbit planes.
GNSS	Global Navigation Satellite System.
GSOFF	General Serial Output Format. A Trimble proprietary message format.
HDOP	Horizontal Dilution of Precision. HDOP is a DOP value that indicates the accuracy of horizontal measurements. Other DOP values include VDOP (vertical DOP) and PDOP (Position DOP). Using a maximum HDOP is ideal for situations where vertical precision is not particularly important, and your position yield would be decreased by the vertical component of the PDOP (for example, if you are collecting data under canopy).
L1	The primary L-band carrier used by GPS and GLONASS satellites to transmit satellite data.
L2	The secondary L-band carrier used by GPS and GLONASS satellites to transmit satellite data.
L2C	A modernized code that allows significantly better ability to track the L2 frequency.
L5	The third L-band carrier used by GPS satellites to transmit satellite data. L5 will provide a higher power level than the other carriers. As a result, acquiring and tracking weak signals will be easier.
Moving Base	Moving Base is an RTK positioning technique in which both reference and rover receivers are mobile. Corrections are sent from a "base" receiver to a "rover" receiver and the resultant baseline (vector) has centimeter-level accuracy.
MSAS	MTSAT Satellite-Based Augmentation System. A satellite-based augmentation system (SBAS) that provides a free-to-air differential correction service for GPS. MSAS is the Japanese equivalent of WAAS , which is available in the United States.
multipath	Interference, similar to ghosts on an analog television screen, that occurs when GPS signals arrive at an antenna having traversed different paths. The signal traversing the longer path yields a larger pseudorange estimate and increases the error. Multiple paths can arise from reflections off the ground or off structures near the antenna.
NMEA	National Marine Electronics Association. NMEA 0183 defines the standard for interfacing marine electronic navigational devices. This standard defines a number of 'strings' referred to as NMEA strings that contain navigational details such as positions. Most Trimble GPS receivers can output positions as NMEA strings.

OmniSTAR	The OmniSTAR HP/XP service allows the use of new generation dual-frequency receivers with the OmniSTAR service. The HP/XP service does not rely on local reference stations for its signal, but utilizes a global satellite monitoring network. Additionally, while most current dual-frequency GPS systems are accurate to within a meter or so, OmniSTAR with XP is accurate in 3D to better than 30 cm.
PDOP	<p>Position Dilution of Precision. PDOP is a DOP value that indicates the accuracy of three-dimensional measurements. Other DOP values include VDOP (vertical DOP) and HDOP (Horizontal Dilution of Precision).</p> <p>Using a maximum PDOP value is ideal for situations where both vertical and horizontal precision are important.</p>
postprocessing	Postprocessing is the processing of satellite data after it has been collected, in order to eliminate error. This involves using computer software to compare data from the rover with data collected at the base station.
real-time differential GPS	<p>Also known as <i>real-time differential correction</i> or <i>DGPS</i>. Real-time differential GPS is the process of correcting GPS data as you collect it. Corrections are calculated at a base station and then sent to the receiver through a radio link. As the rover receives the position it applies the corrections to give you a very accurate position in the field. Most real-time differential correction methods apply corrections to code phase positions.</p> <p>While DGPS is a generic term, its common interpretation is that it entails the use of single-frequency code phase data sent from a GPS base station to a rover GPS receiver to provide sub-meter position accuracy. The rover receiver can be at a long range (greater than 100 kms (62 miles)) from the base station.</p>
rover	A rover is any mobile GPS receiver that is used to collect or update data in the field, typically at an unknown location.
Roving mode	Roving mode applies to the use of a rover receiver to collect data, stakeout, or control earthmoving machinery in real time using RTK techniques.
RTCM	Radio Technical Commission for Maritime Services. A commission established to define a differential data link for the real-time differential correction of roving GPS receivers. There are three versions of RTCM correction messages. All Trimble GPS receivers use Version 2 protocol for single-frequency DGPS type corrections. Carrier phase corrections are available on Version 2, or on the newer Version 3 RTCM protocol, which is available on certain Trimble dual-frequency receivers. The Version 3 RTCM protocol is more compact but is not as widely supported as Version 2.
RTK	real-time kinematic. A real-time differential GPS method that uses carrier phase measurements for greater accuracy.
SBAS	Satellite-Based Augmentation System. SBAS is based on differential GPS, but applies to wide area (WAAS/EGNOS and MSAS) networks of reference stations. Corrections and additional information are broadcast via geostationary satellites.
signal-to-noise ratio	SNR. The signal strength of a satellite is a measure of the information content of the signal, relative to the signal's noise. The typical SNR of a satellite at 30° elevation is between 47 and 50 dBHz.
skyplot	The satellite skyplot confirms reception of a differentially corrected GPS signal and displays the number of satellites tracked by the GPS receiver, as well as their relative positions.

SNR	See signal-to-noise ratio .
triple frequency GPS	A type of receiver that uses three carrier phase measurements (L1 , L2 , and L5).
UTC	Universal Time Coordinated. A time standard based on local solar mean time at the Greenwich meridian.
VRS	<p>Virtual Reference Station. A VRS system consists of GPS hardware, software, and communication links. It uses data from a network of base stations to provide corrections to each rover that are more accurate than corrections from a single base station.</p> <p>To start using VRS corrections, the rover sends its position to the VRS server. The VRS server uses the base station data to model systematic errors (such as ionospheric noise) at the rover position. It then sends RTCM correction messages back to the rover.</p>
WAAS	<p>Wide Area Augmentation System. WAAS was established by the Federal Aviation Administration (FAA) for flight and approach navigation for civil aviation. WAAS improves the accuracy and availability of the basic GPS signals over its coverage area, which includes the continental United States and outlying parts of Canada and Mexico.</p> <p>The WAAS system provides correction data for visible satellites. Corrections are computed from ground station observations and then uploaded to two geostationary satellites. This data is then broadcast on the L1 frequency, and is tracked using a channel on the GPS receiver, exactly like a GPS satellite.</p> <p>Use WAAS when other correction sources are unavailable, to obtain greater accuracy than autonomous positions. For more information on WAAS, refer to the FAA website at http://gps.faa.gov.</p> <p>The EGNOS service is the European equivalent and MSAS is the Japanese equivalent of WAAS.</p>
WGS-84	<p>World Geodetic System 1984. Since January 1987, WGS-84 has superseded WGS-72 as the datum used by GPS.</p> <p>The WGS-84 datum is based on the ellipsoid of the same name.</p>



NORTH AMERICA

Trimble Construction Division
5475 Kellenburger Road
Dayton, Ohio 45424

USA

800-538-7800 (Toll Free)
+1-937-245-5600 Phone
+1-937-233-9004 Fax

EUROPE

Trimble GmbH
Am Prime Parc 11
65479 Raunheim

GERMANY

+49-6142-2100-0 Phone
+49-6142-2100-550 Fax

ASIA - PACIFIC

Trimble Navigation Australia
PTY Limited
Level 1/120 Wickham Street
Fortitude Valley, QLD 4006

AUSTRALIA

+61-7-3216-0044 Phone
+61-7-3216-0088 Fax



www.trimble.com

Free Manuals Download Website

<http://myh66.com>

<http://usermanuals.us>

<http://www.somanuals.com>

<http://www.4manuals.cc>

<http://www.manual-lib.com>

<http://www.404manual.com>

<http://www.luxmanual.com>

<http://aubethermostatmanual.com>

Golf course search by state

<http://golfingnear.com>

Email search by domain

<http://emailbydomain.com>

Auto manuals search

<http://auto.somanuals.com>

TV manuals search

<http://tv.somanuals.com>