



Console KVM Switch with IP Access
B020-008-17-IP
User Manual

www.tripplite.com

FCC Information

This is an FCC Class A product. In a domestic environment this product may cause radio interference in which case the user may be required to take adequate measures.

This equipment has been tested and found to comply with the limits for a Class A digital device, pursuant to Part 15 of the FCC Rules. These limits are designed to provide reasonable protection against harmful interference when the equipment is operated in a commercial environment. This equipment generates, uses and can radiate radio frequency energy and, if not installed and used in accordance with the instruction manual, may cause harmful interference to radio communications. Operation of this equipment in a residential area is likely to cause harmful interference in which case the user will be required to correct the interference at his own expense.

RoHS

This product is RoHS compliant.



User Information

User Notice

All information, documentation, and specifications contained in this manual are subject to change without prior notification by the manufacturer. The manufacturer makes no representations or warranties, either expressed or implied, with respect to the contents hereof and specifically disclaims any warranties as to merchantability or fitness for any particular purpose. Any of the manufacturer's software described in this manual is sold or licensed 'as is'. Should the programs prove defective following their purchase, the buyer (and not the manufacturer, its distributor, or its dealer), assumes the entire cost of all necessary servicing, repair and any incidental or consequential damages resulting from any defect in the software.

The manufacturer of this system is not responsible for any radio and/or TV interference caused by unauthorized modifications to this device. It is the responsibility of the user to correct such interference.

The manufacturer is not responsible for any damage incurred in the operation of this system if the correct operational voltage setting was not selected prior to operation. **PLEASE VERIFY THAT THE VOLTAGE SETTING IS CORRECT BEFORE USE.**

Package Contents

The B020-008-17-IP package consists of:

- 1 B020-008-17-IP Console KVM Switch with IP Access with Standard Rack Mount Kit
- 2 Custom KVM Cable Sets
- 1 Power Cord
- 1 CD with User Manual*

Check to make sure that all of the components are present and in good order. If anything is missing, or was damaged in shipping, contact your dealer.

Read this manual thoroughly and follow the installation and operation procedures carefully to prevent any damage to the switch or to any other devices on the B020-008-17-IP installation.

* Changes may have been made to the manual since it was printed. Please visit our Website to check for the most up-to-date version.

NOTE: Follow these instructions and operating procedures to ensure correct performance and to prevent damage to this unit or to its connected devices.

Copyright © 2007 Tripp Lite. All rights reserved. All trademarks are the property of their respective owners. The policy of Tripp Lite is one of continuous improvement. Specifications are subject to change without notice.

Contents

FCC Information	2
User Information	3
User Notice	3
Package Contents	4
About This Manual	10
Overview	10
Conventions	11
Product Information	11
Chapter 1.	
Introduction	
Overview	13
Features	15
Requirements	17
External Console	17
Computers	17
Remote Computers	17
Cables	18
Converters and Adapters	18
Operating Systems	19
Components	20
Front View	20
Keyboard Module	21
LCD Module	22
Rear View	23
Chapter 2.	
Hardware Setup	
Before You Begin	25
Standard Rack Mounting	26
Single-Stage Installation	28
Two Stage Installation	30
Chapter 3.	
Basic Operation	
Opening the Console	31
Opening Separately	31
Opening Together	33
Operating Precautions	34
Closing the Console	35
LCD OSD Configuration	37
The LCD Buttons	37
The Adjustment Settings	38
Port Selection	39

Manual Port Switching	39
Hot Plugging	39
Powering Off and Restarting.	39
Port ID Numbering	39

Chapter 4.

Administration

Overview	41
The Local Console	41
The Main Page	42
Quick View Ports.	43
The List Function.	44
Port Names	46
Port Operation	48
The Configuration Page	49
The Administration Page	51
General	51
User Management.	52
Service Configuration	55
Network	56
ANMS	58
Security	61
Customization	63
Date/Time	67
The Log Page	68
Upgrading the Firmware	69

Chapter 5.

Browser Operation

Overview	71
Logging In.	71
Webpage Layout.	73
Webpage Icons	73
The General Dialog Box	74
Webpage Buttons	75

Chapter 6.

Windows Client Port Operation

Activating the OSD	77
The Windows Client OSD.	80
Windows Client Control Panel	81
Hotkey Setup.	82
Video Adjustment	84
The Message Board	87
The Main Page	90
Port Operation	91

The OSD Toolbar	91
Recalling the OSD	91
OSD Hotkey Summary Table	92
OSD Toolbar Icons	92
Multiuser Operation	93
Keyboard Hotkey Operation	94
Auto Scanning	94
Setting the Scan Interval	94
Invoking Auto Scan	94
Pausing Auto Scan	95
Exiting Auto Scan	95
Skip Mode	95
Keyboard and Mouse Considerations	96
Keystrokes	96
Mouse Synchronization	97

Chapter 7.

Java Client Port Operation

Activating the OSD	99
The Java Client OSD	100
The Java Client Control Panel	101
Set Video Parameters	101
Keypad	102
Mouse Synchronization	102
Message Board	103
Lock Key LEDs and Resolution	106
Switch Screen Mode	106
About	106
Send Ctrl+Alt+Del	106
Help	106
Exit	106
Port Operation	107
Keyboard Hotkey Operation	107

Chapter 8.

The Log File

The Main Screen	109
---------------------------	-----

Chapter 9.

The Log Server

Installation	111
Starting Up	112
The Menu Bar	113
Configure	113
Events	114
Options	116

Help	116
The Log Server Main Screen	117
Overview	117
The List Panel	118
The Tick Panel	118

Chapter 10.

AP Operation

Overview	119
The Windows Client	119
Installation	119
Starting Up	120
The File Menu	122
The Tools Menu	122
Connecting	124
Operation	125
Ending the Session	125
The Java Client	126
Installation	126
Starting Up	126
Operation	128

Appendix

Safety Instructions	129
General	129
Rack Mounting	131
Specifications	132
OSD Factory Default Settings	133
Trusted Certificates	134
Overview	134
Installing the Certificate	135
Certificate Trusted	136
Troubleshooting	137
Administration	137
General Operation	138
The Java Client	140
The Log Server	140
Panel Array Mode	141
The Windows Client	141
Sun Systems	142
Screen Resolutions Higher than 1280 x 1024	143
Additional Mouse Synchronization Procedures	145
Administrator Login Failure	147
Dedicated Invocation Keys	148
About SPHD Connectors	149
Supported KVM Switches	149

Limited Warranty 150

About This Manual

This User Manual is provided to help you get the most from your B020-008-17-IP system. It covers all aspects of installation, configuration and operation. An overview of the information found in the manual is provided below.

Overview

Chapter 1, Introduction, introduces you to the B020-008-17-IP System. Its purpose, features and benefits are presented, and its front and back panel components are described.

Chapter 2, Hardware Setup, provides step-by-step instructions for setting up your installation, and explains some basic operating procedures.

Chapter 3, Basic Operation, explains the fundamental concepts involved in operating the B020-008-17-IP.

Chapter 4, Administration, explains the administrative procedures that are employed to configure the B020-008-17-IP's working environment, as well as how to operate the B020-008-17-IP from the local console.

Chapter 5, Browser Operation, describes how to log into the B020-008-17-IP with your browser, and explains the functions of the icons and buttons on the B020-008-17-IP webpage.

Chapter 6, Windows Client Port Operation, explains how to use the Windows Client to access and control the computers connected to the switch.

Chapter 7, Java Client Port Operation, describes how to use the Java Client to access and control the computers connected to the switch.

Chapter 8, The Log File, shows how to use the log file utility to view all the events that take place on the B020-008-17-IP.

Chapter 9, The Log Server, explains how to install and configure the Log Server.

Chapter 10, AP Operation, describes how to operate the B020-008-17-IP using Windows and Java Client application programs, rather than with the browser method.

An Appendix at the end of the manual provides technical and troubleshooting information.

Conventions

This manual uses the following conventions:

Monospaced	Indicates text that you should key in.
[]	Indicates keys you should press. For example, [Enter] means to press the Enter key. If keys need to be chorded, they appear together in the same bracket with a plus sign between them: [Ctrl+Alt].
1.	Numbered lists represent procedures with sequential steps.
◆	Bullet lists provide information, but do not involve sequential steps.
→	Indicates selecting the option (on a menu or dialog box, for example), that comes next. For example, Start → Run means to open the <i>Start</i> menu, and then select <i>Run</i> .
	Indicates critical information.

Product Information

For information about all Tripp Lite products and how they can help you connect without limits, visit Tripp Lite on the Web or contact an Tripp Lite Authorized Reseller. Visit Tripp Lite on the Web for a list of locations and telephone numbers

- ◆ International – <http://www.tripplite.com>

This Page Intentionally Left Blank

Chapter 1

Introduction

Overview

The B020-008-17-IP Console KVM Switch with IP Access is a control unit that allows secure access to multiple computers from a single KVM (keyboard, video, and mouse) console. A single B020-008-17-IP can control up to 8 computers. It consists of an integrated LCD monitor, keyboard, and touchpad in a 1U rack-mountable retractable sliding housing.

The LCD and keyboard/touchpad modules slide independently of each other. To maximize space in your data center, the keyboard/touchpad module slides back to "hide away" when not in use, while the thin profile LCD monitor rotates back – flush against the rack – allowing convenient monitoring of computer activity.

The B020-008-17-IP features IP-based connectivity that allows one local operator and multiple remote operators to concurrently monitor and access the computers on your installation. Because the it uses TCP/IP for its communications protocol, the B020-008-17-IP can be accessed from any computer on the LAN, WAN, or Internet – whether that computer is located down the hall, down the street, or halfway around the world.

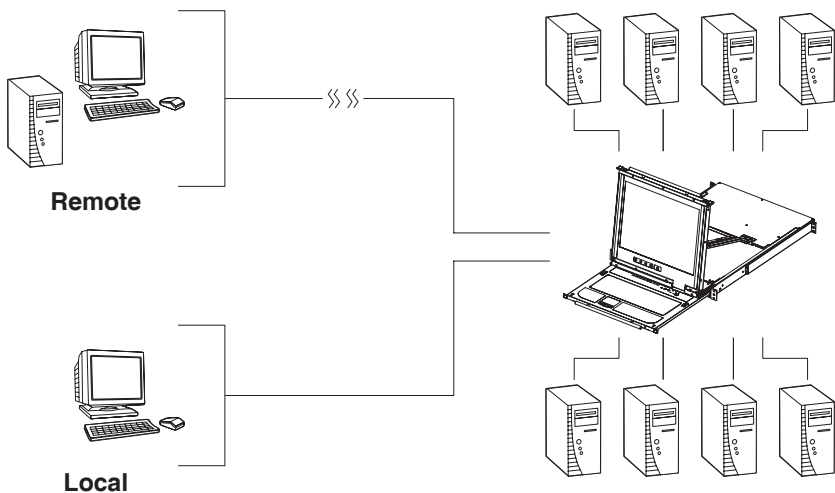

For added convenience, ports for an external keyboard, monitor, and mouse are provided on the rear panel – permitting you to manage the switch from a local console up to 20 meters away. There is also an external PS/2 mouse port on the keyboard module, allowing you to use an external mouse, rather than the touchpad.

Access to any computer connected to the installation from the local console is easily accomplished by means of a powerful mouse driven graphical OSD (On Screen Display) menu system. A convenient *Auto Scan* feature also permits automatic scanning and monitoring of the activities of all computers running on the installation one by one.

Remote operators connect to the B020-008-17-IP via its IP address from anywhere on the LAN, WAN, or Internet via their browsers. Once they successfully log in, they can take control using either the *Windows Client* or *Java Client* utility. Inclusion of a Java-based client ensures that the B020-008-17-IP is platform independent, and is able to work with most operating systems.

System administrators can handle a multitude of maintenance tasks smoothly and efficiently – from installing and running GUI applications, to BIOS level troubleshooting, routine monitoring, concurrent maintenance, system administration, rebooting and even pre-booting functions – all from a remote connection.

Remote operators can exchange keyboard, video and mouse signals with the computers attached to the B020-008-17-IP just as if they were present locally and working on the equipment directly.

Enhanced features include a *Panel Array Mode* that displays the video output of up to 8 computers at the same time, and a *Message Board* that allows logged in users to conveniently and instantly communicate with one other – no matter where in the world they actually are.

The B020-008-17-IP utilizes high density 15-pin KVM port connectors instead of the usual 25-pin connectors. This space-saving innovation allows a full 8 port switch to be conveniently installed in one unit of system rack space.

Setup is fast and easy - plugging cables into their appropriate ports is all that is entailed. Because the B020-008-17-IP intercepts keyboard input directly, there is no need to get involved in complex installation routines or to be concerned with incompatibility problems.

Since the B020-008-17-IP's firmware is upgradable over the Internet, you can stay current with the latest functionality improvements simply by downloading firmware updates from our website as they become available.

With its advanced security features, the B020-008-17-IP is the fastest, most reliable, most cost effective way to remotely access and manage widely distributed multiple computer installations.

Features

- ◆ 8 port remote access KVM switch in a sliding dual rail housing with top and bottom clearance for smooth operation in a 1U high rack
- ◆ Integrated KVM console with 17" LCD monitor, keyboard, and touchpad
- ◆ Dual slide – LCD Monitor module can slide independently of the keyboard/touchpad module
- ◆ Dual bus support – one local and one remote user can simultaneously control up to 8 computers
- ◆ A single console controls up to 8 computers – cascade additional units to control up to 64 computers
- ◆ Remotely access computers via the LAN, WAN, or Internet – control your installation when and where you want
- ◆ Grayscale option to improve transfer speed in low bandwidth situations
- ◆ User-selectable network transfer rate
- ◆ External console ports – manage computers in the LCD KVM switch from an external console (PS/2 keyboard, monitor, and PS/2 mouse)
- ◆ Supports external PS/2 mouse
- ◆ Supports dedicated OSD and OSD Toolbar invocation keys
- ◆ Console lock – enables the console modules to remain securely locked away in position when not in use
- ◆ Internet browser access – Windows Client and Java Client provided, Java Client works with most operating systems*
- ◆ Graphical OSD and graphical toolbars for convenient, user-friendly operation
- ◆ Up to 64 user accounts – up to 32 concurrent remote logins
- ◆ Panel Array Mode – view all 8 ports at the same time
- ◆ Message board feature allows logged in users to communicate with each other and allows a remote user to take exclusive control of the KVM functions
- ◆ Windows-based Log Server

- ◆ Three user account types: Administrator, User, and Select
- ◆ Advanced security features include password protection and advanced encryption technologies: 1024-bit RSA, 256-bit AES, 56-bit DES, and 128-bit SSL
- ◆ Supports RADIUS server authentication
- ◆ Supports CC1000 management
- ◆ Flash firmware upgradable over a network connection
- ◆ Ports can be set to Exclusive, Occupy and Share
- ◆ Network Interfaces: TCP/IP, HTTP, HTTPS, UDP, RADIUS, DHCP, SSL, ARP, DNS, 10Base-T/100Base-TX, Auto Sense, and Ping
- ◆ High video resolution: up to 1280 x 1024 @ 75Hz (17" LCD monitor); 1600 x 1200 @ 60Hz (remote computer)

* Browsers must support 128-bit SSL encryption.

Requirements

External Console

- ◆ A VGA, SVGA, or MultiSync monitor capable of displaying the highest resolution provided by any computer in the installation
- ◆ PS/2 keyboard and mouse

Computers

The following equipment must be installed on each computer:

- ◆ A VGA, SVGA or MultiSync video graphics card with an HDB-15 port

Note: The integrated LCD monitor's maximum screen resolution is 1280 x 1024 @ 75 Hz. If you want to use a higher setting for the screen resolutions of the attached computers, see *Screen Resolutions Higher than 1280 x 1024*, page 143.

- ◆ PS/2 mouse and keyboard ports (6-pin Mini-DIN)

Remote Computers

- ◆ For best results, computers that remotely access the B020-008-17-IP should have at least a P III 1 GHz processor, with their screen resolution set to 1024 x 768.
- ◆ Users who want to access the B020-008-17-IP with the Windows Client must have DirectX 7.0 or higher installed.

If you don't already have it, DirectX is available for free download from Microsoft's Website: <http://www.microsoft.com/downloads>.

- ◆ Users who want to access the B020-008-17-IP with the Java Client must have Sun's Java 2 (1.4.2 or higher) runtime environment installed. Java is available for free download from the Sun Java Website: <http://java.sun.com>.
- ◆ Browsers must support 128-bit SSL encryption.
- ◆ For best results, a network transfer speed of at least 128 Kbps is recommended.

Cables

Substandard cables may degrade system performance or damage your installation. For optimum signal integrity and reliability, we strongly recommend that you use Tripp Lite's high-quality, custom cable sets. To purchase cable sets contact your dealer. Lengths and part numbers are provided in the following table:

Item	Length	Part Number
KVM Switch PS/2 Cable Kit	6'	P774-006
KVM Switch PS/2 Cable Kit	10'	P774-010
KVM Switch PS/2 Cable Kit	15'	P774-015
KVM Switch PS/2 Cable Kit	25'	P774-025
KVM Switch USB Cable Kit	6'	P776-006
KVM Switch USB Cable Kit	10'	P776-010
KVM Switch USB Cable Kit	15'	P776-015

Converters and Adapters

Adapters and converters are used to connect Mac or Sun computers to the B020-008-17-IP. To purchase adapters and converters contact your dealer.

Operating Systems

Supported operating systems are shown in the table, below:

OS	Version	
Windows		2000 and higher
Linux	RedHat	6.0 and higher
	SuSE	8.2 and higher
	Mandriva (Mandrake)	9.0 and higher
UNIX	AIX	4.3 and higher
	FreeBSD	3.51 and higher
	Sun	Solaris 8 and higher
Novell	Netware	5.0 and higher
Mac		8.6 and higher
OS/2		Warp and higher
DOS		6.2 and higher

Components

Front View

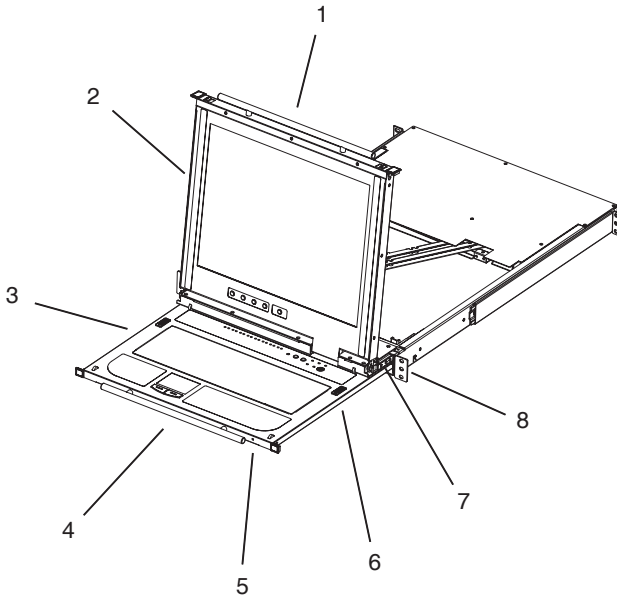

No.	Component	Description
1	Upper Handle	Pull to slide the LCD module out; push to slide the module in. See <i>Opening the Console</i> , page 31, for details on sliding the console in and out.
2	LCD Module	See <i>LCD Module</i> , page 22.
3	Keyboard Module	See <i>Keyboard Module</i> , page 21.
4	Lower Handle	Pull to slide the keyboard module out. See <i>Opening the Console</i> , page 31, for more details on sliding the console in and out.
5	Power LED	Lights (blue) to indicate that the unit is receiving power.
6	Keyboard Release Catch	These catches (one on each side) release the keyboard module so you can slide it away.
7	LCD Release Catch	These catches (one on each side) release the LCD module so you can slide it away.
8	Rack Mounting Tabs	The rack mounting tabs located at each corner of the unit secure the chassis to a system rack. See <i>Standard Rack Mounting</i> , page 26, for details.

Keyboard Module

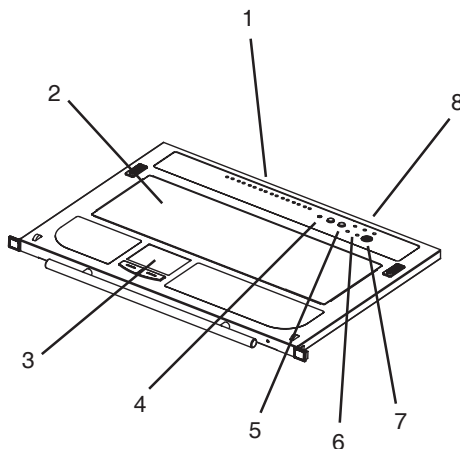

No.	Component	Description
1	Port LEDs	<ul style="list-style-type: none"> ◆ An <i>On Line</i> LED lights to indicate that the device attached to its corresponding port is up and running. ◆ A Selected LED lights to indicate that the computer attached to its corresponding port has the KVM focus.
2	Keyboard	Standard 105-key keyboard
3	Touchpad	Standard mouse touchpad
4	Reset Switch	<ul style="list-style-type: none"> ◆ Pressing and holding this switch in while powering on the unit causes the B020-008-17-IP to revert to the original factory installed firmware version – allowing you to recover from a failed firmware upgrade. ◆ Pressing and holding this switch in for more than three seconds performs a system reset. <p>Note: The switch is recessed and must be pushed with a thin object - such as the end of a paper clip or a ballpoint pen.</p>
5	Port Selection Switches	<ul style="list-style-type: none"> ◆ The left button (DOWN), shifts the KVM focus down through the ports (Port 7 → Port 6, etc.). After Port 1, it cycles back to the last port. ◆ The right button (UP), shifts the KVM focus up through the ports. After the last port, it cycles to Port 1.

(Continues on next page.)

(Continued from previous page.)

No.	Component	Description
6	Connection LEDs	<ul style="list-style-type: none"> ◆ The <i>LINK</i> LED flashes when a remote client connects to the KVM switch. ◆ The <i>10/100 Mbps</i> LED lights orange to indicate 10 Mbps data transmission speed. It lights green for 100 Mbps.
7	External Mouse Port	This PS/2-type mouse port is provided for users who prefer to use an external mouse.
8	Lock LEDs	The Num Lock, Caps Lock, Scroll Lock LEDs are located here.

LCD Module

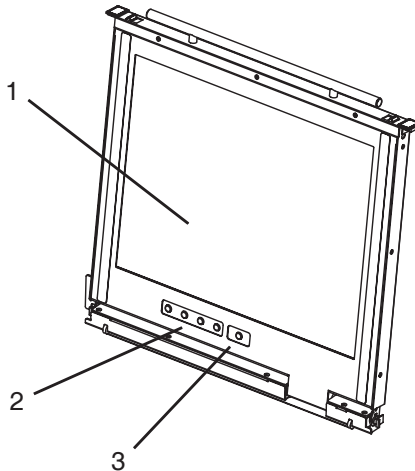

No.	Component	Description
1	LCD Display	To access the LCD monitor, slide the LCD module out and flip up the cover. See <i>Opening the Console</i> , page 31, for details on sliding the LCD module out.
2	LCD Controls	These buttons control the position and picture settings of the LCD display. See <i>LCD OSD Configuration</i> , page 37, for details.
3	LCD On/Off Button	Push this button to turn the LCD monitor on and off. The button lights when the LCD monitor is off to indicate that only the monitor is off – not the KVM switch itself.)

Rear View

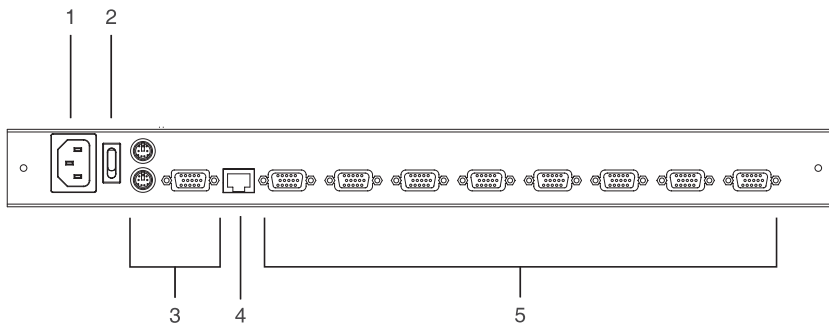

No.	Component	Description
1	Power Socket	This is a standard 3-pin AC power socket. The power cord from an AC source plugs in here.
2	Power Switch	This is a standard rocker switch that powers the unit on and off.
3	External Console Ports	For flexibility and convenience, the B020-008-17-IP supports an external KVM console. A custom console cable set is provided to attach the external console's monitor, keyboard, and mouse.
4	LAN Port	The cable that connects the B020-008-17-IP to a LAN, WAN, or Internet plugs in here.
5	KVM Ports	The cables that link to the computers plug in here. Note: The shape of these 15-pin connectors has been specifically modified so that only custom KVM cables designed to work with this switch can plug in. (See <i>Cables</i> , page 18, for details.) Do NOT attempt to use ordinary 15-pin VGA connector cables to link these ports to the computers.

This Page Intentionally Left Blank

Chapter 2

Hardware Setup

Before You Begin



1. Important safety information regarding the placement of this device is provided on page 129. Please review it before proceeding.
2. Make sure that power to all the devices you will be connecting up has been turned off. You must unplug the power cords of any computers that have the Keyboard Power On function.
3. Packing material has been inserted to protect the B020-008-17-IP during shipping. Slide the LCD module out (See *Opening the Console*, page 31), until the packing material is visible. Remove the packing material before installing the unit, as shown in the diagram below.

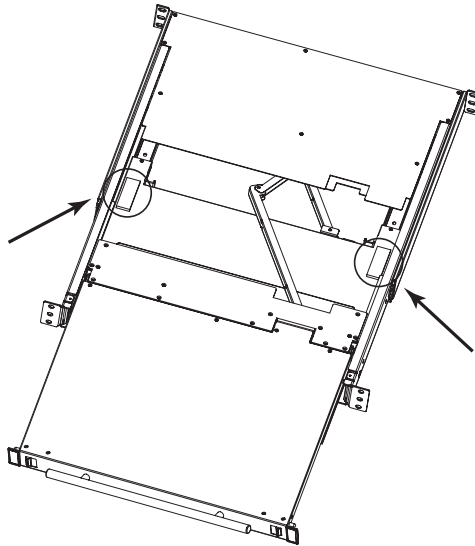

Standard Rack Mounting

A standard rack mounting kit is provided with your B020-008-17-IP. The kit enables the switch to be mounted in a rack with a depth of 17”–30”.

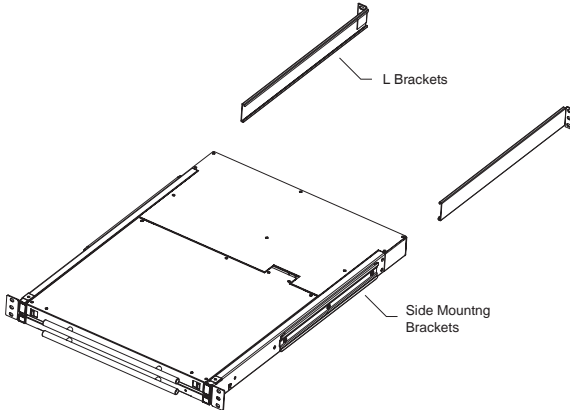

Note: It takes two people to mount the switch: one to hold it in place, the other to screw it in. Optional mounting kits – including single person *Easy Installation* kits – are available with a separate purchase. See *Dedicated Invocation Keys*, page 148, for details.

To rack mount the switch, do the following:

1. While one person positions the switch in the rack and holds it in place, the second person – using the screws provided with the rack mounting kit – loosely screws the front brackets to the rack.

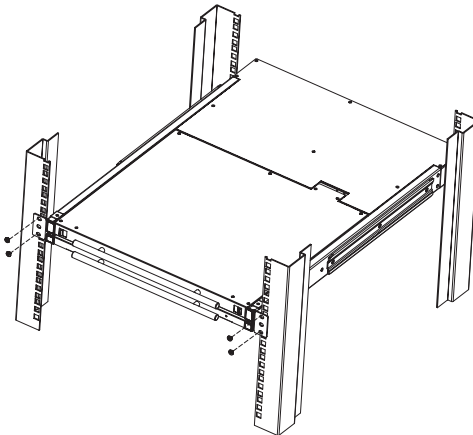

2. While the first person still holds the switch in place, the second person slides the L brackets into the switch's side mounting brackets, from the rear until the bracket flanges contact the rack, then – using the screws provided with the rack mounting kit – screws the L brackets to the rack.

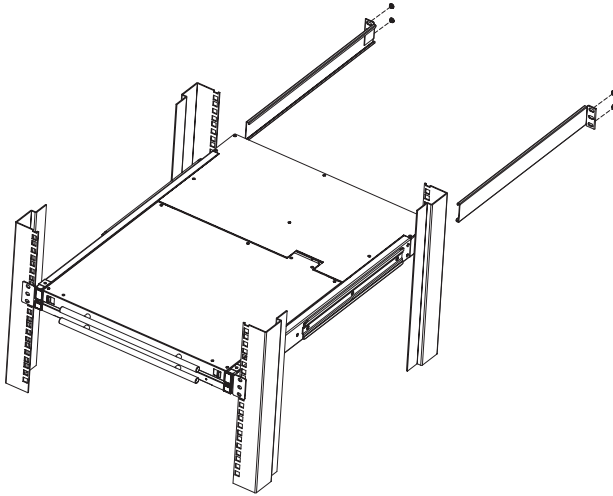

3. After the L brackets have been secured, tighten the front bracket screws.

Note: 1. Cage nuts are provided for racks that are not prethreaded.

2. Allow at least 2" on each side for proper ventilation, and at least 5" at the back for the power cord and cable clearance.
-

Single-Stage Installation

In a Single Stage installation, there are no additional switches daisy chained down from the first unit. To set up a single stage installation, refer to the installation diagram on the following page (the numbers in the diagram correspond to the numbers of the installation steps) and do the following:

1. (*Optional*) If you choose to install an external console, plug your keyboard, monitor, and mouse into the *Console Ports* located on the B020-008-17-IP's rear panel. The ports are color coded and marked with an icon to identify themselves.
2. Using a KVM cable set (see *Cables*, page 18), plug the custom SPHD (yellow) connector into any available KVM port on the switch.
3. At the other end of the cable, plug the keyboard, video (blue), and mouse connectors into their respective ports on the computer.
4. Plug the cable from the LAN into the LAN port on the B020-008-17-IP's rear panel.
5. Connect the power cord provided with this package to an AC source and the B020-008-17-IP's power socket.

Repeat steps 2 – 5 for any other computers you wish to install.

After you are all cabled up, you can power on the switch. After the switch is powered on, power on the computers.

Single-Stage Installation Diagram

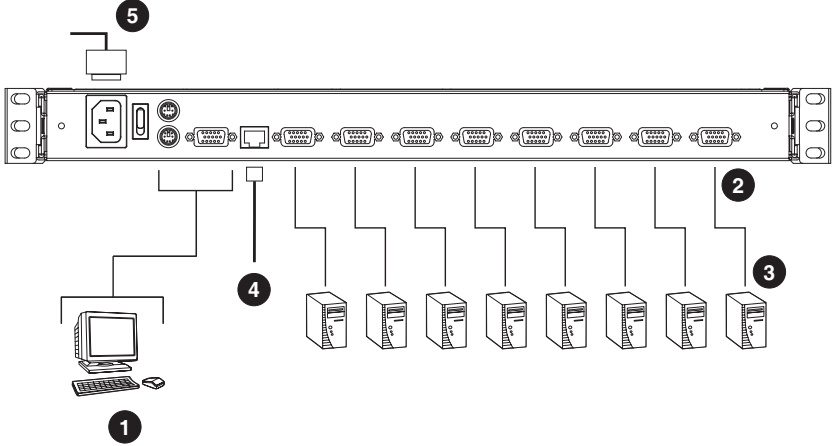

Two Stage Installation

To expand the number of computers that can be controlled in your KVM installation, up to 8 additional KVM switches (model B007-008) can be cascaded from the B020-008-17-IP's KVM ports. As many as 64 computers can be controlled in a complete two stage installation.

In a two stage installation, the B020-008-17-IP is considered the *first stage* unit; the cascaded switches are considered *second stage* units.

To set up a two stage installation, do the following:

1. Make sure that power to all the devices you will be connecting up, including all preexisting devices on the installation, have been turned off.
2. Use a KVM cable set (see *Cables*, page 18), to connect any available KVM Port on the First Stage unit to the Console ports of the Second Stage unit.
3. Use KVM cable sets (as described in the *Cables* section of the user manual for the cascaded KVM switch) to connect any available KVM port on the cascaded KVM switch to the keyboard, video, and mouse ports of the computers you are installing.
4. Plug the power cord that came with the cascaded KVM switch into its power socket, and then into an AC power source.
(Repeat Steps 2–4 for any additional KVM switches that you wish to cascade from the B020-008-17-IP.)
5. Power on the B020-008-17-IP.
6. Power on the cascaded KVM switches.
7. Power on the computers.

Chapter 3

Basic Operation

Opening the Console

The B020-008-17-IP's console consists of two modules: an LCD display module located under the top cover; and a keyboard/touchpad module below the LCD module.

The modules can either slide together, or independently. This allows you to have the LCD display available for viewing while the keyboard/touchpad module is conveniently out of the way when not in use.

Opening Separately

1. Pull the release catches to release the console, and pull the top panel a few centimeters toward you. Once the console has been released, you can let go of the catches.

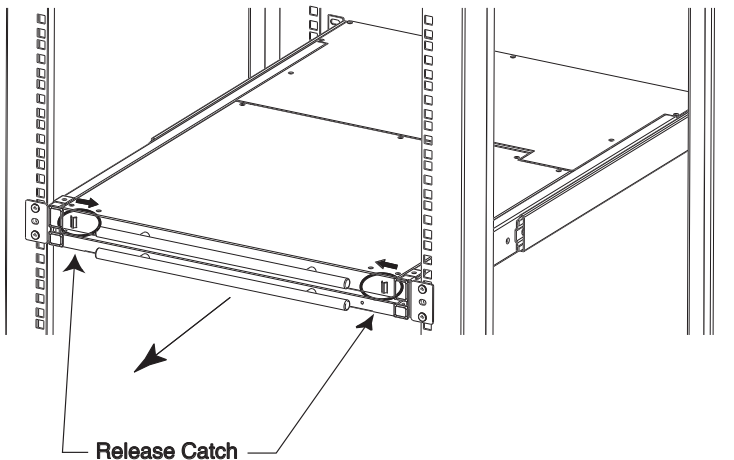

(Continues on next page.)

(Continued from previous page.)

2. Pull the top panel all the way out until it clicks into place.

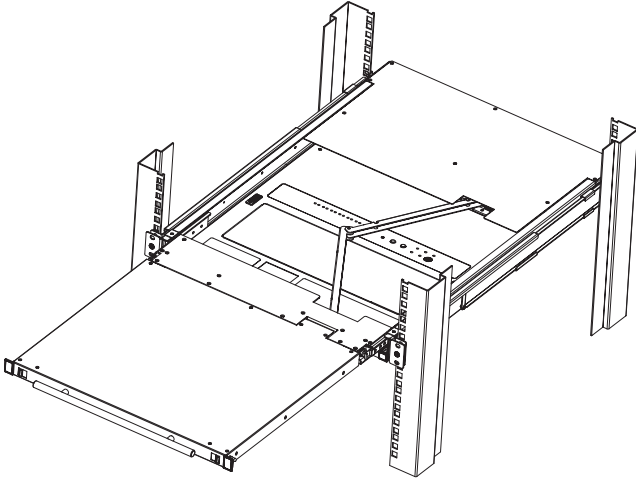

3. Rotate the top panel all the way back to expose the LCD screen.

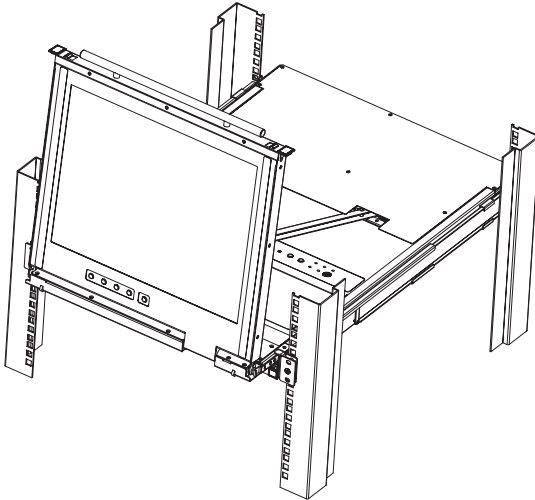

4. Reach underneath and pull the keyboard module all the way out until it clicks into place.

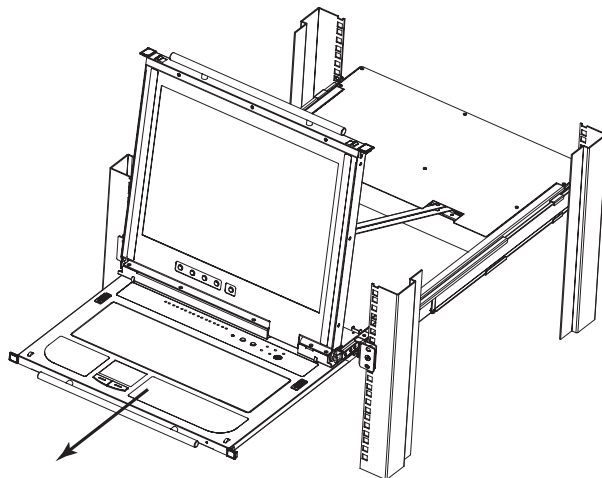

Opening Together

Refer to the diagrams in the *Opening Separately* section as you do the following:

1. Pull the release catches and pull the top and bottom panels out until the keyboard module clicks into place.

Note: Once the console has been released, you can let go of the catches.

2. Pull the top panel the rest of the way out until it clicks into place.
3. Rotate the top panel all the way back to expose the LCD screen.

Note: Refer to the warning regarding placing excessive weight on the keyboard module on the following page.

Operating Precautions

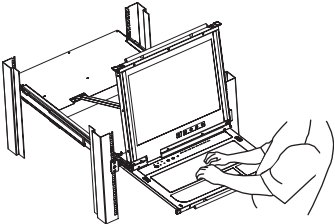
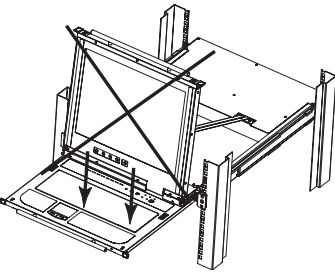

The maximum load bearing capacity of the keyboard module is 65lbs. Failure to heed the information below can result in damage to the keyboard module.

	<p>RIGHT</p> <p>Rest your hands and arms lightly on the keyboard module as you work.</p>
	<p>WRONG!</p> <ul style="list-style-type: none">◆ DO NOT lean your body weight on the keyboard module.◆ DO NOT place heavy objects on the keyboard module.

Closing the Console

1. Pull the release catches located on either side of the keyboard toward you to release the keyboard module, then slide the module slightly in.

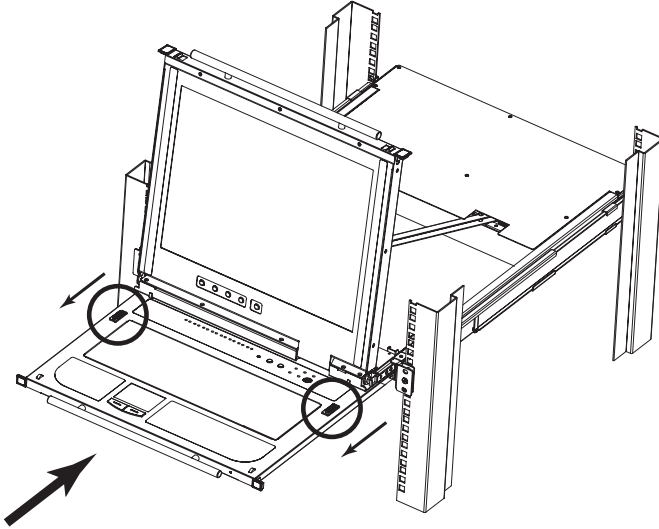

2. Let go of the catches. Using the front handle, push the keyboard module all the way in.

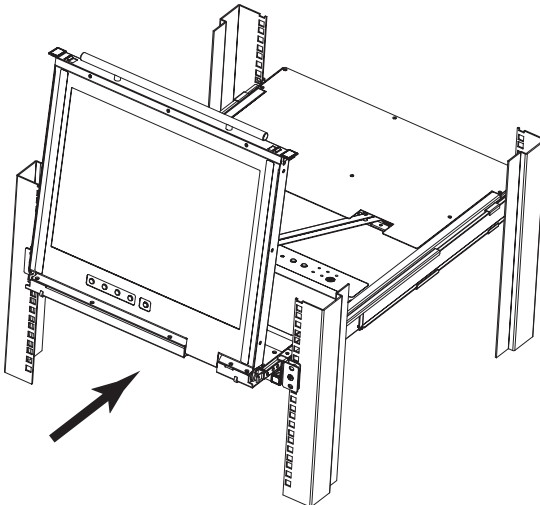

3. Rotate the LCD module all the way down, then pull the rear catches to release the LCD module.

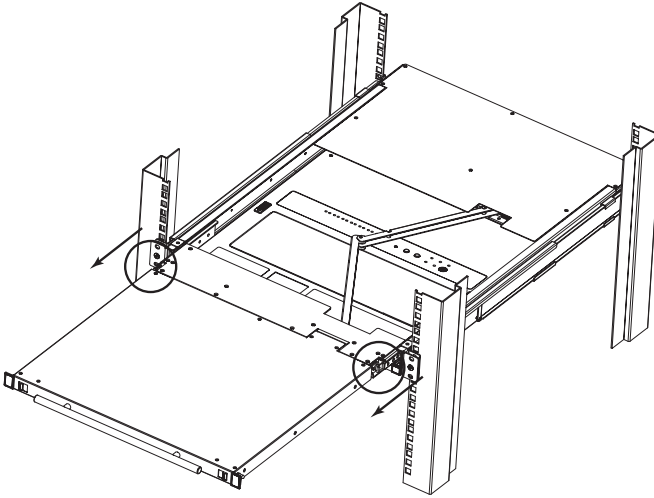

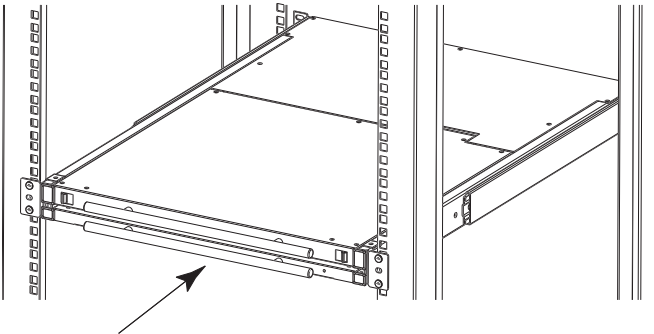

4. Using the front handle, push the module all the way in.



LCD OSD Configuration

The LCD Buttons

The LCD OSD allows you to set up and configure the LCD display. Four buttons (see *LCD Controls*, page 22), are used to perform the configuration, as described in the table below:

Button	Function
MENU	When you have not entered the LCD OSD Menu function, pressing this button invokes the Menu function and brings up the Main Menu.
	When navigating through the menus, this button moves you right or up. When making an adjustment, it increases the value.
	When navigating through the menus, this button moves you left or down. When making an adjustment, it decreases the value.
EXIT	<ul style="list-style-type: none"> ◆ When you have not entered the LCD OSD Menu function, pressing this button performs an auto adjustment. An auto adjustment automatically configures all the settings for the LCD panel to what the OSD considers their optimum values to be. ◆ When you have entered the LCD OSD Menu function, pressing this button exits the current menu and returns you to the previous menu. Use it to leave an adjustment menu when you are satisfied with the adjustment you have made. ◆ When you are at the Main Menu, pressing this button exits the LCD OSD.

The Adjustment Settings

An explanation of the LCD OSD adjustment settings is given in the table below:

Setting	Explanation
Brightness	Adjusts the background black level of the screen image.
Contrast	Adjusts the foreground white level of the screen image.
Phase	Adjusts the vertical size of the screen image.
Clock	Adjusts the horizontal size of the screen image.
H-Position	Positions the display area on the LCD panel horizontally (moves the display area left or right).
V-Position	Positions the display area on the LCD panel vertically (moves the display area up or down).
Color Temperature	Adjusts the color quality of the display. You can adjust the "warmth" value, color balance, etc. The <i>Adjust Color</i> selection has a further submenu that lets you fine tune the RGB values.
Language	Selects the language that the OSD displays its menus in.
OSD Duration	Lets you set the amount of time that the OSD displays on the screen. If there is no input for the amount of time you choose, the OSD display turns off.
Reset	Resets the menu and submenu adjustments (except for language settings) to the original factory default settings.

Port Selection

The B020-008-17-IP provides three port selection methods to access the computers on the installation: Manual, an OSD (On Screen Display) menu system, and Hotkeys. OSD Operation and Hotkey Port Selection are discussed in *Windows Client Port Operation* and *Java Client Port Operation* Chapters.

Manual Port Switching

Use the *Port Selection Switches* on the keyboard to manually switch to a port.

Hot Plugging

The B020-008-17-IP supports *hot plugging* - components can be removed and added back into the installation by unplugging and replugging their cables from the ports without the need to shut the unit down.

If you change computer positions, in order for the OSD menus to correspond to the KVM port changes, you must manually edit the Port Names for the OSD to reflect the new port information. See *Port Names* (page 46) for details.

Note: If the computer's operating system does not support hot plugging, this function may not work properly.

Powering Off and Restarting

If it becomes necessary to power off the B020-008-17-IP, or if the switch loses power and needs to be restarted, wait 10 seconds before powering it back on. The computers should not be affected by this, but if any of them should fail, simply restart the affected computers.

Port ID Numbering

Each of the B020-008-17-IP's KVM ports is assigned a two-digit Port ID number. You can access any device by specifying the Port ID of the port that it is connected to. Port numbers from 1 - 8 are padded with a preceding zero, so they become 01 - 08.

For example, a computer attached to **Port 6** would have a Port ID of: **06**.

This Page Intentionally Left Blank

Chapter 4 Administration

Overview

The OSD's *Administration* page lets the Administrator (and users with administration permission - see *User Management*, page 52) configure and control the overall operations of the B020-008-17-IP. The *Administration* tab is disabled (grayed out) for users who do not have administration permission.

The Local Console

Once the B020-008-17-IP has been installed, the next step that the Administrator needs to perform is to set up the unit for user operation. The most convenient way to do this for the first time is from the local console.

After turning on the B020-008-17-IP, a login prompt appears:

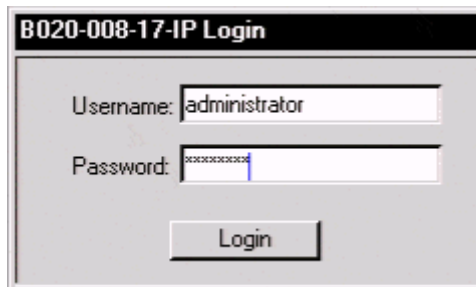

The image shows a login dialog box titled "B020-008-17-IP Login". It has two input fields: "Username:" containing the text "administrator" and "Password:" containing masked characters "xxxxxxxx". Below the fields is a "Login" button.

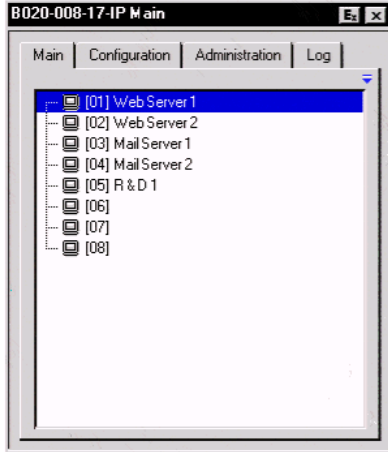

Since this is the first time you are logging in, use the default Username: *administrator*; and the default Password: *password*. For security purposes, we strongly recommend that you use the User Management function (see page 52) to remove these and give yourself a unique Username and Password with the appropriate permissions.

After you successfully log in, the Local Console OSD appears:



The OSD consists of four pages, each with a specific set of functions: Main, Configuration, Administration, and Log. Each of page is discussed in the sections that follow.

The functions of the two buttons at the right of the title bar are described in the table below. Functions can be invoked by clicking the icon, or by pressing its associated function key.

Button	Key	Function
	Esc	Close: Closes the OSD display but does not log you out of the session. You can bring the display back with the OSD hotkeys (see <i>OSD Hotkey</i> , page 50).
	F8	Log Out: Closes the OSD display and logs you out of the session.

The Main Page

The Main page governs port access. Selecting a port and double-clicking it switches you to the device on that port.

- ◆ A *monitor* icon is in front of the port number. The monitor icon is green for ports that have devices connected to them that are powered on; otherwise, it is gray.

- ♦ If a port has been specified as a Quick View port (see below), a red *eye* icon is displayed along with the monitor icon to indicate so.

In addition to using this page to select ports to switch to, the administrator can also use this page to enable/disable *Quick View* status for selected ports, and to create, modify, or delete names for each of the ports. The following sections describe how to enable Quick View status and how to create, modify, or delete port names.

Quick View Ports

Selecting certain ports as Quick View ports is a way of limiting which ports are included when the B020-008-17-IP is in Auto Scan mode. If the B020-008-17-IP is configured to only auto scan ports that have Quick View status (see *Scan Select*, page 50), designating a port as a Quick View port in this dialog box means that it will be included when auto scanning is in effect.

The spacebar toggles a port's Quick View status. To select/deselect a port, highlight it and press the **spacebar**. When a port has been selected as a Quick View port, a red *eye* icon displays in the port icon column to indicate so. When a port isn't selected, there is no red eye icon.

The List Function

The List Function lets you broaden or narrow the scope of which ports the OSD displays (lists) in the Main Screen. To invoke the List Function, click the arrow at the upper right corner of the screen, or press [F3]:

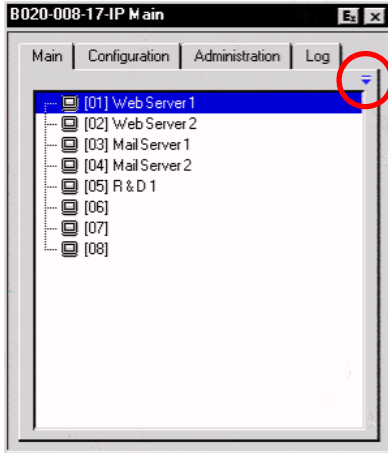

The screen changes to allow you to choose the ports that will be listed:

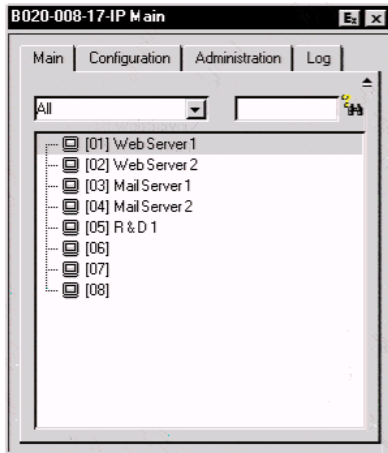

The drop down list on the left offers four fixed choices as shown in the table, below:

Choice	Meaning
All	Lists all of the ports on the installation.
Powered On	Lists only the ports that have their attached devices powered on.
Quick View	Lists only the ports that have been selected as Quick View ports (see <i>Quick View Ports</i> , page 43).
Quick View + Powered On	Lists only the ports that have been selected as Quick View Ports (see <i>Quick View Ports</i> , page 43), and that have their attached devices Powered On.

The text input box on the right allows you to key in a port name so that only port names that match what you key in show up in the list. Wildcards (? and *) are acceptable, so that more than one port can show up in the list. For example, if you key in **Web***, both Web Server 1 and Web Server 2 would show up in the list, as shown below:

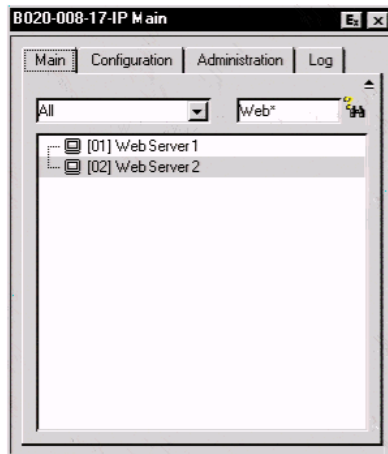

- ◆ After you key in your string, either click the binoculars to the right of the box, or press **[Enter]**.
- ◆ To go back to the default view, erase the string and either click the binoculars to the right of the box, or press **[Enter]**.
- ◆ To dismiss the List function, click the arrow or press **[F3]**.

Port Names

To help remember which computer is attached to a particular port, every port can be given a name. This field allows the Administrator to create, modify, or delete port names. To configure a port name:

1. Click once on the port you want to edit, wait one second and then click it again. (Alternately, use the up and down arrow keys to move the highlight bar to the port, and then press the F2 function key.)

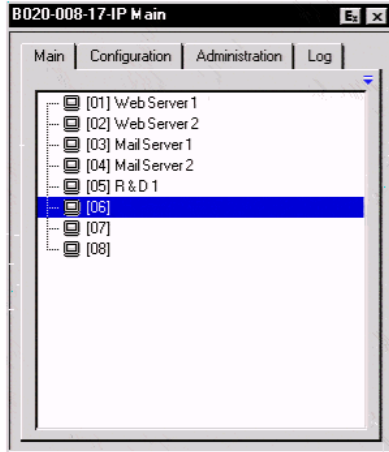

Note: This is not a double-click. It involves two separate clicks. A double-click will switch you to the device attached to the port.

After a second or two, the bar changes to provide you with a text input box:

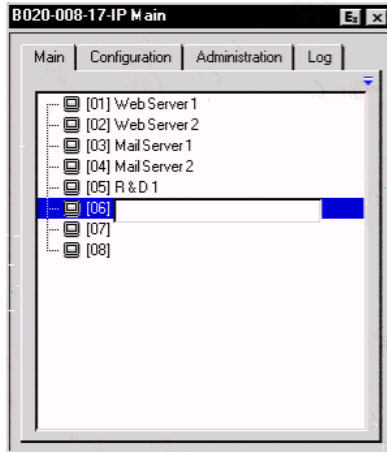

2. Key in the new Port Name, or modify/delete the old one.

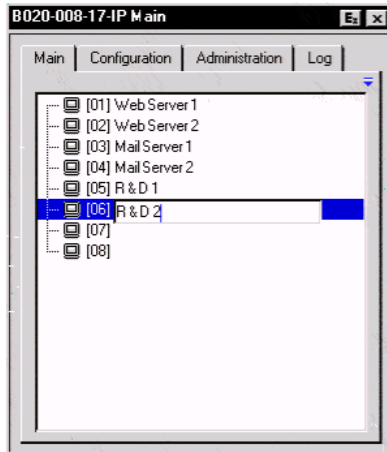

The maximum number of characters allowed for a Port Name is 19. You can use all letters, numbers, and symbols on the typewriter keys of keyboards with PC US English layout.

3. When you have finished editing the port name, press [Enter] or click anywhere outside of the input box to complete the operation.

Port Operation

Because the methods used to access the target device(s) are the same for the local console as for the Windows Client, the procedures are discussed in *Windows Client Port Operation* and *Java Client Port Operation* Chapters on pages 91 and 107, respectively.

Note: If you invoke the OSD while accessing a target device from the local console, press [F6] to hide the background and enlarge the OSD. Press [F6] again to show the background.

The Configuration Page

The OSD *Configuration* page allows users to set up their own, individual, working environments. The B020-008-17-IP stores a separate configuration record for each user profile, and sets up the working configuration according to the *Username* that is used to log in.

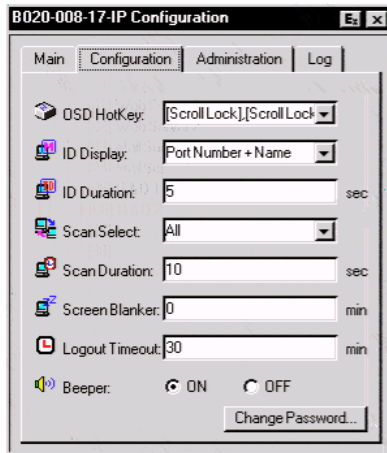

The Configuration page settings are explained in the table on the following page.

(Continues on next page.)

(Continued from previous page.)

Setting	Function
OSD Hotkey	Selects which Hotkey controls the OSD function: [Scroll Lock] [Scroll Lock] or [Ctrl] [Ctrl] . Since the Ctrl key combination may conflict with programs running on the computers, the default is the Scroll Lock combination.
ID Display	Selects how the Port ID is displayed: the Port Number alone (PORT NUMBER); the Port Name alone (PORT NAME); or the Port Number plus the Port Name (PORT NUMBER + PORT NAME). The default is PORT NUMBER + PORT NAME.
ID Duration	Determines how long a Port ID displays on the monitor after a port change has taken place. You can choose an amount from 0 - 255 seconds. The default is 5 Seconds. 0 is Always On.
Scan Select	Selects which computers will be accessed under Auto Scan Mode (see <i>Auto Scanning</i> , page 94). Choices are: ALL - All the Ports which have been set Accessible (see <i>Port Access</i> , page 54); POWERED ON - Only those Ports which have been set Accessible and are Powered On; QUICK VIEW - Only those Ports which have been set Accessible and have been selected as Quick View Ports (see <i>Quick View Ports</i> , page 43); QUICK VIEW + POWERED ON - Only those Ports which have been set Accessible and have been selected as Quick View Ports and are Powered On. The default is ALL.
Scan Duration	Determines how long the focus dwells on each port as it cycles through the selected ports in Auto Scan Mode (see <i>Auto Scanning</i> , page 94). Key in a value from 0 - 255 seconds. The default is 10 seconds; a setting of 0 disables the Scan function.
Screen Blanker	If there is no input from the console for the amount of time set with this function, the screen is blanked. Key in a value from 1 - 30 minutes. A setting of 0 disables this function. The default is 0 (disabled).
Logout Timeout	If there is no Operator input for the amount of time set with this function, the Operator is automatically logged out. A login is necessary before the B020-008-17-IP can be accessed again. Enter a value from 0 - 180 minutes. The default is 30 minutes. 0 disables the function.
Beeper	When set to ON , the beeper sounds whenever the port is switched, when activating the Auto Scan function (see <i>Auto Scanning</i> , page 94), or when an invalid entry is made on an OSD menu. The default is ON.
Change Password	Allows a user to change the account password. After clicking the Change Password button, a dialog box appears. Enter the old password. Then, enter a new password and confirm it by entering it again. Press OK to save changes, or press Cancel to discard changes.

The Administration Page

When you click the Administration tab, the Administration page comes up. Each of the administrative functions is represented by an icon at the left of the page. Clicking the icon brings up its associated dialog box. When the Administration page first comes up the *General* dialog box appears:

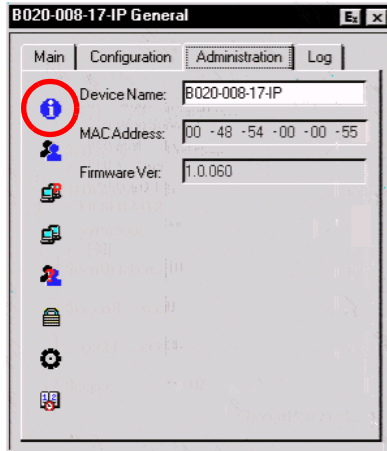

General

The General Page presents four items of information. This is the same information that displays after you log in from a browser, or when you click the *General* icon at the top left of the browser main page. The meaning of these items is described in the table below:

Item	Description
Device Name	This field lets you give the switch a unique name. This can be convenient when you need to differentiate among several devices in multi-station installations.
MAC Address	This item displays the B020-008-17-IP's MAC address.
Firmware Ver	This item displays the current firmware version number. You can reference it to see if there are newer versions available on the Tripp Lite Website.

User Management

The User Management dialog box is used to create and manage user profiles. Up to 64 user profiles can be established.

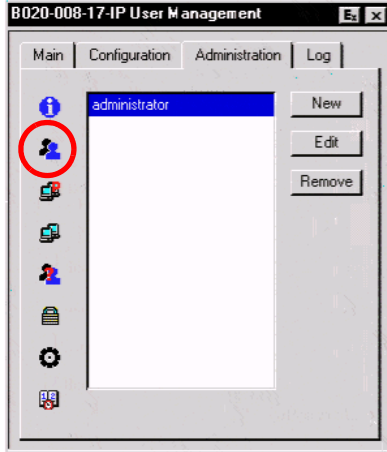

- ◆ To delete a user profile, select it in the list box, and Click **Remove**.
- ◆ To modify a user profile, select it and Click **Edit**.
- ◆ To add a user, Click **New**.

If you choose *Edit* or *New*, a dialog box similar to the one below appears:

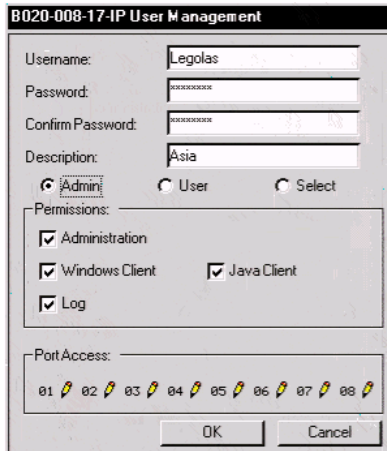

Fill in the required information for a new profile, or modify the existing information to edit a previous profile. A description of the field headings is given in the table below:

Heading	Description
Username	A minimum of 6 and a maximum of 15 characters is allowed.
Password	A minimum of 8 and a maximum of 15 characters is allowed.
Confirm Password	To be sure there is no mistake in the password, you are asked to enter it again. The two entries must match.
Description	Additional information about the user that you may wish to include.
Admin	Enabling this gives the user Administrator level access to the B020-008-17-IP. All permissions are granted. (See <i>Permissions</i> , in this table.)
User	Enabling this gives the user User level access to the B020-008-17-IP. Windows Client, Power Manager, and Java Client permissions are granted. (See <i>Permissions</i> , in this table.)
Select	This button is automatically enabled if the permission choices selected by the Administrator (in the panel just below) do not match the default access level choices for Admin or User.
Permissions	<p>These are used together with the <i>Select</i> radio button to set up permissions that differ from the defaults for Admin and User.</p> <ol style="list-style-type: none"> 1. Checking <i>Administration</i> gives a User administration privileges, which allows him to set up and modify the B020-008-17-IP's Administration page settings. 2. Checking <i>Windows Client</i> allows a user to access the B020-008-17-IP via the Windows Client software. By default, all users may access the B020-008-17-IP via the Windows Client software. 3. Checking <i>Log</i> allows a User to view and query the log file. The <i>Log</i> and <i>Log Server</i> buttons appear on the Main web page of Users who have Log permission (see <i>Webpage Buttons</i>, page 75). 4. Checking <i>Java client</i> allows a User to access the B020-008-17-IP via the Java Client software.

(Continues on next page.)

(Continued from previous page.)

Heading	Description
Port Access	<p>This function allows the Administrator or a User with <i>Administration</i> permission to define the selected User's access to the computers on a Port-by-Port basis.</p> <p>For each User profile, select a port and click it to cycle through the choices:</p> <p>Full - The user can view the screen and can perform operations on the system from the keyboard and mouse.</p> <p>View - A diagonal line through the port icon indicates the port access is View. The user can view the screen, but cannot perform operations on the system.</p> <p>Null (no access rights) - An X through the port icon indicates no port access. The Port will not show up on the User's list on the Main Screen.</p> <p>Repeat until access rights have been set for all ports.</p> <p>The default is Full for all users on all Ports.</p>

B020-008-17-IP User Management

Username: Meriadoc

Password: [REDACTED]

Confirm Password: [REDACTED]

Description: East Europe

Admin User Select

Permissions:

- Administration
- Windows Client Java Client
- Log

Port Access:

01 02 03 04 05 06 07 08

OK Cancel

Service Configuration

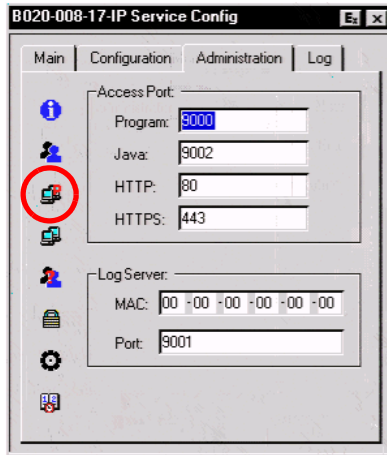

Access Port

As a security measure, if a firewall is being used, the Administrator can specify the port numbers that the firewall will allow, and set the firewall accordingly. Users must specify the port number when they log in to the B020-008-17-IP. If an invalid port number (or no port number) is specified, the B020-008-17-IP will not be found.

An explanation of the fields is given in the table below:

Field	Explanation
Program	This is the port number that must be specified when connecting from the Windows Client software program. Valid entries are from 1024-60,000. The default is 9000.
Java	This is the port number used for Java Client connections. Valid entries are from 0-65535. The default is 9002.
HTTP	The port number for a browser login. The default is 80.
HTTPS	The port number for a secure browser login. The default is 443.

Note: 1. If there is no firewall (on an intranet, for example), it doesn't matter what these numbers are set to, since they have no effect.

2. You must set different values for each of the service ports.

Log Server

Important transactions that occur on the B020-008-17-IP, such as logins and internal status messages, are kept in an automatically generated log file. In this panel, you specify the MAC address and a port number for the computer that the Log Server resides on.

Installation and operation of the Log Server is discussed in Chapter 9. The Log File is discussed in Chapter 8.

Network

The Network dialog is used to specify the B020-008-17-IP's network environment.

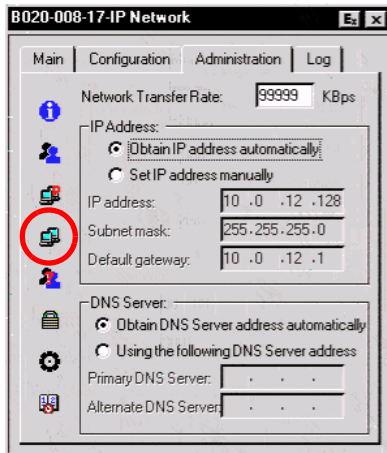

Network Transfer Rate

Set the rate at which the B020-008-17-IP transfers data to remote computers. The range is from 8 to 99999 Kilobytes per second (KBps).

IP Address

The B020-008-17-IP can either have its IP address assigned dynamically (DHCP), or it can be given a fixed IP address.

- ◆ For dynamic IP address assignment, select the *Obtain IP address automatically* radio button.
- ◆ To specify a fixed IP address, select the *Set IP address manually* radio button and fill in the IP address, subnet mask and default gateway.

DNS Server

- ◆ For automatic DNS Server address assignment, select the *Obtain DNS Server address automatically*, radio button.
- ◆ To specify the DNS Server address manually, select the *Use the following DNS Server* radio button, and fill in the addresses for the Primary and Alternate DNS servers.

Note: Specifying at the primary DNS Server address is mandatory. The alternate DNS Server address is optional.

ANMS

The Advanced Network Management Settings dialog box allows you to set up login authorization management from a external sources. It is divided into two main panels, as described, below:

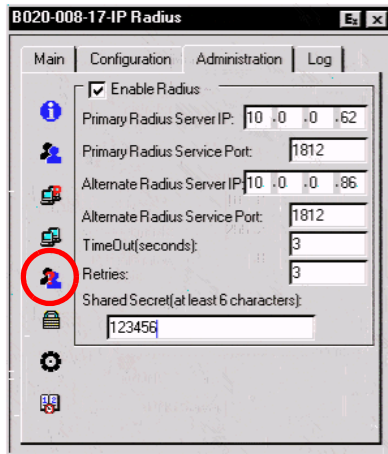

RADIUS Settings

To allow authorization for the B020-008-17-IP through a RADIUS server, do the following:

1. Check **Enable Radius**.
2. Fill in the IP addresses and Service Ports for the Primary and Alternate RADIUS servers.
3. Set the time in seconds that the B020-008-17-IP waits for a RADIUS server reply before it times out in the Timeout field.
4. Set the number of RADIUS retries allowed in the Retries field.
5. Key the *Shared Secret* character string that you want to use for authentication between the B020-008-17-IP and the RADIUS Server in this field.

Note: Set the access rights for each user on the RADIUS server according to the information in the table on the next page.

RADIUS Server Access Rights Table:

Character	Meaning
C	Grants the user administrator privileges, allowing the user to configure the system.
W	Allows the user to access the system via the Windows Client program.
J	Allows the user to access the system via the Java Client program.
L	Allows the user to access log information via the user's browser.
PN	Restricts the user from accessing specified ports on the OSD port list. Syntax: PN/1/2/3/4 (etc.)
PV	Limits the User to only being able to view specified ports on the OSD port list. Syntax: PV/1/2/3/4 (etc.)
UHK	Defines the OSD Hotkey (see page 50). UHK0: Scroll Lock + Scroll Lock UHK1: Ctrl + Ctrl
UOL	Defines the OSD List Function (see <i>The Main Page</i> , and, <i>Quick View Ports</i> , page 43). UOL0: All UOL1: Powered On UOL2: Quick View UOL3: Quick View +Powered On
UODM	Selects how the Port ID displays (see page 50). UODM0: Port Number + Port Name UODM1: Port Number UODM2: Port Name
UODT	Determines the length of time in seconds that the Port ID displays on the monitor after a port change (see page 50). Syntax: UODT n (where n represents a number from 0-255)
UBUZ	Turns the beeper off or on (see page 50). UBUZ0: Beeper Off UBUZ1: Beeper On
ULT	Sets the Logout Timeout. When there is no input from the user for the amount of time set with this function, the user is automatically logged out and will need to log in again. The valid Logout Timeout range is from 0-180 minutes. Syntax: ULT n (where n represents a number from 0 to 180 minutes.

(Continues on next page.)

(Continued from previous page.)

Character	Meaning
USM	Selects which computers the User can access under Auto Scan Mode (see <i>Scan Select</i> , page 50). USM0: All USM1: Powered On USM2: Quick View USM3: Quick View + Powered On
UST	Determines the length of time in seconds the KVM focus dwells on each port in Auto Scan Mode (see <i>Scan Duration</i> , page 50). Syntax: UST n (where n represents a number from 0-255)

- Note:**
1. Characters are not case sensitive. Upper or lower case works equally well.
 2. Characters are comma delimited.
 3. An invalid character in the configuration string will prohibit access to the B020-008-17-IP for the user.
-

RADIUS Server Access Rights Examples:

Character	Meaning
c,w	User has administrator privileges; user can access the system via the Windows Client.
w,j,l	User can access the system via the Windows Client; user can access the system via the Java Client; user can access log information via the user's browser.

CC Management Settings

To allow authorization for the B020-008-17-IP through a CC (Control Center) server, check *Enable CC Management* and fill in the CC Server's IP address and the port that it listens on in the appropriate fields.

Security

The Security page controls access to the B020-008-17-IP.

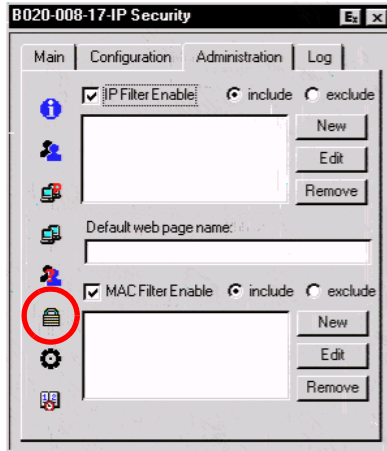

IP and MAC Filtering

- ◆ If any filters have been configured, they appear in the IP Filter and/or MAC Filter list boxes.
- ◆ IP and MAC Filters control access to the B020-008-17-IP based on the IP and/or MAC addresses of the computers attempting to connect. A maximum of 100 IP filters and 100 MAC filters are allowed. To enable IP and/or MAC filtering, **Click** to put a check mark in the *IP Filter Enable* and/or *MAC Filter Enable* checkbox.
 - ◆ If the include button is checked, all the addresses within the filter range are allowed access; all other addresses are denied access.
 - ◆ If the exclude button is checked, all the addresses within the filter range are denied access; all other addresses are allowed access.
- ◆ To add a filter, click **New**. A dialog box similar to the ones below appears:

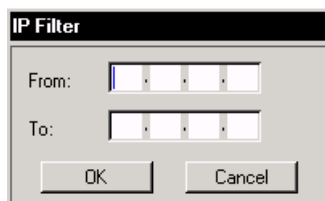

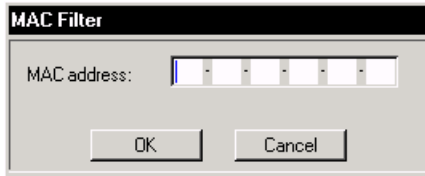

Note: Each IP filter can consist of a single address, or a range of addresses. To filter a single IP address, key in the same address in both the From and To fields. To filter a continuous range of IP addresses, key in the start of the range in the From field; key in the end of the range in the To field.

After you specify the filter addresses, click OK.

- ◆ To delete a filter, select it in the IP Filter and/or MAC Filter list boxes and click **Remove**.
- ◆ To modify a filter, select it in the IP Filter and/or MAC Filter list boxes and click **Edit**. The Edit dialog box is similar to the New dialog box. When it comes up, simply delete the old address and replace it with the new one.

Default Webpage Name

- ◆ The Default web page name entry field lets the Administrator specify a login string (in addition to the IP address) that the user must include when accessing the B020-008-17-IP with a browser. For example:

192.168.0.126/abcdefg

- ◆ The user must include the forward slash and the string along with the IP address. For security purposes, we recommend that you change this string from time to time.

Note: If no string is specified here, anyone will be able to access the B020-008-17-IP with the Web browser using the IP address alone. This makes your installation less secure.

Customization

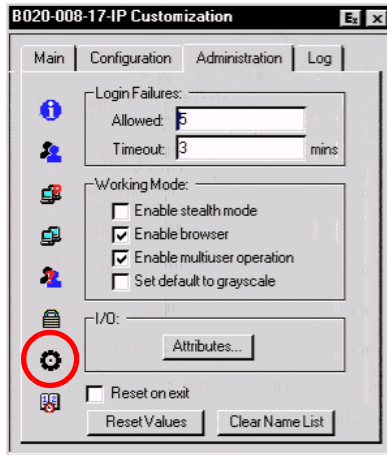

The Customization dialog box is arranged in four major sections: Login Failures; Working Mode; I/O; and untitled miscellaneous functions at the bottom. The functions of each of the Customization items are described in the sections that follow:

Login Failures

- ◆ **Allowed:** sets the number of consecutive failed login attempts that are permitted from a remote computer.
- ◆ **Timeout:** sets the amount of time a remote computer must wait before attempting to login again after it has exceeded the number of allowed failures.

(Continues on next page.)

(Continued from previous page.)

Working Mode

- ◆ If *Stealth Mode* is enabled, the B020-008-17-IP cannot be pinged.
- ◆ To permit browser access to the B020-008-17-IP, click to put a check mark in the *Enable Browser* checkbox. If browser access is not enabled, users will not be able to log into the unit via their browsers.
- ◆ If *Multiuser Operation* is enabled, up to 32 users can simultaneously access the B020-008-17-IP.
- ◆ If *Set default to grayscale* is enabled, the remote display is changed to grayscale. This can speed up I/O transfer in low bandwidth situations.

I/O

- ◆ Attributes

Clicking the *Attributes* button brings up a dialog box that allows you to set *Share mode* and *Timeout* threshold for each of the ports:

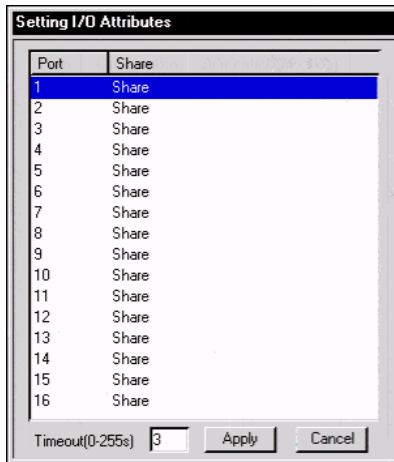

(Continues on next page.)

(Continued from previous page.)

- ◆ To set a port's Share mode, double click it to bring up the I/O attributes dialog box:

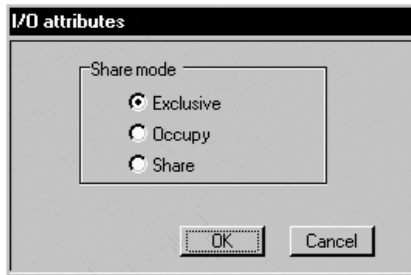

Set the port's Share mode according to the information in the following table::

Attribute	Action
Exclusive:	The first user to occupy the port has exclusive control over it. No other user can view or access it.
Occupy:	The first user to occupy the port has control over it. Up to 31 additional users can view its video output, however. The <i>Timeout</i> function discussed on page 65 applies to ports that have this setting.
Share:	Allows up to 32 users to simultaneously share control over the port. User input is placed in a queue and executed on a first sequentially. In addition, a user can access the B020-008-17-IP's <i>Message Board</i> function to gain control of the keyboard and mouse, or keyboard, video, and mouse of a Share designated port. See <i>The Message Board</i> , page 87.

- ◆ The *Timeout* field sets a time threshold for users on ports whose Share Mode has been set to *Occupy* (see *Occupy*:, page 65). If there is no activity from the user occupying the port for the amount of time set here, the user is timed out and the port is released. The first user to send keyboard or mouse input after the port has been released gets to occupy the port. Input a value from 0 to 255 seconds. The default is 3 seconds. A setting of 0 causes the port to be released the instant there is no input.

Miscellaneous

The functions performed by the remaining elements at the bottom of the screen are described in the table below:

Parameter	Explanation
Reset on exit	Place a check here to have the B020-008-17-IP reset itself and implement all the new settings when you log out. Following the reset, wait one to two minutes before logging back in. Note: For some changes the <i>Reset on exit</i> check box is automatically selected and the KVM switch will reset when you log out. Clearing the check mark before logging out will cause the new settings to be discarded.
Reset Values	Clicking this button undoes all changes that have been made to the Configuration and Administration pages (except for port names, usernames, and passwords) and returns the parameters to the original factory default settings (see <i>OSD Factory Default Settings</i> , page 133).
Clear Name List	This function clears the Port Names on the Main page.

Date/Time

The Date/Time dialog box lets the Administrator set up the B020-008-17-IP's time parameters:

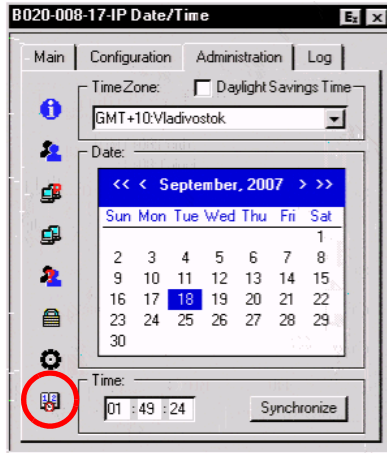

- ◆ If your country or region employs Daylight Saving Time (Summer Time), check the corresponding box.
- ◆ To establish the time zone that the B020-008-17-IP is located in, drop down the *Time Zone* list and choose the city that most closely corresponds to where it is at.
- ◆ To set the year and day, use the Calendar graphic.
 - ◆ Clicking < or > moves you backward or forward by one month increments.
 - ◆ Clicking << or >> moves you backward or forward by one year increments.
 - ◆ In the calendar, click on the day.
- ◆ To set the time, use the 24 hour HH:MM:SS format.
- ◆ Click **Synchronize** to save your settings.

The Log Page

Clicking the Log tab brings up the contents of the log file. The log file is discussed in Chapter 8.

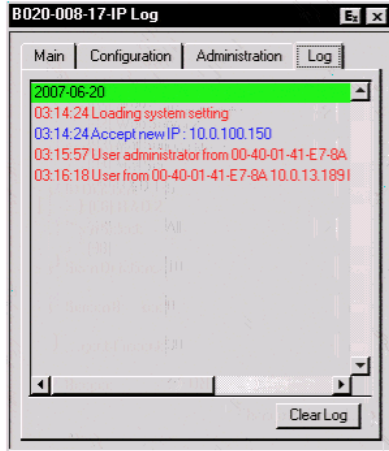

Upgrading the Firmware

As new versions of the B020-008-17-IP firmware become available, they can be downloaded from our Website.

Note: Although upgrading the firmware isn't on the OSD Administration page, it is an administrative function, so we chose to discuss it in this chapter.

To upgrade the firmware, do the following:

1. Download the new firmware file to a computer that is not part of your B020-008-17-IP installation.
2. From that computer, open your browser and log in to the B020-008-17-IP (see *Logging In*, page 71).
3. Click the **Firmware** icon (see *Webpage Icons*, page 73) to open the *Firmware configuration* dialog box:

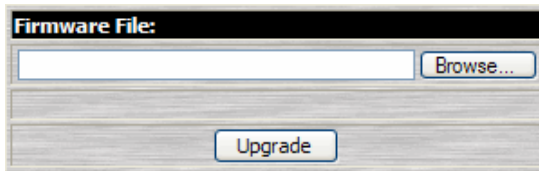

4. Click **Browse**; navigate to the directory that the new firmware file is in and select the file.
5. Click **Upgrade**.
6. After the upload completes, click the **Logout** icon to exit and reset the B020-008-17-IP.

This Page Intentionally Left Blank

Chapter 5

Browser Operation

Overview

An On Screen Display (OSD) interface governs B020-008-17-IP computer control and switching operations. The OSD can be accessed remotely with a Windows-based client or a Java-based client. You must log in via an Internet browser to connect to the B020-008-17-IP and to invoke the OSD.

Logging In

To log in from an Internet browser:

1. Open the browser and specify the IP address and Default Webpage name (if one has been specified) for the B020-008-17-IP in the URL bar.

Note: If you don't know the IP address and Default Webpage name, get it from the B020-008-17-IP administrator.

2. When the *Security Alert* dialog box appears, accept the certificate – it can be trusted. (See *Trusted Certificates*, page 134, for details.) A login page appears:

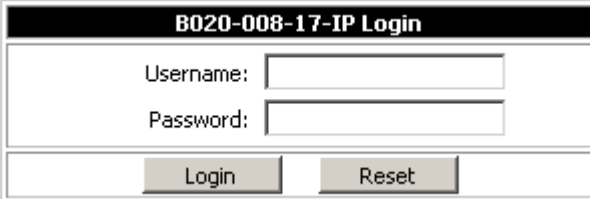

B020-008-17-IP Login	
Username:	<input type="text"/>
Password:	<input type="password"/>
<input type="button" value="Login"/>	<input type="button" value="Reset"/>

3. Provide a valid Username and Password (set up by the B020-008-17-IP administrator), then Click **Login** to continue.

Note: 1. If you supply an invalid login, the authentication routine will return a message stating, *Invalid Username or Password. Please try again.* If you exceed the number of login failures set by the administrator, a message stating that *The page cannot be displayed,* appears. This is done to confuse and discourage hackers from trying to discover a valid Username and Password. If you see this message, try logging in again being careful with the Username and Password.

2. If you are the Administrator and are logging in for the first time, use the default Username: *administrator*; and the default Password: *password*. For security purposes, we strongly recommend you remove these and give yourself a unique Username and Password (see *User Management*, page 52).
-

After you have successfully logged in, the B020-008-17-IP Main webpage appears with the *General* dialog box displayed:







Note: This is the same dialog box that appears whenever you click the *General* icon at the top left of the page.

Webpage Layout

Webpage Icons

The purpose of the icons at the top of the Webpage are explained in the table below:

Icon	Function
	<p>Click this icon to display the General dialog box. See <i>The General Dialog Box</i>, page 74, for an explanation of the dialog box fields.</p>
	<p>Click this icon to synchronize the B020-008-17-IP's time with your computer's time.</p> <ul style="list-style-type: none"> ◆ If both are in the same time zone, the device's time is changed to match the computer's time. ◆ If they are in different time zones, the device's time is changed to match the computer's time, except that the time zone difference is still maintained.
	<p>Click this icon to install new versions of the B020-008-17-IP's firmware. See page 69 for details.</p> <p>Note: The Firmware icon only displays for users with administrative permission. It doesn't appear on the Webpages of users who don't have the proper permission.</p>
	<p>You should always click this icon to log out and end your B020-008-17-IP session. If you close the browser without first logging out, you will have to wait approximately one minute before logging in again unless multiuser operation is enabled (see <i>Customization</i>, page 63).</p>

The General Dialog Box







The General dialog box is the default Webpage. An explanation of the dialog box fields is given in the table below:

Field	Purpose
Device Name	To make it easier to manage installations that have more than one B020-008-17-IP.
MAC Address	The B020-008-17-IP's MAC Address displays here.
Firmware Version	Indicates the B020-008-17-IP's current firmware version level.
Network Transfer Rate	Displays the currently selected rate for data transmission. The network transfer rate is administrator selectable – see <i>Network Transfer Rate</i> , page 56.
Reset on exit	Select this check box to reset the B020-008-17-IP and implement new settings when you log out. Following a reset, wait one to two minutes before logging back in. (This check box is only enabled for users who have administration privileges.) Note: For some changes the <i>Reset on exit</i> check box is automatically selected and the KVM switch will reset when you log out. Clearing the check mark before logging out will cause the new settings to be discarded.
Last IP from DHCP server	Displays the current IP address of the B020-008-17-IP.

Note: New versions of the B020-008-17-IP's firmware can be downloaded from our Website as they become available. See page 69 for details.

Webpage Buttons

The purpose of the buttons at the left of the Webpage are explained in the table below:

Icon	Purpose
	<p>Click this button to download the Windows Client software to remotely control the connected computer(s).</p> <p>Note: You must download a new Windows Client each time you log in from your browser.</p>
	<p>For platform independence, the Java client allows users that have Java installed to connect to the B020-008-17-IP. Click this button to download the Java Client software to remotely control the connected server(s).</p> <p>Note: You must download a new Java Client each time you log in from your browser.</p>
	<p>In some instances, administrators don't want the B020-008-17-IP to be accessible by browser. Clicking this button allows the user to download the API version of the Windows Client. Once a user has downloaded the API program, the administrator can turn off browser access. API operation is discussed in Chapter 9.</p>
	<p>In some instances, administrators don't want the B020-008-17-IP to be accessible by browser. Clicking this button allows the user to download the API version of the Java Client. Once a user has downloaded the API program, the administrator can turn off browser access. API operation is discussed in Chapter 9.</p>
	<p>Clicking this button allows the administrator to download and install the Log Server application. See Chapter 9 for Log Server details.</p>
	<p>All the events that take place on the B020-008-17-IP are recorded in a log file. Clicking this icon displays the contents of the log file.</p>

This Page Intentionally Left Blank

Chapter 6

Windows Client Port Operation

Activating the OSD

After you have successfully logged in (see page 71), to activate the browser-based Windows Client OSD do the following:

1. Click the *Windows Client* button (the one without the arrow) at the left of the Webpage.

Note: 1. You must have DirectX 7.0 or higher installed on your computer. If not, the Windows Client will not load. If you don't already have it, DirectX is available for free download from Microsoft's Website: <http://www.microsoft.com/downloads>.

2. The Windows Client button with the arrow is for running the AP version of the Windows Client (see page 119 for details).
-

2. When the file download security warning dialog box appears, click **Run**.
3. If a second security warning dialog box appears, click **Run** again.

Note: 1. If the browser cannot run the file, save it to disk, instead. Then, with your browser still open to the B020-008-17-IP Webpage, run the file from your disk.

2. If you use the *save to disk* method, for security purposes, you cannot simply run a previously downloaded version of the program. Each time you want to access the B020-008-17-IP, you must log in to the Webpage with a valid username and password to download a fresh copy of the program.
-

(Continues on next page.)

(Continued from previous page.)

4. When a connection to the B020-008-17-IP has been established a screen similar to the one below appears:

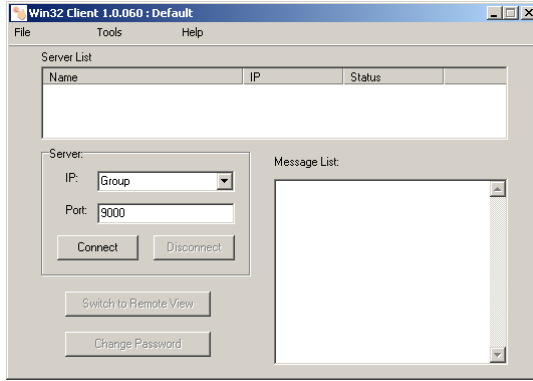

5. Click on **Connect** and the B020-008-17-IP Window Client login screen appears:

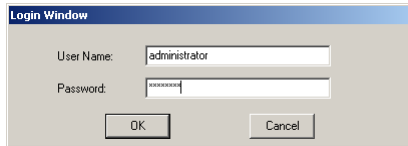

6. Provide a valid Username and Password (set up by the B020-008-17-IP administrator), then Click **Login** to continue.

-
- Note:** 1. If you supply an invalid login, the authentication routine will return a message stating, *Invalid Username or Password. Please try again.* If you exceed the number of login failures set by the administrator, a message stating that *The page cannot be displayed,* appears. This is done to confuse and discourage hackers from trying to discover a valid Username and Password. If you see this message, try logging in again being careful with the Username and Password.
2. If you are the Administrator and are logging in for the first time, use the default Username: *administrator*; and the default Password: *password*. For security purposes, we strongly recommend you remove these and give yourself a unique Username and Password (see *User Management*, page 52).
-

7. After you have successfully logged in, the *Windows Client Main* screen reappears with the *Message List* indicating the server is ready and the **Switch to Remote View** and **Change Password** buttons activated:

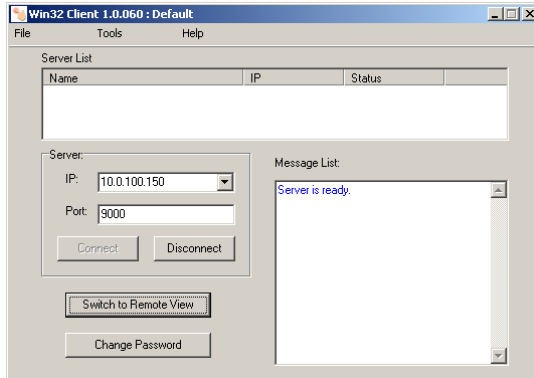

8. Click on **Switch to remote View** to bring up the OSD.

The Windows Client OSD

After you switch to the B020-008-17-IP the OSD comes up with the *Main* page and *Windows Client Control Panel* displayed:

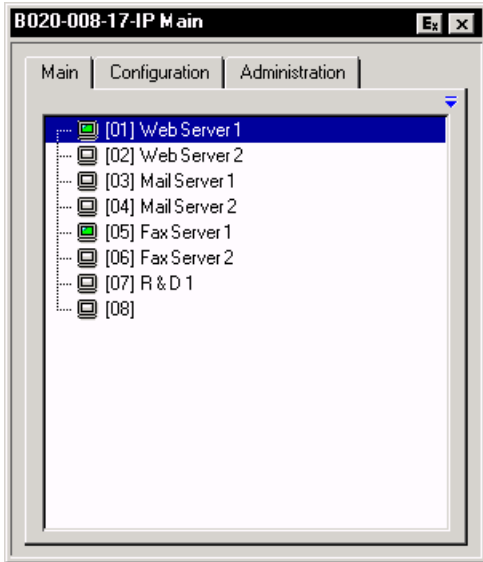







The OSD consists of three pages – Main, Configuration, and Administration.

- ◆ The Configuration and Administration pages are discussed in Chapter 4.
- ◆ The Main page is introduced later in this chapter, on page 90.

Note: The *Administration* tab is disabled for users who don't have administration privileges.

Windows Client Control Panel

The control panel consists of an icon bar at the top, with two text bars below it. Initially, the text bars display the video resolution and IP address of the device at the remote location. As the mouse pointer moves over the icons in the icon bar, however, the text bar information changes to describe the icon's function. The functions that the icons perform are described in the table below.

Icon	Function
	Click and drag to move the control panel to another position on the screen.
	Click to bring up the Hotkey Setup dialog box (see <i>Hotkey Setup</i> , page 82 for details).
	Click to bring up the Video Options dialog box. Right-click to perform a quick Auto Sync (see <i>Video Adjustment</i> , page 84).
	Click to bring up the Message Board (see page 87).
	Click to send a Ctrl+Alt+Del signal to the remote system.
	Click to exit the remote view.
(Space)	Hover over the space to see the video resolution and IP address of the device at the remote location.
	<p>These Lock Key LEDs show the Num Lock, Caps Lock, and Scroll Lock status of the remote computer. Click on the icon to toggle the status.</p> <p>Note: When you first connect, the LED display may not be accurate. To be sure, click on the LEDs to set them.</p>

Hotkey Setup

Various configuration actions related to the keyboard, video, and mouse can be performed via hotkey combinations. The Hotkey setup utility is accessed by clicking the *Keyboard* icon on the Control Panel. The actions performed by the Hotkeys are listed in the left panel; the currently defined keys that invoke the actions are shown in the panel to the right.

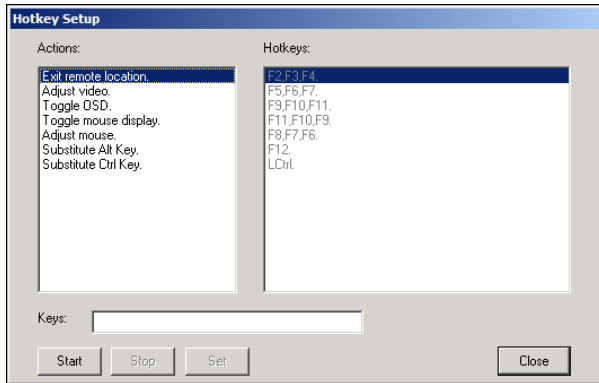

If you find the default Hotkey combinations inconvenient, you can re-configure them by following these five steps:

1. Highlight the Action, and then Click **Start**.
2. Key in the Function keys (one at a time). The key names appear in the *Key* field as you press them.
3. When you have finished keying in your sequence, Click **Stop**.
4. Click **Set**. Repeat for any other actions for which you wish to re-assign Hotkeys.
5. Click **Close**.

Note: You can use the same function keys for more than one action, *as long as the first key is not the same*. For example, you can use **F1 F2 F3** for one action; **F2 F1 F3** for another; **F3 F2 F1** for a third, etc.

(Continues on next page.)

(Continued from previous page.)

An explanation of the Hotkey actions is given in the table below:

Action	Explanation
Exit remote location	Breaks the connection to the B020-008-17-IP and returns you to local operation.
Adjust Video	Brings up the video adjustment utility.
Toggle OSD	Toggles the OSD display Off and On.
Toggle mouse display	If you find the display of the two mouse pointers (local and remote) to be confusing or annoying, you can use this function to shrink the non-functioning pointer down to a barely-noticeable tiny circle - which can be ignored. Since this function is a toggle - use the hotkeys again to bring the mouse display back to its original configuration.
Adjust mouse	This utility synchronizes the local and remote mouse movements following a video resolution change. After invoking this utility, simply click the local mouse pointer on top of the remote mouse pointer.
Substitute Alt key	Although all other keyboard input is captured and sent to the B020-008-17-IP, [Alt + Tab] and [Ctrl + Alt + Del] work on your local computer. In order to implement their effects on the remote system, another key - may be substituted for the Alt key. If you substitute the F12 key, for example, you would use [F12 + Tab] and [Ctrl + F12 + Del].
Substitute Ctrl key	If your local computer captures Ctrl key combinations, preventing them from being sent to the remote system, you can implement their effects on the remote system by specifying a function key to substitute for the Ctrl key. If you substitute the F11 key, for example, pressing [F11 + 5] would appear to the remote system as [Ctrl + 5].

Note: To invoke an action, you must press and release the keys one key at a time.

Video Adjustment

You can adjust the placement and the picture quality of the remote screen (as displayed on your local monitor) with the Video Options function. To do so, either click on the Hammer icon on the Control Panel, or use the *Adjust Video* hotkeys (see *Hotkey Setup*, page 82). The following screen appears:

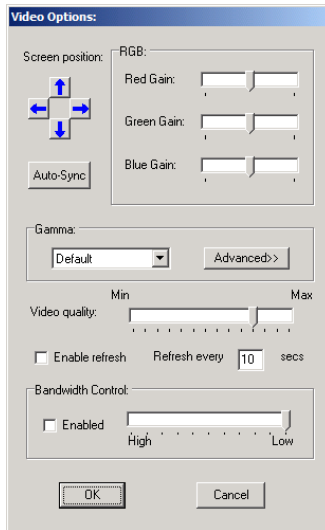

The meanings of the adjustment options are given in the table below.

:

Option	Usage
Screen Position	Adjust the horizontal and vertical position of the remote computer window by Clicking the Arrow buttons.
Auto-Sync	<p>Click Auto-Sync to have the function detect the vertical and horizontal offset values of the remote screen and automatically synchronize it with the local screen.</p> <p>If the local and remote mouse pointers are out of sync, in most cases, performing this function will bring them back into sync.</p> <p>Note: This function works best with a bright screen.</p> <p>If you are not satisfied with the results, use the Screen Position arrows to position the remote display manually.</p>
RGB	Drag the slider bars to adjust the RGB (Red, Green, Blue) values. When an RGB value is increased, the RGB component of the image is correspondingly increased.
Gamma	This section allows you to adjust the video display's gamma level. This function is discussed in detail in the next section, <i>Gamma Adjustment</i> .
Video Quality	Drag the slider bar to adjust the overall Video Quality. Values can be from 20 to 100. The larger the value, the clearer the picture and the more video data goes through the network. Depending on the network bandwidth, a high value may adversely effect response time.
Enable Refresh	The B020-008-17-IP can redraw the screen every 1 to 99 seconds, eliminating unwanted artifacts from the screen. Select Enable Refresh and enter a number from 1 through 99. The B020-008-17-IP will redraw the screen at the interval you specify. This feature is disabled by default. Click to put a check mark in the box next to <i>Enable Refresh</i> to enable this feature.
Bandwidth Control	This setting adjusts the ratio between picture quality and network speed. For slow data connections, drag the slider bar to a lower setting to decrease the amount of video data transferred. This ensures screen refresh at workable speeds.

Gamma Adjustment

If it is necessary to correct the gamma level for the remote video display, use the *Gamma* function of the Video Adjustment dialog box.

- ◆ Under *Basic* configuration, there are ten preset and four user-defined levels to choose from. Drop down the list box and choose the most suitable one.
- ◆ For greater control, clicking the *Advanced* button brings up the following dialog box:

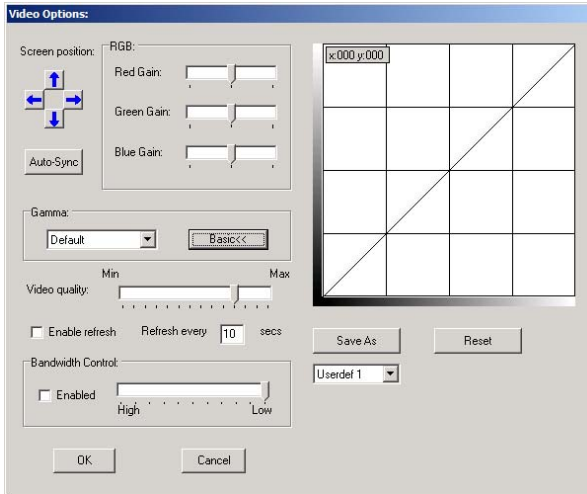

- ◆ Click and drag the diagonal line at as many points as you wish to achieve the display output you desire.
- ◆ Click **Save As** to save up to four user-defined configurations derived from this method. Saved configurations can be recalled from the list box at a future time.
- ◆ Click **Reset** to abandon any changes and return the gamma line to its original diagonal position.
- ◆ Click **OK** to save your changes and close the dialog box.
- ◆ Click **Cancel** to abandon your changes and close the dialog box.

Note: For best results, change the gamma while viewing a remote computer.

The Message Board



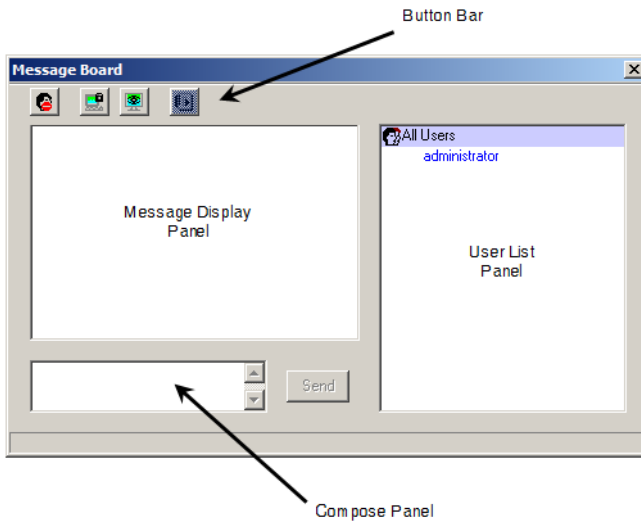

The B020-008-17-IP supports multiple user logins, which can possibly give rise to access conflicts. To alleviate this problem, a message board feature has been provided, allowing users to communicate with each other.

The message board functions much like an Internet chat program does. When you click the Message Board icon on the Windows Client Control Panel (see page 81), a screen similar to the one below appears:



The Button Bar

The buttons on the Button Bar are toggles. Their actions are described in the table below:

Button	Action
	<p>Enable/Disable Chat. When disabled, messages posted to the board are not displayed. The button is shadowed when Chat is disabled. The icon displays next to the user's name in the User List panel when the user has disabled Chat.</p>
	<p>Occupy/Release Keyboard/Video/Mouse. When you Occupy the KVM, other users cannot see the video, and cannot input keyboard or mouse data. The button is shadowed when the KVM is occupied. The icon displays next to the user's name in the User List panel when the user has occupied the KVM.</p>
	<p>Occupy/Release Keyboard/Mouse. When you Occupy the KM, other users can see the video, but cannot input keyboard or mouse data. The button is shadowed when the KM is occupied. The icon displays next to the user's name in the User List panel when the user has occupied the KM.</p>
	<p>Show/Hide User List. When you Hide the User List, the User List panel closes. The button is shadowed when the User List is open.</p>

Message Display Panel

Messages that users post to the board - as well as system messages - display in this panel. If you disable Chat, however, messages that get posted to the board won't appear.

Compose Panel

Key in the messages that you want to post to the board in this panel. Click **Send**, or press **[Enter]** to post the message to the board.

User List Panel

The names of all the logged in users are listed in this panel.

- ◆ Your name appears in blue; other users' names appear in black.
- ◆ By default, messages are posted to all users. To post a message to one individual user, select the user's name before sending your message.
- ◆ If a user's name is selected, and you want to post a message to all users, select All Users before sending your message.
- ◆ If a user has disabled Chat, its icon displays before the user's name to indicate so.
- ◆ If a user has occupied the KVM or the KM, its icon displays before the user's name to indicate so.

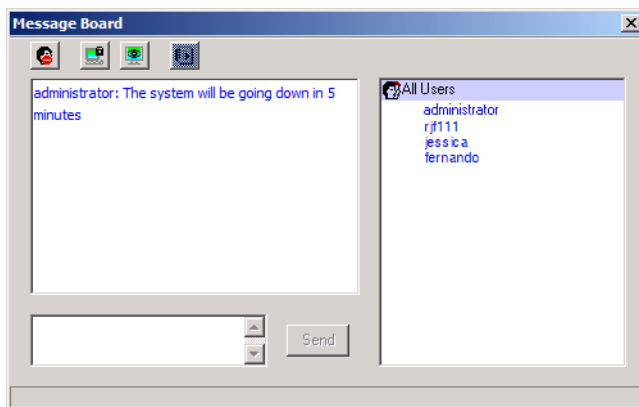



The Main Page

The Main Page (see page 80), lists all of the B020-008-17-IP's ports and governs port access. Selecting a port and double clicking it switches you to the device on that port.

Note: The administrator selects which ports are accessible to each user with the *User Management* function (see page 52 for details).

- ♦ The OSD uses a tree view. To see the ports for a particular station, click the plus sign [+] in front of the Station Number. The Port Number List drops down. To dismiss the list, click the minus sign[–] in front of the Station Number.
- ♦ A *port icon* in the shape of a monitor displays in front of the port number. Ports that have devices connected to them that are up and running have the port icon lit in green.
- ♦ Ports that have been selected as Quick View ports (see below), have a red eye icon displayed with the monitor in the port icon column to indicate so.
- ♦ There are two buttons on the title bar at the top right:

Button	Function
	<i>Log out:</i> clicking this button (or pressing F8) closes the OSD display and logs you out of the B020-008-17-IP session.
	<i>Close:</i> clicking this button (or pressing [Esc]) closes the OSD display but does not log you out of the session. You can bring the display back with the OSD hotkeys (see <i>OSD Hotkey</i> , page 50).

In addition to using this page for port switching, the administrator can also use this page for port management. See *The Main Page*, page 42, in the *Administration* chapter.

Port Operation

Select a port on the OSD Main Screen either by moving the highlight bar to it with the Up and Down Arrow keys and pressing **Enter**, or by **double-clicking** it. Once you select a port, its screen displays on your monitor, and your keyboard and mouse input affects the remote system.

The OSD Toolbar

The OSD provides a toolbar to help you control the B020-008-17-IP from within the captured port. To bring up the toolbar, tap the OSD Hotkey (Scroll Lock or Ctrl) twice. The toolbar appears in the upper left corner of the screen:



Depending on the settings that were selected under *ID Display* (see page 50), the Port Number and/or the Port Name display at the right of the toolbar.

-
- Note:**
1. Click on a free area of the toolbar and drag to move it around the screen.
 2. When the toolbar displays, mouse input is confined to the toolbar area and keyboard input has no effect. To carry out operations on the computer connected to the port, close the toolbar by clicking the **X** on it; or, recall the OSD and select the port again.
-

Recalling the OSD

To dismiss the toolbar and bring back the OSD display (the Main, Configuration, and Administration pages), do one of the following:

- ♦ Tap the OSD Hotkey once.
- ♦ From the toolbar, click the icon that opens the OSD (see *OSD Toolbar Icons*, page 92).

The OSD Toolbar closes, and the main OSD display reappears.









OSD Hotkey Summary Table

The following table presents a summary of the OSD Hotkey actions. See p. 50 to set the OSD Hotkey.

To...	When...	Do This...
Open the OSD Toolbar.	The OSD Toolbar is not open.	Click the OSD Hotkey twice.
Open the OSD.	The OSD Toolbar is open.	Click the OSD Hotkey once.
Open the OSD.	The OSD Toolbar is not open.	Click the OSD Hotkey three times.

OSD Toolbar Icons

The meanings of the toolbar icons are explained in the table below.

	Click to skip to the first accessible port on the entire installation without having to invoke the OSD.
	Click to skip to the first accessible port previous to the current one without having to invoke the OSD.
	Click to begin Auto Scan Mode. The B020-008-17-IP automatically switches among the ports that were selected for Auto Scanning under the Configuration <i>Scan Select</i> function (see page 50). This allows you to monitor their activity without having to switch among them manually.
	Click to skip from the current port to the next accessible one without having to invoke the OSD.
	Click to skip from the current port to the last accessible port on the entire installation without having to invoke the OSD.
	Click to bring up the OSD.
	<p>Transparency: Makes the OSD semi transparent, allowing the background to show through. Clicking again, returns the OSD to normal.</p> <p>Note: 1. We recommend setting your monitor refresh rate to a value greater than 75Hz before using this feature.</p> <p>2. If you switch to a null port when Transparency is enabled, the feature becomes disabled.</p>
	Click to close the toolbar.
	Click to logout and exit the Windows Client application.

Multiuser Operation

The B020-008-17-IP supports multiuser operation. Up to 32 users can log in at the same time. When multiple users simultaneously access the B020-008-17-IP switch from remote computers, the rules of precedence that apply are shown in the following table:

Operation	Rule
General	Once a user invokes the OSD, no other user can invoke it until the original user closes it.
Auto Scan Mode	If a user has invoked Auto Scan Mode (see page 94), but the OSD has not been invoked, another user can interrupt Auto Scan Mode by invoking the OSD.

Keyboard Hotkey Operation

Keyboard hotkey combinations allow you to provide KVM focus to a port directly from the keyboard. The B020-008-17-IP provides the following hotkey features:

- ◆ Auto Scanning
- ◆ Skip Mode Switching

The hotkeys are: **A** and **P** for Auto Scanning; and the **Arrow Keys** for Skip Mode.

-
- Note:**
1. In order for hotkey operations to take place, the OSD Toolbar must be visible (see *Port Operation*, page 91).
 2. To use the keys designated as hotkeys (i.e. A, P, etc.) for normal, non-hotkey purposes, you must first close the toolbar.
 3. For issues affecting multiple user operation in Auto Scan Mode, see *Multiuser Operation*, page 93.
-

Auto Scanning

The Auto Scan function automatically switches among all the ports that are accessible to the currently logged on User at regular intervals, so that the user can monitor their activity automatically. (See *Scan Select*, page 50, for information regarding accessible ports.)

Setting the Scan Interval

The amount of time Auto Scan dwells on each port is set with the *Scan Duration* setting (see page 50).

Invoking Auto Scan

To start Auto Scanning, tap the **A** key. The Auto Scan function cycles through the ports in order - starting from the first port on the installation. An **S** appears in front of the Port ID Display to indicate that the port is being accessed under Auto Scan Mode.

Pausing Auto Scan

While you are in Auto Scan Mode, you can pause the scanning in order to keep the focus on a particular computer by pressing **P**. During the time that Auto Scanning is paused, the **S** in front of the Port ID blinks On and Off.

Pausing when you want to keep the focus on a particular computer is more convenient than Exiting Auto Scan Mode because when you Resume scanning, you start from where you left off. If, on the other hand, you were to exit and restart Auto Scan Mode, the scanning would start from the very first computer on the installation. To resume Auto Scanning, press any key except Esc or the Spacebar. Scanning continues from where it left off.

Exiting Auto Scan

While Auto Scan Mode is in effect, ordinary keyboard functions are suspended. You must exit Auto Scan Mode in order to regain normal control of the keyboard. To exit Auto Scan Mode press **Esc** or the **Spacebar**. Auto Scanning stops when you exit Auto Scan Mode.

Skip Mode

Skip Mode allows you to switch ports in order to monitor the computers manually. You can dwell on a particular port for as long or as little as you like - as opposed to Auto Scanning, which automatically switches after a fixed interval. The Skip Mode hotkeys are the four Arrow keys. Their operation is explained in the table below:

Arrow	Action
←	Skips from the current port to the first accessible port previous to it. (See <i>Scan Select</i> , page 50, for information regarding accessible ports.)
→	Skips from the current port to the first accessible port that comes after it.
↑	Skips from the current port to the very first accessible port on the installation.
↓	Skips from the current port to the very last accessible port on the installation.

Keyboard and Mouse Considerations

Keystrokes

Except for [Alt + Tab] and [Ctrl + Alt + Del], all keyboard input is sent to the remote system. The above two chorded key combinations are retained on the local system to switch among applications and to recover from disaster. In order to provide the [Alt + Tab] and [Ctrl + Alt + Del] functions on the remote system, Function keys (F1 -F12) can be selected as substitute keys for both the **Alt** and **Ctrl** keys.

For example, the **F11** key could substitute for the **Ctrl** key and the **F12** key could substitute for the **Alt** key, in which case [F12 + Tab] substitutes for [Alt + Tab]; and [F11 + F12 + Del] substitutes for [Ctrl + Alt + Del]. See *Hotkey Setup*, page 82, for details on setting up a substitute key.

-
- Note:**
1. While any key may be used as a Substitute key, you *must not* use one that is being used as the first position Hotkey for another action.
 2. When the B020-008-17-IP is being accessed with Win 98 under Full Screen Mode, if you mistakenly press Ctrl + Alt + Del, you will have to exit the Windows Client (by clicking the arrow on the Windows Client control panel), and restart the Windows Client from the B020-008-17-IP Main Webpage.
-

Mouse Synchronization

Until you close the B020-008-17-IP connection, mouse movements have no effect on your local system, but instead are captured and sent to the remote system.

From time to time, especially if you change video resolution, the local mouse movement may no longer be synchronized with the remote system's mouse pointer. There are three quick methods that can be used to bring the two pointers back into sync:

- ◆ Right-clicking on the hammer icon in the Windows Client Control Panel.
- ◆ Moving the mouse pointer into the Control Panel and back out again.
- ◆ Performing an *Auto Sync* with the Video Adjustment function (see *Video Adjustment*, page 84, for details).

If performing these actions does not resolve the problem, do the following:

1. Invoke the *Adjust Mouse* function with the *Adjust Mouse* hotkeys (see *Adjust mouse*, page 83, for details).
2. Move the local mouse pointer exactly on top of the remote mouse pointer and click.

If this procedure still does not help, you should set the mouse speed and acceleration for each problematic computer attached to the switch. See *Additional Mouse Synchronization Procedures*, page 145, for instructions.

This Page Intentionally Left Blank

Chapter 7

Java Client Port Operation

Activating the OSD

After you have successfully logged in (see page 71), to activate the Java Client OSD do the following:

1. Click the *Java Client* button (the one without the arrow) at the left of the Webpage.

Note: You must have Sun's Java 2 JRE 1.4.2 or higher installed on your computer before running the Java Client. (At the time of writing, JRE 5.0 Update 5 was the latest release.) Java is available for free download from the Sun Java Website: <http://java.sun.com>.

2. Accept the security certificates.
3. When the browser dialog asks what to do with the program file, click **Open**.

Note: 1. If the browser cannot run the file, save it to the hard drive. Then, with your browser still open to the B020-008-17-IP Webpage, run the file from your disk.

2. If you use the *save to disk* method, for security purposes, you cannot simply run a previously downloaded version of the program. Each time you want to access the B020-008-17-IP, you must log in to the Webpage with a valid username and password to download a fresh copy of the program.
-

The Java Client OSD

When you bring up the OSD, the Main Screen comes up in the center of your monitor.

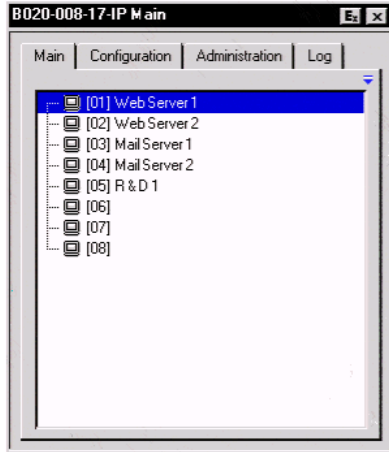

The OSD consists of three pages – Main, Configuration, and Administration.

- ◆ The Configuration and Administration pages are discussed in Chapter 4.
- ◆ The Main page is the same OSD Main page that appears when the Windows Client is invoked. For an explanation of this page refer to the discussion under *The Windows Client OSD*, page 80.

Note: The *Administration* tab is disabled for users who don't have administration privileges.

The Java Client Control Panel

Instead of a control panel like the one that the Windows Client uses, the Java Client has a hidden control panel, located at the bottom center of the screen. The panel becomes visible when the mouse pointer is moved over it.



The Java Client Control Panel icons and their functions are described in the sections that follow.



Set Video Parameters

Clicking this button brings up the *Video Adjustment* dialog box:

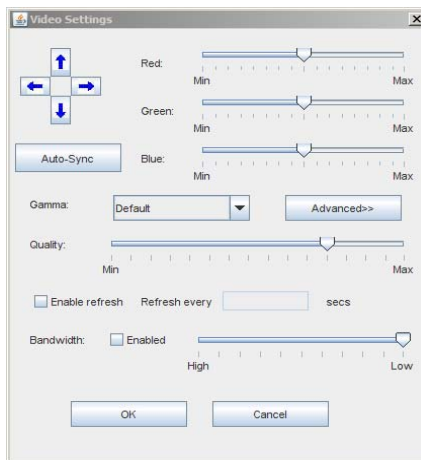

It is similar to the Windows Client Video Adjustment dialog box. See *Video Adjustment*, page 84, for details.



Keypad

Some keyboard combinations cannot be captured and sent to the B020-008-17-IP. In order to implement their effects on the remote system, this function provides a one-click implementation of some common window control combinations.



Mouse Synchronization

At times the local mouse movement may lose sync with the remote mouse movement. The Mouse Synchronization function gets them back into sync. There are two methods available to bring the pointers into sync:

1. Click the Mouse Synchronization button; wait for the remote mouse pointer to move to the upper left corner of the screen; move your local mouse pointer directly on top of the remote pointer, and click.
2. Move your local mouse pointer over the Java Client Control Panel, and click.



Message Board

The B020-008-17-IP supports multiple user logins, which can possibly give rise to access conflicts. To alleviate this problem, a message board feature, similar to an Internet chat program, allows users to communicate with each other.

When you click the Message Board icon on the Java Client Control Panel (see page 101), a screen similar to the one below appears:

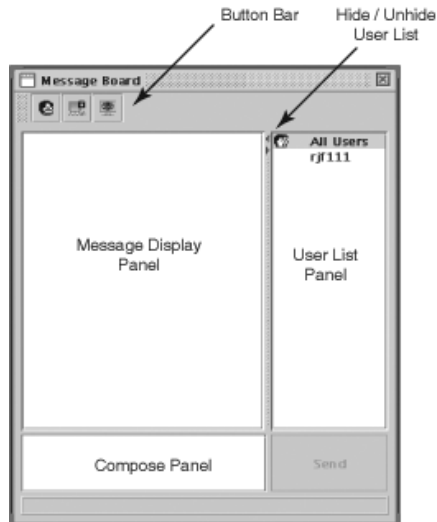



(Continues on next page.)

(Continued from previous page.)

The Message Board Button Bar

The buttons on the Button Bar are toggles. Their actions are described in the table below:

Button	Action
	Enable/Disable Chat. When disabled, messages posted to the board are not displayed. The button is shadowed when Chat is disabled. The icon displays next to the user's name in the User List panel when the user has disabled Chat.
	Occupy/Release Keyboard/Video/Mouse. When you Occupy the KVM, other users cannot see the video, and cannot input keyboard or mouse data. The button is shadowed when the KVM is occupied. The icon displays next to the user's name in the User List panel when the user has occupied the KVM.
	Occupy/Release Keyboard/Mouse. When you Occupy the KM, other users can see the video, but cannot input keyboard or mouse data. The button is shadowed when the KM is occupied. The icon displays next to the user's name in the User List panel when the user has occupied the KM.

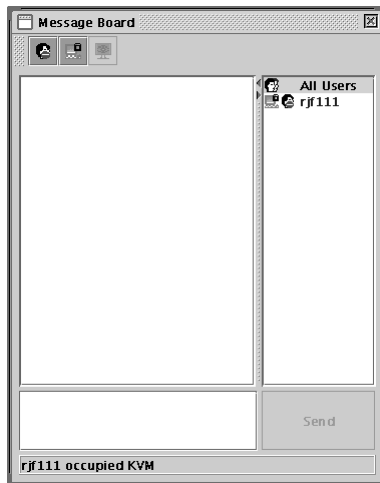

(Continues on next page.)

(Continued from previous page.)

- ◆ Messages that users post to the board - as well as system messages - display in the *Message Display* panel. If you disable Chat, however, messages that get posted to the board won't appear.
- ◆ Key in the messages that you want to post to the board in the *Compose* panel. Click **Send**, to post the message to the board.
- ◆ The names of all the logged in users appear in the *User List* panel.
 - ◆ By default, messages are posted to all users. To post a message to one individual user, select the user's name before sending your message.
 - ◆ If a user's name is selected, and you want to post a message to all users, select *All Users* before sending your message.
 - ◆ If a user has disabled Chat, its icon displays before the user's name to indicate so.
 - ◆ If a user has occupied the KVM or the KM, its icon displays before the user's name to indicate so.
 - ◆ To Hide/Unhide the *User List* panel, click on the arrows in the panel separator.



Lock Key LEDs and Resolution

These LEDs show the Num Lock, Caps Lock, and Scroll Lock status of the remote computer. They turn Green when the Lock status is **On**. Click on the icon to toggle the status.

Note: When you first connect, the LED display may not be accurate. To be sure, click on the LEDs to set them.

The video resolution of the device connected to the remote port displays directly below the Lock LEDs.



Switch Screen Mode

Clicking this button enables or disables Full Screen Mode. (By default the Java Client opens in Full Screen Mode.)



About

Clicking this button opens the About dialog box, which displays the Java Client Version information. Click the OK button to close the dialog box.



Send Ctrl+Alt+Del

Clicking this button sends a Ctrl+Alt+Del signal to the remote system.



Help

Clicking this button brings up the online help screen for the Java Client.



Exit

Clicking the Exit button terminates the Java Client session.

Port Operation

Java Client port operation is the same as for the Windows Client. See *Port Operation*, page 91, for details.

Keyboard Hotkey Operation

Keyboard hotkey operation is the same as for the Windows Client. See *Keyboard Hotkey Operation*, page 94, for details.

This Page Intentionally Left Blank

Chapter 8

The Log File

The Main Screen

The B020-008-17-IP logs all the events that take place on it. To view the contents of the log file, click the *Log* icon at the left of the Webpage. A screen similar to the one below appears:



A maximum of 512 events are stored in the log file. To clear the log file, click on the *Clear Log* icon at the lower right of the screen.

Note: The Log File is a temporary file that is erased when the B020-008-17-IP is turned off or loses power. It is recommended that you install the Log Server to backup the contents of the log file.

This Page Intentionally Left Blank

Chapter 9

The Log Server

The Windows-based Log Server is an administrative utility that records all the events that take place on selected B020-008-17-IP units and writes them to a searchable database. This chapter describes how to install and configure the Log Server.

Installation

1. From the computer that you want to use as the Log Server, open your browser and log into the B020-008-17-IP (see page 71).
2. Click the *Log Server* button at the left of the Webpage to start the Log Server installation program.
3. If any security warning dialog boxes appear, ignore them and click **Run** or **Open**.

Note: If the browser cannot run the file, save it to disk, instead, and run the file from your disk.

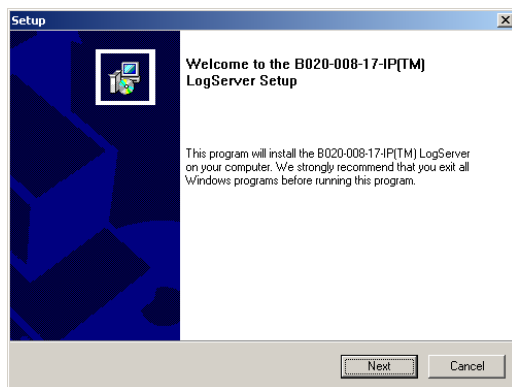

4. Click **Next**. Then follow the on-screen instructions to complete the installation and have the Log Server program icon placed on your desktop.

Starting Up

To bring up the Log Server, either double click the program icon, or key in the full path to the program on the command line. The first time you run it, a screen similar to the one below appears:

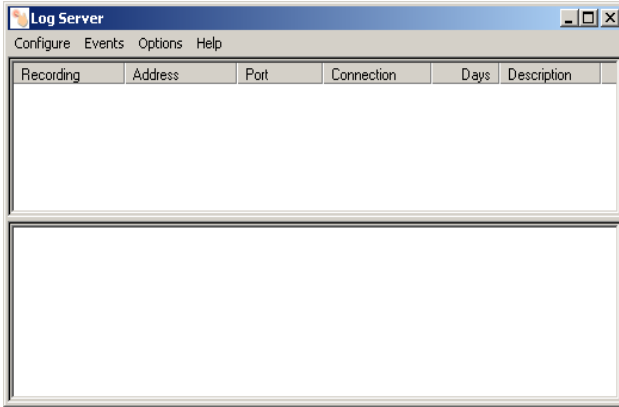

-
- Note:**
1. The MAC address of the Log Server computer must be specified on the *Service Configuration* page of the *Administrator Utility* (see page 55).
 2. The Log Server requires the Microsoft Jet OLEDB 4.0 driver in order to access the database.
-

The screen is divided into three components:

- ◆ A *Menu Bar* at the top
- ◆ A panel that will contain a list of B020-008-17-IP units in the middle (see *The Log Server Main Screen*, page 117, for details).
- ◆ A panel that will contain an *Events List* at the bottom

Each of the components is explained in the sections that follow.

The Menu Bar

The Menu bar consists of four items:

- ◆ Configure
- ◆ Events
- ◆ Options
- ◆ Help

These are discussed in the sections that follow.

Note: If the Menu Bar appears to be disabled, click in the B020-008-17-IP List window to enable it.

Configure

The Configure menu contains three items: Add, Edit, and Delete. They are used to add new B020-008-17-IP units to the B020-008-17-IP List, edit the information for units already on the list, or delete B020-008-17-IP units from the list.

- ◆ To add a B020-008-17-IP to the B020-008-17-IP List, click **Add**.
- ◆ To edit or delete a listed B020-008-17-IP, first select the one you want in the B020-008-17-IP List window, then open this menu and click **Edit** or **Delete**.

When you choose *Add* or *Edit*, a dialog box, similar to the one below appears:

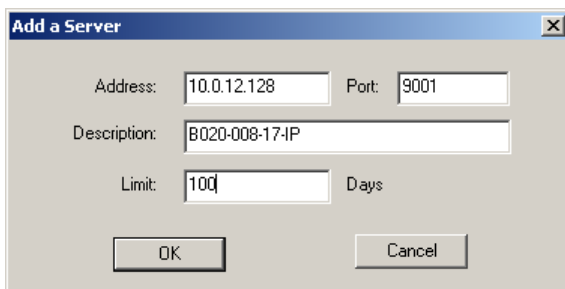

The screenshot shows a dialog box titled "Add a Server". It contains the following fields and values:

Address:	10.0.12.128	Port:	9001
Description:	B020-008-17-IP		
Limit:	100	Days	

At the bottom of the dialog are two buttons: "OK" and "Cancel".

A description of the fields is given in the table, below:

Field	Explanation
Address	This can either be the IP address of the B020-008-17-IP or its DNS name (if the network administrator has assigned it a DNS name).
Port	The port number that was assigned to the Log Server in the B020-008-17-IP OSD (see <i>Log Server</i> , page 56).
Description	This field is provided so that you can put in a descriptive reference for the unit to help identify it.
Limit	This specifies the number of days that an event should be kept in the Log Server's database before it expires and it is cleared out.

Fill in or modify the fields, then click **OK** to finish.

Events

The Events Menu has two items: *Search* and *Maintenance*.

Search

Search allows you to search for events containing specific words or strings. When you access this function, a screen similar to the one below appears:

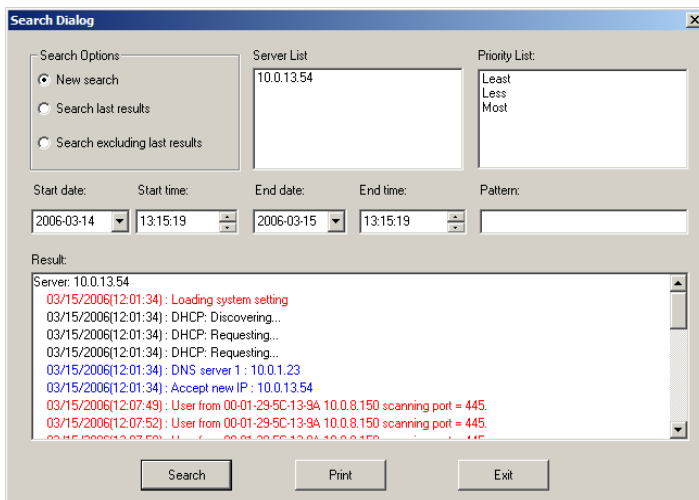

A description of the items is given in the table below:

Item	Explanation
New search	This is one of three radio buttons that define the scope of the search. If it is selected, the search is performed on all the events in the database for the selected B020-008-17-IP.
Search last results	This is a secondary search performed on the events that resulted from the last search.
Search excluding last results	This is a secondary search performed on all the events in the database for the selected B020-008-17-IP <i>excluding</i> the events that resulted from the last search.
Server List	B020-008-17-IP units are listed according to their IP address. Select the unit that you want to perform the search on from this list. You can select more than one unit for the search. If no units are selected, the search is performed on all of them.
Priority List	Sets the level for how detailed the search results display should be. 1 is the most general; 3 is the most specific.
Start Date	Select the date that you want the search to start from. The format follows the MM/DD/YYYY convention, as follows: 11/04/2005
Start Time	Select the time that you want the search to start from.
End Date	Select the date that you want the search to end at.
End Time	Select the time that you want the search to end at.
Pattern	Key in the pattern that you are searching for here. The multiple character wildcard (%) is supported. E.g., h%ds would match <i>hands</i> and <i>hoods</i> .
Results	Lists the events that contained matches for the search.
Search	Click this button to start the search.
Print	Click this button to print the search results.
Exit	Click this button to exit the Search dialog box.

Maintenance

This function allows the administrator to perform manual maintenance of the database, such as erasing specified records before the expiration time that was set with the *Limit* setting of the Edit function (see page 114).

Options

Network Retry allows you to set the number of seconds that the Log Server should wait before attempting to connect if the previous attempt to connect failed. When you click this item, a dialog box, similar to the one below appears:

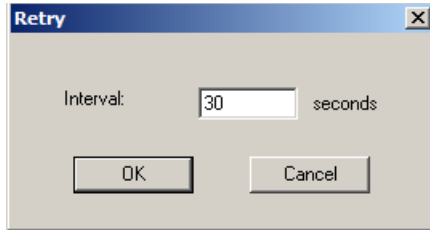

Key in the number of seconds, then click **OK** to finish.

Help

From the Help Menu, click Contents to access the online Windows Help file. The help file contains instructions about how to setup, operation and troubleshoot the Log Server.

The Log Server Main Screen

Overview

The Log Server Main Screen is divided into two main panels.

- ◆ The upper (List) panel lists the B020-008-17-IP units that have been selected for the Log Server to track (see *Configure*, page 113).
- ◆ The lower (Event) panel displays the log events for the currently selected B020-008-17-IP (the highlighted one - if there are more than one). To select a B020-008-17-IP unit in the list, simply click on it.

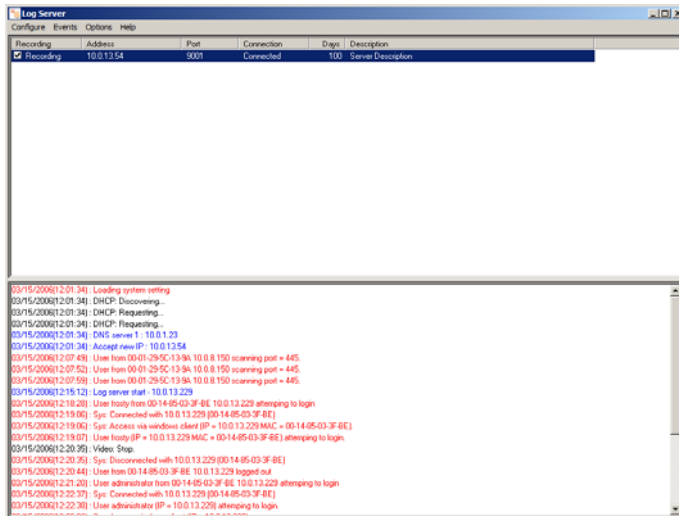

The List Panel

The List panel contains six fields:

Field	Explanation
Recording	Determines whether the Log Server records log events for this B020-008-17-IP or not. If the Recording check box is checked, the field displays <i>Recording</i> , and log events are recorded. If the Recording check box is not checked, the field displays <i>Paused</i> , and log events are not recorded. Note: Even though a B020-008-17-IP is not the currently selected one, if its Recording check box is checked, the Log Server will still record its log events.
Address	This is the IP Address or DNS name that was given to the B020-008-17-IP when it was added to the Log Server (see <i>Configure</i> , page 113).
Port	This is the port number that was assigned to the Log Server in the B020-008-17-IP OSD (see <i>Log Server</i> , page 56).
Connection	If the Log Server is connected to the B020-008-17-IP, this field displays <i>Connected</i> . If it is not connected, this field displays <i>Waiting</i> . This means that the Log Server's MAC address has not been set properly. It needs to be set on the <i>Service Configuration</i> page of the <i>Administrator Utility</i> (see page 55).
Days	This field displays the number of days that the B020-008-17-IP's log events are to be kept in the Log Server's database before expiration (see <i>Configure</i> , page 113).
Description	This field displays the descriptive information given for the B020-008-17-IP when it was added to the Log Server (see <i>Configure</i> , page 113).

The Tick Panel

The lower panel displays tick information for the currently selected B020-008-17-IP. Note that if the installation contains more than one switch, even though a switch isn't currently selected, if its *Recording* checkbox is checked, the Log Server records its tick information and keeps it in its database.

Chapter 10

AP Operation

Overview

In some cases, the Administrator may not want the B020-008-17-IP to be available via browser access. AP versions of the Windows Client and the Java Client are provided to enable direct access of the B020-008-17-IP without having to go through a browser.

The programs are initially downloaded from the browser page. After they have been downloaded by the Users, the Administrator can disable browser access (see page 63).

The Windows Client

Installation

To install the Windows Client on your computer, do the following:

1. Log into the B020-008-17-IP with your browser, and click the second *Windows Client* button (the one with the arrow). A screen similar to the one below appears:

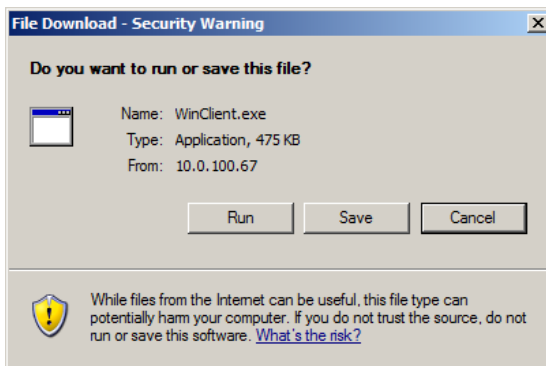

2. Click **Save**. In the dialog box that comes up specify a location on your hard disk to save it to.

Starting Up

To connect to the B020-008-17-IP, go to the location on your hard disk that you saved the Windows Client program to, and double-click its icon (WinClient.exe) to bring up the Windows Client Connection Screen:

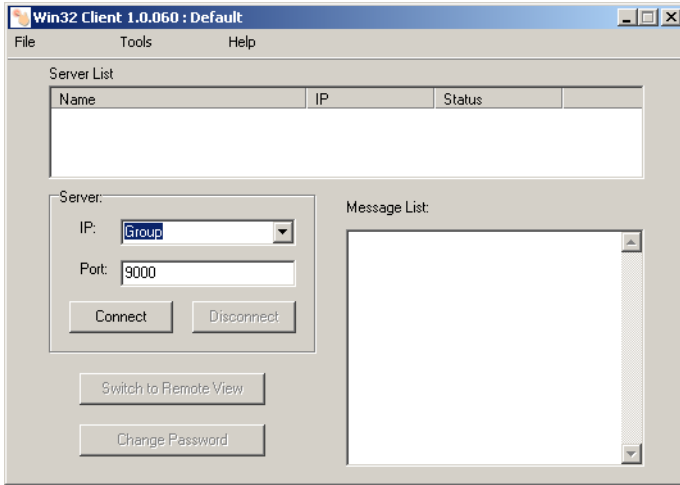

Note: You must have DirectX 7.0 or higher installed on your computer. If not, the Client program will not load.

(Continues on next page.)

(Continued from previous page.)

A description of the Connection Screen is given in the following table:

Menu Bar	<p>The Menu Bar contains three items: File, Tools, and Help.</p> <ul style="list-style-type: none"> ◆ The <i>File Menu</i> allows the operator to Create, Save, and Open user created Work files (see page 122 for details). ◆ The <i>Tools Menu</i> contains two entries: <i>Keyboard</i> and <i>Config</i>, (see page 122 for details).
Server List	<p>Each time the WinClient.exe file is run, it searches the User's local LAN segment for B020-008-17-IP units, and lists whichever ones it finds in this box. If you want to connect to one of these units, double-click it.</p>
Server	<p>This area is used when you want to connect to a B020-008-17-IP at a remote location. You can drop down the <i>IP</i> list box and select an address from the list. If the address you want isn't listed, you can key in the IP address you want. Then, key in the Port number in the <i>Port</i> field. If you don't know the Port number, then contact the Administrator.</p> <p>When the IP address and Port number for the unit you wish to connect to have been specified, Click Connect to start the connection. When you have finished with your session, Click Disconnect to end the connection.</p>
Message List	<p>Lists status messages regarding the connection to the B020-008-17-IP.</p>
Switch to Remote View	<p>Once contact with a B020-008-17-IP has been established, this button becomes active. Click it to switch and take over console control of the unit that is attached to the B020-008-17-IP.</p> <p>The screen output of the unit appears on your monitor. Your keystrokes and mouse movements are captured and sent to the B020-008-17-IP to be executed on the attached unit.</p> <p>If the B020-008-17-IP is connected to a KVM switch, you can control the switch and the computers connected to it just as if you were connected locally.</p>
Change Password	<p>This button becomes active after a connection to a B020-008-17-IP unit has been established. It allows the User to change the password used to log in to the B020-008-17-IP.</p>

The File Menu

The *File Menu* allows the operator to Create, Save, and Open user created Work files. A Work File consists of all the information specified in a Client session. This includes the Server List and Server IP list items, as well as the Hotkey settings.

Whenever a user runs the Client program, it opens with the values contained in the *current work file*. The current work file consists of the values that were in effect the last time the program was closed.

The File menu consists of three items, as follows:

New	Allows the user to create a named work file so its values will not be lost, and it will be available for future recall.
Open	Allows the user to open a previously saved work file and use the values contained in it.
Save	Allows the user to save the values presently in effect as the <i>current work file</i> .

The Tools Menu

Tools menu operations are performed after you connect, but before you switch to remote view. There are two entries on the Tools Menu: Keyboard and Config. They are explained in the sections that follow.

Keyboard

Various configuration actions related to the keyboard, video, and mouse can be performed via hotkey combinations. The Hotkey Setup utility is accessed by opening the *Tools* menu and selecting *Keyboard*. The Hotkey Setup Screen that appears is essentially the same dialog box discussed in the browser-based *Windows Client* chapter. See *Hotkey Setup*, page 82 for details.

Config

When you select *Config*, a screen similar to the one below appears:

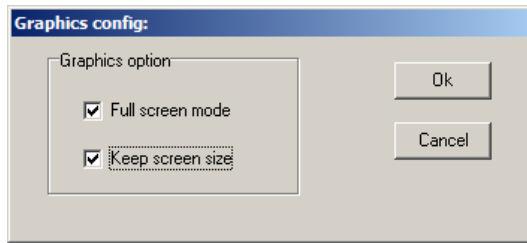

- ◆ If *Full Screen Mode* is enabled (there is a checkmark in the box), the remote display fills the entire screen of your local monitor.
- ◆ If *Full Screen Mode* is not enabled (there is no checkmark in the box), the remote display appears as a window on your desktop. If the remote screen is larger than what is able to fit in the window, move the mouse pointer to the screen border that is closest to the area you want to view and the screen will scroll.
- ◆ If *Keep Screen Size* is enabled (there is a checkmark in the box), the remote screen is not resized.
 - ◆ If the remote resolution is smaller, its display appears as a window centered on your screen.
 - ◆ If the remote resolution is larger, its display is centered on your screen. To access the areas that are off screen, move the mouse to the corner of the screen that is closest to the area you want to view and the screen will scroll.
- ◆ If *Keep Screen Size* is not enabled (there is no checkmark in the box), the remote screen is resized to fit the resolution of your local monitor.

Connecting

To connect to a B020-008-17-IP unit:

1. From the *Server List* box, **double-click** the device that you wish to connect to. Or, specify the IP address and port number in the *Server IP* and *Port* input boxes, and then Click **Connect**. The *Login* dialog box appears:

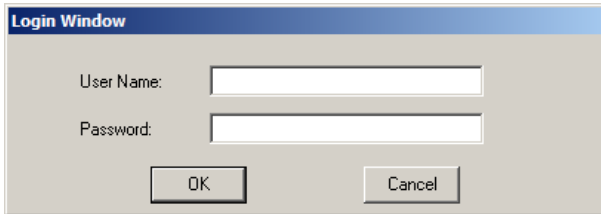

The image shows a dialog box titled "Login Window". It has a blue header bar. Below the header, there are two text input fields. The first is labeled "User Name:" and the second is labeled "Password:". Below these fields are two buttons: "OK" and "Cancel".

2. Key in a valid Username and Password, and then click **OK**.
The program attempts to connect to the selected B020-008-17-IP unit. While it does so, you can check the *Message List* window for status messages regarding the operation's progress.
3. Once contact with the B020-008-17-IP has been established, the *Switch to Remote View* button becomes active. Click it to connect to the B020-008-17-IP and take over console control of the unit that is connected to it.

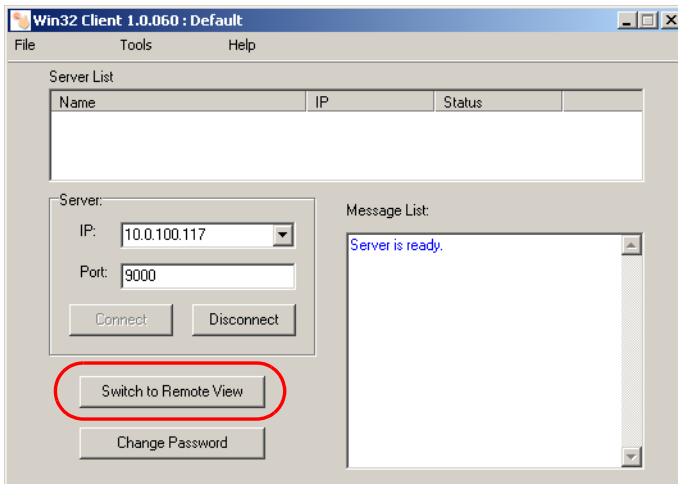

Operation

Once a connection to the B020-008-17-IP has been established, the remote system's video output is captured and displayed on your monitor. At the same time, your local keystroke and mouse input is captured and sent to the remote system.

The look and feel of the AP Windows client operation is the same as for the browser version of the Windows client. Refer back to page 77 for details.

Ending the Session

After you log out of the B020-008-17-IP, you return to the Connection dialog box. Click **Disconnect** to end the session.

The Java Client

Installation

To install the Java Client on your computer, do the following:

1. Log into the B020-008-17-IP with your browser, and click the second *Java Client* button (the one with the arrow). A screen similar to the one below appears:

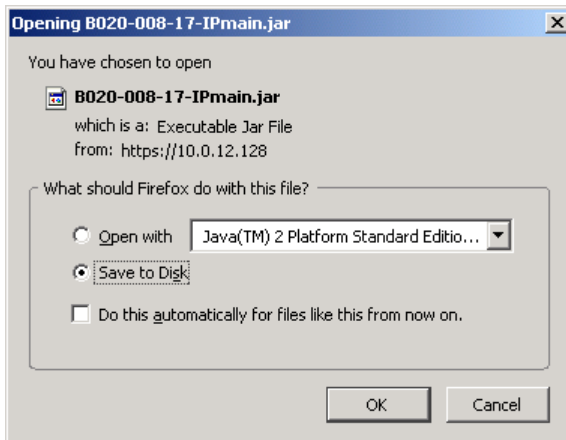

2. Click **Save**. In the dialog box that comes up specify a location on your hard disk to save it to.

Starting Up

To connect to the B020-008-17-IP do the following:

1. Open a command line window and change to the directory where the Java Client file (B020-008-17-IPmain.jar) is at.
2. From the command line, issue the following command:

```
java - jar B020-008-17-IPmain.jar
```

Note: You must install Java version 1.4.2 or higher before running the Java Client. It will not work with earlier versions of Java.

(continues on next page)

(Continued from previous page.)

The *Address Input* dialog box appears:



3. Key in the IP address for the unit you want to connect to - including a forward slash followed by the login string.

Note: For security purposes, the login string (set by the administrator), must be specified correctly as part of the IP address. The system administrator may change the string from time to time to thwart unauthorized access attempts. Be sure you have the correct string when you attempt to connect.

After you establish a connection, a Login dialog box appears:



4. Provide a valid Username and Password, and then click **OK**.

Once the authentication procedure completes successfully, the B020-008-17-IP main page displays on your monitor.

Operation

The look and feel of the AP Java client operation is the same as for the browser version of the Java client. Refer back to Chapter 7, *Java Client Port Operation* for details.

Safety Instructions

General

- ◆ Read all of these instructions. Save them for future reference.
- ◆ Follow all warnings and instructions marked on the device.
- ◆ Do not place the device on any unstable surface (cart, stand, table, etc.). If the device falls, serious damage will result.
- ◆ Do not use the device near water.
- ◆ Do not place the device near, or over, radiators or heat registers.
- ◆ The device cabinet is provided with slots and openings to allow for adequate ventilation. To ensure reliable operation, and to protect against overheating, these openings must never be blocked or covered.
- ◆ The device should never be placed on a soft surface (bed, sofa, rug, etc.) as this will block its ventilation openings. Likewise, the device should not be placed in a built in enclosure unless adequate ventilation has been provided.
- ◆ Never spill liquid of any kind on the device.
- ◆ Unplug the device from the wall outlet before cleaning. Do not use liquid or aerosol cleaners. Use a damp cloth for cleaning.
- ◆ The device should be operated from the type of power source indicated on the marking label. If you are not sure of the type of power available, consult your dealer or local power company.
- ◆ The device is equipped with a 3-wire grounding type plug. This is a safety feature. If you are unable to insert the plug into the outlet, contact your electrician to replace your obsolete outlet. Do not attempt to defeat the purpose of the grounding-type plug. Always follow your local/national wiring codes.
- ◆ Do not allow anything to rest on the power cord or cables. Route the power cord and cables so that they cannot be stepped on or tripped over.
- ◆ If an extension cord is used with this device make sure that the total of the ampere ratings of all products used on this cord does not exceed the extension cord ampere rating. Make sure that the total of all products plugged into the wall outlet does not exceed 15 amperes.

- ◆ To help protect your system from sudden, transient increases and decreases in electrical power, use a Tripp Lite surge suppressor, line conditioner, or uninterruptible power supply (UPS).
- ◆ Position system cables and power cables carefully; Be sure that nothing rests on any cables.
- ◆ When connecting or disconnecting power to hot pluggable power supplies, observe the following guidelines:
- ◆ Install the power supply before connecting the power cable to the power supply.
- ◆ Unplug the power cable before removing the power supply.
- ◆ If the system has multiple sources of power, disconnect power from the system by unplugging all power cables from the power supplies.
- ◆ Never push objects of any kind into or through cabinet slots. They may touch dangerous voltage points or short out parts resulting in a risk of fire or electrical shock.
- ◆ Do not attempt to service the device yourself. Refer all servicing to qualified service personnel.
- ◆ If the following conditions occur, unplug the device from the wall outlet and bring it to qualified service personnel for repair.
 - ◆ The power cord or plug has become damaged or frayed.
 - ◆ Liquid has been spilled into the device.
 - ◆ The device has been exposed to rain or water.
 - ◆ The device has been dropped, or the cabinet has been damaged.
 - ◆ The device exhibits a distinct change in performance, indicating a need for service.
 - ◆ The device does not operate normally when the operating instructions are followed.
- ◆ Only adjust those controls that are covered in the operating instructions. Improper adjustment of other controls may result in damage that will require extensive work by a qualified technician to repair.

Rack Mounting

- ◆ Before working on the rack, make sure that the stabilizers are secured to the rack, extended to the floor, and that the full weight of the rack rests on the floor. Install front and side stabilizers on a single rack or front stabilizers for joined multiple racks before working on the rack.
- ◆ Always load the rack from the bottom up, and load the heaviest item in the rack first.
- ◆ Make sure that the rack is level and stable before extending a device from the rack.
- ◆ Use caution when pressing the device rail release latches and sliding a device into or out of a rack; the slide rails can pinch your fingers.
- ◆ After a device is inserted into the rack, carefully extend the rail into a locking position, and then slide the device into the rack.
- ◆ Do not overload the AC supply branch circuit that provides power to the rack. The total rack load should not exceed 80 percent of the branch circuit rating.
- ◆ Ensure that proper airflow is provided to devices in the rack.
- ◆ Do not step on or stand on any device when servicing other devices in a rack.

Specifications

Function		B020-008-17-IP	
Computer Connections	Direct	8	
	Max.	64 (via Cascade)	
Console Connections	Local	1	
	Remote	1	
Port Selection		OSD, Hotkey, Pushbutton	
Connectors	Console Port	Keyboard	1 x 6-pin Mini-DIN Female (Purple)
		Video	1 x HDB-15 Female (Blue)
		Mouse	1 x 6-pin Mini-DIN Female (Green)
	KVM Port		8 x SPHD-15 Female (Yellow)
	Power		1 x 3 Prong AC Socket
	External Mouse		1 x 6-pin Mini-DIN Female (Green)
	LAN		1 x RJ-45 Female (Black)
	Switches	Reset	1 x Semi-recessed Pushbutton
Power		1 x Rocker	
Port Selection		2 x Pushbutton	
LCD Power		1 x Pushbutton	
LCM Adjustment		4 x Pushbutton	
LEDs	On Line	8 (Green)	
	Selected	8 (Orange)	
	Power	1 (Blue)	
	Num Lock	1 (Green)	
	Caps Lock	1 (Green)	
	Scroll Lock	1 (Green)	
	Link	1 (Green)	
10/100 Mbps		1 (Orange/Green)	

(Continues on next page.)

(Continued from previous page.)

Function		B020-008-17-IP
Emulation	Keyboard/Mouse	PS/2
Video	17" LCD	1280 x 1024 @ 75 Hz; DDC2B
	Remote	1600 x 1200 @ 60 Hz; DDC2B
Scan Interval		1–255 Seconds
I/P Rating		100–240V AC, 50/60 Hz, 1A
Power Consumption		120V/31W; 230V/39W
Environment	Operating Temp.	0–50° C
	Storage Temp.	-20–60° C
	Humidity	0–80% RH, Non-condensing
Physical Properties	Housing	Metal
	Weight	17.10 kg
	Dimensions (L x W x H)	70.50 x 48.20 x 4.40 cm (19"/1U)

OSD Factory Default Settings

The factory default settings are as follows:

Setting	Default
OSD Hotkey	[Scroll Lock] [Scroll Lock]
Port ID Display	Port Number + Name
Port ID Display Duration	5 Seconds
Scan / Skip Mode	All
Scan Duration	10 Seconds
Screen Blanker	0 Minutes (disabled)
Beeper	On
Accessible Ports	F (Full) For all Users on all Ports

Trusted Certificates

Overview

When you try to login to the B020-008-17-IP from your Web browser, a Security Alert message appears to inform you that the device's certificate is not trusted, and asks if you want to proceed.



The certificate can be trusted, but the alert is triggered because the certificate's name is not found on Microsoft's list of Trusted Authorities. You have two options: 1) you can ignore the warning and click **Yes** to go on; or 2) you can install the certificate and have it be recognized as trusted.

- ◆ If you are working on a computer at another location, accept the certificate for just this session by clicking **Yes**.
- ◆ If you are working at your own computer, install the certificate on your computer (see below for details). After the certificate is installed, it will be recognized as trusted.

Installing the Certificate

To install the certificate:

1. In the **Security Alert** dialog box, click **View Certificate**. The **Certificate** dialog box appears.

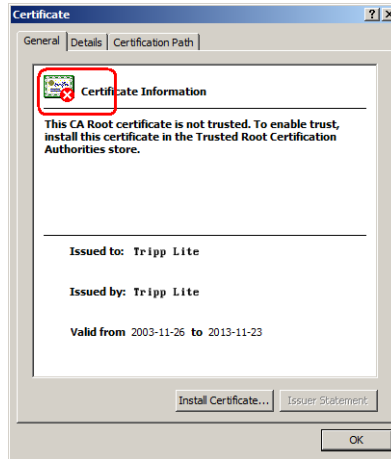

Note: There is a red and white **X** logo over the certificate to indicate that it is not trusted.

2. Click **Install Certificate**.
3. Follow the Installation Wizard to complete the installation. Unless you have a specific reason to choose otherwise, accept the default options. The Wizard presents a caution screen:

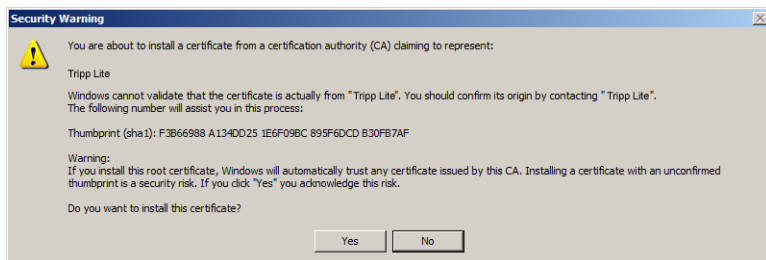

4. Click **Yes**.

5. Click **Finish** to complete the installation.
6. Click **OK** to close the dialog box.

Certificate Trusted

The certificate is now trusted:

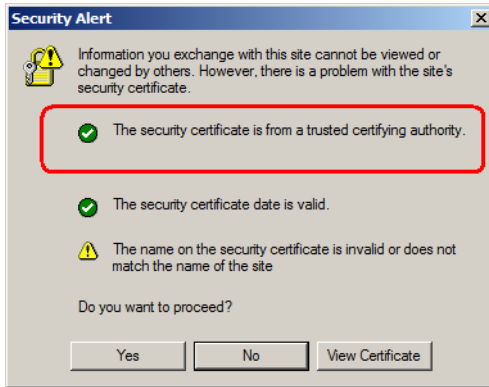

When you click **View Certificate**, you can see that the red and white **X** logo is no longer present – further indication that the certificate is trusted.

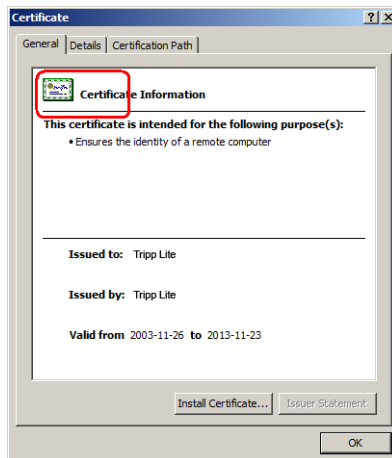

Troubleshooting

Administration

Symptom	Possible Cause	Action
After upgrading firmware, the B020-008-17-IP still appears to be using the old firmware version.	Your Web browser is displaying cached Webpages and has not fetched new versions of the B020-008-17-IP Webpages.	Delete all temporary Internet files and cookies, close the Web browser, and then open a new instance of the Web browser.
After making changes and checking <i>Reset on exit</i> and then logging out, the B020-008-17-IP doesn't reset after I exit.	You are using Windows 2000 Professional and IE 5 to log into the B020-008-17-IP.	Upgrade your browser to IE 6.0.2800.1106 or higher.
After making changes and checking <i>Reset on exit</i> , when I log back in the calendar changes to an incorrect (much earlier) date.	The B020-008-17-IP reverts to the firmware's release date when you <i>Reset on exit</i> .	Log in from a remote console to automatically recover the correct date. If you log in from the local console, go to the Administration page and reset the calendar to the correct date (see page 51 and page 67).

General Operation

Problem	Possible Cause	Solution
Erratic operation	The system needs to be reset.	Press and hold the <i>Reset</i> button (see page 21) for at least three seconds.
Mouse and/or keyboard not responding	Improper mouse and/or keyboard reset	Unplug the cable(s) from the console port(s), and then plug it back in again.
Sudden loss of network connection	Local reset of B020-008-17-IP	Close your B020-008-17-IP connection. Wait approximately 30 seconds, and then log in again.
When logging in from a browser, the following message appears: <i>404 Object Not Found</i> .	The <i>login string</i> was not included when the IP address was specified.	Make sure to include the forward slash and correct login string when you specify the B020-008-17-IP's IP address. (See <i>Default Webpage Name</i> , page 62.)
Two pointers appear when I login from a remote computer.	This is normal. One is the pointer of the computer that you are accessing; the other is the remote computer's pointer.	You can shrink the non-functioning pointer so that it is almost invisible. See <i>Toggle mouse display</i> , page 83, for details.
The OSD display is intermittent when accessing a computer for which the display refresh rate is set to 56Hz.	The refresh rate of the computer conflicts with that of the OSD.	Press [F6] to blank the background when using the OSD.
I can't set the computers' screen resolutions higher than 1280 x 1024, even though the B020-008-17-IP supports 1600 x 1200 for remote computers.	The maximum screen resolution of the B020-008-17-IP's integrated LCD monitor is 1280 x 1024. In order to protect it from being damaged by resolutions that are beyond its display capability, we recommend that the screen resolutions of the connected computers be set to 1280 x 1024 or lower.	If you wish to set the screen resolutions of the connected computers to something higher than 1280 x 1024, see <i>Screen Resolutions Higher than 1280 x 1024</i> , page 143.

(Continues on next page.)

(Continued from previous page.)

Symptom	Possible Cause	Action
<p>When I switch to one of the computers on my installation, the LCD monitor screen goes blank. All I see is a black screen.</p>	<p>The maximum screen resolution of the B020-008-17-IP's integrated LCD monitor is 1280 x 1024. The screen resolution of the problem computer is set to something that is too high for the B020-008-17-IP's LCD monitor to display.</p>	<p>To resolve the problem, connect an external KVM console (with a monitor capable of displaying the problem computer's screen resolution) to the B020-008-17-IP's external console ports. Use the external console to access the problem computer and reduce its resolution to 1280 x 1024.</p> <p>Note: Although the LCD monitor only supports video resolutions of up to 1280 x 1024, the B020-008-17-IP, itself can support video resolutions up to 1600 x 1200 @ 60 Hz. If you wish to set the screen resolutions of the connected computers to something higher than 1280 x 1024, see <i>Screen Resolutions Higher than 1280 x 1024</i>, page 143 for details.</p>
<p>When viewing a computer with a high screen resolution from a remote computer, I can't see the entire desktop.</p>	<p>The computer's screen resolution exceeds that of the remote computer, or Windows is emulating a higher screen resolution than the computer's graphics card supports.</p>	<p>Try to move the pointer up and down, and side to side to expose the parts of the desktop that you can't see. If this doesn't work, toggling the mouse display will allow you to use the computer's own pointer to view the rest of the desktop. See <i>Toggle mouse display</i>, page 83.</p>

The Java Client

For mouse synchronization problems, see *The Message Board Button Bar*, page 104, and *Additional Mouse Synchronization Procedures*, page 145. For connection and operation problems, see the table below:

Problem	Resolution
Java Client won't connect to the B020-008-17-IP.	<ol style="list-style-type: none"> 1. Java 2 JRE 1.4.2 or higher must be installed on your computer. 2. Make sure to include the forward slash and <i>login string</i> (see <i>Default Webpage Name</i>, page 62) when you specify the B020-008-17-IP's IP address. 3. Close the Java Client, reopen it, and try again.
Pressing the Windows Menu key has no effect.	Java doesn't support the Windows Menu key.
Java Client performance deteriorates.	Exit the program and start again.
National language characters do not appear.	If the local keyboard is set to a non-English layout, you must set the remote computer's keyboard layout to English.
IP and MAC address filters do not work with the Java Client.	IP and MAC address filters only work with the Windows Client. We recommend using the <i>Default Web page name</i> (see page 61) as a means to enhance the overall security of the KVM switch.

The Log Server

Problem	Resolution
The Log Server program does not run.	<p>The Log Server requires a file provided by Microsoft in order to access the database.</p> <p>This file is automatically installed with Windows ME, 2000, and XP.</p> <p>For Windows 98 and NT you will have to go to the Microsoft download site:</p> <p>http://www.microsoft.com/data/download.htm to retrieve the file:</p> <p>MDAC 2.7 RTM - Refresh (2.70.9001.0)</p> <p>Since this driver is used in Windows Office Suite, an alternate method of obtaining it is to install Windows Office Suite. Once the driver file or Suite has been installed, the Log Server will run.</p>

Panel Array Mode

Problem	Resolution
Low resolution video in Panel Array Mode.	Increase the number of panels that are displayed.
When multiple remote users are logged in concurrently, some of them only receive a partial image.	The first user to invoke Panel Array Mode should set it to display at least 4 panels.

The Windows Client

Problem	Resolution
The Windows Client won't connect to the B020-008-17-IP.	DirectX 7.0 or higher must be installed on the remote computer.
The remote computer's pointer is out of sync.	<ol style="list-style-type: none"> 1. Use the <i>AutoSync</i> feature (see <i>Video Adjustment</i>, page 84), to sync the local and remote monitors. 2. If that doesn't resolve the problem, use the <i>Adjust Mouse</i> feature (see <i>Adjust mouse</i>, page 83) to bring them back in sync. 3. If the two methods described above fail to resolve the problem, use the <i>Toggle Mouse Display</i> function (see page 83). 4. See <i>Additional Mouse Synchronization Procedures</i>, page 145.
Part of the remote window is off my monitor.	<ol style="list-style-type: none"> 1. If <i>Keep Screen Size</i> (see page 123) is not enabled, use the <i>AutoSync</i> feature (see <i>Video Adjustment</i>, page 84) to synchronize the local and remote monitors. 2. If <i>Keep Screen Size</i> is enabled, you can scroll to the areas that are off the screen. See the note on page 78 for details.
The remote computer's display is rotated 90 degrees.	Enable <i>Keep Screen Size</i> (see page 123).
I cannot run <i>Net Meeting</i> when the Windows Client is running.	Enable <i>Keep Screen Size</i> (see page 123).
When I log in, the browser generates a <i>CA Root certificate is not trusted</i> , or a <i>Certificate Error</i> response.	The certificate's name is not found on Microsoft's list of Trusted Authorities. However, the certificate can be trusted. See <i>Trusted Certificates</i> , page 134, for details.

Sun Systems

Problem	Resolution
Video display problems with HDB-15 interface systems (e.g. Sun Blade 1000 servers).	<p>The display resolution should be set to 1024 x 768 @ 60Hz.</p> <p>Under Text Mode:</p> <ol style="list-style-type: none"> 1. Enter the <code>ok</code> prompt and issue the following firmware commands: <pre>setenv output-device screen:r1024x768x60 reset-all</pre> <p>Under XWindow:</p> <ol style="list-style-type: none"> 1. Open a console and issue the following command: <pre>m64config -res 1024x768x60</pre> 2. Log out. 3. Log in.
Video display problems with 13W3 interface systems (e.g. Sun Ultra servers).*	<p>The display resolution should be set to 1024 x 768 @ 60Hz.</p> <p>Under Text Mode:</p> <ol style="list-style-type: none"> 1. Enter the <code>ok</code> prompt and issue the following firmware commands: <pre>setenv output-device screen:r1024x768x60 reset-all</pre> <p>Under XWindow:</p> <ol style="list-style-type: none"> 1. Open a console and issue the following command: <pre>ffbconfig -res 1024x768x60</pre> 2. Log out. 3. Log in.

* These solutions work for most common Sun VGA cards. If using them fails to resolve the problem, consult the Sun VGA card's manual.

Screen Resolutions Higher than 1280 x 1024

The maximum screen resolution of the B020-008-17-IP's integrated LCD monitor is 1280 x 1024. In order to protect it from being damaged by resolutions that are beyond its display capability, we recommend that the screen resolutions of the connected computers be set to 1280 x 1024 or lower.

If you wish to display screen resolutions higher than 1280 x 1024, follow the procedure described below to change the computers' screen resolutions and safeguard the B020-008-17-IP's LCD monitor:

Note: We strongly recommend that you close the B020-008-17-IP LCD console before continuing (see *Closing the Console*, page 35.) Using the LCD monitor to view computers that are set to resolutions that exceed its maximum capability can damage it and shorten its life span.

To access computers from the local console when the integrated console is closed, simply connect an external KVM console with a monitor that supports 1600 x 1200 @ 60 Hz to the B020-008-17-IP's external console ports.

1. From a remote computer, log into the B020-008-17-IP and access the computer whose screen resolution you wish to change.
2. Open the computer's *Control Panel* and double-click **Display**. The *Display Properties* dialog box appears.
3. Click the **Settings** tab, and then click **Advanced**.
4. In the dialog box that appears, click the **Monitor** tab.
5. Under *Monitor settings*, click to clear the *Hide modes that this monitor cannot display* check box.
6. Click **Apply**.
7. Click the **Adapter** tab, and then click **List All Modes**. The *List All Modes* dialog box appears.
8. Under *List of valid modes*, select the display mode that you want the computer to use.

Note: The maximum screen resolution and refresh rate that the B020-008-17-IP supports for remote computers is 1600 x 1200@60 Hz.

9. Click **OK**, and then click **Apply**. The display mode changes to the one you selected.

10. If the *Monitor Settings* dialog box appears requesting you to confirm the settings change, click **Yes**.

11. After the Monitor Settings dialog box closes, click **OK**.

12. In the Display Properties dialog box, click **OK**.

This completes the procedure. Repeat these steps for any other computer whose screen resolution you wish to change.

Additional Mouse Synchronization Procedures

If the mouse synchronization procedures mentioned in the manual fail to resolve mouse pointer problems for particular computers, try the following:

- Note:** 1. These procedures are to be performed on the computers attached to the B020-008-17-IP's ports - not on the computer you are using to access the B020-008-17-IP.
2. In order for the local and remote mice to synchronize, you must use the generic mouse driver supplied with the Windows operating system. If you have a third party driver installed - such as one supplied by the mouse manufacturer - you must remove it.

Windows 2000:

Set the mouse speed to the middle position; set the mouse acceleration to *None* (Control Panel → Mouse → Mouse Properties → Motion):

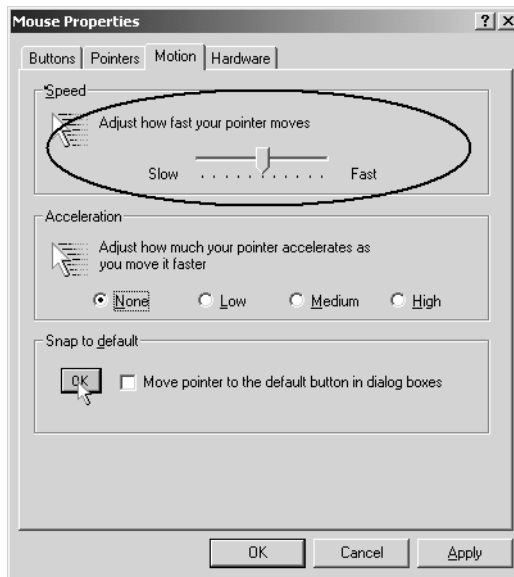

Windows XP / Windows Server 2003:

Set the mouse speed to the middle position; disable *Enhance Pointer Precision* (Control Panel → Printers and Other Hardware → Mouse → Pointer Options):

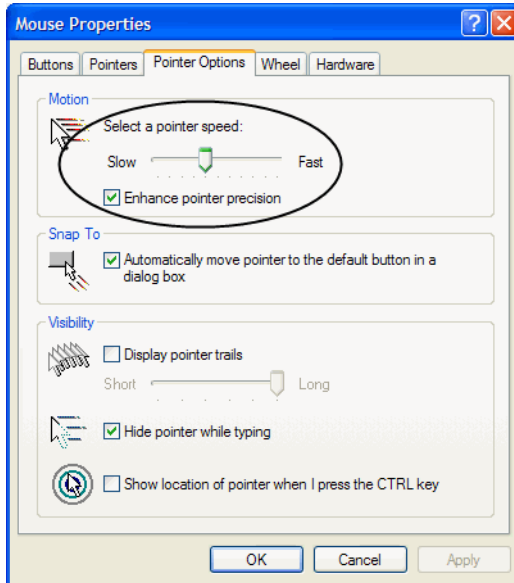
**Windows ME / Windows 95:**

Set the mouse speed to the middle position; disable mouse acceleration (click Advanced to get the dialog box for this).

Windows NT / Windows 98:

Set the mouse speed to the slowest position.

Sun / Linux:

Open a terminal session and issue the following command:

Sun: `xset m 1`

Linux: `xset m 0`

Administrator Login Failure

If you are unable to perform an Administrator login (because the Username and Password information has become corrupted, or you have forgotten it, for example), there is a procedure you can use to clear the login information.

Note: Performing this procedure also returns all settings to their defaults.

To clear the login information (and return all settings to their defaults), do the following:

1. Power off the B020-008-17-IP and remove the power cord from the power socket.
2. Remove the cover from the B020-008-17-IP.
3. Using a jumper cap, short the jumper labeled J18 on the mainboard.

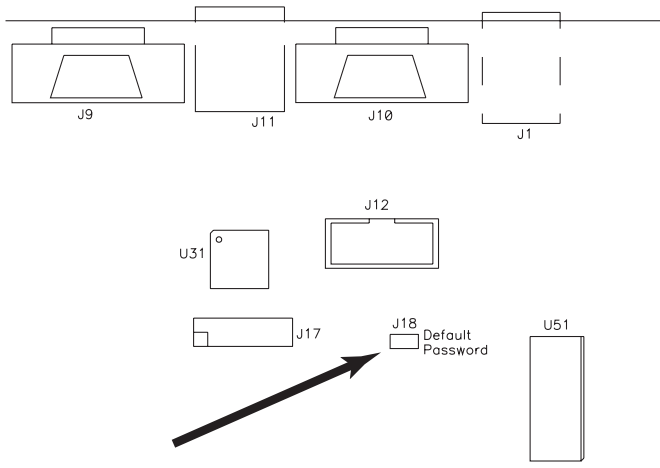

4. Replace the power cord and power on the B020-008-17-IP.
5. When the front panel LEDs flash, power off the B020-008-17-IP and remove the power cord from the power socket again.
6. Remove the jumper cap from the jumper.
7. Replace the cover on the switch. Replace the power cord and power on the KVM switch.
8. After powering on the unit, you can use the default Username and Password (see page 41) to log in.

Dedicated Invocation Keys

Two dedicated keys (below) are provided on the keyboard module to make it easy to invoke the OSD and the OSD Toolbar:

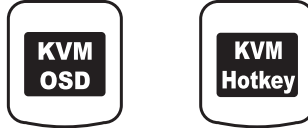

Note: These keys are toggles. Press once to invoke the feature, press again to exit.

- ◆ The KVM OSD Key invokes the OSD See *The Local Console*, page 41, for details.
- ◆ The KVM Hotkey Key opens the OSD Toolbar, which allows you to control the B020-008-17-IP from within the captured port. See *The OSD Toolbar*, page 91, for details.

About SPHD Connectors



This product uses SPHD connectors for its KVM and/or Console ports. We have specifically modified the shape of these connectors so that only KVM cables that we have designed to work with this product can be connected.

Supported KVM Switches

The following is a list of supported KVM switches that can be cascaded from the B020-008-17-IP.

- ◆ B007-008

Note: The B020-008-17-IP OSD port list does not display ports on cascaded KVM switches. After accessing a cascaded switch, invoke its OSD to manage its ports.

Limited Warranty

TRIPP LITE warrants its products to be free from defects in materials and workmanship for a period of one (1) year from the date of initial purchase. TRIPP LITE's obligation under this warranty is limited to repairing or replacing (at its sole option) any such defective products. To obtain service under this warranty, you must obtain a Returned Material Authorization (RMA) number from TRIPP LITE or an authorized TRIPP LITE service center. Products must be returned to TRIPP LITE or an authorized TRIPP LITE service center with transportation charges prepaid and must be accompanied by a brief description of the problem encountered and proof of date and place of purchase. This warranty does not apply to equipment which has been damaged by accident, negligence or misapplication or has been altered or modified in any way.

EXCEPT AS PROVIDED HEREIN, TRIPP LITE MAKES NO WARRANTIES, EXPRESS OR IMPLIED, INCLUDING WARRANTIES OF MERCHANTABILITY AND FITNESS FOR A PARTICULAR PURPOSE. Some states do not permit limitation or exclusion of implied warranties; therefore, the aforesaid limitation(s) or exclusion(s) may not apply to the purchaser.

EXCEPT AS PROVIDED ABOVE, IN NO EVENT WILL TRIPP LITE BE LIABLE FOR DIRECT, INDIRECT, SPECIAL, INCIDENTAL OR CONSEQUENTIAL DAMAGES ARISING OUT OF THE USE OF THIS PRODUCT, EVEN IF ADVISED OF THE POSSIBILITY OF SUCH DAMAGE. Specifically, TRIPP LITE is not liable for any costs, such as lost profits or revenue, loss of equipment, loss of use of equipment, loss of software, loss of data, costs of substitutes, claims by third parties, or otherwise.

WARRANTY REGISTRATION

Visit www.tripplite.com/warranty today to register the warranty for your new Tripp Lite product.

A

- Adjust Video
 - Java Client, 101
 - Windows Client, 84
- Administration, 41
- Administration Page, 51
 - Customization, 63
 - Date/Time, 67
 - General, 51
 - Network, 56
 - Security, 61
 - Service Configuration, 55
 - User Management, 52
- Administrator Login Failure, 147
- AP Operation
 - Config, 123
 - Java Client, 126
 - Windows Client, 119
- Auto Scanning, 94
 - Invoking Auto Scan, 94
 - Multuser Operation, 93
 - Pausing Auto Scan, 95
 - Scan Duration, 50
 - Setting the Scan Interval, 94

B

- B020-008-17-IP
 - Front View, 20
 - Rear View, 23
- Basic Operation, 31
- Beeper, 50
- Browser
 - General Dialog Box, 74
 - Logging In, 71
 - Operation, 71

C

- Clear Name List, 66
- Closing the Console, 35
- Configuration Page
 - Local Console, 49
- Console
 - Closing, 35
 - Opening, 31
 - Opening Together, 33
 - Separate Opening, 31
- Control Panel
 - Java Client, 101
 - Windows Client, 81
- Corrupt Password, 147
- Customization Settings, 63

D

- Date/Time Settings, 67
- Synchronize, 73

F

- Factory Default Settings, 133
- Features, 15
- Firmware, Upgrading, 69, 73
- Forgotten Password, 147
- Front View, 20

G

- Gamma adjustment, 86

H

- Hot Plugging, 39
- Hotkey
 - OSD, 50
- Hotkey operation
 - Auto Scanning, 94

- keyboard, 94, 107
- Hotkey setup, 82
- Hotkeys
 - Windows Client, 82, 122

I

- Installation
 - Cascading, 30
 - Single Stage, 28
- Invalid login, 72, 78
- IP Address, 74
 - Configuring, 56

J

- Java Client, 14, 126
 - Activating the OSD, 99
 - AP Installation, 126
 - AP Login, 127
 - AP Operation, 128
 - Control Panel, 101
 - Keypad, 102
 - Lock Key LEDs, 106
 - Troubleshooting, 140
 - Video Adjustment, 101
- Java client, 99

K

- Keyboard hotkey operation, 94, 107

L

- LCD OSD
 - Adjustment Settings, 38
 - Buttons, 37
 - Configuration, 37
- List Function, 44
- Local Console, 41
 - Administration Page, 51
 - Configuration Page, 49
 - Log Page, 68

- Main Page, 42
- Lock Key LEDs, 81, 106
- Log File, 109
- Log Page, 68
- Log Server
 - B020-008-17-IP Main Screen, 117
 - Configure, 113
 - Events, 114
 - Installation, 111
 - Main Screen, 112
 - Maintenance, 115
 - Menu Bar, 113
 - Options, 116
 - Search, 114
 - Settings, 56
 - Starting Up, 112
 - Tick Panel, 118
- Logging In, 71
- Logging Out, 73
- Login
 - Failure, 63
 - Invalid login, 72, 78

M

- Main Page
 - Local Console, 42
 - Windows Client, 80, 90, 100
- Main Webpage, 72, 79
- Message Board, 103
 - Java Client, 103
 - Windows Client, 87
- Mouse Synchronization, 97
- Mouse synchronization, 102
- Multuser Operation, 64, 93

N

- Naming ports, 46
- Network Settings, 56

O

- Opening the Console, 31
- Operating Precautions, 34
- Operation
 - AP, 119
- OSD
 - Activating in Windows, 77
 - Administration Page, 51
 - Configuration Page, 49
 - Factory Default Settings, 133
 - Hotkey, 50
 - Java, 99
 - Java client, 100
 - Log Page, 68
 - Main Page, 42, 90
 - Toolbar, 91
 - Windows client, 80
- Overview, 13

P

- Panel Array Mode
 - Multuser Operation, 93
- Port ID
 - Display Mode, 50
 - Numbering, 39
- Port Names, 46
- Port names, 46
- Port Operation
 - Windows client, 77
- Port operation
 - Java, 99
 - Java Client, 107
 - Windows Client, 91
- Port Selection, 39
 - Manual, 39
- Powering Off and Restarting, 39

Q

- Quick View Ports, 43

R

- Rack mounting
 - Standard, 26
- RADIUS, 58
 - Access Rights Examples, 60
 - Access Rights Table, 59
- Rear View, 23
- refresh screen, 85
- Requirements
 - OS Support, 19
- Reset on exit, 66, 74
- Reset Values, 66
- RoHS, 2

S

- Safety Instructions
 - General, 129
 - Rack Mounting, 131
- Save Settings
 - Reset on exit, 66
- Scan
 - Duration, 50
 - Select, 50
- Screen Blanker, 50
- screen, refresh, 85
- Security Settings, 61
- Setting the Auto Scan Interval, 94
- Share mode, 65
- Skip Mode, 95
- Specifications, 132
- Stealth Mode, 64
- Substitute keys, 96
- System Requirements, 17
 - Computer, 17
 - Console, 17

T

- Tick Panel, 118
- Toolbar

OSD, 91

Troubleshooting

Administration, 137

General operation, 138

Java Client, 140

Log Server, 140

Login Failure, 147

Panel Array Mode, 141

Sun Systems, 142

Windows Client, 141

Trusted Certificates, 134

U

Upgrading the Firmware, 69

User Management, 52

User Notice, 3

V

Video Adjustment

Java Client, 101

Windows Client, 84

W

Webpage

Buttons, 75

Icons, 73

Layout, 73

Windows Client, 14

Activating the OSD, 77

AP Config, 123

AP File Menu, 122

AP Installation, 119

AP Login, 124

AP Operation, 125

AP Tools Menu, 122

Control Panel, 81

Hotkeys, 122

Message Board, 87

OSD Toolbar, 91

Troubleshooting, 141

Video Adjustment, 84

Contents

FCC Information	2
User Information	3
User Notice	3
Package Contents	4
About This Manual	10
Overview	10
Conventions	11
Product Information	11
Chapter 1.	
Introduction	
Overview	13
Features	15
Requirements	17
External Console	17
Computers	17
Remote Computers	17
Cables	18
Converters and Adapters	18
Operating Systems	19
Components	20
Front View	20
Keyboard Module	21
LCD Module	22
Rear View	23
Chapter 2.	
Hardware Setup	
Before You Begin	25
Standard Rack Mounting	26
Single-Stage Installation	28
Two Stage Installation	30
Chapter 3.	
Basic Operation	
Opening the Console	31
Opening Separately	31
Opening Together	33
Operating Precautions	34
Closing the Console	35
LCD OSD Configuration	37
The LCD Buttons	37
The Adjustment Settings	38
Port Selection	39

Manual Port Switching	39
Hot Plugging	39
Powering Off and Restarting.	39
Port ID Numbering	39

Chapter 4.

Administration

Overview	41
The Local Console	41
The Main Page	42
Quick View Ports.	43
The List Function.	44
Port Names	46
Port Operation	48
The Configuration Page	49
The Administration Page	51
General	51
User Management.	52
Service Configuration	55
Network	56
ANMS	58
Security	61
Customization	63
Date/Time	67
The Log Page	68
Upgrading the Firmware	69

Chapter 5.

Browser Operation

Overview	71
Logging In	71
Webpage Layout.	73
Webpage Icons	73
The General Dialog Box	74
Webpage Buttons	75

Chapter 6.

Windows Client Port Operation

Activating the OSD	77
The Windows Client OSD.	80
Windows Client Control Panel	81
Hotkey Setup.	82
Video Adjustment	84
The Message Board	87
The Main Page	90
Port Operation	91

The OSD Toolbar	91
Recalling the OSD	91
OSD Hotkey Summary Table	92
OSD Toolbar Icons	92
Multiuser Operation	93
Keyboard Hotkey Operation	94
Auto Scanning	94
Setting the Scan Interval	94
Invoking Auto Scan	94
Pausing Auto Scan	95
Exiting Auto Scan	95
Skip Mode	95
Keyboard and Mouse Considerations	96
Keystrokes	96
Mouse Synchronization	97

Chapter 7.

Java Client Port Operation

Activating the OSD	99
The Java Client OSD	100
The Java Client Control Panel	101
Set Video Parameters	101
Keypad	102
Mouse Synchronization	102
Message Board	103
Lock Key LEDs and Resolution	106
Switch Screen Mode	106
About	106
Send Ctrl+Alt+Del	106
Help	106
Exit	106
Port Operation	107
Keyboard Hotkey Operation	107

Chapter 8.

The Log File

The Main Screen	109
-----------------------	-----

Chapter 9.

The Log Server

Installation	111
Starting Up	112
The Menu Bar	113
Configure	113
Events	114
Options	116

Help	116
The Log Server Main Screen	117
Overview	117
The List Panel	118
The Tick Panel	118

Chapter 10.

AP Operation

Overview	119
The Windows Client	119
Installation	119
Starting Up	120
The File Menu	122
The Tools Menu	122
Connecting	124
Operation	125
Ending the Session	125
The Java Client	126
Installation	126
Starting Up	126
Operation	128

Appendix

Safety Instructions	129
General	129
Rack Mounting	131
Specifications	132
OSD Factory Default Settings	133
Trusted Certificates	134
Overview	134
Installing the Certificate	135
Certificate Trusted	136
Troubleshooting	137
Administration	137
General Operation	138
The Java Client	140
The Log Server	140
Panel Array Mode	141
The Windows Client	141
Sun Systems	142
Screen Resolutions Higher than 1280 x 1024	143
Additional Mouse Synchronization Procedures	145
Administrator Login Failure	147
Dedicated Invocation Keys	148
About SPHD Connectors	149
Supported KVM Switches	149

Limited Warranty..... 150

Free Manuals Download Website

<http://myh66.com>

<http://usermanuals.us>

<http://www.somanuals.com>

<http://www.4manuals.cc>

<http://www.manual-lib.com>

<http://www.404manual.com>

<http://www.luxmanual.com>

<http://aubethermostatmanual.com>

Golf course search by state

<http://golfingnear.com>

Email search by domain

<http://emailbydomain.com>

Auto manuals search

<http://auto.somanuals.com>

TV manuals search

<http://tv.somanuals.com>