

INSTALLATION MANUAL FOR TH MODELS - (HEATED CABINETS)



TABLE OF CONTENTS

- ▶ **Safety Information**
 - Safety Precautions* _____ 1
 - Proper Disposal* _____ 2
 - Connecting Electricity* _____ 3
 - Adapter Plugs* _____ 3

- ▶ **Installation / Operation Instructions**
 - Ownership* _____ 4
 - Required Tools* _____ 4
 - Uncrating & Locating* _____ 4
 - Installation of Leg/Castors* _____ 5
 - Leveling Cabinet* _____ 6
 - Installing Ventilation Cap* _____ 6
 - Humidification Procedure* _____ 7
 - Electrical Instructions* _____ 7
 - Sealing Cabinet to Floor* _____ 8
 - Start-up* _____ 9
 - Shelving Installation - Operation* _____ 9

- ▶ **Maintenance, Care & Cleaning**
 - Stainless Steel Equipment Care & Cleaning* – 10-11
 - Warranty (U.S.A. & CANADA ONLY!)* _____ 12

*Spanish, German, French and Dutch versions included.

CONGRATULATIONS!
You have just purchased the finest commercial heated cabinet available. You can expect many years of trouble-free operation.

TH MODELS - (HEATED CABINETS)

SAFETY INFORMATION

How to Maintain Your *TRUE*® Unit to Receive the Most Efficient and Successful Operation

You have selected one of the finest commercial heated cabinets made. It is manufactured under strict quality controls with only the best quality materials available. Your TRUE heated cabinet, when properly maintained, will give you many years of trouble-free service.

WARNING!

Use this appliance for its intended purpose as described in this Owner Manual.

SAFETY PRECAUTIONS

When using electrical appliances, basic safety precautions should be followed, including the following:

- This heated cabinet must be properly installed and located in accordance with the Installation Instructions before it is used.
- Do not allow children to climb, stand or hang on the shelves in the unit. They could damage the heated cabinet and seriously injure themselves.
- Do not store or use gasoline or other flammable vapors and liquids in the vicinity of this or any other appliance.
- Keep fingers out of the “pinch point” areas; clearances between the doors and cabinet are necessarily small; be careful closing doors when children are in the area.

NOTE: We strongly recommend that any servicing be performed by a qualified individual.

- Unplug the unit before cleaning and making repairs.
- Setting temperature controls to the 0 position does not remove power to the light circuit.

SAFETY INFORMATION

DANGER!
RISK OF CHILD ENTRAPMENT

PROPER DISPOSAL OF THE CABINET

Child entrapment and suffocation are not problems of the past. Junked or abandoned display cases are still dangerous... even if they will sit for “just a few days.” If you are getting rid of your old display case, please follow the instructions below to help prevent accidents. Depending on the country where the unit is located there will be officially approved ways of disposing of your used equipment.

Before You Throw Away Your Old Refrigerator or Freezer or Heated Cabinet:

- Take off the doors.
- Leave the shelves in place so that children may not easily climb inside.

SAFETY INFORMATION

WARNING!

HOW TO CONNECT ELECTRICITY

Do not, under any circumstances, cut or remove the third (ground) prong from the power cord. For personal safety, this appliance must be properly grounded.

The power cord of this appliance is equipped with a 3-prong (grounding) plug which mates with a standard 3-prong (grounding) wall outlet to minimize the possibility of electric shock hazard from this appliance.

Have the wall outlet and circuit checked by a qualified electrician to make sure the outlet is properly grounded.

If the outlet is a standard 2-prong outlet, it is your personal responsibility and obligation to have it replaced with the properly grounded 3-prong wall outlet.

The heated cabinet should always be plugged into it's own individual electrical circuit, which has a voltage rating that matches the rating plate.

This provides the best performance and also prevents overloading building wiring circuits which could cause a fire hazard from overheated wires.

Never unplug your cabinet by pulling on the power cord. Always grip plug firmly and pull straight out from the outlet.

Repair or replace immediately all power cords that have become frayed or otherwise damaged. Do not use a cord that shows cracks or abrasion damage along its length or at either end.

When removing the cabinet away from the wall, be careful not to roll over or damage the power cord.

USE OF EXTENSION CORDS / ADAPTER PLUGS

Do not use adapter plugs or extension leads as these can cause safety issues and early failure of electrical components. The use of adapters and extension cords will invalidate your warranty. NEVER USE AN EXTENSION CORD! NEVER USE AN ADAPTER PLUG!

WARNING

Power supply cord ground should not be removed!

NOTE

To reference wiring diagram - Remove lower rear grill.

Wiring diagram is positioned on the inside cabinet wall.

NEMA plugs
TRUE uses these types of plugs. If you do not have the right outlet have a certified electrician install the correct power source.

 115/60/1
NEMA-5-15R

 115/60/1
NEMA-5-20R

INSTALLATION / OPERATION INSTRUCTIONS

INSTALLATION / OPERATION INSTRUCTIONS

OWNERSHIP

To insure that your unit works properly from the first day, it must be installed properly. We highly recommend that your True unit is installed by your supplying dealer or service company. The cost of a professional installation is money well spent. Issues caused by incorrect installation may invalidate your warranty

Before you start to install your True unit, carefully inspect it for freight damage. If damage is discovered, immediately file a claim with the delivery freight carrier.

True is not responsible for damage incurred during shipment.

REQUIRED TOOLS

- Adjustable Wrench
- Phillips Head Screwdriver
- Level

UNCRATING

The following procedure is recommended for uncrating the unit:

- A.** Remove the outer packaging by pulling tri-wall nails from skid. Remove (4) cardboard corner pads and dust cover.
- B.** Inspect for concealed damage. Again, immediately file a claim with the freight carrier if there is damage.

C. Remove door bracket on swinging glass door models (see image 1-2)

Note: Keys for units with door locks are located in warranty packets.



LOCATING

- A.** Remove louver from the front of cabinet and backguard (if applicable) from rear of cabinet.
- B.** Skid bolts are located in each of 4 corners inside cabinet bottom. (See photo A).
- C.** Remove skid bolts. (See photo B).
- D.** Cut straps if applicable. (See photo C).
- E.** Carefully lift cabinet off of skid.



Removing skid from bottom of cabinet.

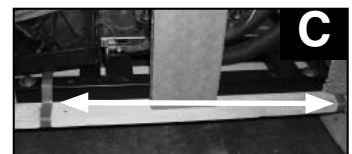

INSTALLATION / OPERATION INSTRUCTIONS

INSTALLATION OF LEGS AND CASTORS

Securing Castors:

To obtain maximum strength and stability of the unit, it is important that you make sure each castor is secure. The bearing race on the castor on the top edge of the leg must make firm contact with the rail.

Unit Leveling:

Four leveling shims have been provided for leveling castored units positioned on uneven floors. Shims must be positioned between rail end and bearing race. True recommends a four shim limit to any single castor.

- A.** Turn the bearing race counter-clockwise until the cabinet is level. Level front to back and side to side. (diagonally)
- B.** Install the desired number of shims, making sure the slot of the shim is in contact with the threaded stem of the castor.
- C.** If more than one shim is used, turn the slot at a 90° angle so they are not in line.
- D.** Turn the bearing race clockwise to tighten and secure the castor by tightening the anchoring bolt with a 3/4 inch open-end wrench, socket, or the tool provided.

CAUTION

To avoid damage to lower rail assembly, slowly raise unit to upright position after installing castors.



1 Thread castor into the underside of cabinet frame rail.



2 For leveling, insert the shim between the castor and frame rail.



3 Use the tool provided to tighten the castor into place.



4 Thread leg into cabinet bottom frame rail.



5 The end of the leg is adjustable to easy leveling.

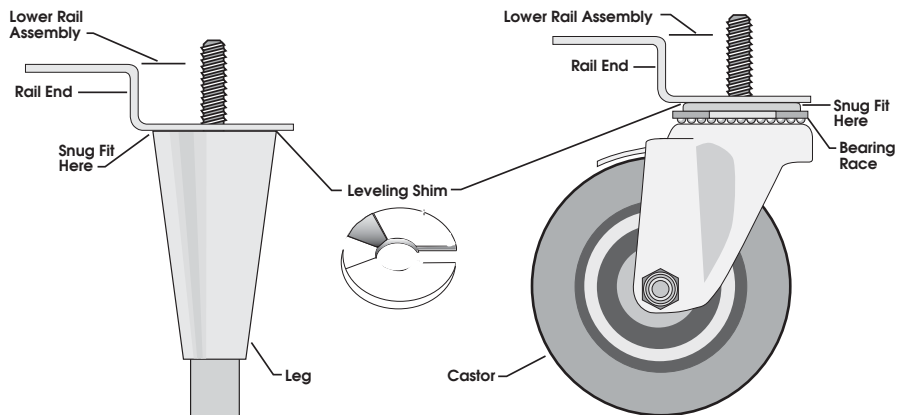

INSTALLATION / OPERATION INSTRUCTIONS

LEVELING

Step 4

A. Set unit in its final location. Be sure there is adequate ventilation in your room. Under extreme heat conditions, (100°F+, 38°C+), you may want to install an exhaust fan.

Warning

Warranty is void if ventilation is insufficient.

B. Proper leveling of your True heated cabinet is critical to operating success. Refer to "Installation of Legs and Castors" on page 5.

C. The cabinet should be leveled from the inside front to back and side to side with a level.

D. Ensure that the drain hose or hoses are

positioned in the pan.

E. Free plug and cord from inside the lower rear of the unit (do not plug in).

F. The unit should be placed close enough to the electrical supply so that extension cords are never used.

Warning

TRUE will not warranty any units that are connected to an extension cord.

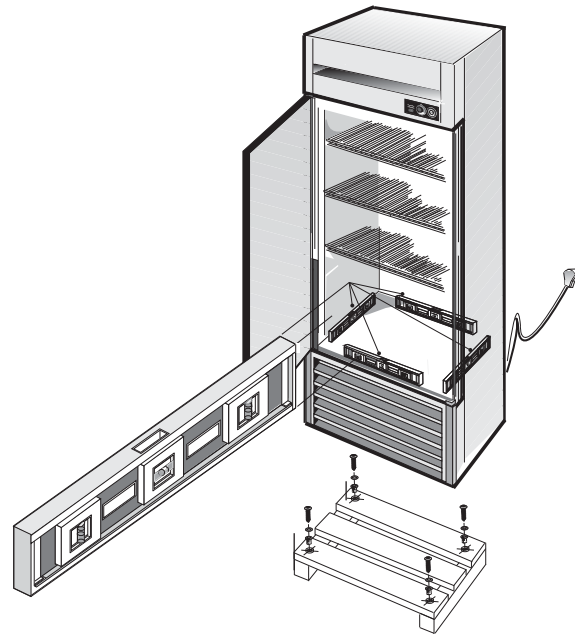

INSTALLING THE VENTILATION CAP

NOTE

Be sure unit is unplugged before proceeding.

A. Remove the ventilator cap, screws and gasket from the plastic bag located on the inside floor of heated cabinet.

Warning

Warranty is void if ventilation is insufficient.

B. Position the gasket at the existing ventilation hole on top of the cabinet. Place the ventilator cap above the ventilation hole and line up with gasket and mounting holes. Use the screws provided (4) to secure the ventilation cap.

NOTE

Some cabinets may not include predrilled mounting holes. In this case use the ventilator cap as a template, center over vent hole and mark all four hole locations. Drill mounting holes using a 3/32" bit.

Ventilation cap Top of cabinet

Gasket

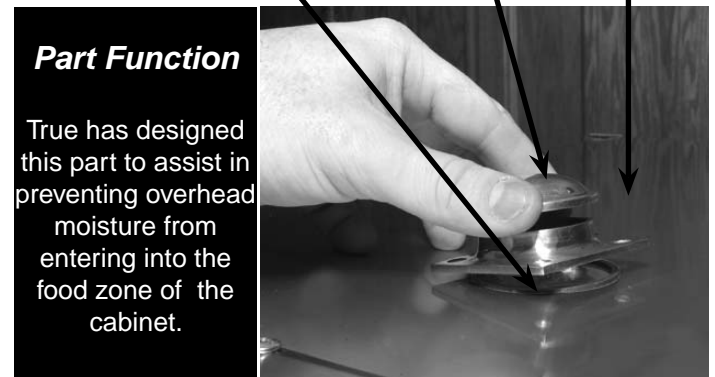

Part Function

True has designed this part to assist in preventing overhead moisture from entering into the food zone of the cabinet.

INSTALLATION / OPERATION INSTRUCTIONS

HUMIDIFICATION PROCEDURE

ADJUSTING HUMIDITY

The instruction is True's recommended procedure for providing interior humidity control

The heated cabinet is designed to provide flexibility in desired interior humidity.

LOW HUMIDITY

- A. Positioned in the interior ceiling of the cabinet is the manual humidity control.
- B. Turn counterclockwise to ventilate cabinet humidity.

HIGH HUMIDITY

- A. When cabinet contents require higher humidity, fill the 12" x 20" (31 x 51 cm) pan (provided) with water and place in the bottom of the cabinet.
- B. Keep pan full at all times; refilling as necessary.
- C. Close the vent described above.

ELECTRICAL INSTRUCTIONS

- A. Before your new unit is connected to a power supply, check the incoming voltage with a voltmeter. If anything less than 100% of the rated voltage for operation is noted, correct immediately.
 - B. All units are equipped with a 9 ft. (2.74 m) service cord, and must be powered at proper operating voltage at all times. Refer to cabinet data plate for this voltage.
- True** requires that a sole circuit be dedicated for the unit. Failure to do so voids warranty.

WARNING

Power supply cord ground should not be removed!

NOTE

To reference wiring diagram - Remove lower rear grill. Wiring diagram is positioned on the inside cabinet wall.

INSTALLATION / OPERATION INSTRUCTIONS

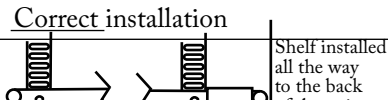
**Step 1 - Position Cabinet**

Allow one inch between the wall and rear of the unit to assure proper ventilation.

Warranty is void if ventilation is insufficient.

Step 2 - Level Cabinet

Cabinet should be level, side to side and front to back. Place a carpenter's level in the interior floor in four places:

- A. Position level in the inside floor of the unit near the doors. (Level should be parallel to cabinet front). Level cabinet.
- B. Position level at the inside rear of cabinet. (Again level should be placed parallel to cabinet back).
- C. Perform similar procedures to steps a & b by placing the level on inside floor (left and right sides - parallel to the depth of the cooler). Level cabinet.

Step 3

Draw an outline on the base on the floor.

Step 4

Raise and block the front side of the cabinet.

Step 5

Apply a bead of "NSF Approved Sealant", (see list below), to floor one half inch inside the outline drawn. The bead must be heavy enough to seal the entire cabinet surface when it is down on the sealant.

Step 6

Raise and block the rear of the cabinet

Step 7

Apply sealant on floor as outline in Step 5. on other three sides.

Step 8

Examine to see that cabinet is sealed to floor around entire perimeter.

Note:

Asphalt floors are very susceptible to Chemical attack. A layer of tape on the floor prior to applying the sealant will protect the door.

NSF Approved Sealants:

1. Minnesota Mining #EC800 Caulk
2. Minnesota Mining #EC2185 Caulk
3. Minnesota Mining #EC1055 Bead
4. Minnesota Mining #EC1202 Bead
5. Armstrong Cork - Rubber Caulk
6. Products Research Co. #5000 Rubber Caulk
7. G.E. Silicone Sealer
8. Dow Corning Silicone Sealer

INSTALLATION / OPERATION INSTRUCTIONS

STARTUP

RECOMMENDATION

Before loading product we recommend you run your True unit empty for twenty or thirty minutes. This allows you to be sure electrical wiring and installation are correct and no shipping damage has occurred. Remember, our factory warranty does not cover product loss!

REPLACEMENT PARTS

TRUE maintains a record of the cabinet serial number for your unit. If at any time during the life of your display case, a part is needed, you may obtain this part by furnishing the model number and serial number to the company from whom you purchased the cabinet. Call Toll-Free: (800)-424-TRUE (Direct to Parts Department). (800)-325-6152 (U.S.A. & Canada only) or call: (636)-240-2400.

Serial Number



SHELVING INSTALLATION / OPERATION

SHELF INSTALLATION:

Step 1

A. Hook shelf clips onto shelf standards.
(See illustration).

B. Position all four shelf clips equal in distance from the floor for flat shelves.

WIRE SHELVES:

Wire shelves are oriented so that cross support bars are facing down.

Step 2

Place shelves on shelf clips making sure all corners are seated properly.

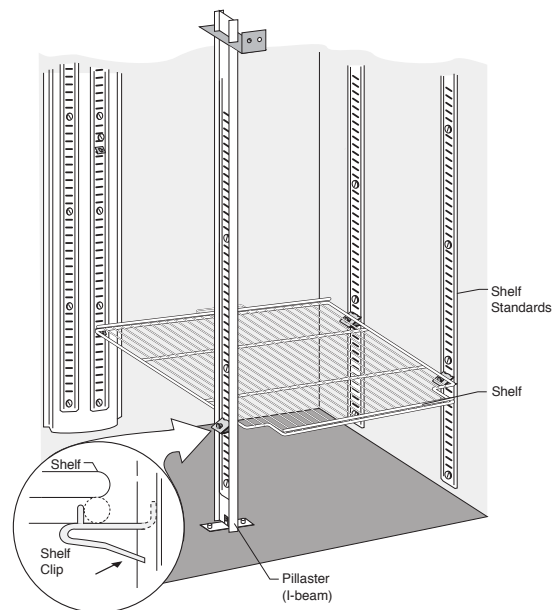

STAINLESS STEEL EQUIPMENT CARE AND CLEANING

CAUTION: Do not use any steel wool, abrasive or chlorine based products to clean stainless steel surfaces.

• **Stainless Steel Opponents**

There are three basic things which can break down your stainless steel's passivity layer and allow corrosion to rear its ugly head.

- 1) Scratches from wire brushes, scrapers, and steel pads are just a few examples of items that can be abrasive to stainless steel's surface.
- 2) Deposits left on your stainless steel can leave spots. You may have hard or soft water depending on what part of the country you live in. Hard water can leave spots. Hard water that is heated can leave deposits if left to sit too long. These deposits can cause the passive layer to break down and rust your stainless steel. All deposits left from food prep or service should be removed as soon as possible.
- 3) Chlorides are present in table salt, food, and water. Household and industrial cleaners are the worst type of chlorides to use.

8 steps that can help prevent rust on stainless steel:

1. Using the correct cleaning tools

Use non-abrasive tools when cleaning your stainless steel products. The stainless steel's passive layer will not be harmed by soft cloths and plastic scouring pads. Step 2 tells you how to find the polishing marks.

2. Cleaning along the polish lines

Polishing lines or "grain" are visible on some stainless steels. Always scrub parallel to visible lines on some stainless steels. Use a plastic scouring pad or soft cloth when you cannot see the grain.

3. Use alkaline, alkaline chlorinated or non-chloride containing cleaners

While many traditional cleaners are loaded with chlorides, the industry is providing an ever increasing choice of non-chloride cleaners. If you are not sure of your cleaner's chloride content contact your cleaner supplier. If they tell you that your present cleaner contains chlorides, ask if they have an alternative. Avoid cleaners containing quaternary salts as they can attack stainless steel, causing pitting and rusting.

4. Water Treatment

To reduce deposits, soften the hard water when possible. Installation of certain filters can remove corrosive and distasteful elements. Salts in a properly maintained water softener can be to your advantage. Contact a treatment specialist if you are not sure of the proper water treatment.

5. Maintaining the cleanliness of your food equipment

Use cleaners at recommended strength (alkaline, alkaline chlorinated or non-chloride). Avoid build-up of hard stains by cleaning frequently. When boiling water with your stainless steel equipment, the single most likely cause of damage is chlorides in the water. Heating any cleaners containing chlorides will have the same damaging effects.

6. Rinse

When using chlorinated cleaners you must rinse and wipe dry immediately. It is better to wipe standing cleaning agents and water as soon as possible. Allow the stainless steel equipment to air dry. Oxygen helps maintain the passivity film on stainless steel.

7. Hydrochloric acid (muriatic acid) should never be used on stainless steel

8. Regularly restore/passivate stainless steel

STAINLESS STEEL EQUIPMENT CARE AND CLEANING

Recommended cleaners for certain situations / environments of stainless steel

- A) Soap, ammonia and detergent medallion applied with a cloth or sponge can be used for routine cleaning.
- B) Arcal 20, Lac-O-Nu Ecoshine applied provides barrier film for fingerprints and smears.
- C) Cameo, Talc, Zud First Impression is applied by rubbing in the direction of the polished lines for stubborn stains and discoloring.
- D) Easy-off and De-Grease It oven aid are excellent for removals on all finishes for grease-fatty acids, blood and burnt-on foods.
- E) Any good commercial detergent can be applied with a sponge or cloth to remove grease and oil.
- F) Benefit, Super Sheen, Sheila Shine are good for restoration / passivation.

NOTE:

The use of stainless steel cleaners or other such solvents is not recommended on plastic parts. Warm soap and water will suffice.

WARRANTY INFORMATION (U.S.A. & CANADA ONLY!)

ONE YEAR PARTS & LABOR WARRANTY

TRUE warrants to the original purchaser of every new TRUE refrigerated unit, the cabinet and all parts thereof, to be free from defects in material or workmanship, under normal and proper use and maintenance service as specified by TRUE and upon proper installation and start-up in accordance with the instruction packet supplied with each TRUE unit. TRUE's obligation under this warranty is limited to a period of one (1) year from the date of original installation or 15 months after shipment date from TRUE, whichever occurs first.

Any part covered under this warranty that are determined by TRUE to have been defective within one (1) year of original installation or fifteen (15) months after shipment date from manufacturer, whichever occurs first, is limited to the repair or replacement, including labor charges, of defective parts or assemblies. The labor warranty shall include standard straight time labor charges only and reasonable travel time, as determined by TRUE.

WARRANTY CLAIMS

All claims for labor or parts must be made directly through TRUE. All claims should include: model number of the unit, the serial number of the cabinet, proof of purchase, date of installation, and all pertinent information supporting the existence of the alleged defect.

In case of warranty compressor, the compressor model tag must be returned to TRUE along with above listed information. Any action or breach of these warranty provisions must be commenced within one (1) year after that cause of action has occurred.

WHAT IS NOT COVERED BY THIS WARRANTY

TRUE's sole obligation under this warranty is limited to either repair or replacement of parts, subject to the additional limitations below. This warranty neither assumes nor authorizes any person to assume obligations other than those expressly covered by this warranty.

NO CONSEQUENTIAL DAMAGES. TRUE IS NOT RESPONSIBLE FOR ECONOMIC LOSS; PROFIT LOSS; OR SPECIAL, INDIRECT, OR CONSEQUENTIAL DAMAGES, INCLUDING WITHOUT LIMITATION, LOSSES OR DAMAGES ARISING FROM FOOD OR PRODUCT SPOILAGE CLAIMS WHETHER OR NOT ON ACCOUNT OF REFRIGERATION FAILURE.

WARRANTY IS NOT TRANSFERABLE. This warranty is not assignable and applies only in favor of the original purchaser/user to whom delivered. ANY SUCH ASSIGNMENT OR TRANSFER SHALL VOID THE WARRANTIES HEREIN MADE AND SHALL VOID ALL WARRANTIES, EXPRESS OR IMPLIED, INCLUDING ANY WARRANTY OF MERCHANTABILITY OR FITNESS FOR A PARTICULAR PURPOSE.

IMPROPER USAGE. TRUE ASSUMES NO LIABILITY FOR PARTS OR LABOR COVERAGE FOR COMPONENT FAILURE OR OTHER DAMAGES RESULTING FROM IMPROPER USAGE OR INSTALLATION OR FAILURE TO CLEAN AND/OR MAINTAIN PRODUCT AS SET FORTH IN THE WARRANTY PACKET PROVIDED WITH THE UNIT.

RESIDENTIAL APPLICATIONS: True assumes no liability for parts or labor coverage for component failure or other damages resulting from installation in non-commercial or residential applications.

ALTERATION, NEGLIGENCE, ABUSE, MISUSE, ACCIDENT, DAMAGE DURING TRANSIT OR INSTALLATION, FIRE, FLOOD, ACTS OF GOD. TRUE is not responsible for the repair or replacement of any parts that TRUE determines have been subjected after the date of manufacture to alteration, neglect, abuse, misuse, accident, damage during transit or installation, fire, flood, or act of God.

IMPROPER ELECTRICAL CONNECTIONS. TRUE IS NOT RESPONSIBLE FOR THE REPAIR OR REPLACEMENT OF FAILED OR DAMAGED COMPONENTS RESULTING FROM ELECTRICAL POWER FAILURE, THE USE OF EXTENSION CORDS, LOW VOLTAGE, OR VOLTAGE DROPS TO THE UNIT.

NO IMPLIED WARRANTY OF MERCHANTABILITY OR FITNESS FOR A PARTICULAR PURPOSE: THERE ARE NO OTHER WARRANTIES, EXPRESSED, IMPLIED OR STATUTORY, EXCEPT THE ONE (1) YEAR PARTS & LABOR WARRANTY AND THE ADDITIONAL FOUR (4) YEAR COMPRESSOR WARRANTY AS DESCRIBED ABOVE. THESE WARRANTIES ARE EXCLUSIVE AND IN LIEU OF ALL OTHER WARRANTIES, INCLUDING IMPLIED WARRANTY AND MERCHANTABILITY OR FITNESS FOR A PARTICULAR PURPOSE. THERE ARE NO WARRANTIES WHICH EXTEND BEYOND THE DESCRIPTION ON THE FACE HEREOF.

OUTSIDE U.S.: This warranty does not apply to, and TRUE is not responsible for, any warranty claims made on products sold or used outside the United States.

REMOTE CONDENSERS: True warrants the original purchaser of the remote cabinet one year parts and labor coverage for all cabinet parts thereof to be free from defects in material or workmanship, under normal and proper use and maintenance service, as specified by True. This warranty is limited to the cabinet only. True assumes no liability for remote condensing units.

Free Manuals Download Website

<http://myh66.com>

<http://usermanuals.us>

<http://www.somanuals.com>

<http://www.4manuals.cc>

<http://www.manual-lib.com>

<http://www.404manual.com>

<http://www.luxmanual.com>

<http://aubethermostatmanual.com>

Golf course search by state

<http://golfingnear.com>

Email search by domain

<http://emailbydomain.com>

Auto manuals search

<http://auto.somanuals.com>

TV manuals search

<http://tv.somanuals.com>