

# TUNTURI®

## FAMILY AND FAMILY SUPER

### OWNER'S MANUAL

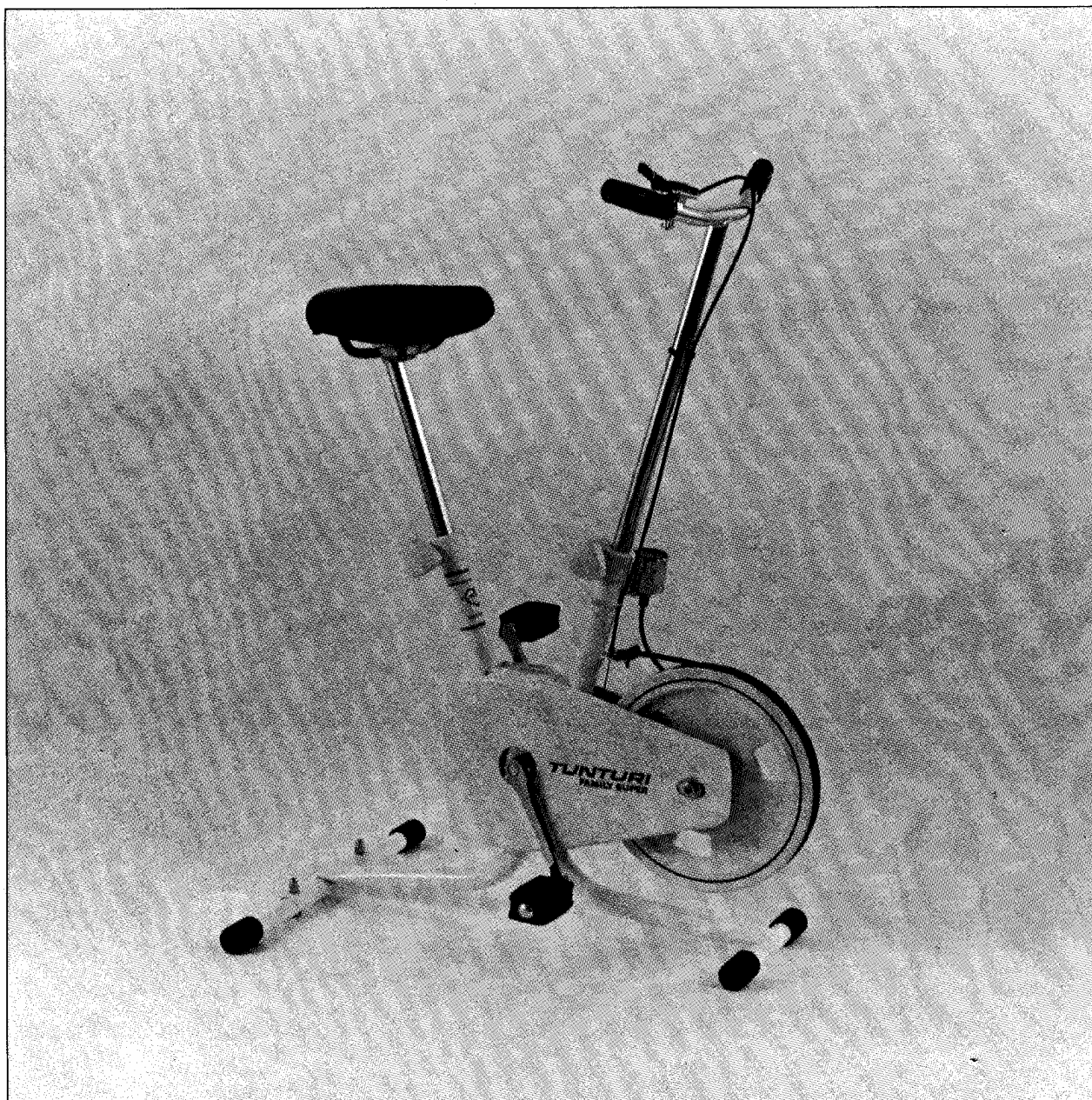

The Tunturi Family and Family Super are exercise cycles for home use. An ideal exerciser for all ages, the Tunturi Family can be adjusted to suit

children or adults, fit or not so fit. For the more demanding user, the Tunturi Family Super with its heavier cast-iron flywheel gives smoother

pedalling than the standard Family model.

# ASSEMBLY

The Family exercise cycle is easy to assemble using the tools supplied in the package as follows:

1. Push the handlebar column into the frame and tighten lightly. Fix the speedometer to the support by tightening the nut under the support. Connect the free end of the speedometer cable to the meter.

2. Fix the rear leg support in place by inserting the screw from below and tightening the nut from above with the wrench.

3. Unscrew the green plugs from the right-hand crank and pedal. Using the wrench provided, fix the pedal to the crank by turning clockwise.

4. Unscrew the red plugs from the left-hand pedal and crank. Fix the pedal to the crank turning in an anti-clockwise direction. The right and left pedals are also distinguished by the letters R and L stamped on their axles.

Make sure all screws and nuts are securely tightened before using the exercise cycle.

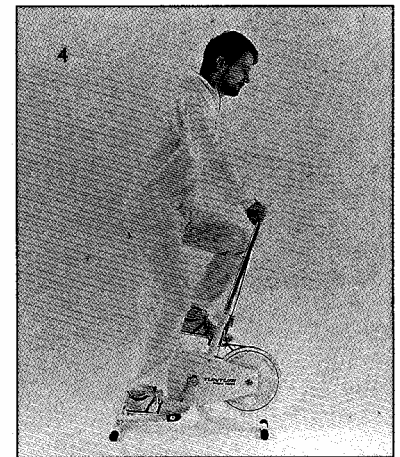
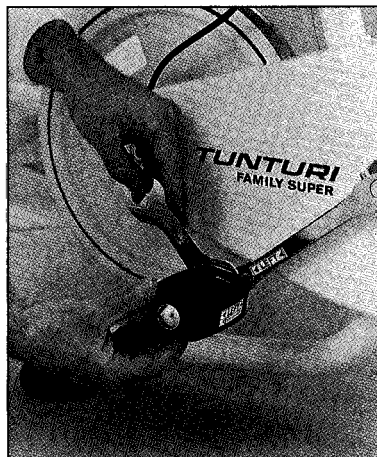
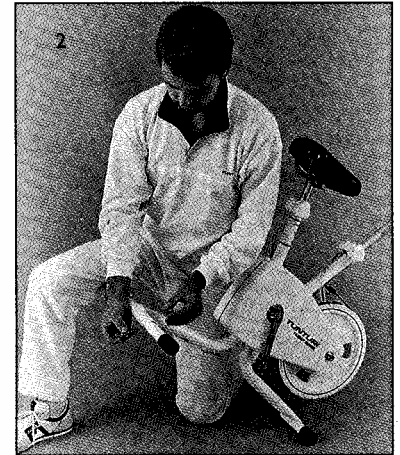
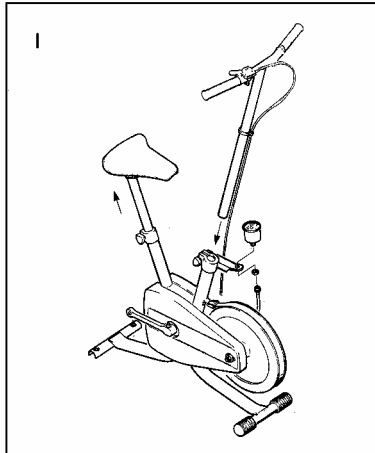

# ADJUSTMENTS

## Seat

Adjust the seat height so that, with the leg straight and the pedal in its lowest position, the ball of the foot reaches the pedal (fig. 4).

The seat angle can be adjusted by placing the required number of spacers under the securing screws.

## Handlebars

Loosen the triangular locking knob and adjust the handlebars so that the user can pedal comfortably with the arms almost straight. Never lift the handlebar or seat columns above the "Min" mark on the column.

## Resistance

Adjust resistance by turning the control lever on the handlebars. Pedalling should usually be started at a low resistance. After a few minutes' warming up, resistance can gradually be increased.

# MAINTENANCE AND STORAGE

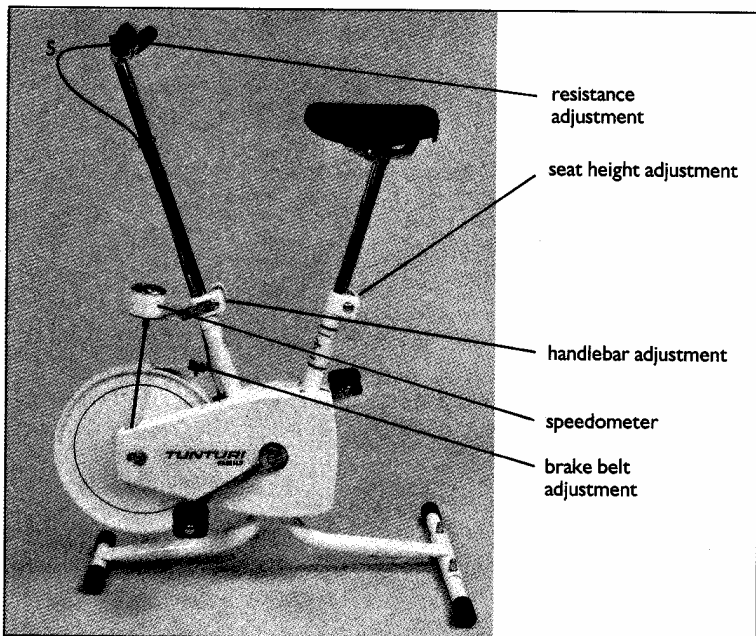

## Maintenance

The Tunturi Family and Family Super are durable and made to withstand continuous use. However, to keep your exercise cycle in good working order, it is important to carry out a few simple adjustment and maintenance procedures at regular intervals:

### Brake belt:

Adjust brake belt tightness if required. To do this, open the clasp above the flywheel and tighten the belt by pulling it. When the tension is correct, the flywheel should rotate freely with the resistance control lever at 0.

### Chain

The chain should be lubricated with a suitable oil twice a year. Remove the right-hand chain guard and apply lubricant, preferably with a spray.

If the chain is noisy, it is either too tight or loose. Adjust by loosening the flywheel axle nuts and moving the flywheel either backwards or forwards. Make sure that the chain is in alignment after retightening the nuts.

Grease the handlebar and seat height adjustment screw threads with vaseline e.g. twice a year.

Any water-solvent detergent can be used for cleaning the outer casing. Solvents should not be used.

## Storage

Store the Tunturi Family in a dry place with as little temperature variation as possible and protect it from dust. It is not advisable to use

the cycle in damp conditions, as the braking surface on the flywheel may rust, resulting in faulty operation.

# TECHNICAL DATA

- length 74 cm
- width 51 cm
- height 80 - 110 cm
- weight 14 kg, Super 19 kg
- weight of flywheel 2 kg, Super 8 kg
- handlebar height adjustment 30 cm
- seat height adjustment 30 cm
- robust steel tube frame
- long-lasting brake belt allowing stepless adjustment of resistance
- white impact-resistant baked-on enamel finish
- speedometer
- safe, completely enclosed construction

# SPARE PARTS

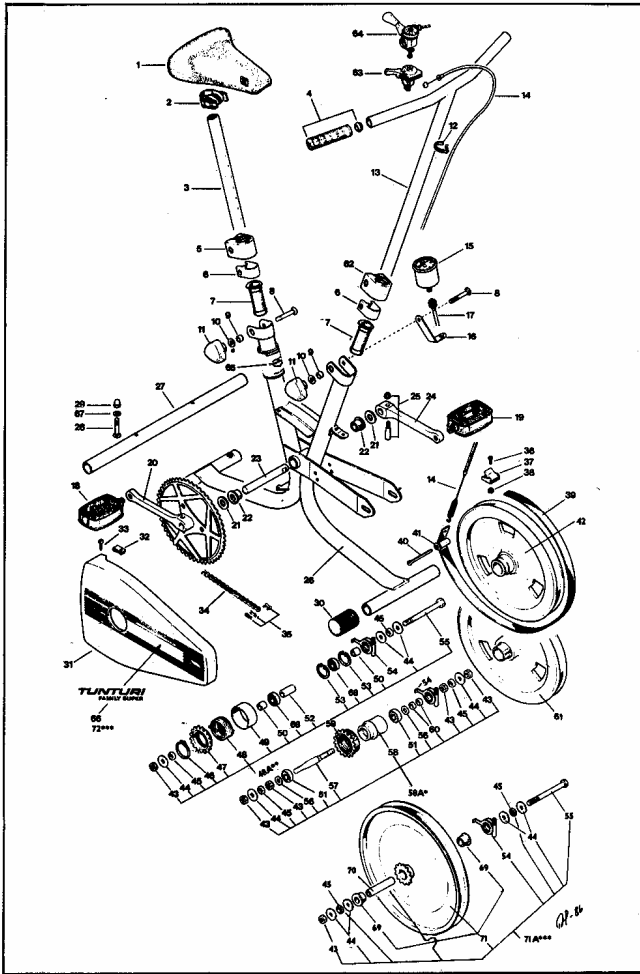

Picture No.	Part No.	Picture No.	Part No.
1	153.10785	39	443.106.77
2	503.111.83	40	663.105.83
3	153.155.83	41	533.106.78
4	212.102.85	42	303.112.85
5	173.112.83	43	61.1001
6	513.204.82	44	62.1028.10
7	533.122.83	45	533.115.83
8	653.172.83	46	673.103.85
9	523.104.81	47	263.106.85
10	653.132.83	48	643.109.85
11	653.104.79	48A	333.109.86**
12	223.118.82	49	263.108.85
13	203.102.77	50	533.150.85
14	223.134.86	51	523.501.82
15	233.145.83	52	533.149.85
16	503.122.87	53	673.102.85
17	223.124.83	54	233.143.83
18-19	363.135.84	55	60.10.110.02
18	363.136.84	56	62.1016.15
19	363.137.84	57	343.111.84
20	353.103.85	58	333.106.84
21	62.1628.10	58A	333.10784*
22	523.105.83	58, 61	303.113.84
23	343.108.83	59	263.105.84
24	353.104.85	60	333.102.68
25	663.104.83	62	173.112.83.1
26	103.120.85	63	213.101.77
27	103.106.77	64	223.131.85
28	60.08.040.40	65	423.163.71
29	61.0821	66	423.121.84
30	533.153.85	67	62.081710
31	143.116.83	68	523.10785
32	651.900.70	70	343.109.83
33	60.48.013.50	71	303.106.83
34-35	252.03710	71A	303.11786***
35	252.000.11	72	423.10783***
36	60.05.015.17		
37	503.11785		
38	61.0510		

\*Family Super (Mod. Eur.)  
 \*\*Family Super (Mod SF)  
 \*\*\*Family

## WHAT TO DO IF...

FAULT	REASON	ACTION
Handlebar or seat not secure	Adjustment knob does not tighten	Unscrew the knob and grease the threads. Retighten by hand.
Brake not operating	Brake belt loose	Open clasp and tighten belt.
Pedal not secure	Axle loose	Screw pedal onto crank with wrench. See Assembly, 3.
Chain noisy	Chain dry	Remove right-hand chain guard and oil chain.
	Chain tight	Loosen flywheel nuts and move flywheel backwards or forwards.
	Chain out of alignment	Remove right-hand chain guard. Loosen flywheel axle nuts and move flywheel sideways until chain is in alignment. Retighten the nuts.
Chain rubbing against chain guard	Chain loose or too near guard	Open flywheel axle nuts and move flywheel forward.

### TUNTURI®

Manufacturer: Tunturipyörä Oy  
 20760 Piispanristi, Finland  
 Tel. +358-21-603 1111 Telex 62 617  
 Telefax +358-21-603 323

## Free Manuals Download Website

<http://myh66.com>

<http://usermanuals.us>

<http://www.somanuals.com>

<http://www.4manuals.cc>

<http://www.manual-lib.com>

<http://www.404manual.com>

<http://www.luxmanual.com>

<http://aubethermostatmanual.com>

Golf course search by state

<http://golfingnear.com>

Email search by domain

<http://emailbydomain.com>

Auto manuals search

<http://auto.somanuals.com>

TV manuals search

<http://tv.somanuals.com>