

J6 / J6F

Owner's Manual :: 2-19

GB

Mode d'emploi :: 20-37

F

Manual del usuario :: 38-55

E

Gebruikers gids :: 56-73

NL

583 4024D
© TUNTURI 2001

TUNTURI[®]
THE MOTOR – *it's you.*

IMPORTANT SAFETY INSTRUCTIONS

This Owner's Manual is an essential part of your training equipment: reading all instructions in this manual before you start using this appliance. The following precautions must always be followed:

WARNING:

- :: Never use extension cords between the treadmill and your wall outlet. The device's maximum power consumption is 10 A (EU) /20 A (US). Outlets with fluctuating voltage of more than 5 %, may result in erratic performance or cause damage to treadmill electronics. Using electrical power other than that which has been specified in this manual, will ultimately void any warranty, implied or otherwise.

WARNING: to reduce any risk to persons:

- :: Keep hands clear of any moving parts. Never place hands, feet or any other objects into any opening or under the treadmill.
- :: Never leave the treadmill unattended when plugged in. Unplug from outlet when not in use, before putting on or taking off parts. To disconnect, turn all controls to the off position, then remove plug from outlet.
- :: Close supervision is necessary when the treadmill used by, on, or near children, invalids, or disabled persons.
- :: Use the treadmill only for its intended use as described in this manual. Do not use attachments not recommended by Tunturi.
- :: Before you start using the treadmill, make sure that it functions correctly in every way. Do not use a faulty device.
- :: Keep the cord away from heated surfaces.
- :: J6 / J6F must not be used outdoors. J6 / J6F tolerates an environment measuring +10°C to +35°C. Air humidity must never exceed 90 %.
- :: Do not attempt any servicing or adjustment other than those described in this manual. The given instructions must be followed carefully.
- :: Never operate this treadmill if it has a damaged cord or plug, if it has been dropped or damaged, or dropped into water. Return the treadmill to a service center for repair.
- :: Never operate the appliance with the air opening blocked. Keep the air openings free of lint, hair, and the like.
- :: Do not operate where aerosol (spray) products are being used or where oxygen is being administered.

SAVE THESE INSTRUCTIONS!

WELCOME TO THE WORLD OF TUNTURI EXERCISING!

Your choice shows that you really want to invest in your well-being and condition; it also shows you really value high quality and style. With Tunturi Fitness Equipment, you've chosen a high-quality, safe and motivating product as your training partner. Whatever your goal in training, we are certain this is the training equipment to get you there.

ASSEMBLY ::

The figures referred to in the text are in the back fold. Before assembling the device, insure all parts are present (**FIGURE 1**):

1. Frame
2. Power cord
3. Assembly kit (contents are marked with an * in the spare part list)

In case of problems contact your Tunturi dealer. The packaging includes a disposable silicate bag for absorbing moisture during storage and transportation. The directions left, right, front and back are defined as seen from the exercising position.

J6: HAND RAIL AND INTERFACE (FIGURES 2 3 AND)

Turn the user interface until the holes for the locking screws are in position and then attach by tightening the 4 screws (M6x12) on the rear side. Cut the green ribbon and attach the corner pieces to the hand rail with Allen screws, do not tighten much yet. Lift the handrail to the upright position, place the cover tubes between corner pieces and the frame and thread the attachment bolts through the tubes. Tighten the bolts with nuts and the Allen screws on both sides. Place the transportation wheels on the axles on the lower end of the hand rail, set the locking sleeve at the end of the axle and attach it by knocking the assembly tool gently. Attach the 2 screws (M6x12) on the front side of the interface and remove the protective film from the display.

J6F: HAND RAIL AND INTERFACE (FIGURES 5, 6 AND 7)

Turn the user interface until the holes for the locking screws are in position and then attach by tightening the 4 screws (M6x12) on the rear side. Cut the green ribbon of the hand rail. Push the ends of the U-shaped frame of the front into the hand rail ends and push the attachment bolts into place. Run the elevation to 0 % (see Power Cord, Tether Key and Interface) and lift the hand rail to the upright position. Push the U-shaped frame with the transportation wheels into place: two people are needed for the installation. Tighten the attachment bolts carefully on both sides. Attach the lower end of the gas spring to the folding frame with a screw and a nut. Attach the 2 screws (M6x12) on the front side of the interface and remove the protective film from the display.

POWER CORD AND GROUNDING INSTRUCTIONS

Plug the socket end of the power cord into the treadmill at the lower right front corner. Before connecting the device to a power source, make sure that local voltage matches that indicated on the type plate. The treadmill operates at either 230 V or 120 V (US-version). Turn on the power using the switch next to the socket on the treadmill.

This treadmill must be grounded. If it should malfunction or breakdown, grounding provides a path of least resistance for electrical current to reduce the risk of electrical shock. This product is equipped with a cord having an equipment-grounded conductor and a grounding plug. The plug must be plugged into an appropriate outlet that is properly installed and grounded in accordance with all local codes and ordinances. Do not use extension cables when connecting the equipment to the power source.

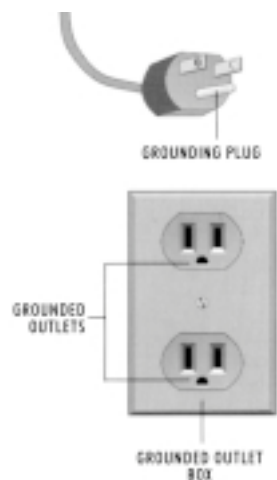

DANGER! Improper connection of the equipment-grounding conductor can result in a risk of electric shock. Check with a qualified electrician or serviceman if you are in doubt as to whether the product is properly grounded. Do not modify the plug provided with the product - if it will not fit the outlet, have a proper outlet installed by a qualified electrician.

NOTE! The version for use on a nominal 120-volt circuit has a grounding plug that looks like the plug illustrated. Make sure that the product is connected to an outlet having the same configuration as the plug. No adapter should be used with this product.

SAFETY TETHER KEY

The treadmill cannot be used if the tether key is not properly installed in the meter base; if the key is removed from its place near the electronic display, the treadmill will immediately stop. Insert the safety tether key into the meter base. Ensure that the clip of the safety tether key is properly attached to your clothing; as the cord tightens, make sure the clip does not detach itself from your clothing before the safety tether key disconnects from the user interface.

EXERCISING ::

No matter what your goal, you'll get the best results by training at the right level of effort, and the best measure is your own heart-rate. First find your maximum heart-rate i.e. where the rate doesn't increase with added effort. If you don't know your maximum heart-rate, please use the following formula as a guide:

Women: 226 - age

Men: 220 - age

These are average values and the maximum varies from person to person. The maximum heart-rate diminishes on average by one point per year. If you belong to one of the risk groups mentioned earlier, ask a doctor to measure your maximum heart-rate for you.

We have defined three different heart-rate zones to help you with targeted training.

Beginner: 50-60 % of maximum heart-rate

Also suitable for weight-watchers, convalescents and those who haven't exercised for a long time. Three sessions a week of at least a half-hour each is recommended. Regular exercise considerably improves beginners' respiratory and circulatory performance and you will quickly feel your improvement.

Trainer: 60-70 % of maximum heart-rate

Perfect for improving and maintaining fitness. Even reasonable effort develops the heart and lungs effectively, training for a minimum of 30 minutes at least three times a week. To improve your condition still further, increase either frequency or effort, but not both at the same time!

Active trainer: 70-80 % of maximum heart-rate

Exercise at this level suits only the fittest and presupposes long-endurance workouts.

BEGINNING AN EXERCISE SESSION

- :: To avoid muscular pain and strain, begin and end each workout by stretching.
- :: Stand on the landing rails to the left and right of the running belt. Do not stand on the running belt.
- :: Always hold the handrail for support when getting on or off the treadmill and when changing the speed during exercise. Do not jump off the running belt while it is moving!
- :: If you experience nausea, dizziness or other abnormal symptoms while exercising, stop your workout at once and consult a physician.

FINISHING AN EXERCISE SESSION

- :: Never leave the safety tether key in the treadmill.
- :: Use the main power switch to turn the unit off.
- :: Unplug the electrical cord from the wall outlet and from the treadmill.
- :: If necessary clean the treadmill from sweat with a damp cloth. Do not use solvents.
- :: Store the electrical cord where it is clear from all pathways and out of childrens' reach.

HOW TO MOTIVATE YOURSELF TO CONTINUE

In order to reach the goals you have set, you'll need to keep finding the motivation to continue so you achieve your ultimate goal: life-long health and a new quality of living.

- :: Set yourself realistic targets.
- :: Progress step-by-step according to your schedule.
- :: Keep a fitness diary and write down your progress.
- :: Change your way of exercising from time to time.
- :: Use your imagination.
- :: Learn self-discipline.

One important aspect of your training is versatility. Varying your training exercises different muscle groups and helps maintain motivation.

INTERFACE ::



FUNCTION KEYS

Manual is the default basic exercise mode when the device is switched on. In Manual mode you control the treadmill yourself.

♥ **Control** offers three different standard heart-rate exercises.

Prog provides a fitness test and 4 pre-programmed exercise profiles.

Set helps you define user weight, heart-rate alarm limits, audio signal use and units of measurement.

Reset is the key to reset time, distance and energy consumption displays for all exercises.

CUSTOM START

In Manual mode, use Custom Start to begin an exercise where speed and elevation are preset by the user. You can save the Custom Start values by setting the desired speed and elevation, and then pressing the Custom Start key for 2 seconds: an audio signal indicates that the setting is saved. For user safety, the speed range on the key is 0,5-10 km/h (0,3-6,2 mph).

SETTING KEYS, OK AND SCAN

Setting keys are used to set the values on-screen. The left/right keys are used for navigation, while the up/down keys are used to set values.

The OK key in the middle of the setting keys is used to confirm your selections.

Pressing SCAN key changes the displayed values.

SPEED CONTROL KEYS

Speed control keys (Tortoise/Hare) are located below the display. Hare key increases the belt speed in 0,1 km/h (or 0,1 mph) increments, the tortoise key decreases it in 0,1 km/h (or 0,1 mph) increments. Pressing these keys longer makes the speed change faster. Track speed ranges from 0,5-16 km/h (0,3-10 mph).

ELEVATION CONTROL KEYS

Elevation control keys (elevation arrows up and down) are located below the display. The elevation up key increases the elevation in 1 % increments, the elevation key down decreases it in 1 % increments. Track elevation ranges from 0 % (horizontal) to 10 %.

STOP

Press STOP to end your exercise.

Press STOP once in exercise profile training and the treadmill stops and moves into its waiting state for 5 minutes. You can restart the interrupted exercise by pressing the Hare key within 5 minutes. Press STOP twice to end your exercise.

DISPLAYS

A signal light indicates which parameter is being used.

- :: Speed = running deck speed (0,5-16 km/h / 0,3-10 mph).
- :: kcal = energy consumption (0-9999 kcal).
- :: Time = exercise duration (at 1 second intervals 00:00-59:59 up to 1 hour, and at 1 minute intervals thereafter 1:00-99:59).
- :: Elev = elevation angle (0-10 %). 1 % corresponds to a 1 metre rise per 100 metres.
- :: Dist = training distance (0.1-999.9 km).
- :: Pulse = heart-rate measurement (0-220). A heart-rate belt is required to measure the heart-rate. The user interface displays — if the heart-rate measurement feature is not in operation.

ERROR CODES

The user interface will display information about any operational faults. An error code begins with the abbreviation Err.

- 13 Running deck speed exceeds set value: Please follow this manual's instructions on using the device.
- 15 Running deck does not respond to controls: Please check running deck lubrication and follow this manual's instructions on using the device.
- 71 Lift motor fault or lifting motor overload protection off: Please switch the device off for 5 minutes and then restart. If the error message does not disappear, please contact your local Tunturi distributor.

Remove the error code by pressing the RESET key. If any of these error codes appears repeatedly despite servicing, or if a code other than the above is displayed constantly, please contact your Tunturi dealer.

SET AND RESET ::

In Set you can define user weight, heart-rate alarm limits, audio signal use and units of measurement as follows:

1. Press the Set key.
 - :: Setting Set 1 (user weight) is displayed. Set the required value in the central display with the up/down setting. Press OK to confirm your choice; that will also always move you forward to setting the next value.
 - :: Setting Set 2 (minimum heart-rate value) is displayed. Set the desired value in the central display with the up/down setting keys. In standard heart-rate exercises, your heart-rate will then be kept above the limit you set. Press OK to confirm your choice.
 - :: Setting Set 3 (maximum heart-rate value) is displayed. Set the desired value in the central display with the up/down setting keys. In standard heart-rate exercises, your heart-rate will then be kept below the limit you set. Press OK to confirm your choice.
 - :: Setting Set 4 (audio signal use) is displayed. "AUd On" indicates the audio signal is on and "AUd OFF" that it's off. Use the up/down setting keys to make your choice. Press OK to confirm.
 - :: Setting Set 5 (measurement unit selection) is displayed. "EU" stands for the metric system and "US" for Imperial units. Use the up/down setting keys to make your choice. Press OK to confirm.
 - :: To remove the heart-rate alarm limits, go to alarm limit setting and press the Reset key.
2. You can move from the Set function by pressing Manual, Pulse Control or Prog key.

NOTE! Pressing the Set key during an exercise will stop the belt and finish the exercise.

The Reset key resets energy consumption, time and distance displays for all exercises.

MANUAL ::

Manual is the default user-controlled basic exercise mode when the device is switched on. In contrast to profile exercises, Manual means you can adjust running deck speed and elevation yourself during an exercise, if necessary.

1. Start the treadmill or press the Manual key.
2. Start the training by pressing the Hare key. The belt will start moving at 0,5 km/h (or 0,3 mph). By pressing the Custom Start key, the belt accelerates to the preset speed and elevation values.
 - :: You can save the Custom Start values by setting the desired speed and elevation, and then pressing the Custom Start key for 2 seconds: an audio signal indicates that the setting is saved. For user safety, the speed range on the key is 0,5-10 km/h (0,3-6,2 mph).
3. Steady yourself by holding onto the handlebars and carefully stepping onto the moving belt. Increase speed by pressing the Hare key until the desired speed is reached. To slow down, press the Tortoise key.
4. Adjust the elevation during the training by using the elevation arrow keys. The Arrow up-key increases the elevation in 1 % increments. The back of the treadmill goes down increasing the elevation. The Arrow down-key decreases the elevation in 1 % increments. The back of the treadmill will rise decreasing the elevation.

♥ CONTROL ::

Standard heart-rate exercises enable training within a selected heart-rate level.

Constant heart-rate exercise requires your using the heart-rate measurement system.

1. Select the desired heart-rate mode by pressing the ♥ Control key (indication light shows the selected mode):
 - :: **Speed (indication light <<<)** = pulse control is based on changing belt speed. If you wish, you can change the inclination angle of the belt during training.
 - :: **Elevation (indication light up/down)** = pulse control is based on changing treadmill inclination. In this mode, you must adjust the belt speed with the Hare and Tortoise keys.
 - :: **Combination (both indication lights)**= automatic equal adjustment of both the inclination angle and the speed of the belt.
2. Set the desired heart-rate with the up/down setting keys.
 - :: Press OK to confirm.
3. Press the Hare key to start constant heart-rate exercise.
 - :: You can adjust the heart-rate level with the up/down setting keys during the exercise.
 - :: In the Speed and Combination exercises, you can set the upper limit to belt speed (default: 12 km/h / 7,4 mph) by pressing the Tortoise key during the exercise. You can adjust the belt speed limit with the Hare and Tortoise keys during the exercise.
 - :: You can change the heart-rate mode during the exercise.

PROG ::

The recovery heart-rate feature and profiles 3 and 4 require heart-rate measurement.

EXERCISE PROFILES

1. Press the Prog key to display PrOF.
 - :: Press OK to confirm.
2. Pro 1 (profile 1) and L1 (demand level 1) appear on display. Select the required profile (1-4) with the up/down setting keys, then use the left/right setting keys to move to demand level selection (1-3). Select your level with the up/down setting keys. There is a detailed description of the exercise profiles at the end of this manual.
 - :: Press OK to confirm.
3. Start the exercise profile selected by pressing the Hare key.
4. Press STOP once and the treadmill stops and moves into its waiting state (hold) for 5 minutes. You can restart the interrupted exercise during the waiting state by pressing the Hare key. Once the 5 minute waiting period is over, the exercise has ended and the device returns to profile selection state. You can also end your exercise by pressing the STOP key twice.

MEASUREMENT OF RECOVERY PULSE

1. Press PROG key twice. The text rECO appears on display.
 - :: Press OK to confirm.

The measurement of recovery pulse takes two minutes, during which time the text rECO and the current heart rate are displayed. At the end of the period the text rESU and the recovery ratio percentage are displayed. The smaller the reading the fitter you are. Note that results are dependent on the starting pulse level, they are individual and not directly comparable with those of others.

MAINTENANCE ::

CAUTION! Do not attempt any servicing or adjustment other than those described in this manual. Any other servicing must be performed by an authorized service representative.

Check the tightness of all fixing screws once a year. Do not overtighten.

LUBRICATING THE RUNNING DECK

Lubrication is the most important service activity for the treadmill. This is absolutely essential, if the friction of the running deck increases noticeably or the motor begins to heat up; increased friction is indicated by jerky movement of the belt or by error code 15 appearing on the display. Insufficient lubrication will cause the belt, running deck and motor to wear out and break. The running belt is factory treated with wax, which significantly reduces the need for additional lubrication. The need for relubrication depends to a great extent on the running styles and weight of the user: heavy user weight and slow speed put particular strain on the device and therefore demand greater lubrication. We recommend you check the lubrication after every 50 hours of use. Use only T-Lube lubricant to lubricate the treadmill. Contact your local Tunturi distributor for further supplies of T-Lube.

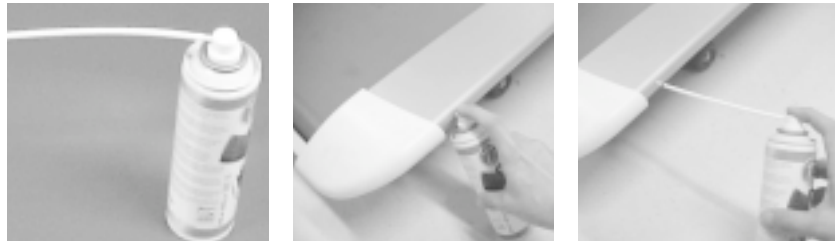

- :: Attach the nozzle to the T-Lube container.
- :: Let the treadmill run at 5 km/h (3 mph).
- :: Push the nozzle completely into the lubrication pipe. Spray T-Lube into the pipe, at the same time pulling the nozzle out of the pipe until the marking on the nozzle appears. The lubrication should last for 2-3 seconds. Repeat the lubrication on the other side of the treadmill.
- :: The treadmill is instantly ready for use.

NOTE! The device must never be lubricated with silicone!

CLEANING THE TREADMILL

Wipe the treadmill surfaces, especially the handlebars and meter from dust with a damp cloth or towel. Do not use solvents.

Use a small vacuum nozzle to carefully vacuum around all visible components (belt, running deck, side rails etc.). To clean the underside of the treadmill, carefully turn the treadmill on its side, or if your treadmill is J6F, lift the running deck to the storage position.

ALIGNING THE RUNNING BELT

Monitor belt tracking during exercise and make adjustments as needed. The belt should run in the centre of the treadmill. Alignment is not usually needed, provided

- :: the treadmill is placed on an even, solid and horizontal surface and the belt is correctly tensioned
- :: the alignment of the belt is correct

It is, however, possible for the belt to be pushed to one side due to the user's running style (e.g. more weight on one foot). The alignment of the belt is adjusted by turning the two bolts at the back of the treadmill. Align the belt according to the following instructions:

1. Turn the power switch on and increase the treadmill's speed to 5 km/h (3 mph).
2. If the belt drifts to the left, turn the left adjustment bolt 1/8 turn clockwise and the right adjustment bolt 1/8 turn anticlockwise. Do not turn more than 1/8 at the time as already very small adjustments effect the alignment.
 - :: If the belt drifts to the right, turn the right adjustment bolt 1/8 turn clockwise and the left adjustment bolt 1/8 turn anticlockwise.
3. If the belt remains centered the adjustment is correct. If not, continue to make small adjustments as above until the belt is correctly aligned.

If the belt is allowed run across to one side for long periods of time the edges of the belt may be damaged and the treadmill may not continue to operate correctly. **Any damage to the belt caused by the lack of necessary adjustment will not be covered by the warranty.**

ADJUSTING THE BELT TENSION

The belt must be tensioned if it begins to slip on the rollers. In normal use, however, keep the belt as loose as possible! The belt tension is adjusted by turning the same screws as used for aligning the running belt. If turning the screws will not effect the belt tension, please contact your Tunturi dealer.

1. Increase the treadmill's speed to 5 km/h (3 mph).
2. Turn both adjustment screws an equal amount, 1/8 turn clockwise.
3. Try to slow the belt down by holding onto the handrails and braking as you walk (as if you were walking downhill). If the belt slips, turn another 1/8 turn and repeat the test. When braking heavily the belt may slip.



MALFUNCTIONS

NOTE! Despite continuous quality control, defects and malfunctions caused by individual components may occur in the equipment. In most cases it's unnecessary to take the whole device in for repair, as it's usually sufficient to replace the defective part. If you require spare parts or the equipment does not function properly during use, contact your Tunturi dealer. Always give the model, serial number of your equipment and in case of malfunctions also conditions of use, nature of malfunction and any error code. Use only spare parts mentioned in the spare part list.

If there is a fault in the user interface display, unscrew the 10 locking screws. Detach the cable connector by pressing the clip towards the cable and pulling it off. Be careful not to drop the cable inside the tube. Please contact your local Tunturi distributor for further information on repairing or replacing the meter. When reinstalling the user interface, please tug lightly at the cable to make sure that it's properly locked.

NOTE! The text "Self cal" on display indicates automatic re-calibration of the lift motor.

MOVING AND STORAGE ::

Before moving J6, be sure the power cord is unplugged from the wall and the treadmill. Lift the treadmill from the rear to an angle of about 30 degrees and push it on the front wheels. Lower the treadmill carefully onto the floor.

You can lift up the running deck of J6F to a space-saving storage position: Turn off the power switch. Take hold of the frame tube underneath the rear part of the running base and lift the running base up.

CAUTION! The gas spring is designed to make lifting the running base easier. Always remember to ensure that the running base is locked in the storage position!



Before moving J6F, be sure the power cord is unplugged from the wall and the treadmill; lift up the running base until it becomes locked. Stand behind the treadmill and support it with your foot on a transportation wheel, grip the hand rails and tilt the treadmill towards yourself so that it rests on the transportation wheels. Lower the treadmill carefully onto the floor, again supporting it with your foot.

NOTE! Transport the treadmill with extreme caution over uneven surfaces, for example over a step. The treadmill should never be transported upstairs using the wheels over the steps, instead it must be carried.

NOTE! The running belt needs to be realigned and centered after moving.

To prevent malfunctioning of the treadmill, store it in a dry place with as little temperature variation as possible, protected against dust. Always unplug the treadmill from the electrical outlet when not in use.

TECHNICAL DATA ::

Length (storage position)	153 cm / 60" (70 cm / 28")
Height (storage position)	142 cm / 56" (155 cm / 61")
Width	82 cm / 32"
Weight	80 kg / 177 lbs
Running surface	46 x 135 cm / 18 x 53"
Speed	0,5 -16 km/h / 0,3-10 mph
Elevation range	0 - 10 %
Motor	1,8 HP (continuous duty)

J6 / J6F treadmill meets the requirements of the EU's EMC Directives on electromagnetic compatibility (89/336/EEC) and electrical equipment designed for use within certain voltage limits (73/23/EEC). This product therefore carries the CE label.

J6 / J6F North American versions (120 V) comply with FCC requirements on electromagnetic compatibility and are accordingly marked with the FCC label.

J6 / J6F treadmill meets EN precision and safety standards (Class A, EN-957, parts 1 and 6).

Due to our continuous policy of product development, Tunturi reserves the right to change specifications without notice.

CAUTION! The instructions must be followed carefully in the assembly, use and maintenance of your equipment. The warranty does not cover damage due to negligence of the assembly, adjustment and maintenance instructions described herein. Changes or modifications not expressly approved by Tunturi Oy Ltd will void the user's authority to operate the equipment!



TIPS ::

ABOUT YOUR HEALTH

- :: Before you start any training, consult a physician to check your state of health.
- :: If you experience nausea, dizziness or other abnormal symptoms while exercising, stop your workout at once and consult a physician.
- :: To avoid muscular pain and strain, begin and end each workout by stretching.

ABOUT THE EXERCISE ENVIRONMENT

- :: J6 / J6F is designed for household use only.
- :: Make sure the exercise environment has adequate ventilation. To avoid catching cold, do not exercise in a draughty place.
- :: Place the treadmill on a firm, level surface. Allow 120 cm or 4 feet of clearance behind the treadmill and 60 cm or 2 feet on either side and in front of the treadmill.
- :: We recommend that the equipment is placed on a protective base.

ABOUT USING THE EQUIPMENT

- :: Always unplug the treadmill from the electrical outlet after each training session.
- :: Only one person may use the equipment at a time.
- :: Keep hands clear of any moving parts. Never place hands, feet or any other objects under the treadmill.
- :: Wear appropriate clothing and shoes when exercising. Make sure your shoelaces are properly tied. To avoid injury and unnecessary wear on your treadmill, be sure your shoes are free of any debris such as gravel and small pebbles.
- :: The device must not be used by persons weighing over 135 kg (300 lbs).

We wish you many enjoyable trainings with your new Tunturi training partner!

Profile 1:

Profile 1 level 1 (20 min)			Profile 1 level 2 (30 min)			Profile 1 level 3 (40 min)		
Min	km/h	%	min	km/h	%	min	km/h	%
0	5	0	0,0	5	0	0	5	0
1	5	0	1,5	7	0	2	6	0
2	10	0	3,0	8	1	4	8	1
3	13	0	4,5	10	1	6	8	1
4	15	1	6,0	8	2	8	6	2
5	15	1	7,5	8	2	10	6	2
6	13	0	9,0	10	1	12	8	1
7	13	0	10,5	10	1	14	8	1
8	15	3	12,0	8	4	16	6	4
9	15	3	13,5	8	4	18	6	4
10	13	1	15,0	10	2	20	8	2
11	13	1	16,5	10	2	22	8	2
12	15	5	18,0	8	6	24	6	6
13	15	5	19,5	8	6	26	6	6
14	13	3	21,0	10	4	28	8	4
15	13	3	22,5	10	4	30	8	4
16	15	4	24,0	8	3	32	6	6
17	15	4	25,5	8	3	34	6	6
18	13	0	27,0	10	0	36	8	0
19	10	0	28,5	10	0	38	8	0

Profile 2:

Profile 2 level 1 (20 min)			Profile 2 level 2 (20 min)			Profile 2 level 3 (20 min)		
Min	km/h	%	min	km/h	%	min	km/h	%
0	3,2	0	0	4,8	0	0	6,4	1
1	3,2	0	1	4,8	0	1	6,4	1
2	3,2	0	2	4,8	0	2	6,4	1
3	3,2	0	3	4,8	0	3	6,4	1
4	4,8	0	4	6,4	1	4	7,2	2
5	4,8	0	5	6,4	1	5	7,2	2
6	4,8	1	6	6,4	1	6	7,2	2
7	4,8	1	7	6,4	1	7	7,2	2
8	4,8	1	8	6,0	2	8	6,8	3
9	4,8	1	9	6,0	2	9	6,8	3
10	4,8	1	10	6,0	2	10	6,8	3
11	4,8	1	11	6,0	2	11	6,8	3
12	4,8	1	12	6,4	1	12	7,2	2
13	4,8	0	13	6,4	1	13	7,2	2
14	4,8	0	14	6,4	1	14	7,2	2
15	4,8	0	15	6,4	1	15	7,2	2
16	3,2	0	16	6,4	0	16	7,2	1
17	3,2	0	17	4,8	0	17	6,4	1
18	3,2	0	18	4,8	0	18	6,4	1
19	3,2	0	19	4,8	0	19	6,4	1

Profile 3:

Profile 3 level 1 (20 min)		Profile 3 level 2 (30 min)		Profile 3 level 3 (40 min)	
min	bpm	min	bpm	min	bpm
0	90	0,0	90	0	90
1	100	1,5	100	2	100
2	120	3,0	110	4	110
3	130	4,5	120	6	120
4	120	6,0	110	8	110
5	140	7,5	130	10	120
6	120	9,0	110	12	110
7	140	10,5	130	14	120
8	150	12,0	140	16	130
9	160	13,5	150	18	140
10	160	15,0	150	20	140
11	150	16,5	140	22	130
12	140	18,0	130	24	120
13	120	19,5	110	26	110
14	130	21,0	120	28	120
15	120	22,5	110	30	110
16	130	24,0	120	32	120
17	140	25,5	130	34	120
18	130	27,0	120	36	110
19	120	28,5	110	38	100

Profile 4:

Profile 4 level 1 (30 min)		Profile 4 level 2 (40 min)		Profile 4 level 3 (50 min)	
min	bpm	min	bpm	min	bpm
0,0	90	0	90	0,0	90
1,5	110	2	100	2,5	100
3,0	120	4	110	5,0	100
4,5	130	6	120	7,5	110
6,0	120	8	110	10,0	100
7,5	130	10	120	12,5	110
9,0	140	12	130	15,0	120
10,5	150	14	140	17,5	130
12,0	140	16	130	20,0	120
13,5	130	18	120	22,5	110
15,0	120	20	110	25,0	100
16,5	130	22	120	27,5	110
18,0	140	24	130	30,0	120
19,5	130	26	120	32,5	110
21,0	120	28	110	35,0	100
22,5	120	30	110	37,5	100
24,0	130	32	120	40,0	110
25,5	120	34	110	42,5	110
27,0	110	36	100	45,0	100
28,5	110	38	100	47,5	100

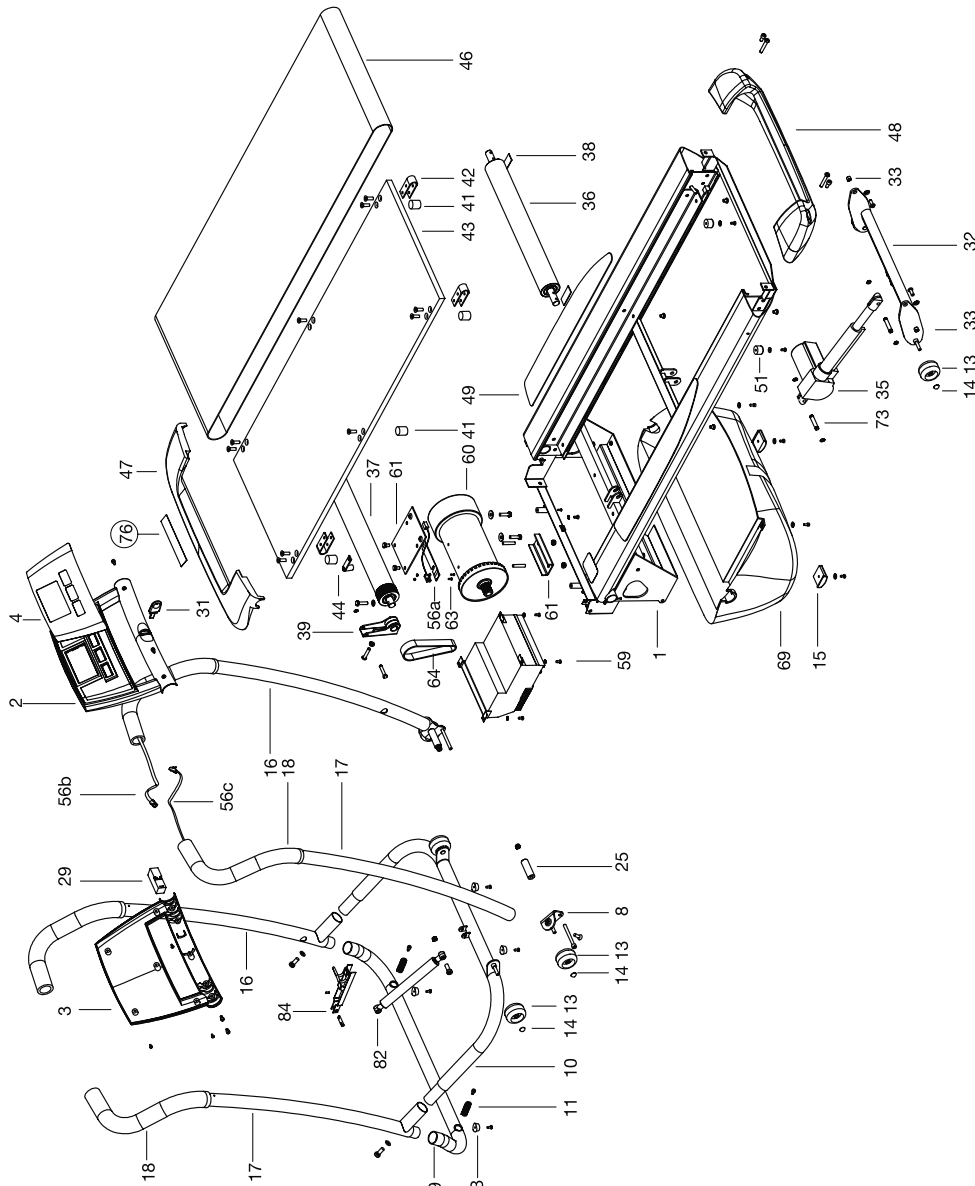

1	103 4034		A/C	56a	403 4084		D
2	233 4018	(+ 4)	A/D	56b	403 4082		D
*-	M6x12 DIN 912		C	56c	403 4083		D
3	173 4057		A	59	403 4085	(EUR)	D
-	KB 40x12 WN-1441		C	-	403 4086	(USA)	D
4	233 4020		A	-	M5 DIN 6798 I		C
* 8	543 4036	(x 2)	A/C	-	M5x14 DIN 7985		C
*-	M8x25 DIN 7991		C	-	403 4091	(EUR)	D
9	103 4037		C	-	403 4093	(USA)	D
*-	M8 DIN 137A		C	-	M4 DIN 125		C
*-	M8x80 DIN 912		C	-	KB 35x6 WN-1442		C
10	103 4035		C	-	403 470	(EUR)	D
11	643 4004		C	-	403 471	(USA)	D
-	M6x25 DIN 912		C	-	403 4090		D
13	533 1029	(2, J6)	A/C	60	813 4019		D
14	673 500 88	(2, J6)	C	-	663 4004		C
15	533 4006	(x 2)	A	-	263 4004		C
-	M5 DIN 9021		C	-	M6x8 DIN 916		C
-	M5x14 DIN 7985		C	-	303 4007		A
16	203 4023	(+ 18)	C	-	303 4006		C
-	203 4025	(+ 18)	C	-	M6x8 DIN 916		C
17	203 4024	(+ 18)	C	61	103 4031	(x 2)	C
-	203 4026	(+ 18)	C	-	M8x12 DIN 933		C
18	213 4007		A	-	M8x25 DIN 933		C
*25	523 4034	(J6)	C	-	M8 DIN 125		C
*-	M8x80 DIN 912	(J6)	C	-	M8x25 DIN 939		C
*-	M8 DIN 985	(J6)	C	-	M8 DIN 985		C
29	403 4054		D	63	503 4020		C
*31	403 4055		A	-	M3x10 DIN 7985		C
32	103 4033		C	-	M3 DIN 934		C
-	M8x20 DIN 912		C	64	443 4011		A
-	M8 DIN 125		C	69	173 4050		A
33	523 4033		C	-	M5 DIN 9021		C
35	813 4020		D	-	M5x20 DIN 7985		C
36	523 4032		A	73	343 4008		C
-	M8x50 DIN 912		C	-	10 DIN 471		C
37	523 4031		A	76	423 4059		A
-	M8 DIN 125		C	82	163 4005	(J6F)	C
-	M8x30 DIN 931		C	*-	M8x35 ISO 7380	(J6F)	C
38	533 4010		A	*-	M8 DIN 985	(J6F)	C
39	513 4002		C	84	513 4004	(J6F)	C
-	8 DIN 471		C	-	M4x10 DIN 914		C
-	M8 DIN 936		C	93	533 7025	(J6F)	A
-	M8x40 ISO 7380		C	-	M5x14 DIN 7985		C
41	533 4040	(EUR)	A/C	*	553 4013	(J6)	C
-	M8x10 ISO 7380		C	*	553 4015	(J6F)	C
-	M8x25 DIN 7991		C	*	556 031 00		C
41	533 4051	(USA)	A/C	*	556 0001		C
-	M8x10 ISO 7380		C	*	553 100	(J6)	C
42	643 4005	(USA)	C	-	583 4024		B
-	M8x10 ISO 7380		C				
-	M8x25 DIN 7991		C				
43	433 4023		E				
44	433 4026	(x 2)	C				
-	M8x14 ISO 7380		C				
46	443 4010		A				
47	173 4051		A				
-	KB 30x12 WN-1441		C				
48	173 4052		A				
-	M8x20 ISO 7380		C				
49	433 4024	(x 2)	A				
51	533 507 82		A				
-	M5 DIN 9021		C				
-	M5x14 DIN 7985		C				
52	403 4071	(EUR)	D				
-	403 4070	(USA)	D				

**List for recycling/Liste pour le recyclage/
Lista para reciclado/Informatie t.b.v. recycling**

- A :: Plastic, Thermoplast/Plastique, thermoplastique/
Plástico, termoplástico/Plastic, thermoplast
- B :: Paper, carton/Papier, carton/
Papel, cartón/Papier, karton
- C :: Metal/Métal/Metal/Metaal
- D :: Electronics/Électronique/
Componentes electrónicos/Electronica
- E :: Other/Autres/
Otros/Andere Materialen

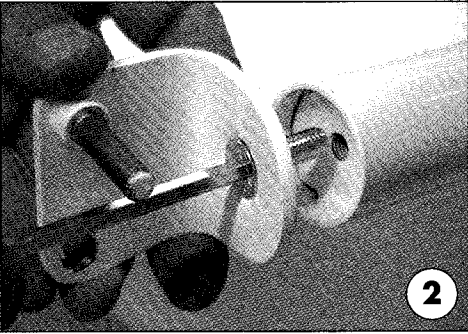

J6

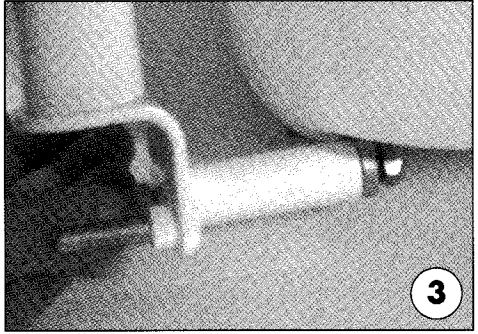

J6

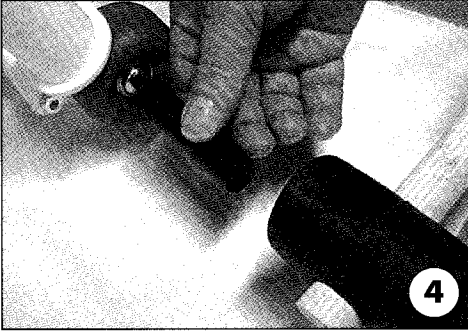

J6

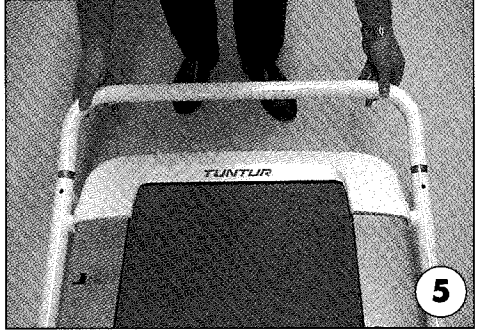

J6F

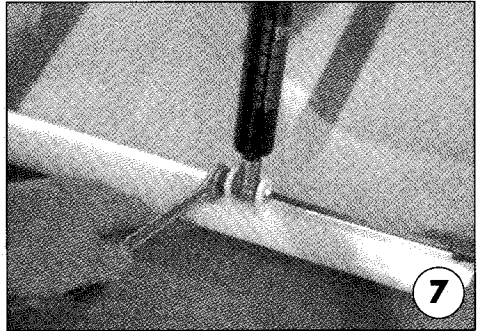

Free Manuals Download Website

<http://myh66.com>

<http://usermanuals.us>

<http://www.somanuals.com>

<http://www.4manuals.cc>

<http://www.manual-lib.com>

<http://www.404manual.com>

<http://www.luxmanual.com>

<http://aubethermostatmanual.com>

Golf course search by state

<http://golfingnear.com>

Email search by domain

<http://emailbydomain.com>

Auto manuals search

<http://auto.somanuals.com>

TV manuals search

<http://tv.somanuals.com>