

2000 SERIES CLEAR ICE MODELS CLEAR COMBO® MODELS

CLEAR ICE



U-CLR2160B-00

U-CLR2160B-40

U-CLR2160S-00

U-CLR2160S-01

U-CLR2160S-40

U-CLR2160S-41

U-CLR2160SOD-00

U-CLR2160SOD-01

U-CLR2160SOD-40

U-CLR2160SOD-41

U-CLR2160W-00

U-CLR2160W-40

CLEAR COMBO® MODELS



U-CLRCO2175B-00

U-CLRCO2175B-40

U-CLRCO2175S-00

U-CLRCO2175S-01

U-CLRCO2175S-40

U-CLRCO2175S-41

Introduction



Congratulations on your purchase of a U-Line refrigerator.

For nearly five decades and three generations, U-Line continues to be the leader in innovation, quality and value in the premium built-in undercounter ice making, refrigeration and wine preservation market. U-Line has captivated those with an appreciation for the finer things with exceptional functionality, style, inspired innovation and attention to even the smallest details. We are known and respected for our unwavering dedication to product design, quality and selection.

In 1962, Henry Uihlein founded U-Line Corporation as an outgrowth of Ben-Hur Freezer Company and was the first to develop and patent an automatic stand-alone undercounter residential ice maker. His foresight and determination to develop new ideas and to succeed when there were no clear guidelines or solutions are evident today. The newest Uihlein generation continues to build upon the family's innovative legacy at the Milwaukee, Wisconsin based business by providing continuity and vision from which new designs and technology continue to be born.

Today the complete U-Line product collection includes Ice Makers, Wine Captain® Models, Combo® Models, a Refrigerator / Freezer, Refrigerators, Drawers and Beverage Centers. The U-Line brand offers products in the 1000 Series, 2000 Series and the Modular 3000 Series. The 1000 Series offers a more targeted priced product with appropriate features, while the 2000 Series offers upscale features, advanced technology and specialized product families. U-Line's approach to its breadth of products, multiple price points and features allows a choice and product that will fit any lifestyle.

Read and save this Use and Care Guide.

NOTICE

READ all instructions in this guide completely before using the appliance for the first time.

For future reference, keep this guide in a safe, accessible location. If you need additional information or assistance, please contact U-Line Corporation direct. Contact information appears on the back cover of this guide.

Before Calling Service. If you think your U-Line product is malfunctioning, read the OPERATION section of this guide to understand clearly the function of the control. If the problem persists, read the TROUBLESHOOTING GUIDE section of this guide to help you quickly identify common problems, and provide information on possible causes and remedies.

Please Record Your Model Information

You will need your product model and serial number when you request additional information or services. You can find this information on the serial plate located on the upper right or back wall in the interior of your product. This information also appears on the warranty registration card. Please complete and mail your warranty registration card. You may also register online at www.u-line.com



Please record the model number (1), serial number (2), date of purchase, and dealer contact information for your U-Line product below:

Model Number:

Serial Number:

Purchase Date:

Dealer Name:

Dealer Address:

Dealer Telephone:

Table of Contents

Safety Precautions	
Safety Alert Definitions	1
General Precautions	1
Product Features	
Model Features:	2
Combo® Model Features:	2
Product Operation	
Air Flow	3
Initial Startup	3
Electronic Control Panel	3
Adjusting Air Temperature CLRCO2I75	3
Checking Product Temperature	4
Interior Lighting	4
Clean Alert	4
Electronic Control Quick Guide	5
Clear Ice Maker	
Clear Ice Maker Cleaning Cycle	6
Refresh Kit	7
Ice Cube Thickness Adjustment	7
Maintenance	
Leveling	8
Removing and Installing Interior Shelves	8
Light Bulb Replacement	8
Removing and Installing Grille	9
Removing and Installing Door Shelves	9
Doors (Self-Closing)	
Door Alignment and Adjustment	10
Door Reversability	10
Reversing Black or White Doors	11
Reversing Stainless Steel Glass Doors	12
Cleaning	
Exterior Cleaning	15
Interior Cleaning	15
Defrosting	15
Condenser Cleaning	16
Storage, Vacation and Moving	16
Product Disposal	16
Service	
Before Calling for Service	17
If Service is Required	17
Replacement Parts	17
Normal Operating Sounds	17
Troubleshooting Guide	17

Safety Precautions

NOTICE

- **PLEASE READ** all instructions before installing, operating, or servicing the appliance.
- Proper installation procedures must be followed when completing an installation or relocation of a unit. An **INSTALLATION GUIDE** for the unit, providing complete installation information, is available from U-Line Corporation direct. Consult the installation guide before any installation begins. U-Line contact information appears on the rear cover of this guide.
- This unit requires connection to a dedicated 15 Amp grounded (three-prong), polarized receptacle, installed by a qualified electrician, compliant with applicable electrical codes.

Safety Alert Definitions

Throughout this guide are safety items labeled with a Danger, Warning or Caution based on the risk type:

DANGER

Danger means that failure to follow this safety statement will result in severe personal injury or death.

WARNING

Warning means that failure to follow this safety statement could result in serious personal injury or death.

CAUTION

Caution means that failure to follow this safety statement may result in minor or moderate personal injury, property or equipment damage.

General Precautions

Use this appliance for its intended purpose only. Follow these general precautions with those listed throughout this guide:

DANGER

RISK OF CHILD ENTRAPMENT. Before you throw away your old refrigerator or freezer, take off the doors and leave shelves in place so children may not easily climb inside.

WARNING

SHOCK HAZARD - Electrical Grounding Required.

- Never attempt to repair or perform maintenance on the unit until the electricity has been disconnected.
- Never remove the round grounding prong from the plug and never use a two-prong grounding adapter.
- Altering, cutting of power cord, removal of power cord, removal of power plug, or direct wiring can cause serious injury, fire and or loss of property and or life, and will void the warranty.
- Never use an extension cord to connect power to the unit.
- Always keep your working area dry.

WARNING

Install provided Anti-Tip kit. Serious personal injury could occur.

CAUTION

- Use care when moving and handling the unit. Use gloves to prevent personal injury from sharp edges.
- If your model requires defrosting, **DO NOT** use an ice pick or other sharp instrument to help speed up defrosting. These instruments can puncture the inner lining or damage the cooling unit. **DO NOT** use any type of heater to defrost. Using a heater to speed up defrosting can cause personal injury and damage to the inner lining.

NOTICE

- Do not lift unit by door handle.
- Never install or operate the unit behind closed doors. Be sure front grille is free of obstruction. Obstructing free airflow can cause the unit to malfunction and will void the warranty.
- Failure to clean the condenser every six months can cause the unit to malfunction. This could void the warranty.
- Do not Block any internal Fans.

Use only genuine U-Line replacement parts. Imitation parts can damage the unit, affect its operation or performance and may void the warranty.

Product Features

Model Features:

High daily ice production and storage. The CLR2160 produces up to 60 pounds of ice per day and stores up to 30 pounds. While the CLRCO2175 can produce up to 40 pounds of ice per day and store up to 15 pounds.

Electronic control module. Automatically adjusts for changes in room and water temperatures to maximize ice production.

Digital controls. Provides an elegant interface and allows for complete control over the self cleaning process, thickness of ice cubes, and power control. The unit also provides temperature control functions for the CLRCO2175.

Easy, self-cleaning process. Both models have a simple to use self cleaning process. Within one hour all ice making internal components have been thoroughly cleaned and rinsed.

Optional 3/4" full overlay door panel. Provides a fully integrated appearance with surrounding décor while maintaining zero clearance. (Black & White models).

1/4" panel. Models will also accept a 1/4" door panel to match surrounding décor. (Black & White models)

Flexible water drain options. Water may be drained using either a gravity fed drain or a U-Line supplied P60 drain pump.

Built in or freestanding. Provides custom look, no additional clearance needed around top, rear or sides of unit.

Stainless steel model. Offers a stainless door along with a commercial stainless door handle. Outdoor models also include a stainless cabinet.

Self-closing door. Engages when door is open 8"-10" and ensures a positive door seal. Also prevents door bounce back.

Field reversible doors. Flexible installation options. Allows your unit to be installed almost anywhere. (Black & White models).

Integrated handle. Sleek designer look that does not add depth to the cabinet when built in (Black & White models).

Vinyl-clad cabinets. Textured, rich look. More resistant to scratching, peeling and flaking. (Black, White & Stainless Indoor models).

Leveling legs. Provides a more precise under counter fit. Durable and factory installed.

Sabbath or "Black Out" mode. Easily turn off all lights and control display until manually reset.

Contemporary grille design. Integrates and accents surrounding décor.

LED illumination. Provides efficient and elegant lighting to the interior of your unit. Automatically illuminates when door is open (CLR2160 indoor models only).

Combo® Model Features:

Clear ice production capability plus refrigeration all in one unit. Both clear ice capability and refrigeration all in on 24" wide compact unit.

Three glass shelves. Maximizes storage capacity and easy to clean.

Two adjustable in-door storage shelves. Provides easy access to commonly used product. Allows for flexible storage options.

Recessed interior light. Located in the refrigerator, this light automatically illuminates when the door is open.

Product Operation

Air Flow

NOTICE

The unit requires proper air flow to perform at its highest efficiency. Do not block the front grille or internal fans at any time, or the unit will not perform as expected. Do not install the unit behind a door.

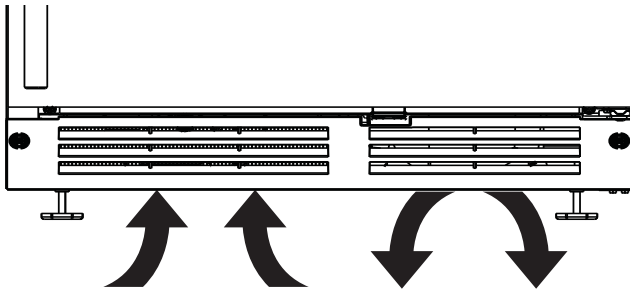

Initial Startup

All U-Line controls are preset at the factory. Initial startup requires no adjustments.

NOTICE

U-Line recommends allowing the unit to run overnight before loading refrigerator or freezer with product.

To turn the unit on or off, press and hold the POWER icon (1) for about ten seconds and release. The display will show the unit set-point temperature on Combo models, and ICE on Clear Ice models when turned on and display "OFF" when the unit is off.

Electronic Control Panel

Digital Display. The electronic control with digital display on Combo models shows a single continuous set-point temperature, or on Clear Ice models it shows "ICE". The set point is for the middle zone, it is a base number used by the controller to maintain the multiple temperature zones in the unit. The factory default set-point for Refrigerator models is 38°F. The set-point temperature is a gauge for further temperature adjustments.

Adjusting Air Temperature CLRCO2175

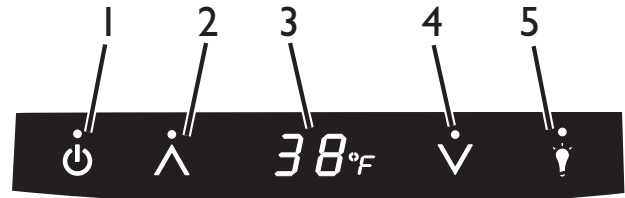

NOTICE

Adjust the set point temperature in single increments, and wait 24 hours for the temperature to stabilize before rechecking.





Note: The CLRCO2175 refrigerator zone temperature is adjustable. The ice storage bin temperature in the CLRCO2175 or CLR2160 is not adjustable.

To adjust the set point temperature:



1. Press and release either WARMER  (2) or COOLER  (4) to put the controller in the SET TEMPERATURE mode. The display (3) will begin to flash the °F (or °C) symbol.

NOTE: This mode will self-cancel in five seconds, and the display (3) will show the original set point temperature.

2. Within five seconds (while the °F (or °C) symbol is flashing), press WARMER  or COOLER  as required to adjust the set point temperature.
3. The change sets five seconds after adjusting the temperature, and the display (3) will show the new set point temperature.

Temperature °F °C Selection. U-Line products supplied for 110 VAC have temperatures displayed (3) by default in Fahrenheit (°F). Models supplied for 220 VAC have temperatures displayed (3) by default in Celsius (°C).

Easily adjust the display for either type temperature display.

1. Press and hold LIGHT  (1) and simultaneously within five seconds press COOLER  (5) three times to change the display (3) as needed.

Temperature Display. The digital display shows set-point, air temperature. Under normal operating conditions the temperature will fluctuate based on a number of factors including door openings, product load, room temperature, and humidity. The temperature will always be cool toward the top and coolest toward the bottom.

To display actual temperature:

1. Press WARMER  (2) for five seconds. The display (3) will indicate the actual temperature.
2. After about 10 seconds, the set point temperature will return to the display.

Checking Product Temperature

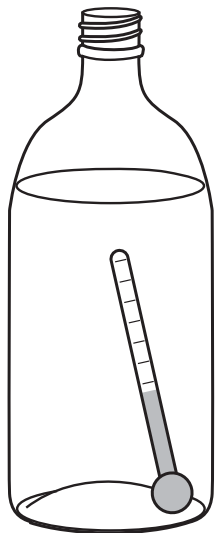

To check the actual product temperature in the unit.

1. Partially fill a plastic (nonbreakable) bottle with water.
2. Insert an accurate thermometer.
3. Tighten the bottle cap securely.
4. Place the bottle in the desired area for 24 hours.
5. Avoid opening the unit during the testing period.
6. After 24 hours, check the temperature of the water. If required, adjust the temperature control in a small increment (See ADJUSTING TEMPERATURE).

Causes which affect the internal temperatures of the cabinet include:

- Temperature setting.
- Ambient temperature where installed.
- Installation in direct sunlight or near a heat source.
- The number of door openings and the time the door is open.
- The time the internal light is illuminated. This mainly affects product on the top rack or shelf.
- The front grille or condenser are obstructed.

Interior Lighting

Normal Operation. Opening the door will cause the interior of the cabinet to illuminate.

Use LIGHT  (5) on the control panel to change the lighting functions.

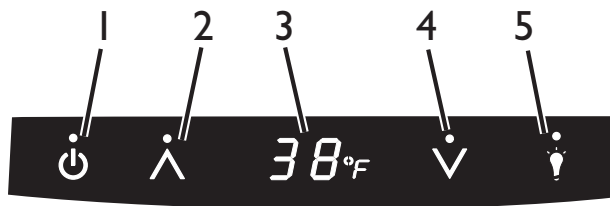

Blackout (Sabbath) Mode. The interior of the cabinet and control display remains darkened until reset. Blackout (Sabbath) Mode is not Star K certified.

To turn the lights and display OFF:

1. Press and hold LIGHT  (5) for ten seconds and release (the °F symbol will flash briefly at the end of the ten second period).
2. The interior light and control display (3) will go dark until the mode is reset.
3. NOTE: Although the display will not be visible, the temperature controls in the unit remain active, and preserve the interior temperature.

















To exit the Blackout (Sabbath) Mode, repeat Step 1.























Clean Alert

Operation of the unit is continuously monitored by the electronic control. The unit will automatically notify the user that the units internal components require cleaning. When the alert is issued "CL" will appear on the control display. For more information on cleaning your ice maker see page 6.

Note: The clean alert can be temporarily dismissed by touching any key on the display.

Electronic Control Quick Guide

Task	Touch	Touch	Display	Comment
Turn ON/OFF	 Hold 5 seconds	Release when °F flashes.	 or 	
Adjust Temperature CLRCO2175	 or  Touch and release	 or  Touch to change temperature		°F flashes after first touch, set-point saved after 5 seconds of inactivity and °F stops flashing.
View Actual Temp CLRCO2175	 Hold 5 seconds	Release when °F flashes.		WC models will scroll top/mid/bottom temps.
Change F/C CLRCO2175	 Hold	  	 or 	
Blackout Mode	 Hold 10 seconds		Display (and cabinet light) will not operate in Blackout Mode.	Blackout will end in 36 hours, or hold again to terminate early.

Clear Ice & Clear ice Combo				
Clean Cycle		  		Will automatically return to ice production when clean cycle is complete
Ice Thickness Adjustment		  		Use warmer/colder to scroll.
Temporary Shutdown (Office Mode)		  		Ice maker will automatically turn back on in three hours.
Combo Ice Maker Off		  	  	Repeat to switch back

NOTE: 38°F is an example; the display will vary with actual set-point.

Clear Ice Maker

Clear Ice Maker Cleaning Cycle

Units with a serial number beginning with an 09 or greater have an automatic clean alert function. Cleaning cycles should be run as notified. Otherwise, To maintain operational efficiency the unit should be cleaned every three months. Depending on water conditions, more frequent cleaning may be necessary. If the ice maker requires more frequent cleaning, consult a plumber to test the water quality and recommend appropriate treatment.

CAUTION

Wear rubber gloves and safety goggles and/or face shield when handling Ice Machine Cleaner.

NOTICE

Use only U-Line Ice Machine Cleaner (Part No. 37050, available from your dealer or direct from your local parts distributor. To locate a parts distributor near you, visit www.U-LineService.com. It is a violation of federal law to use this solution in a manner inconsistent with its labeling. Use of any other cleaner can ruin the finish of the evaporator and will void the warranty. Read and understand all labels printed on the package before use.

U-Line Ice Machine Cleaner is used to remove lime scale and other mineral deposits. Refer to the following steps to initiate the self-cleaning cycle.

NOTICE

- **Model CLRCO2175 refrigerator will not operate during the ice maker cleaning cycle. Remove all fresh food to prevent spoilage.**
- **Model CLRCO2175 ice production after the first harvest may take longer after the cleaning cycle since restoring the refrigerator temperature will take precedence over ice production. Once the refrigerator reaches its set-point temperature, ice making will resume.**

CAUTION

Never use anything to force ice from the evaporator. Damage may result.

1. Turn the ice maker off and allow any ice to melt off of the evaporator.
2. Remove all ice from the storage bin.
3. Remove evaporator cover.
4. Remove the standpipe by lifting it up while using a slight back and forth motion to loosen it from the drain hole. The water in the reservoir will flow down the drain.

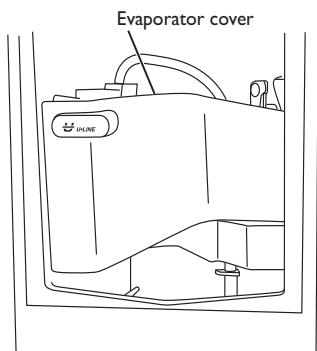

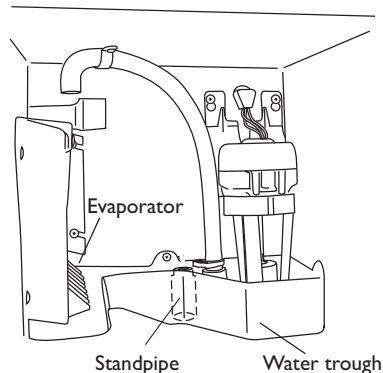

5. Re-install the standpipe into the water trough.

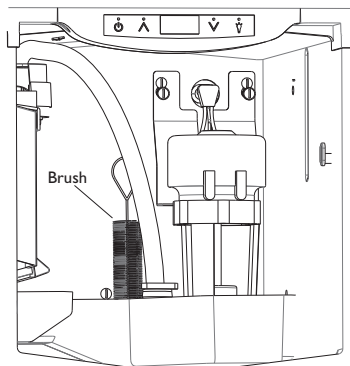

6. Clean the Interior Bin as follows:
 - Dilute one packet of CLR cleaner into two quarts of water.
 - Using a sponge or cloth, clean interior of ice bin, tubing and door. This cleaner will remove all mineral deposits and other contaminants from the surfaces.
 - Using a bottle brush, clean out the trough drain tube and pump tubing where needed.



7. Turn unit on by touching POWER .
8. Place the unit into CLEAN mode by holding POWER  while pressing LIGHT  three times.
9. When water begins flowing over the evaporator (approximately 3 minutes), pour 1 packet of CLR cleaner into the water trough. The cleaning process will last approximately 45 minutes.
10. Dilute 1 tablespoon bleach in 1 gallon of warm water. Apply this solution to the entire inside of the storage area. Then rinse thoroughly with water.

The unit will resume operation approximately 15 minutes after the automated cleaning process is completed. The water fill valve will energize, fill the water reservoir, and shut-off after three minutes. The compressor begins to operate and water flows over the evaporator assembly (ice mold). Initially, the water flow may not be uniform, causing uneven sized cubes or water to spill into the ice storage bin. This is a normal situation that will correct itself within the first 24 hours of operation.

NOTICE

- Discard all ice produced in the first harvest.
- Should power to the unit be interrupted during the self-clean cycle, it will be necessary to repeat the complete cleaning cycle after power is restored.

Refresh Kit

Due to variations in water quality or inadequate maintenance your unit may become excessively coated in lime scale or calcium. U-Line offers a cost effective refresh kit which replaces many interior components and will return your unit to like new condition. Refresh kits may be ordered from your local distributor and installed by your local service company. For information on your local distributor or service company please visit <http://www.u-lineservice.com>.





Refresh Kit Part Number

Model	Part Number
CLR2160	80-51003-00
CLRCO2175	80-51002-00

Ice Cube Thickness Adjustment

Interval - As Required

Ice thickness adjustments are made using the control panel as follows:

1. To enter the thickness adjustment mode:
 - Touch and hold WARMER .
 - Touch and release COOLER  three times, then release WARMER .
 - The display will switch to "0" to confirm the thickness adjustment mode has been selected.
2. The factory setting is "0," and the total range of adjustment is -5 to +5 (ideal range is -1 to +1). Use WARMER  to raise the setting and thicken the ice bridge, or COOLER  to lower the setting to thin the ice bridge.

NOTICE

Ice thickness adjustment should only be made one increment at a time. Allow ice maker production to stabilize for 24 hours before rechecking ice thickness.

3. Touch and release the LIGHT button key to exit the ice thickness adjustment mode.
4. Remove all ice from the storage bin.

Ice cubes in any given batch will vary, so it is necessary to choose cubes from the sample area for comparison when making adjustments. If further adjustments are desired, repeat Steps 1 through 4.

The ice cube thickness is factory set for best overall performance. The factory setting is designed to maintain an ice bridge of approximately 1/16" to 1/8" under normal conditions, resulting in a dimple of approximately 1/4" to 1/2" in depth. A fuller cube with less of a dimple results in a thicker ice bridge. As the ice bridge becomes thicker, the tendency for the cubes to stay together as a slab increases. A bridge thicker than 1/8" may cause cubes to overfill the ice bucket.

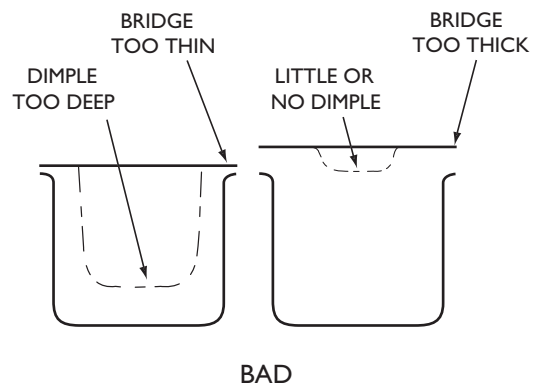
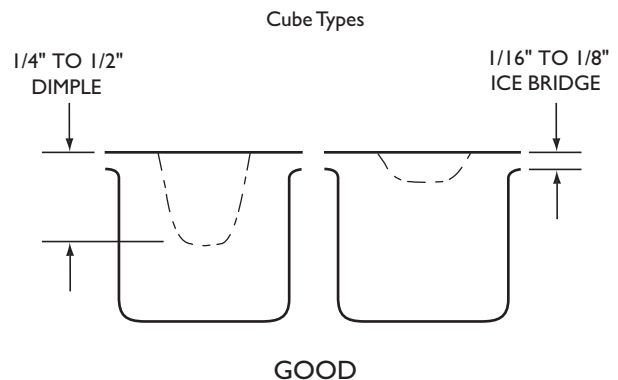
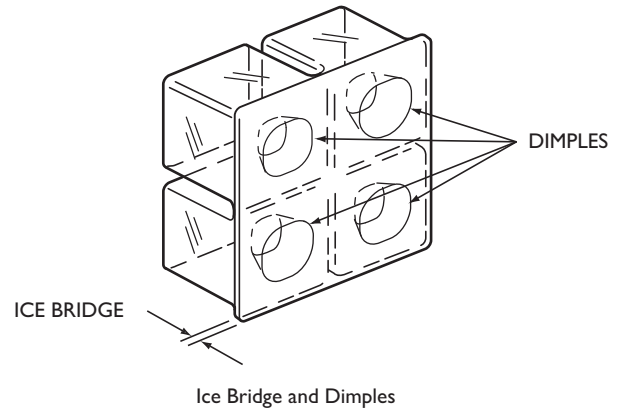

Maintenance

Leveling

NOTICE

Unit must be level, for proper door and ice maker (if equipped) operation.

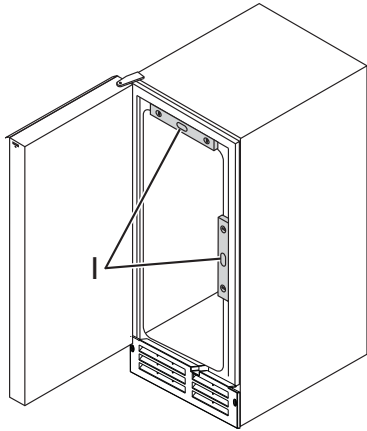

For Models with adjustable leveling feet:

1. Use a level to check the levelness of the unit from front to back and from side to side. Place the level along top edge and side edge as shown (1).
2. If the unit is not level, rotate the adjustable leveling legs to raise or lower each corner of the unit as necessary.
3. Check levelness after each adjustment and repeat the previous steps until the unit is level.

For Models without adjustable leveling feet:

NOTICE

The unit must be located on a level surface, for proper door and ice maker (if equipped) operation.

Use a level to check the levelness of the unit from front to back and from side to side. Place the level along top edge and side edge as shown (1).

Removing and Installing Interior Shelves

1. Pull shelf out about 6" until back of shelf clears the "hump" on the right-hand side.
2. Tilt right-hand edge of shelf up. Remove shelf from unit by pulling out.

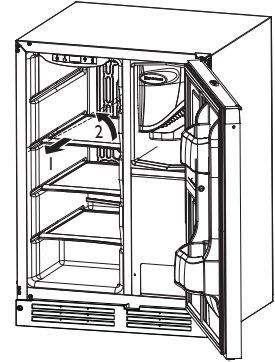

Insert the shelves as follows:

1. To move to a different position in the unit, insert shelf at an angle, approximately 15°-20° over the rib in the side of the unit where you want to place the shelf. The shelf must be started into the unit at an angle to clear the door.
2. Continue to slide the shelf into the unit at an angle until free.
3. Lower the shelf and push it in completely.

Light Bulb Replacement

CLRCO2175 Only

To replace the light bulb in your U-Line unit:

1. Find the light located at the top of the unit. Grasp the edges of the light housing lens (1), opposite the exposed tab, and gently push the lens toward the tab (2).
2. Pull the edge of the lens down (1) and swing it out of the light housing.

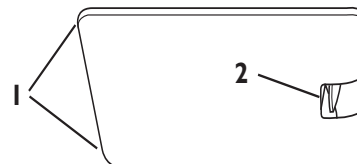

NOTICE

ALWAYS use a genuine U-Line replacement 120V 10 watt bulb (Part Number 31317) in the light housing. Use of any other bulb within the housing will produce excessive heat, causing damage to the light housing and cabinet interior, and will compromise the precise temperature control of the unit.

3. Replace the lens by first inserting the tab side back into the housing at a slight angle.
4. While gently pushing the lens towards the tab end, push the free end into the housing, and release when you hear a snap.

Removing and Installing Grille

⚠ WARNING

Disconnect electric power to the unit before removing the grille.

⚠ WARNING

DO NOT touch the condenser fins (4). The condenser fins are **SHARP** and can be easily damaged.

Removing the grille.

1. Disconnect power to the unit.
2. Loosen the two screws (1).
3. Remove grille (2) from unit.

Installing the grille:

1. Place the hook-hinge located on the rear bottom side of the grille (2) onto the front lip of the unit base. Swing the grille up into position.
2. Align cabinet and grill holes and secure, but do not overtighten grille screws (1).
3. Reconnect power to the unit.

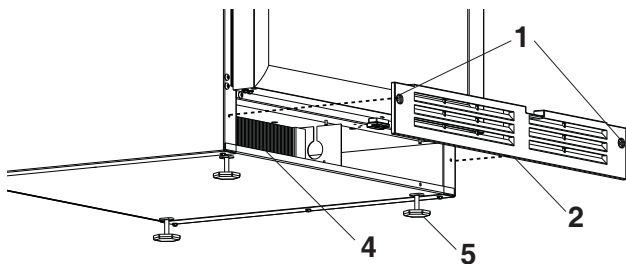

Typical Model Shown

Removing and Installing Door Shelves

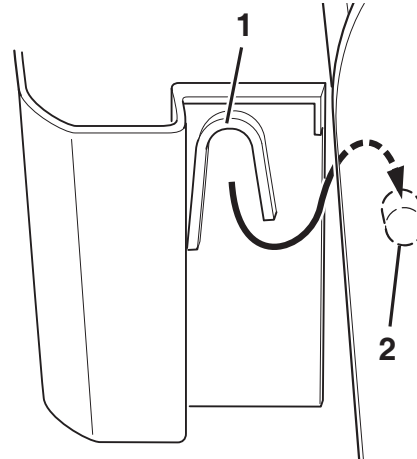

For models equipped with door shelves:

To remove the door shelf:

1. Grasp shelf in center, and lift until the shelf notches (1) clear the pins (2).
2. Carefully pull the shelf away from the door.

To install the door shelf:

1. Holding the shelf in the center, center the shelf in the door at the desired location, slightly above the pins (2).
2. Lower the shelf onto the pins (2).

Doors (Self-Closing)

Door Alignment and Adjustment

Align and adjust the door if it is not level, or is not sealing properly. If the door is not sealed the unit may not cool properly, or excessive frost may form in the interior.

NOTICE

- Properly aligned, the door's gasket should be firmly in contact with the cabinet all the way around the door (no gaps). Carefully examine the door's gasket to ensure that it is firmly in contact with the cabinet. Also make sure the door gasket is not pinched on the hinge side of the door.
- The door will not be flush with the top of the cabinet. The top edge of the door will be 1/8 in. (3.175 mm) below the cabinet top.

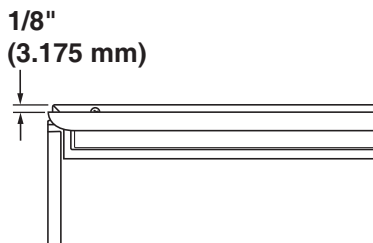

To align and adjust the door:

1. Compare the top edge of the door (opposite the hinges) to the top edge of the cabinet and note the type (up or down) of adjustment needed.

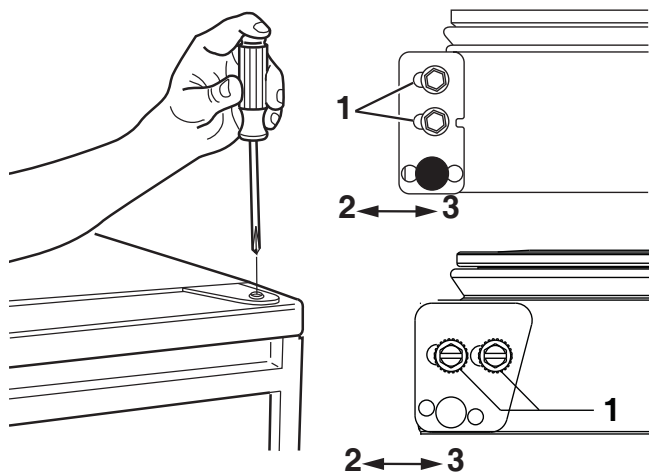

2. Remove the top hinge pivot pin with a Phillips screwdriver and lift door off bottom hinge pin. Be careful not to lose the door closer insert sets.
3. Turn the door upside down and inspect the hinge plate mounting holes. The plate has slotted mounting holes. Loosen but do not remove the two hinge plate screws (1).
4. If door edge opposite the hinges needs to move up, move plate toward outside of door (2). If door edge needs to move down, move plate toward inside of door (3). Repeat until top edge of

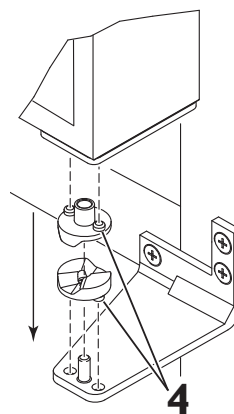

door is parallel with top of cabinet and tighten screws (1) securely.

5. After adjustment is complete, remove the door closers from the bottom hinge, clean thoroughly and apply petroleum jelly to the mating surfaces of the closers. Be sure that pins on closers align with holes in the door and bottom cabinet hinge plates. Mount door and install top hinge pivot pin.

Door Reversability

Location of the unit may make it desirable to mount the door on the opposite side of the cabinet. Many doors are reversible. See table below.

Model	Reverse	Model	Reverse
U-2115RB-00	YES	U-2175WCCOL-02	YES
U-2115RS-00	NO	U-2175WCCOL-60	YES
U-2115RS-01	NO	U-2175WCCS-00	YES
U-2115RS-02	NO	U-2175WCCS-02	YES
U-2115RSOD-00	NO	U-2175WCCS-13	YES
U-2115RSOD-01	NO	U-2175WCCS-22	YES
U-2115RW-00	YES	U-CLR2160B-00	YES
U-2115WCOL-00	YES	U-CLR2160B-40	YES
U-2115WCS-00	YES	U-CLR2160S-00	NO
U-2175BEVCOL-00	YES	U-CLR2160S-01	NO
U-2175BEVCOL-02	YES	U-CLR21060S-40	NO
U-2175BEVCOL-60	YES	U-CLR2160S-41	NO
U-2175BEVCS-00	YES	U-CLR2160SOD-00	NO
U-2175BEVCS-02	YES	U-CLR2160SOD-01	NO
U-2175RCB-00	YES	U-CLR2160SOD-40	NO
U-2175RCB-02	YES	U-CLR2160SOD-41	NO
U-2175RCGOL-00	YES	U-CLR2160W-00	YES
U-2175RCGS-00	YES	U-CLR2160W-40	YES
U-2175RCS-00	NO	U-CLR2175B-00	YES
U-2175RCS-01	NO	U-CLR2175B-40	YES
U-2175RCS-22	NO	U-CLR2175S-00	NO
U-2175RCW-00	YES	U-CLR2175S-01	NO
U-2175RFB-00	YES	U-CLR2175S-40	NO
U-2175RFS-00	NO	U-CLR2175S-41	NO
U-2175RFS-01	NO	U-CO2175FB-00	YES
U-2175RFW-00	YES	U-CO2175FS-00	NO
U-2175RSOD-00	NO	U-CO2175FS-01	NO
U-2175RSOD-01	NO	U-CO2175FW-00	YES
U-2175WCCOL-00	YES		

Reversing Black or White Doors

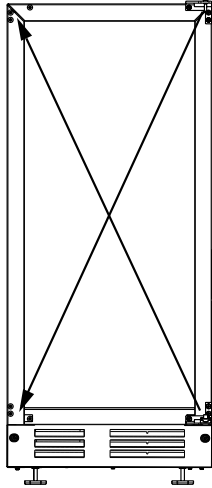

- The hinge hardware will be removed and reinstalled on the opposite side of the cabinet.
- The top hinge hardware will be reinstalled on the bottom of the opposite side of the cabinet.
- The bottom hinge hardware will be reinstalled on the top of the opposite side of the cabinet.

Remove Door

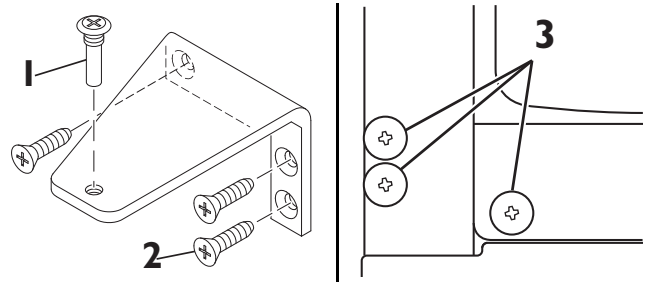

1. Hold door to keep it from falling.
2. Remove hinge screw pin (1) from top hinge using a Phillips screwdriver.
3. Remove door by tilting forward and lifting door off bottom hinge closer inserts.
4. Reinstall hinge screw pin (1) into top hinge using a Phillips screwdriver.

Remove hole plugs.

Remove plastic screw plugs (three each, top and bottom) (3) from new hinge location. Save for reinstallation later.

Remove existing top hinge.

Remove existing top hinge (three screws) (2).

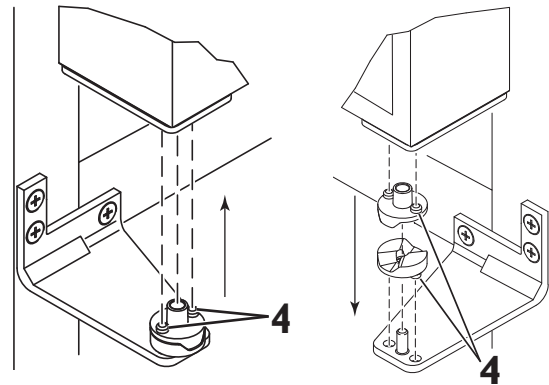

Reinstall hinge to bottom opposite.

1. Install the hinge just removed from the top to the **BOTTOM** opposite side of the cabinet (three screws) (2).
2. Remove the two door closer inserts (4) from the existing bottom hinge.
3. Install door closer inserts as shown on the new bottom hinge (4).

Remove preexisting bottom hinge.

1. Remove the preexisting bottom hinge (three screws) (2).

Reinstall hinge to top opposite.

1. Install the hinge just removed from the bottom to the TOP opposite side of the cabinet (three screws) (2).

Reinstall Hole Plugs.

1. Install plastic screw plugs (three each, top and bottom) (3) into holes where hinge hardware was removed.

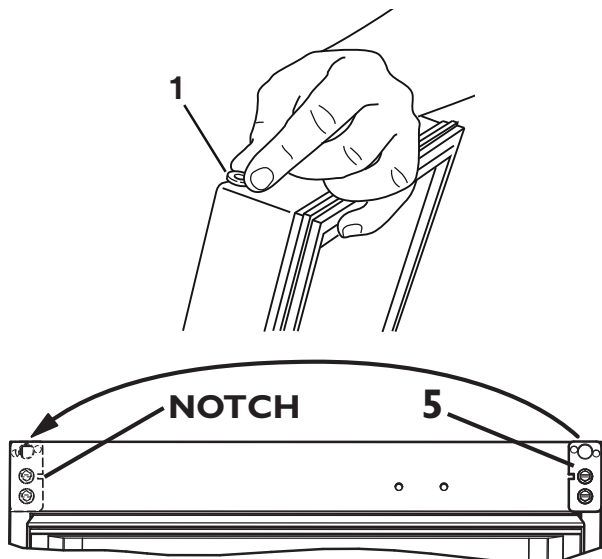

Prepare door for reinstallation.

1. Remove plastic hole plug from top of door handle and reinstall on opposite side.
2. With bottom of door facing up, remove pivot plate (5) (two screws).
3. Flip over and install pivot plate on opposite side of door. Ensure notch in plate faces center.

Install Door.

1. Hold door upright and tilted forward.
2. Lift door on to bottom hinge closer inserts.
3. Tilt door forward into position.
4. Hold door to keep it from falling.
5. Reinstall hinge screw pin (1) into top hinge using a Phillips screwdriver.

Align and adjust the door:

Align and adjust the door, see DOOR ALIGNMENT AND ADJUSTMENT on page 10.

Reversing Stainless Steel Glass Doors

Remove Door

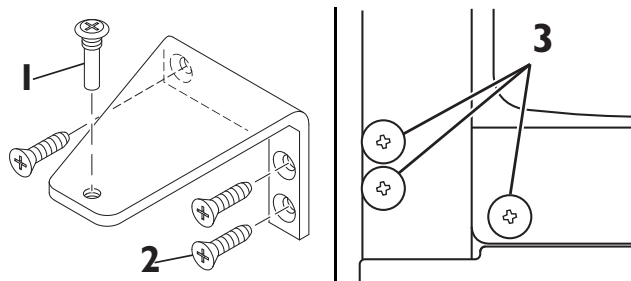

1. Hold door to keep it from falling.
2. Remove hinge screw pin (1) from top hinge using a Phillips screwdriver.
3. Remove door by tilting forward and lifting door off bottom hinge closer inserts.
4. Reinstall hinge screw pin (1) into top hinge using a Phillips screwdriver.

Remove hole plugs.

1. Remove plastic screw plugs from (three each, top and bottom) (3) from new hinge location. Save for reinstallation later.

Remove Stainless Frame

1. Remove two screws from top of door. Save screws for later installation.

Top Of Door

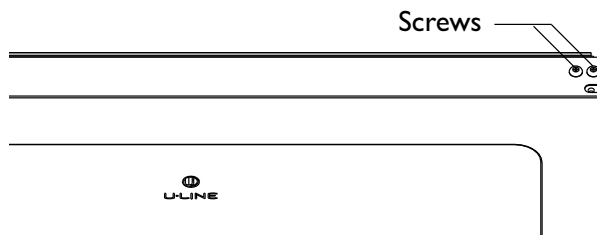

2. Remove pivot plate from bottom of door by removing 2 screws. Set pivot plate and screws aside for later installation.

Bottom Of Door

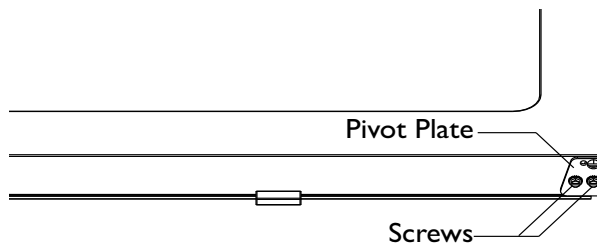

3. Grasp outer edge of stainless frame and firmly press inside edge of glass in while pulling stainless frame in opposite direction.

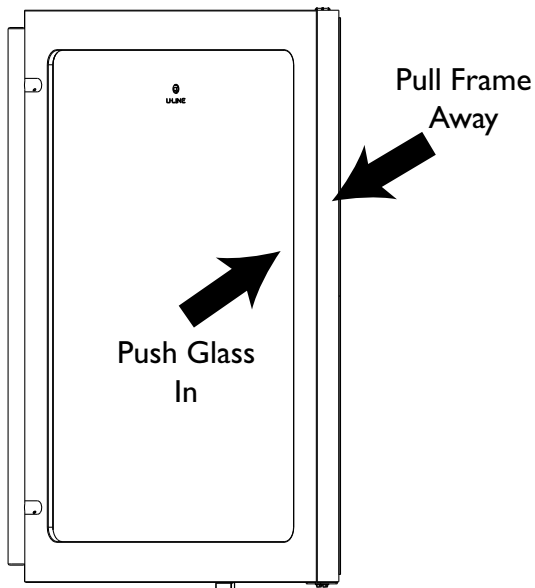

4. Unhinge frame from door.

Assemble Stainless Frame

1. Prop frame against solid surface, handle side down and away
2. Insert door, logo forward, into frame at a 30° angle. For a right hand hinge the logo should be to your right. For a left hand hinge the logo should be to your left.

Door Orientation Right Hand Hinge

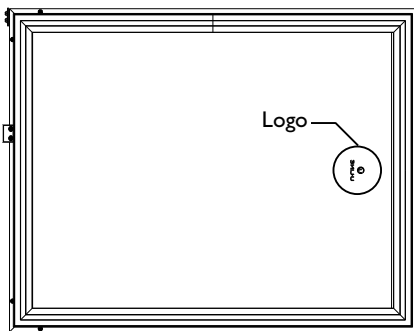

Door Orientation Left Hand Hinge

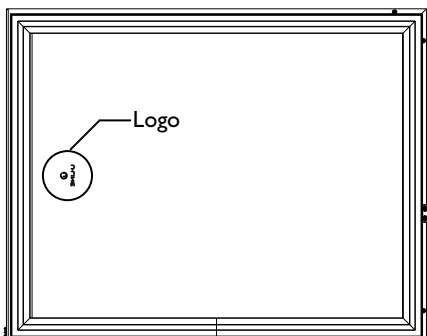

3. Swing door into frame.
4. Install screws removed in "Remove Stainless Frame" step 1 to top of door, opposite handle.
5. Install pivot plate to bottom of door, opposite of handle, using hardware removed in "Remove Stainless Frame" step 2. Arrange pivot plate so the flat edge is against the edge of the door.

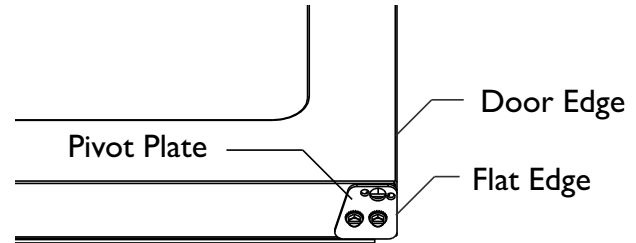

Orient Hinge

1. Remove existing top hinge (three screws) (2).

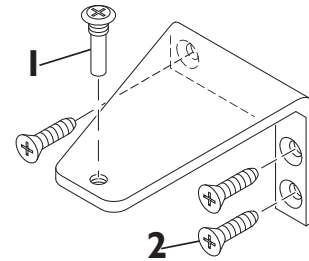

Reinstall hinge to bottom opposite.

1. Install the hinge just removed from the top to the BOTTOM opposite side of the cabinet (three screws) (2).
2. Remove the two door closer inserts (4) from the preexisting bottom hinge.

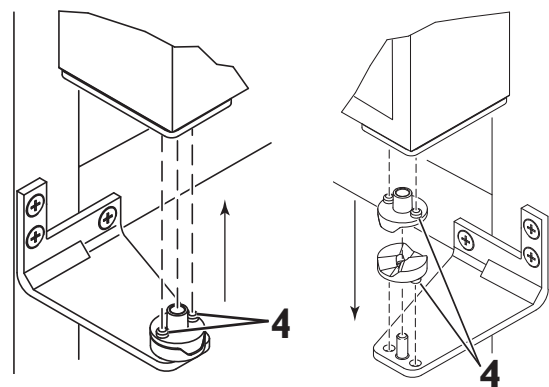

3. Install door closer inserts as shown on the new bottom hinge (4).

Remove existing bottom hinge.

1. Remove the existing bottom hinge (three screws) (2).

Reinstall hinge to top opposite.

1. Install the hinge just removed from the bottom to the TOP opposite side of the cabinet (three screws) (2).

Reinstall Hole Plugs.

1. Install plastic screw plugs (three each, top and bottom) (3) into holes where hinge hardware was removed.

Install Door.

1. Hold door upright and tilted forward.
2. Lift door on to bottom hinge closer inserts.
3. Tilt door forward into position.
4. Hold door to keep it from falling.
5. Reinstall hinge screw pin (1) into top hinge using a Phillips screwdriver.

Align and adjust the door:

Align and adjust the door, see DOOR ALIGNMENT AND ADJUSTMENT on page 10.

Cleaning

Exterior Cleaning

Vinyl Clad (Black or White) Models:

- Clean surfaces with a mild detergent and warm water solution. Do not use solvent-based or abrasive cleaners. Use a soft sponge and rinse with clean water. Wipe with a soft, clean towel to prevent water spotting.
- Clean any glass surfaces with a non-chlorine glass cleaner.

Stainless Models:

- Stainless door panels, handles and frames can discolor when exposed to chlorine gas, pool chemicals, saltwater or cleaners with bleach.
- Keep your stainless unit looking new by cleaning with a good quality all-in-one stainless steel cleaner polish monthly. For best results use Claire® Stainless Steel Polish and Cleaner, which can be purchased from U-Line Corporation (Part Number 173348). Comparable products are acceptable. Frequent cleaning will remove surface contamination that could lead to rust. Some installations may require cleaning weekly.
- **Do not clean with steel wool pads.**
- **Do not use stainless steel cleaners polishes on any glass surfaces.**
- Clean any glass surfaces with a non-chlorine glass cleaner.
- **Do not use cleaners not specifically intended for stainless steel on stainless surfaces (this includes glass, tile and counter cleaners).**
- If any surface discoloring or rusting appears, clean it quickly with Bon-Ami® or Barkeepers Friend Cleanser® and a nonabrasive cloth. Always clean towards the grain. Always finish with Claire Stainless Steel Polish and Cleaner or comparable product to prevent further problems.
- **Using abrasive pads such as ScotchBrite™ will cause the graining in the stainless to become blurred.**
- Rust not cleaned up promptly can penetrate the surface of the stainless steel and complete removal of the rust may not be possible.

Interior Cleaning

- **Disconnect power to the unit.**
- Clean the interior and all removed components using a mild nonabrasive detergent and warm water solution applied with a soft sponge or non-abrasive cloth.
- Rinse the interior using a soft sponge and clean water.
- **Do not use any solvent-based or abrasive cleaners.** These types of cleaners may transfer taste and/or odor to the interior products and damage or discolor the interior.

Defrosting

Automatic Defrost Models

Frost on the rear wall is normal and will melt during each off cycle. If there is excessive build-up of 1/4" or more, manually defrost the unit.

- Ensure the door is closing and sealing properly.
- High ambient temperature and excessive humidity can also produce frost.

CAUTION

DO NOT use an ice pick or other sharp instrument to help speed up defrosting. These instruments can puncture the inner lining or damage the cooling unit. DO NOT use any type of heater to defrost. Using a heater to speed up defrosting can cause personal injury and damage to the inner lining.

NOTICE

The drain pan was not designed to capture the water created when manually defrosting. To prevent water from overflowing the drain pan, place towels or other absorbent materials over the interior drain trough, under the evaporator (1), before defrosting.

To defrost:

1. **Disconnect power to the unit.**
2. For combo models remove all products from the interior.
3. Place towel or other absorbent material on bottom of ice bin. For combo models, also place in bottom of unit.

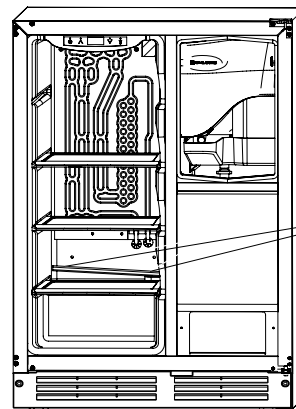

Place towels or absorbent materials over the interior drain trough

4. Prop the door in an open position (2 in. (5cm) minimum).
5. Allow the frost to melt naturally.
6. After the frost melts completely clean the interior and all removed components. (See INTERIOR CLEANING)
7. When the interior is dry, reconnect power and turn unit on.

NOTE: To safeguard against contaminants in ice, discard first three batches of ice after defrosting.

Condenser Cleaning

Interval - Every Three Months

To maintain operational efficiency, keep the front grille free of dust and lint, and clean the condenser every three months. Depending on environmental conditions, more or less frequent cleaning may be necessary.

WARNING

Disconnect electric power to the unit before cleaning the condenser.

WARNING

DO NOT touch the condenser fins. The condenser fins are **SHARP** and can be easily damaged.

NOTICE

DO NOT use any type of cleaner on the condenser unit.

1. Remove the grill. (See MAINTENANCE)
2. Clean the condenser coil (4) using a using a soft brush with a “combing” action or vacuum cleaner. Do not touch the condenser coil.
3. Install the grill. (See MAINTENANCE)

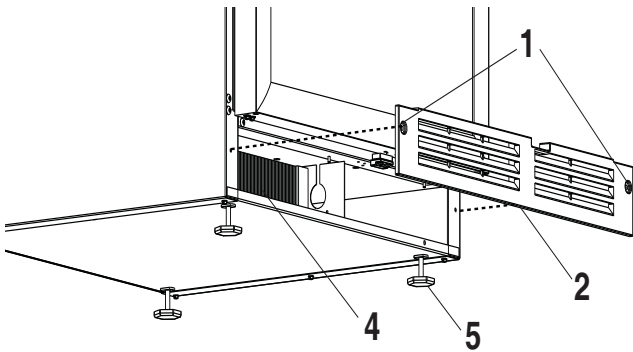

Storage, Vacation and Moving

If not using the unit for an extended period, or otherwise stored, follow these steps completely:

WARNING

Electrical Shock Hazard. Disconnect power before servicing. Before operating, replace all panels. Failure to do so may result in death or electrical shock.

NOTICE

If the ambient temperature is expected to drop below 50°F, turn off and unplug unit, and drain all water from the unit to prevent freezing damage not covered by the warranty.

1. Remove all consumable contents from the unit.
2. Disconnect the power cord from its outlet, and leave it disconnected until the unit is returned to service.
3. Clean and dry the interior of the cabinet.
4. During periods of nonuse, the cabinet must remain open to prevent formation of mold and mildew. Open door a minimum of 2 in. (5 cm) to provide the necessary ventilation.

Product Disposal

If the unit is being removed from service for disposal, check and obey all Federal, State and or Local regulations regarding the disposal and recycling of refrigeration appliances, and follow these steps completely:

1. Remove all consumable contents from the unit.
2. Disconnect power to the unit and unplug the power cord from its outlet.

DANGER

RISK OF CHILD ENTRAPMENT. Before you throw away your old refrigerator or freezer, take off the doors and leave shelves in place so children may not easily climb inside.

3. Remove the cabinet door.

Before Calling for Service

If you think your U-Line product is malfunctioning, read the OPERATION section of this guide to clearly understand the function of the control.

If the problem persists, read the NORMAL OPERATING SOUNDS and TROUBLESHOOTING GUIDE section of this guide to help you quickly identify common problems, and possible causes and remedies. Most often, this will resolve the problem without the need to call for service.

If Service is Required

If you do not understand a troubleshooting remedy, or your product needs service, contact U-Line Corporation directly. Contact information appears on the rear cover of this guide.

When you call, you will need your product Model and Serial Numbers. This information can be recorded inside the front cover of this guide. It also appears on the Model and Serial number plate located on the upper right or rear wall of the interior of your product.

Replacement Parts

When you need replacement parts, always request genuine U-Line replacements. U-Line designs and engineers products using components that work efficiently, and provide superior service life and performance. The use of aftermarket parts or components may affect the safety, operation, performance or durability of your product, and may also void its warranty.

Normal Operating Sounds

All models incorporate rigid foam insulated cabinets to provide high thermal efficiency and maximum sound reduction for its internal working components. Despite this technology, your model may make sounds that are unfamiliar.

Normal operating sounds may be more noticeable because of the unit's environment. Hard surfaces such as cabinets, wood, vinyl or tiled floors and paneled walls have a tendency to reflect normal appliance operating noises.

Listed below are common refrigeration components with brief description of the normal operating sounds they make. NOTE: Your product may not contain all the components listed.

- **Compressor:** The compressor makes a hum or pulsing sound that may be heard when it operates.
- **Evaporator:** Refrigerant flowing through an evaporator may sound like boiling liquid.
- **Condenser Fan:** Air moving through a condenser may be heard.
- **Automatic Defrost Drain Pan:** Water may be heard dripping or running into the drain pan when the unit is in the defrost cycle.
- **Running Water:** As your unit continues to produce ice you will hear water flowing into the collection chambers and running over the evaporator.

Troubleshooting Guide

DANGER

ELECTROCUTION HAZARD. Never attempt to repair or perform maintenance on the unit until disconnecting the main electrical power.

Troubleshooting - What to check when problems occur:

Problem	Possible Cause and Remedy
Unit Does not operate. Electronic display blank	No electrical supply. Plug unit in or check circuit breaker.
No Interior light	CLR20175, Tighten or replace bulb, See Maintenance CLR2160, contact Service.
Display showing error code	If display shows error I0E or ER, check to make sure door is sealing correctly. Make sure to close door completely. If sealing the door does not clear the error, contact U-Line service for more information.
Unit Develops Condensation on External surfaces	The unit is exposed to excessive humidity, moisture will dissipate as humidity levels decrease.
Product is Freezing in Combo Models.	Adjust the temperature to a warmer set-point. (See PRODUCT OPERATION)
Product is Not Cold Enough in Combo Models.	Air temperature does not indicate product temperature. See PRODUCT OPERATION - Checking Product Temperature. Adjust the temperate to a cooler set-point. (See PRODUCT OPERATION) Ensure unit is not located in excessive ambient temperatures or in direct sunlight. Ensure the door is closing and sealing properly. Ensure the interior light has not remained on too long. Ensure nothing is blocking the front grille, found at the bottom of the unit. Ensure the condenser coil is clean and free of any dirt or lint build-up.
Poor Ice quality.	Unit may not be level. Check unit for levelness. (See MAINTENANCE) Ice maker system may be dirty. Clean the ice maker. (See MAINTENANCE)
No Ice Production	Ensure water is being supplied to the unit. Verify the ice making unit is turned on (See PRODUCT OPERATION)
Not Enough Ice	Ensure the condenser coil is clean and free of any dirt or lint build-up.
Water in Bucket	Drain may be restricted, ensure drain is free of foreign debris.

PRODUCT INFORMATION

Complete Installation Guides, Use and Care Guides, Specifications & Features and Benefits, CAD Drawings, Overlay Panel/Frame and Toe-Kick Specifications and Instructions, Compliance Documentation and Applicable Energy Guides are available for reference and download at u-line.com.

SERVICE INFORMATION

Please consult your Use and Care Guide for troubleshooting information. Answers to Customer Frequently Asked Questions are available at u-line.com under Customer Service. You may contact U-Line directly:

GENERAL INQUIRIES:

U-Line Corporation
P.O. Box 245040
Milwaukee, Wisconsin 53224-9540 U.S.A.
Phone 1-414-354-0300
FAX 1-414-354-7905
Email: sales@u-line.com
u-line.com

SERVICE ASSISTANCE:

Phone 1-800-779-2547
FAX 1-414-354-5696
Email: onlineservice@u-line.com
u-lineservice.com

PARTS ASSISTANCE:

E-mail: onlineparts@u-line.com

BUILDING ON THREE GENERATIONS OF INNOVATION

For over five decades and through three generations, U-Line continues to be the leader in innovation, quality and performance in the premium built-in undercounter ice making, refrigeration and wine preservation market. U-Line has captivated those with an appreciation for the finer things with exceptional functionality, style, inspired innovation and attention to even the smallest details. We are known and respected for our unwavering dedication to product design, quality and selection.

In 1962, Henry Uihlein founded U-Line Corporation as an outgrowth of Ben-Hur Freezer Company and was the first to develop and patent an automatic stand-alone undercounter residential ice maker. His foresight and determination to develop new ideas and to succeed when there were no clear guidelines or solutions are evident today. The newest Uihlein generation continues to build upon the family's innovative legacy at the Milwaukee, Wisconsin based business by providing continuity and vision from which new designs and technology continue to be born.

Today the complete U-Line product collection includes Ice Makers, Ice Machines, Wine Captain[®] Models, Combo[®] Models, Refrigerator / Freezers, Refrigerators, Drawer Models and Beverage Centers. The U-Line brand offers products in the 1000 Series, 2000 Series and the Modular 3000 Series. The 1000 Series offers a more targeted priced product with appropriate features, while the 2000 Series offers upscale features, advanced technology and specialized product families. Our Modular 3000 Series provides sleek design and versatile temperature settings with our U-Select[®] control. U-Line's approach to its breadth of products, multiple price points and features allows a choice and product that will fit any lifestyle.

DESIGNED, ENGINEERED AND ASSEMBLED IN WISCONSIN, USA

Free Manuals Download Website

<http://myh66.com>

<http://usermanuals.us>

<http://www.somanuals.com>

<http://www.4manuals.cc>

<http://www.manual-lib.com>

<http://www.404manual.com>

<http://www.luxmanual.com>

<http://aubethermostatmanual.com>

Golf course search by state

<http://golfingnear.com>

Email search by domain

<http://emailbydomain.com>

Auto manuals search

<http://auto.somanuals.com>

TV manuals search

<http://tv.somanuals.com>