

## *Échelon Series*

# Use and Care Guide

**Combo® Ice Maker/Refrigerator Model:  
CO2175FF**

**Refrigerator/Freezer Model:  
2175RF**



**CO2175FF**



**2175RF**

**1 Introduction**

Congratulations on your purchase of a U-Line refrigeration product. A pioneer in the field for more than 40 years, U-Line Corporation is the world's number one manufacturer of built-in, under-counter, specialty refrigeration and ice making products. U-Line dedicates 100% of its research and development to these products. The result: U-Line technology consistently leads the market with innovation, design, depth of product line and performance.

U-Line products are making life more convenient in homes, businesses, and hotels around the world. U-Line supports its products with a strong dealer network, and its commitment to quality even extends to environmentally safe packaging.

**IMPORTANT**

**READ all of the instructions in this guide completely before operating the unit for the first time.**

For future reference, keep this guide in a safe, accessible location. If you need additional information or assistance, please contact U-Line Corporation directly. Contact information appears on the rear cover of this guide.

If you have a problem with the operation of this product, the SERVICE section of this guide will assist you in quickly identifying common problems and provide information on possible causes and remedies. If your product needs service, contact U-Line directly.

**Warranty Registration**

Your U-Line Corporation Limited Warranty is located on the inside rear cover of this guide. To validate your warranty, the product and its original purchase date must be registered. A Warranty Registration Card has been included for this purpose in the package containing this manual. Complete and mail the Warranty Registration Card, or register your product online at [www.U-LineService.com](http://www.U-LineService.com) as soon as possible after purchase.

If your product registration is not on file and a request for warranty coverage is received, the date of sale to the U-Line Selling Dealer or Distributor will be established as the first date of warranty coverage for your product.

**Please Record Your Model Information**

When you request additional information or service, you will be asked for your products model and serial numbers. You can find this information on the serial plate located on the upper right or rear wall in the interior of your unit. This information also appears on the warranty registration card.



**Figure 1**

Please record the model number (**Figure 1, 1**), serial number (**Figure 1, 2**), date of purchase, and dealer contact information for your U-Line product below:

**Model Number:**

\_\_\_\_\_

**Dealer Name:**

\_\_\_\_\_

**Serial Number:**

\_\_\_\_\_

**Dealer Address:**

\_\_\_\_\_

**Purchase Date:**

\_\_\_\_\_

**Dealer Telephone:**

\_\_\_\_\_

**2 Table of Contents**

---

Introduction .....2  
    Warranty Registration .....2  
    Please Record Your Model Information .....2  
Table of Contents .....3  
Safety Precautions .....5  
    Safety Alert Definitions .....5  
    General Precautions .....5  
Product Features .....6  
    Échelon Model 2175RF Refrigerator/Freezer, Model CO2175FF Ice Maker/  
    Refrigerator .....6  
Operation .....7  
    Initial Startup .....7  
    Temperature Control .....7  
    Interior Lighting .....8  
    Electronic Control Panel .....8  
    Ice Maker .....9  
    Normal Operating Sounds .....9  
    Food Storage .....10  
    Outdoor, Marine and RV Usage .....10  
    Storage, Vacation, Moving .....10  
    Product Disposal .....11  
Cleaning and Maintenance .....11  
    General Cleaning .....11  
    Maintenance .....12  
Service .....18  
    Before Calling for Service .....18  
    If Service is Required .....18  
    Replacement Parts .....18  
    Troubleshooting Guide .....19  
    Electronic Control Quick Guide .....21  
U-Line Corporation Limited Warranty .....23

**This page intentionally left blank**

### 3 Safety Precautions

#### IMPORTANT

PLEASE READ all instructions completely before attempting to install, operate, or service your unit.

- Proper installation procedures must be followed if this unit is being initially installed, or is moved to a new location after being in service. An **INSTALLATION GUIDE** for your unit, providing complete installation information is available from U-Line Corporation directly, and must be consulted before any installation is begun. U-Line contact information appears on the rear cover of this guide.
- This unit requires connection to a grounded (three-prong), polarized receptacle that has been placed by a qualified electrician in accordance with applicable electrical codes.

### Safety Alert Definitions

Safety items throughout this guide are labeled with a Danger, Warning or Caution based on the risk type:

#### DANGER

**Danger means that failure to follow this safety statement will result in severe personal injury or death.**

#### WARNING

**Warning means that failure to follow this safety statement could result in serious personal injury or death.**

#### CAUTION

**Caution means that failure to follow this safety statement may result in minor or moderate personal injury, property or equipment damage.**

### General Precautions

Use this appliance for its intended purpose only and follow these general precautions along with those listed throughout this guide:

#### DANGER

**RISK OF CHILD ENTRAPMENT.** Before you throw away your old refrigerator or freezer, take off the doors and leave shelves in place so that children may not easily climb inside.

#### WARNING

**SHOCK HAZARD - Electrical Grounding Required.**

- Never attempt to repair or perform maintenance on the unit until the electricity has been disconnected.
- Never remove the round grounding prong from the plug and never use a two-prong grounding adapter.
- Altering, cutting of power cord, removal of power cord, removal of power plug, or direct wiring can cause serious injury, fire and/or loss of property and/or life, and will void the warranty.
- Never use an extension cord to connect power to the unit.
- Always keep your working area dry.

#### CAUTION

- Use care when moving and handling the unit. Use gloves to prevent personal injury from sharp edges.
- If your model requires defrosting, **DO NOT** use any type of heater to defrost. Using a heater to speed up defrosting can cause personal injury and damage to the inner lining.

#### IMPORTANT

- Do not lift unit by door handle.
- Never install or operate the unit behind closed doors. Be sure front grille is free of obstruction. Obstructing free air flow can cause the unit to malfunction and may void the warranty.
- Failure to clean the condenser every three months can cause the unit to malfunction. This could void the warranty.
- Allow unit temperature to stabilize for 24 hours before use.
- If your model requires defrosting, never use an ice pick or other sharp instrument to help speed up defrosting. These instruments can puncture the inner lining or damage the cooling unit.
- Use only genuine U-Line replacement parts. Imitation parts can damage the unit, affect its operation or performance and may void the warranty.

## 4 Product Features

### Échelon Model 2175RF Refrigerator/ Freezer, Model CO2175FF Ice Maker/ Refrigerator

#### Exclusive Features of Échelon

- Both models feature Frost Free technology and a 5.7 cu ft (161 L) capacity.
- An electronic control panel with digital display allows you to display the interior temperature and adjust the setting to your preference. The electronic control and digital display provide an attractive appearance, and its method of control provides precise temperature settings.
- An interior light will illuminate automatically as the cabinet door is opened. However, you can easily select another mode of operation. A blackout/Sabbath mode (not Star K certified) allows you to darken both interior light and the LED display, while maintaining complete temperature control in the unit for 36 hours.
- A new condenser design optimizes product performance and energy efficiency while providing further reductions in noise levels.
- A new evaporator and improved refrigeration system design provide freezer temperatures between -5 and +5°F, and consistent temperature control in the refrigerator.
- Model 2175RF features a large vertically designed freezer compartment that provides more storage space and easier accessibility to the products within the freezer compartment. A removable white vinyl coated wire shelf can divide the compartment in half, allowing products to be placed underneath and on top of the shelf for more organized storage.
- Model CO2175FF features an ice maker with a daily production capacity of 8 lbs (3.6 kg), and storage for 13 lbs (5.9 kg).
- Three fully encapsulated, contoured shelves contain spills and are easy to clean.
- Recessed shelf channels, supporting the encapsulated shelves, provides a sleek, clean appearance to the interior of the cabinet by eliminating protruding shelf supports.
- A removable, clear lower crisper drawer optimizes the organization of product stored in the crisper. The crisper may also be used to transport its contents to a cooking or serving area.
- Two contoured inner door "pick-off" shelves are adjustable for storage of a variety of different bottle, can, and container sizes and shapes.
- The lower inner door shelf accommodates a two liter or 750 mL bottle.
- Self-closing door hinges engage when the door is open approximately 8-10 in. (20-25 cm), ensuring a positive door seal and preventing door bounce back.
- Black and white models feature a slightly contoured, across the top, integrated door handle design that permits the door to be easily reversed. The doors come standard with a factory installed flush panel. They can accommodate a 1/4 in. (0.64 cm) thick custom panel to achieve a custom, built-in look by matching surrounding cabinets.
- An optional full overlay door panel kit for black and white units, using a customer provided 3/4 in. (1.9 cm) thick panel, is available that provides a fully integrated appearance with surrounding cabinets. The overlay panel is easily attached to the door.
- Black and white models feature a vinyl clad steel cabinet that provides a rich textured look, and resists scratching, peeling and flaking.
- All stainless steel models have a full wrap stainless steel cabinet, stainless steel hinges, and a full wrap stainless steel door with sculpted stainless steel handle.
- Stainless steel models are suitable for outdoor use by UL.

Features and specifications are subject to change without notice.

**5 Operation**

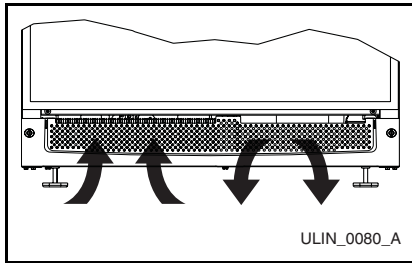

**Figure 2**

**IMPORTANT**

Proper air flow (Figure 2) is required for your unit to operate at its highest efficiency. A grille, located in the base of the unit, must not be blocked at any time, or your unit will not perform as expected.

**Initial Startup**

All U-Line units are shipped with controls that are preset. No initial adjustments are required.

**IMPORTANT**

- U-Line recommends the unit be allowed to run overnight prior to loading the unit with product.
- On ice maker equipped units, it is possible that dirt or scale will dislodge in the water line. Always throw away all ice cubes made during the first two to three hours of operation.

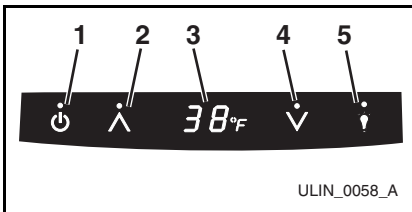

**Figure 3**

To turn the unit on or off, touch and hold the POWER icon (Figure 3, 1) on the display panel for approximately ten seconds until the °F symbol flashes and release.

- A small LED above the icon will illuminate to confirm the touch of any controller icon.
- The display (Figure 3, 3) will show the unit set-point temperature (38°F) when the unit is on and will show OFF when the unit is off.
- Turning the unit off will override any other control function.

**Temperature Control**

**Checking Product Temperature**

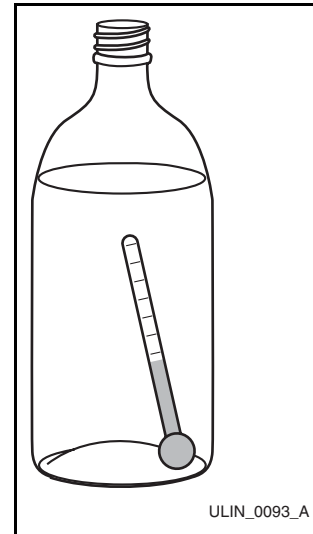

**Figure 4**

To check the actual product temperature, in refrigerator section only, insert an accurate thermometer into a plastic (non-breakable) bottle that is partially filled with water. Tighten the bottle cap securely (Figure 4).

Place the bottle in the refrigerator area for 24 hours. Refrain from opening the unit during the testing period. After 24 hours, check the temperature of the water. If required, adjust the temperature control in a small increment (See ADJUSTING TEMPERATURE).

Factors which affect the internal temperatures of the cabinet include:

- Temperature setting.
- Ambient temperature where installed.
- Number of times and length of time the door is opened and closed.
- Installation in direct sunlight or near a heat source.

## Interior Lighting

The LIGHT icon (**Figure 3, 5**) on the control panel is used to control an additional lighting function. The blackout/Sabbath mode (not Star K certified) will turn the interior light and display (**Figure 3, 3**) off.

To access the blackout/Sabbath mode (not Star K certified):

1. Touch and hold the LIGHT icon (**Figure 3, 5**) for ten seconds and release (the °F symbol will flash briefly at the end of the five second period).
2. The interior light and control display (**Figure 3, 3**) will go dark for 36 hours.

**NOTE:** Although the display will not be visible, the temperature controls in the unit remain active, and the interior temperature will be maintained.

3. To exit the blackout/Sabbath mode (not Star K certified) before the 36-hour time period, repeat Step 1.

## Electronic Control Panel

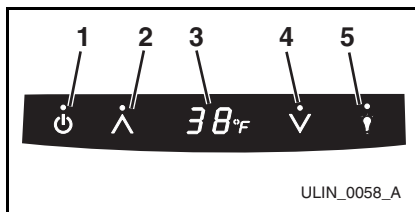

**Figure 5**

The electronic control with digital display (**Figure 5**) is configured to show a single temperature continuously. This set-point temperature is a base number used by the controller to maintain the temperature zone in your unit. The factory default set-point is 38°F. This set-point temperature is used as a gauge if further temperature adjustments are required.

## Temperature Display Selection

U-Line products supplied for 110 VAC operation have temperatures displayed in a default Fahrenheit (°F) configuration (**Figure 5, 3**). Models supplied for 220 VAC operation have temperatures displayed in a default Celsius (°C) configuration.

The display can easily be adjusted for either type of temperature display. Press and hold the LIGHT icon (**Figure 5, 5**) and within five seconds press the COOLER icon (**Figure 5, 4**) three times to change the display as desired.

## Temperature Display

To display the interior temperature:

1. Touch and hold the WARMER icon (**Figure 5, 2**) for approximately five seconds and release when the °F symbol in the display (**Figure 5, 3**) begins to flash.
2. The display (**Figure 5, 3**) will indicate the actual refrigerator temperature.
3. After approximately 10 seconds, the set-point temperature will return to the display.

Factors which affect the internal temperatures of the cabinet include:

- Temperature setting.
- Ambient temperature where installed.
- Number of times and length of time the door is opened and closed.
- Installation in direct sunlight or near a heat source.

## Adjusting Temperature

**NOTE:** Refrigerator section temperatures are adjustable. Freezer temperatures are not adjustable.

### IMPORTANT

**Adjust the set-point temperature in single increments, and wait 24 hours for the temperature to stabilize before rechecking.**

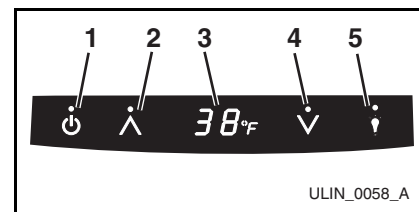

**Figure 6**

To adjust the set-point temperature:

1. Press and release either the WARMER (**Figure 6, 2**) or COOLER (**Figure 6, 4**) icon to put the controller in the SET TEMPERATURE mode. The °F symbol (**Figure 6, 3**) will begin to flash.

**NOTE:** If no further action is taken, this mode will self cancel in five seconds, and the original set-point temperature will be displayed.

2. While the °F symbol is flashing, press the WARMER or COOLER icon as required to adjust the set-point temperature.
3. The change will be set five seconds after adjusting the temperature and the new set-point temperature will be displayed.



## Ice Maker

When the ice bucket is full, the ice making mechanism will shut off. However, the refrigeration system will continue to cool and maintain the cube supply. Frost-free icemaker units have lower ice production than manual defrost units.

### IMPORTANT

**Do not place cans or bottles in the ice compartment because they will freeze.**

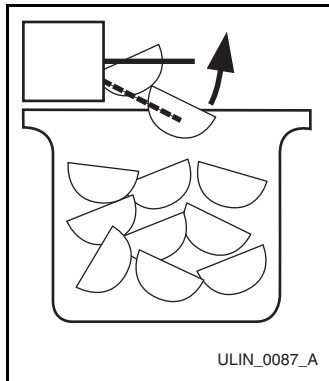

**Figure 7**

Ice production may be interrupted by raising the bin arm into an upright and locked position (**Figure 7**). The unit will maintain temperature for ice storage.

### IMPORTANT

**If you are not intending to use the ice maker and turn the supply valve off, it is imperative to raise the bin arm of the ice maker (Figure 7). Failure to raise the bin arm may result in damage to the water valve.**

Certain sounds are normal during the unit's operation. You may hear the compressor or fan motor, the water valve, or ice dropping into the ice bucket.

### WARNING

**NEVER use an ice pick, knife or other sharp instrument to separate cubes. Shake the ice bucket instead.**

During periods of limited usage or high ambient temperatures, it is common for cubes to fuse together. Shake the bucket to break apart cubes. If the ice maker is not used regularly, the ice bucket should be emptied periodically to ensure fresh cubes.

It is normal for cubes to appear cloudy. This is caused by air being trapped in the water due to fast freezing. It has nothing to do with the health, taste or chemical make-up of the water. It is the same air that is in every glass of water you drink.

The ice bucket can be removed for emptying and cleaning. To remove the ice bucket, raise the bin arm and remove the bucket from the ice compartment. Use the ice bucket for ice storage only.

## Normal Operating Sounds

All models incorporate rigid foam insulated cabinets to provide high thermal efficiency and maximum sound reduction for its internal working components. In spite of this technology, your model may make sounds that are unfamiliar.

Normal operating sounds may be more noticeable because of the unit's environment. Hard surfaces such as cabinets, wood/vinyl/tiled floors and paneled walls have a tendency to reflect normal appliance operating noises.

Common refrigeration components, and a brief description of the normal operating sounds they make, are listed below. **NOTE:** Your product may not contain all of the components listed.

- **Compressor:** The compressor makes a hum or pulsing sound that may be heard when it operates.
- **Evaporator:** Refrigerant flowing through an evaporator may sound like boiling liquid.
- **Condenser Fan:** Air moving through a condenser may be heard.
- **Automatic Defrost/Drain Pan:** Water may be heard dripping or running into the drain pan when the unit is in the defrost cycle.
- **Automatic Ice Maker:** You will hear ice as it drops from the mold into the ice bin/tray.
- **Water Valve:** After an ice maker completes a cycle, a water valve will make a buzzing sound and running water may be briefly heard.

## Food Storage

### Crisper

Your models may have a lower crisper drawer for storage.

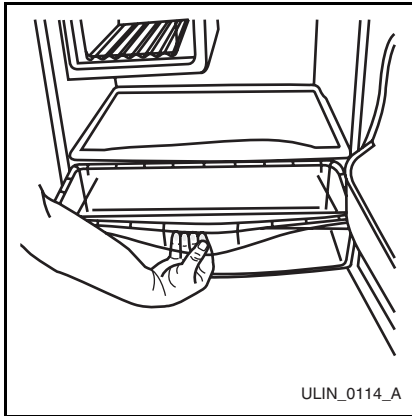

**Figure 8**

To open, grasp the crisper handle (**Figure 8**) and slowly pull out to access the drawer contents. The crisper may be completely removed for cleaning.

#### IMPORTANT

**If the drawer is pulled out too far, it will come out of the cabinet, and may be damaged by falling.**

## Outdoor, Marine and RV Usage

Some U-Line models are designed to operate in outdoor, marine and RV environments. For best performance, keep the unit out of direct sunlight.

- If the unit will be shut off for five days or more, prop door open to allow for air circulation and prevent mold and mildew.

#### IMPORTANT

**If the ambient temperature is expected to drop below 45°F, turn off and unplug unit, and drain all water from the unit to prevent freezing damage not covered by the warranty.**

- High ambient temperatures (110°F or higher) may reduce the unit's ability to reach low temperatures.

## Storage, Vacation, Moving

If the unit will not be used for an extended period, or otherwise stored, follow these steps completely:

#### **⚠ WARNING**

**Electrical Shock Hazard. Disconnect power before servicing. Before operating, replace all panels. Failure to do so may result in death or electrical shock.**

1. Remove all consumable contents from the unit.
2. Disconnect power to the unit.
3. Shut off water supply to the unit at the main water source.

#### IMPORTANT

- **If the ambient temperature is expected to drop below 45°F, turn off and unplug unit, and drain all water from the unit to prevent freezing damage not covered by the warranty.**
  - **The use of anti-freeze or other products of this nature is not necessary and is not recommended.**
4. Disconnect the water valve inlet and outlet lines, and allow them to drain completely.
  5. Reconnect power to the unit, and allow it to run for one hour (minimum) until any remaining ice has been ejected from the ice maker assembly.
  6. Disconnect power to the unit, dry any remaining water from the ice maker assembly, and reconnect any lines removed from the water supply valve.
  7. Disconnect the power cord from its outlet, and leave it disconnected until the unit is returned to service.
  8. Clean and dry the interior of the cabinet (See CLEANING AND MAINTENANCE: GENERAL CLEANING).
  9. During periods of non-use, the cabinet must remain open to prevent the formation of mold and mildew. Open door a minimum of 2" (5 cm) to provide the necessary ventilation.

## Product Disposal

If the unit is being removed from service for disposal, check and obey all Federal, State and/or Local regulations regarding the disposal and recycling of refrigeration appliances, and follow these steps completely:

1. Disconnect power to the unit and unplug the power cord from its outlet.
2. Shut off water supply to the unit at the main water source and disconnect the supply line to the unit's water valve.

### **DANGER**

**RISK OF CHILD ENTRAPMENT. Before you throw away your old refrigerator or freezer, take off the doors and leave shelves in place so that children may not easily climb inside.**

3. Remove the cabinet door if equipped and secure all interior shelves to the interior of the cabinet using a heavy duty cloth or package sealing tape.

## 6 Cleaning and Maintenance

### General Cleaning

#### Exterior Cleaning (As Required)

##### Black and White Models:

- Surfaces may be cleaned with a mild detergent and warm water solution. Do not use solvent-based or abrasive cleaners. Use a soft sponge and rinse with clean water. Wipe with a soft, clean towel to prevent water spotting.

##### Stainless Steel Models:

- Stainless steel surfaces and components can discolor when exposed to chlorine gas, pool chemicals, salt water or cleaners with bleach.
- Keep your stainless steel unit looking new by cleaning with a good quality all-in-one stainless steel cleaner/polish on a monthly basis. For best results use Claire® Stainless Steel Polish and Cleaner, which can be purchased from U-Line Corporation (P/N 173348). Comparable products are acceptable. Frequent cleaning will remove surface contamination that could lead to rust. Some installations may require cleaning on a weekly basis.
- **Do not clean with steel wool pads.**
- **Do not use cleaners that are not specifically intended for stainless steel on stainless steel surfaces (this includes glass, tile and counter cleaners).**
- If any surface discoloring or rusting appears, clean it quickly with Bon-Ami® or Barkeepers Friend Cleanser® and a non-abrasive cloth. Always clean in the direction of the grain. Always finish this process with Claire Stainless Steel Polish and Cleaner or comparable product to prevent further problems.
- **Using abrasive pads such as Scotchbrite™ will cause the graining in the stainless steel to become blurred.**
- Rust that is not cleaned up promptly can penetrate into the surface of the stainless steel and complete removal of the rust may not be possible.

#### Interior Cleaning (As Required)

- Disconnect power to the unit. Clean the interior and all removed components using a mild non-abrasive detergent and warm water solution applied with a soft sponge or non-abrasive cloth. Rinse the interior using a soft sponge and clean water.
- **Do not use any solvent-based or abrasive cleaners. These types of cleaners may transmit taste to the interior products and damage or discolor the interior.**

## Maintenance

Proper maintenance of your U-Line product will ensure efficiency, top performance and long life. The maintenance intervals listed are based on normal conditions. You may want to shorten the intervals if you have pets or other special considerations.

### Defrosting

#### Frost-Free Models

Frost-free models do not produce frost in normal operating conditions.

#### WARNING

**DO NOT use any type of electrical heating device, ice pick, knife or other sharp instrument to defrost; this could damage the inner lining or refrigeration system and void the warranty.**

### Condenser Cleaning

#### Interval - Every Three Months

To maintain operational efficiency, keep the front grille free of dust and lint and clean the condenser every three months. Depending on environmental conditions, more or less frequent cleaning may be necessary.

#### WARNING

**Disconnect electric power to the unit before cleaning the condenser.**

To remove and replace the grille for access to the condenser fins, follow this procedure:

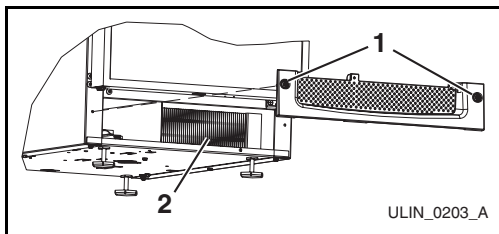

**Figure 9**

1. Disconnect electrical power to the unit.
2. Loosen two screws (**Figure 9, 1**) completely.

**NOTE:** Screws are held in the grille by o-ring retainers, and will not come free of the grille.

3. Remove the grille.

#### WARNING

**DO NOT touch the condenser fins. The condenser fins are SHARP and can be easily damaged.**

#### CAUTION

**DO NOT use any type of cleaner on the condenser unit.**

4. Clean the condenser coil (**Figure 9, 2**) using a soft brush with a "combing" action or vacuum cleaner. Do not touch the condenser coil.
5. Position the grille to align the mounting screws with the holes in the cabinet.
6. Secure, but do not over-tighten both grille screws.
7. Reconnect power to the unit.

### Ice Maker Maintenance

#### Inlet Screen

#### Interval - Every Twelve Months

The solenoid valve inlet screen must be cleaned at least once each year as follows:

1. Shut off the water at the main supply valve.
2. Pull the unit out to access the back panel.
3. Disconnect electrical power to the unit.

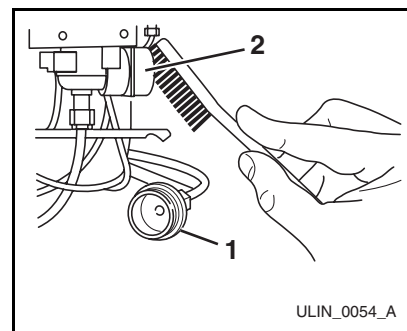

**Figure 10**

4. Disconnect the hose connector (**Figure 10, 1**) from the water solenoid valve (**Figure 10, 2**).
5. **DO NOT** remove the inlet screen from the water solenoid valve. Use a tooth brush to gently clean any sediment from the inlet screen.
6. Re-connect the water supply hose connector (**Figure 10, 1**) to the water solenoid valve (**Figure 10, 2**). Tighten the connector securely.
7. Open the water main supply valve and check for leakage at the water hose connection. Ensure that the water supply line is not kinked.
8. Reconnect power to the unit before re-installing.

**Ice Cube Thickness Adjustment**

**Interval - As Required**

On ice maker equipped models, the cube size may be adjusted by changing the amount of water injected into the ice maker assembly as follows:

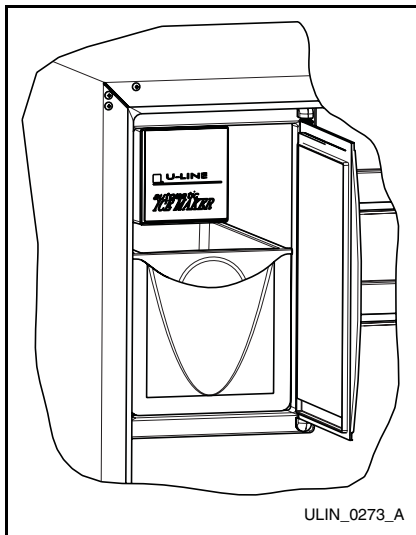

**Figure 11**

1. Remove the ice maker assembly cover (**Figure 11**).

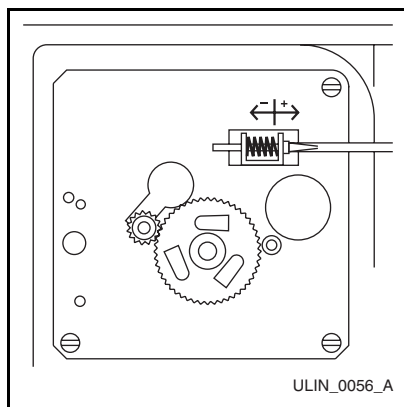

**Figure 12**

2. Locate the adjusting screw on the ice maker assembly control box. The adjusting screw is just below the minus (-) and plus (+) signs on the control box (**Figure 12**).

**NOTE:** Make adjustments in small increments. Too large of an adjustment could cause the unit to malfunction.

**⚠ CAUTION**

**Too large of an adjustment to the screw can cause the water to overflow the ice maker and can cause property damage.**

3. Turn the adjusting screw toward the minus (-) sign (clockwise) for smaller cubes or toward the plus (+) sign (counterclockwise) for larger cubes.

4. Install the ice maker assembly cover.

**IMPORTANT**

**Use only genuine U-Line replacement parts. U-Line ice maker parts are not the same as standard FSP Whirlpool parts. Using non U-Line parts can reduce ice rate, cause water to overflow from ice maker mold, damage the unit, and may void the warranty.**

**Leveling**

It is important that units equipped with adjustable feet are level, for proper door and ice maker (if equipped) operation.

To level units with adjustable feet:

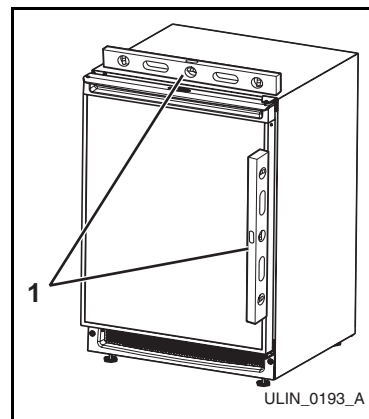

**Figure 13**

1. Use a level to check the levelness of the unit from front to back and from side to side. Level should be placed along top edge and side edge as shown (**Figure 13**).

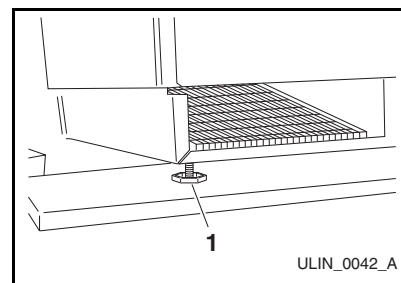

**Figure 14**

2. If the unit is not level, adjust the feet on the corners of the unit as necessary (**Figure 14**).
3. Check the levelness after each adjustment and repeat the previous steps until the unit is level.

## Door Alignment Check and Adjustment

### IMPORTANT

When properly aligned:

- The door will not be flush with the top of the cabinet. The top edge of the door will be 1/8 in. (3.175 mm) below the cabinet top.
- The door gasket will be firmly in contact with the perimeter of the cabinet and not pinched on the hinge side of the door.

The following procedure will correct for up to 1/4 in. misalignment:

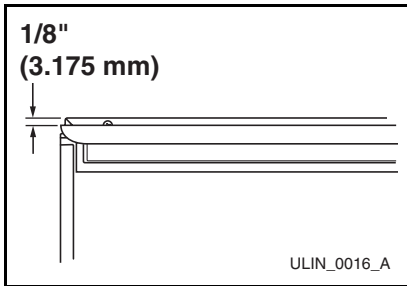

**Figure 15**

1. Compare the top edge of the door (opposite the hinges) to the top edge of the cabinet (**Figure 15**) and note the type (up or down) of adjustment needed.

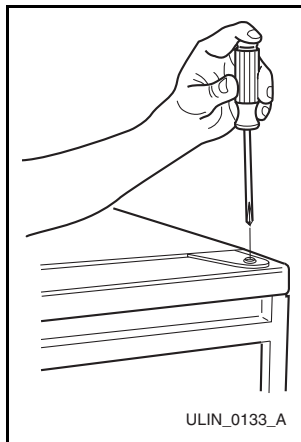

**Figure 16**

2. Remove the top hinge pivot pin with a Phillips screwdriver (**Figure 16**) and lift door off bottom hinge pin. Be careful not to lose the door closer insert sets.

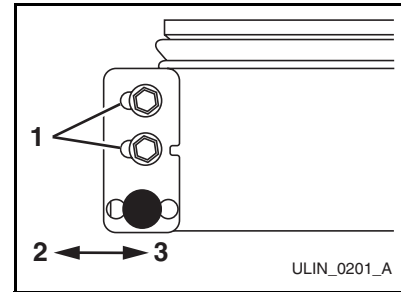

**Figure 17**

3. Turn the door upside down and inspect the hinge plate mounting holes.
  - Your plate has slotted mounting holes (**Figure 17, 1**). Loosen but do not remove the two hinge plate screws.
4. If door edge opposite the hinges needs to move up, move plate toward outside of door (**Figure 17, 2**). If door edge needs to move down, move plate toward inside of door (**Figure 17, 3**). Repeat until top edge of door is parallel with top of cabinet and tighten screws securely (**Figure 17, 1**).

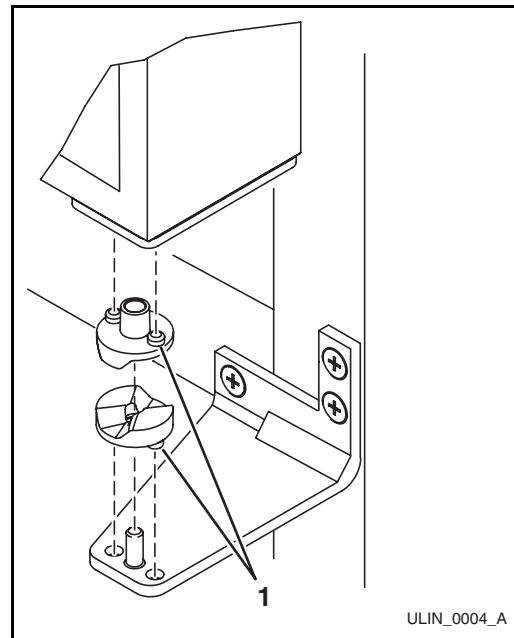

**Figure 18**

5. After adjustment is complete, remove the door closers from the bottom hinge, clean thoroughly and apply petroleum jelly to the mating surfaces of the closers. Be sure that bosses on closers (**Figure 18, 1**) align with holes in the door and bottom cabinet hinge plates. Mount door and install top hinge pivot pin.

**Door Reversal**

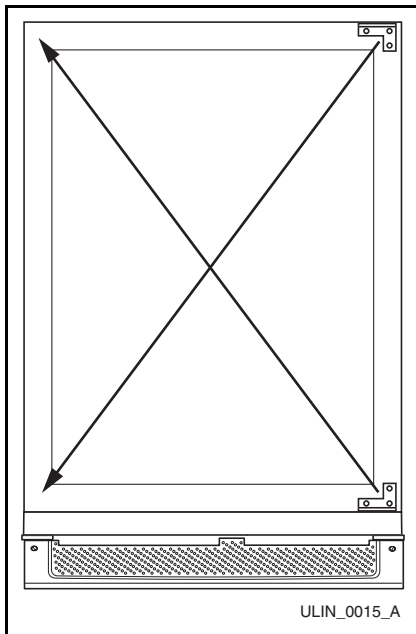

**Figure 19**

Black and white units may be left- or right-hand opening. Stainless steel unit doors cannot be reversed. The doors are easily reversed by moving the hinge hardware to the opposite side. The top hinge hardware will be used on the bottom of the other side and the bottom hinge hardware will be used on the top of the other side (**Figure 19**).

To reverse the door:

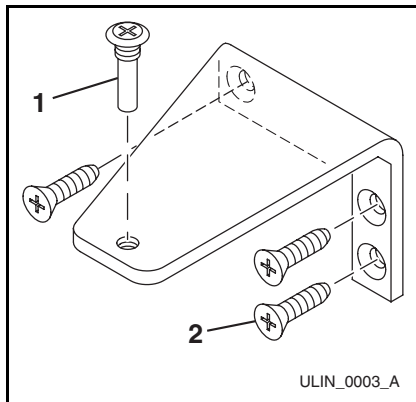

**Figure 20**

1. Remove top hinge screw pin (**Figure 20, 1**) from door using a Phillips screwdriver. Remove door by tilting forward and lifting off bottom hinge pin.

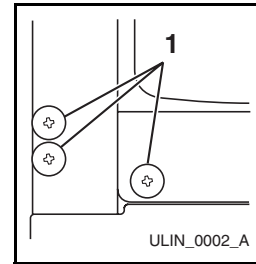

**Figure 21**

2. Remove plastic screw plugs (three each, top and bottom) (**Figure 21, 1**) from new hinge location. Do not discard.
3. Remove top hinge (three screws) (**Figure 20, 2**) and reinstall hinge screw pin (**Figure 20, 1**).

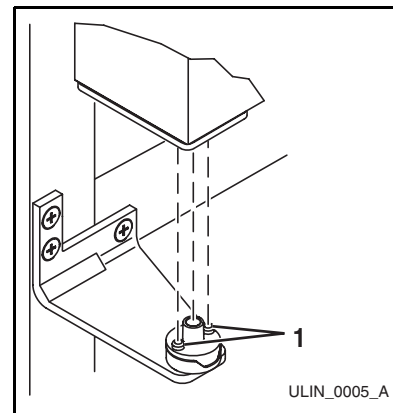

**Figure 22**

4. Install the removed top hinge mount on opposite side **BOTTOM** (**Figure 22**).

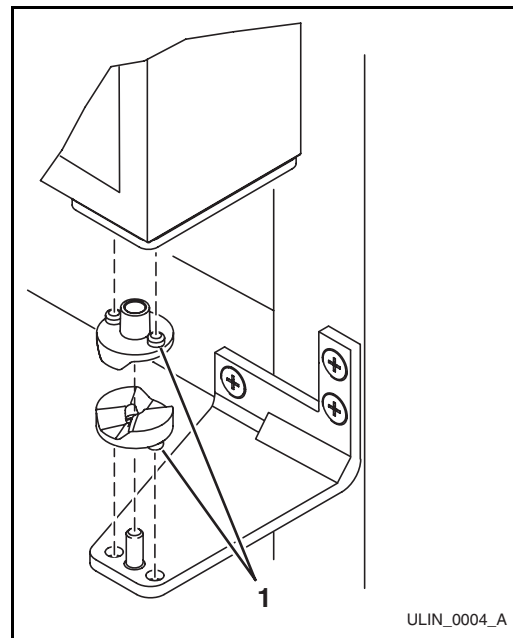

**Figure 23**

5. Remove the two door closer inserts (**Figure 23, 1**) from the existing bottom hinge and install as shown on the new bottom hinge (**Figure 22, 1**).
6. Remove existing bottom hinge (three screws) and remount on opposite side TOP. Remove hinge screw pin.
7. Remove the plastic hole plug from the top of the door to allow the pivot pin to be inserted in the new location. Install the plug into the vacated hole on the opposite side.

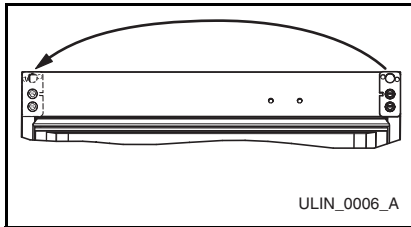

**Figure 24**

8. With bottom of door facing up, remove pivot plate (two screws), flip over, and remount on opposite side of door (**Figure 24**). **Be sure notch in plate faces center.**
9. Holding door upright with top of door tilted forward, place hole of door pivot plate on bottom hinge screw pin/closer inserts (**Figure 22, 1**).
10. Tilt top of door into position in top hinge and install top hinge screw pin.
11. Install plastic screw plugs removed in Step 2 in old hinge holes (three each, top and bottom).

### Door Shelf Removal/Insertion

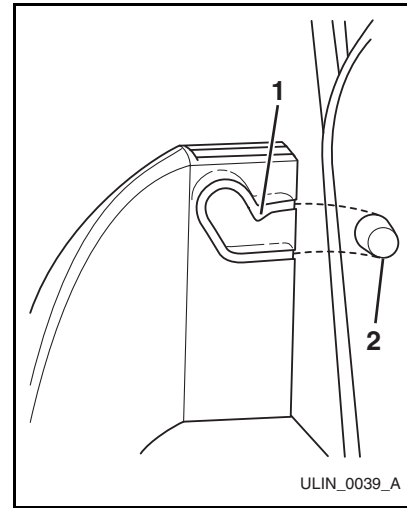

**Figure 25**

To remove the door shelf:

1. Grasp shelf in center, lift slightly, and tilt 15°-20°.
2. Carefully pull shelf off bosses (**Figure 25, 2**).

To install the door shelf:

1. Holding shelf in center, align notches (**Figure 25, 1**) in shelf with bosses (**Figure 25, 2**) in door.
2. Tilt shelf at a 15°-20° angle and slide onto bosses at the desired location.



## Glass Shelf Removal/Installation

Remove the shelves as follows:

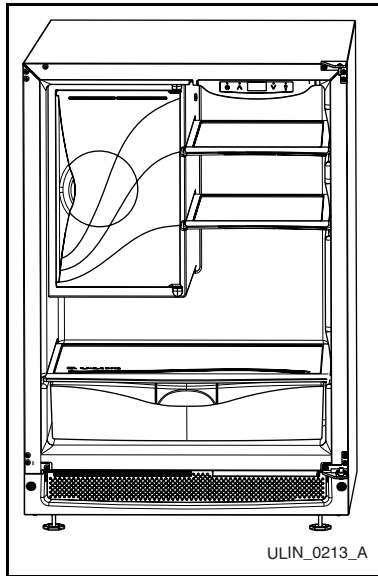

**Figure 26**

1. Pull shelf out about 6" (**Figure 26**) until back of shelf clears the "hump" on the right hand side.
2. Tilt right hand edge of shelf up.
3. Remove shelf from unit by pulling out.

Insert the shelves as follows:

1. Insert shelf at an angle, approximately 15-20°, over the rib in the side of the unit where you want to place the shelf. The shelf must be started into the unit at an angle to clear the door.
2. Continue to slide the shelf into the unit at an angle until it clears the door.
3. Lower the shelf and push it in completely.

## Light Bulb Replacement

To replace the light bulb in your U-Line unit:

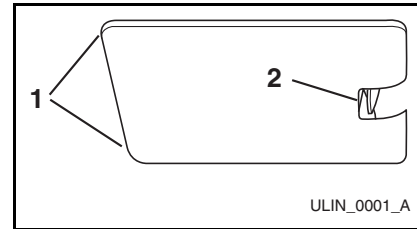

**Figure 27**

1. Grasp the edges of the light housing lens (**Figure 27, 1**) opposite the exposed tab and gently push the lens toward the tab (**Figure 27, 2**).
2. Pull the edge of the lens down (**Figure 27, 1**) and swing it out of the light housing.

### IMPORTANT

**ALWAYS use a genuine U-Line replacement bulb (P/N 31317) in the light housing. Use of any other bulb within the housing will generate excessive heat, causing damage to the light housing and cabinet interior, and will compromise the precise temperature control of your unit.**

3. Replace the bulb only with a genuine U-Line P/N 31317 replacement.
4. Replace the lens by first inserting the tab side back into the housing at a slight angle. While gently pushing the lens towards the tab end, push the free end up into the housing, and release when you will hear a snap/click.

## **7 Service**

---

### **Before Calling for Service**

If your U-Line product appears to be malfunctioning, read through the OPERATION section of this guide to ensure that the function of all controls are clearly understood. If the malfunction persists, the TROUBLESHOOTING GUIDE in this guide will assist you in quickly identifying common problems, and provide information on possible causes and remedies. Most often, this will resolve the problem without the need to call for service.

### **If Service is Required**

If you do not understand a troubleshooting remedy, or your product needs service, contact U-Line Corporation directly. Contact information appears on the rear cover of this guide.

You will be asked for your product Model and Serial Numbers. This information should be recorded inside the front cover of this guide, following the products original purchase. It also appears on the Model and Serial number plate located on the upper right or rear wall of the interior of your product.

### **Replacement Parts**

When you need replacement parts, always request that genuine U-Line replacements be used. U-Line products have been designed and engineered using components that work efficiently, and provide superior service life and performance. The use of aftermarket parts or components may affect the safety, operation, performance or durability of your product, and may also void its warranty.

## Troubleshooting Guide



### **ELECTROCUTION HAZARD**

**Never attempt to repair or perform maintenance on the unit until the main electrical power has been disconnected.**















#### **Troubleshooting - What to check when problems occur:**

<b>PROBLEM</b>	<b>POSSIBLE CAUSE</b>	<b>REMEDY</b>
Unit does not operate and electronic display is blank.	No electrical supply	Plug unit in or check circuit breaker.
No interior light	Loose or burned out bulb	Tighten or replace bulb (See MAINTENANCE; LIGHT BULB REPLACEMENT).
Electronic display is blank and interior light is OFF with door OPEN.	Unit is in blackout/Sabbath mode (not Star K certified) lighting mode.	Exit blackout/Sabbath mode (not Star K certified) (See OPERATION; INTERIOR LIGHT CONTROL).
Electronic display is blank and interior light is ON with door OPEN.	A display function has changed.	Touch and hold the warmer temperature button and touch and release the POWER button three times, then release the temperature button. The display should become visible.
Electronic display shows repeating, randomly flashing symbols and partial characters.	A factory control mode has been inadvertently entered.	Touch and hold the warmer temperature button and touch and release the LIGHT button three times, then release the temperature button to exit the factory control mode. The set-point temperature should now be displayed.
Electronic display shows: 0, 1 to 26, or 99.	A factory control mode has been inadvertently entered.	Repeatedly touch the warmer temperature button to advance any number shown to 99 and touch and release the LIGHT button. The set-point temperature should now be displayed.
Electronic display shows E3.	Door has been left open longer than 20 minutes.	Close door completely. The set-point temperature should now be displayed.
Electronic display shows one or more of the following: E1, E2, E4, E5, E6, E7, E8, E9, E10, P1.	The unit is displaying an error code.	Record the error code(s) displayed and call for service.
Unit not cold enough. Check temperatures (See OPERATION for approximate temperatures).	Control set too warm	Set control to a cooler setting (See OPERATION). Allow 24 hours for temperature to stabilize.
	Airflow to front grille blocked	Airflow must not be obstructed to front grille (See OPERATION).
	Dirty condenser coils	Clean condenser (See MAINTENANCE; CONDENSER CLEANING).
	Door gasket not sealing properly	Door adjustment required (See MAINTENANCE; DOOR ALIGNMENT CHECK AND ADJUSTMENT).
Unit is too cold. Check temperatures (See OPERATION for approximate temperatures)	Control set too cold	Set control to a warmer setting (See OPERATION). Allow 24 hours for temperature to stabilize.
Noise during operation	Copper water supply tubing contacting internal components	Carefully bend tubing away from cabinet and components.
	Certain sounds are normal.	Soft sounds from the fan and water/dropping sounds from the ice maker will be heard.
Refrigerator too cold	Temperature control set too cold	Set control to warmer setting (See OPERATION).
	Inaccurate temperature reading	Properly check temperature (See OPERATION).

<b>PROBLEM</b>	<b>POSSIBLE CAUSE</b>	<b>REMEDY</b>
<b>ICE MAKER EQUIPPED MODELS ONLY</b>		
Water is leaking out the back of the unit.	Water supply connection leaking	Tighten fitting as required.
Ice cubes sticking together	Infrequent use of cubes	Break apart cubes.
No ice	Bin arm locked in upright position	Lower bin arm.
	No water to unit	Turn on water or contact plumber.
Not enough ice	Ice cube size too large	Set cube size smaller (See MAINTENANCE; ICE MAKER; ICE CUBE THICKNESS ADJUSTMENT).
	Dirty condenser coils	Clean condenser (See MAINTENANCE; CONDENSER CLEANING).
Water leaks into ice bucket.	Water level set too high	Set cube size smaller (See MAINTENANCE; ICE MAKER; ICE CUBE THICKNESS ADJUSTMENT).
Refrigerator too cold	Ice bucket not fully inserted	Push ice bucket into place.
	Freezer door not closed correctly	Be sure freezer door is closed correctly.







## Electronic Control Quick Guide

### All Models





Task	Touch	Touch	Display	Comment
Turn ON/OFF	 Hold 10 seconds	Release when °F flashes.		
Adjust Temperature	 or  Touch and release	 or  Touch to change temperature		°F flashes after first touch, set-point saved after 5 seconds of inactivity and °F stops flashing.*
View Actual Temperature	 Hold 5 seconds	Release when °F flashes.		For Wine Coolers, see Use and Care Manual.
Change °F-°C	 Hold	  		Repeat to switch back.
Blackout Mode	 Hold 10 seconds		Display (and cabinet light) not operable in Blackout Mode.	Hold light for 10 seconds to exit.

\* Drawer Wine Cooler: Initially, top bar will flash to set to zone. After five seconds of inactivity (or touching light button), the bottom zone (bottom bar on F flashing) can be adjusted. After five seconds of inactivity, set-point will be stored in unit.







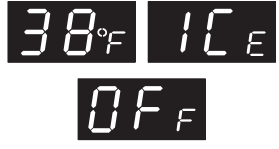







### Glass Door Models

Task	Touch	Touch	Display	Comment
Cabinet Light				Light normally goes on/off with door opening. Pressing light button will turn interior light on for 4 hours, then it will turn off.
Display Off Mode	 Hold	  		Display off when door is closed (unless cabinet light is switched on). Repeat to switch back.

### All Ice Makers

Task	Touch	Touch	Display	Comment
Ice Maker Off Mode	 Hold	  		Repeat to switch back

### Clear Ice & Clear Combo Only

Task	Touch	Touch	Display	Comment
Clean Cycle	 Hold	  		Will automatically return to ice production when clean cycle is complete.
Ice Thickness Adjustment	 Hold	  		Use warmer/colder to scroll.
Temporary Shutdown (Office Mode)	 Hold	  		Ice maker will automatically turn back on in three hours.

**NOTE:** 38°F is an example; the display will vary with actual set-point.

### IMPORTANT

**Factory recommended set-point is 38°F for refrigerators and beverage centers, and 50°F for wine coolers.**

**This page intentionally left blank**

## U-Line Corporation Limited Warranty

U-Line Corporation warrants each U-Line product to be free from defects in materials and workmanship for a period of one year from the date of purchase; and warrants the sealed system (consisting of the compressor, the condenser, the evaporator, the hot gas bypass valve, the dryer and the connecting tubing) in each U-Line product to be free from defects in materials and workmanship for a period of five years from the date of purchase. During the initial one-year warranty period for all U-Line products U-Line shall: (1) at U-Lines option, repair any product or replace any part of a product that breaches this warranty; and (2) for all Marine, RV and Domestic U-Line products sold and serviced in the United States (including Alaska and Hawaii) and Canada, U-Line shall cover the labor costs incurred in connection with the replacement of any defective part. During years two through five of the warranty period for the sealed system, U-Line shall: (1) repair or replace any part of the sealed system that breaches this warranty; and (2) for all Marine, RV and Domestic U-Line products sold and serviced in the United States (including Alaska and Hawaii) and Canada, U-Line shall cover the labor costs incurred in connection with the replacement of any defective part of the sealed system. All other charges, including transportation charges for replacements under this warranty and labor costs not specifically covered by this warranty, shall be borne by you. This warranty is extended only to the original purchaser of the U-Line product. The Registration Card included with the product should be promptly completed by you and mailed back to U-Line or you can register on-line at [www.U-LineService.com](http://www.U-LineService.com).

The following are excluded from this limited warranty: installation charges; damages caused by disasters or acts of God, such as fire, floods, wind and lightening; damages incurred or resulting from shipping, improper installation, unauthorized modification, or misuse/abuse of the product; customer education calls; food loss/spoilage; door and water level adjustments (except during the first 90 days from the date of purchase); defrosting the product; adjusting the controls; door reversal; or cleaning the condenser.

If a product defect is discovered during the applicable warranty period, you must promptly notify either the dealer from whom you purchased the product or U-Line at P.O. Box 245040, Milwaukee, Wisconsin 53224 or at 414-354-0300. In no event shall such notification be received later than 30 days after the expiration of the applicable warranty period. U-Line may require that defective parts be returned, at your expense, to U-Lines factory in Milwaukee, Wisconsin, for inspection. Any action by you for breach of warranty must be commenced within one year after the expiration of the applicable warranty period.

**This limited warranty is in lieu of any other warranty, express or implied, including, but not limited to any implied warranty of merchantability or fitness for a particular purpose; provided however, that to the extent required by law, implied warranties are included but do not extend beyond the duration of the express warranty first set forth above. U-Lines sole liability and your exclusive remedy under this warranty is set forth in the initial paragraph above. U-Line shall have no liability whatsoever for any incidental, consequential or special damages arising from the sale, use or installation of the product or from any other cause whatsoever, whether based on warranty (express or implied) or otherwise based on contract, tort or any other theory of liability.**

Some states do not allow limitations on how long an implied warranty lasts or the exclusion or limitation of incidental or consequential damages, so the above limitations may not apply to you. This warranty gives you specific legal rights, and you may also have other rights which vary from state to state.



**For General Inquiries:**

P.O. Box 245040  
Milwaukee, Wisconsin  
53224-9540 U.S.A.  
Phone (800) 779-2547  
FAX (414) 354-5696  
www.U-Line.com

**For Service and Parts Assistance:**

Phone (800) 779-2547  
(414) 354-0300  
FAX (414) 354-5696  
Email:  
OnLineService@U-Line.com  
www.U-LineService.com  
E-mail:  
OnlineParts@u-line.com

# *Echelon Series*

For more than four decades, U-Line has distinguished itself as the leader in built-in under-counter ice making, refrigeration and wine storage appliances.

An **INSTALLATION MANUAL** for your unit, providing complete installation information, is available for download at [www.U-Line.com](http://www.U-Line.com). Information for custom panel inserts per model, including panel size, and instructions are available by visiting [www.U-Line.com](http://www.U-Line.com).

When you need replacement parts, always request genuine U-Line replacements be used. Visit [www.U-Line.com](http://www.U-Line.com) to locate a parts distributor in your area.

## *Echelon Series / Origins Series*

U-Line Corporation, located in Milwaukee, WI, is a family operated manufacturer of built-in undercounter ice makers, Combo® ice maker/refrigerators, Wine Captain® wine storage units, refrigerators, refrigerated drawers and refrigerator/freezers.



## Free Manuals Download Website

<http://myh66.com>

<http://usermanuals.us>

<http://www.somanuals.com>

<http://www.4manuals.cc>

<http://www.manual-lib.com>

<http://www.404manual.com>

<http://www.luxmanual.com>

<http://aubethermostatmanual.com>

Golf course search by state

<http://golfingnear.com>

Email search by domain

<http://emailbydomain.com>

Auto manuals search

<http://auto.somanuals.com>

TV manuals search

<http://tv.somanuals.com>