

---

---

# CONTENTS

---

---

<b>Important Safety Instructions</b> . . . . .	3
<b>Introduction</b> . . . . .	5
Features . . . . .	5
<b>Included with Your XCA4500</b> . . . . .	6
<b>Important Electrical Considerations</b> . . . . .	7
Range . . . . .	7
Telephone Line Problems . . . . .	7
Radio Interference . . . . .	8
More Than One Cordless Telephone . . . . .	8
<b>Installation</b> . . . . .	9
Selecting a Location . . . . .	9
Telephone Line Outlets . . . . .	9
Connecting the Telephone Cords . . . . .	10
Applying Power to the Base Unit . . . . .	10
Installing the Backup Battery . . . . .	11
Desk or Tabletop Installation . . . . .	12
Wall Installation . . . . .	14
<b>Setting up Your Phone</b> . . . . .	22
Extending the Antenna . . . . .	22
Installing the Handset Battery Pack . . . . .	22
Cleaning the Battery Contacts . . . . .	24
Charging the Handset Battery Pack . . . . .	25
Low Battery Indicator . . . . .	26
Setting the Pulse/Tone Switch . . . . .	27
Adjusting Ringer Controls . . . . .	27
Automatic Digital Code Security . . . . .	29
<b>Using Your Phone</b> . . . . .	31
Making and Receiving Calls . . . . .	31
Changing Channels, Flash, and Page/Find . . . . .	32
<b>Using the Two-Way Intercom</b> . . . . .	33
Two-Way Paging . . . . .	33
Room Monitor Feature . . . . .	35
<b>Programming Your Phone</b> . . . . .	36
Storing a Number in Memory . . . . .	36
Storing a Mixed Number with a Pulse System . . . . .	38
Storing One-Touch Dialing Numbers . . . . .	39
Dialing a Stored Number . . . . .	41
Chain Dialing . . . . .	41
Erasing a Stored Number . . . . .	42
<b>The Integrated Answering System</b> . . . . .	43
Features . . . . .	43
<b>Answering System Setup</b> . . . . .	44
Turning the Answering System On/Off . . . . .	44

Setting the Clock . . . . .	46
Reviewing Time and Day Stamp . . . . .	48
Base Operation. . . . .	49
Setting Your Outgoing Message (OGM). . . . .	49
Selecting a Preset OGM. . . . .	53
Setting the Calling Party Control Switch. . . . .	54
Setting the Toll Saver Switch . . . . .	54
Using the Reset Button. . . . .	55
<b>Using Your Answering System. . . . .</b>	<b>56</b>
Playing New Messages . . . . .	56
Playing a Stored Message . . . . .	58
Repeating a Message. . . . .	60
Skipping a Message . . . . .	62
Deleting a Message . . . . .	65
Deleting All Messages . . . . .	70
Message Full Indication . . . . .	71
Voice-Guided Help Menu . . . . .	72
Screening Incoming Calls. . . . .	73
Leaving a Memo Message . . . . .	74
Recording a Telephone Conversation . . . . .	76
<b>Remote Operation . . . . .</b>	<b>77</b>
Setting Your PIN Code . . . . .	77
Using a Touch-Tone Phone . . . . .	79
<b>Troubleshooting. . . . .</b>	<b>81</b>
Telephone Troubleshooting Chart . . . . .	81
Answering System Troubleshooting Chart. . . . .	82
<b>Specifications. . . . .</b>	<b>83</b>

---

---

## Important Safety Instructions

---

---

When using your telephone equipment, these basic safety precautions should always be followed to reduce the risk of fire, electrical shock, and injury to persons:

1. Read and understand all instructions.
2. Follow all warnings and instructions marked on the product.
3. Unplug this product from the wall outlet before cleaning. Use a dry cloth for cleaning without liquid or aerosol cleaners.
4. Do not use this product near water; for example, near a bathtub, wash bowl, kitchen sink or laundry tub, in a wet basement, or near a swimming pool.
5. Do not place this product on an unstable cart, stand, or table. The telephone may fall, causing serious damage to the unit.
6. Slots and openings in the cabinet and the back or bottom are provided for ventilation. To protect the product from overheating, these openings must not be blocked or covered. This product should never be placed near or over a radiator or heat register. This product should not be placed in a built-in installation unless proper ventilation is provided.
7. This product should be operated only from the type of power source indicated on the marking label. If you are not sure of the type of power supply to your home, consult your dealer or local power company.
8. Do not allow anything to rest on the power cord. Do not locate this product where the cord will be damaged by persons walking on it.
9. Do not overload wall outlets and extension cords, as this can result in the risk of fire or electric shock.
10. Never push objects of any kind into this product through cabinet slots, as they may touch dangerous voltage points or short out parts that could result in a risk of fire or electric shock. Never spill liquid of any kind on the product.
11. To reduce the risk of electric shock, do not disassemble this product. Take it to qualified service personnel when service or repair work is required. Opening or removing covers may expose you to dangerous voltages or other risks. Incorrect reassembly can cause electric shock when the appliance is subsequently used.

12. Unplug this product from the wall outlet and refer servicing to qualified service personnel under the following conditions:
  - A. When the power supply cord is damaged or frayed.
  - B. If liquid has been spilled into the product.
  - C. If the product has been exposed to rain or water.
  - D. If the product does not operate normally when following the operating instructions. (Adjust only those controls that are covered by the operating instructions. Improper adjustment of other controls may result in damage and will often require extensive repair work by a qualified technician.)
  - E. If the product has been dropped or the cabinet has been damaged.
  - F. If the product exhibits a distinct change in performance.
13. Do not use the telephone to report a gas leak in the vicinity of the leak.

**Caution:** *To reduce the risk of fire or injury to persons by the battery, read and follow these instructions.*

1. Use only the appropriate type and size Battery Pack specified in this Operating Guide.
2. Do not dispose of the Battery Pack in a fire. The cell may explode. Check the Nickel-Cadmium Battery Disposal package insert for disposal instructions.
3. Do not open or mutilate the Battery Pack. Released electrolyte is corrosive and may cause damage to the eyes or skin. It may be toxic if swallowed.
4. Exercise care in handling the battery in order not to short the battery with conducting materials such as rings, bracelets, and keys. The battery or conductor may overheat and cause burns.
5. Charge the Battery Pack provided with or identified for use with this product only in accordance with the instructions and limitations specified in the instruction manual provided for this product.
6. Observe proper polarity orientation between the Battery Pack and battery charger.

**SAVE THESE INSTRUCTIONS**

---

---

## Introduction

---

---

Congratulations on your purchase of a Uniden **XCA4500** Integrated Telephone Answering Device. Your new telephone answering device is designed to exacting standards to provide reliability, long life, and outstanding performance.

### Features

- 25 44/49 MHz Channels
- Random Code™ Digital Security
- UltraClear Plus
- AutoTalk™
- 10 Number Memory
- Redial/Pause and Flash
- Reversible Handset Retainer
- Integrated Answering System
- AutoSecure™
- Pulse/Tone Dialing
- AutoStandby™
- 2 One-Touch Dialing Buttons
- Two-Way Page/Intercom
- Handset Ringer/Volume Controls

The **XCA4500** has a built-in telephone Answering System so you'll never miss another important call. Unlike other Answering Systems, you can perform all of the functions using either your Handset or Base Unit, including recording a new outgoing message, monitoring incoming calls, and playing and deleting your messages.

*AutoTalk™* allows you to answer a call by just removing the Handset from the Base, so you don't have to waste time pushing buttons or flipping switches. *AutoStandby™* allows you to hang up by simply returning the Handset to the Base.

The *UltraClear Plus* true compander circuitry virtually eliminates background noise, and the *25 Channel Auto-Scan* monitors multiple channels and automatically selects the best channel to assure crystal clear transmissions. Together, these innovations give you the best possible reception during all your conversations.

To protect you against misbilled calls which might result from your phone being activated by other equipment, the **XCA4500** has *Random Code™* digital security which automatically selects one of over 65 thousand digital security codes for the Handset and Base Unit. Also, the *AutoSecure™* feature electronically locks your phone when the Handset is in the Base.

To get the most from your phone, ***please read*** this Operating Guide thoroughly. Also be sure to complete the Product Registration Form and mail it in.

---

---

## Included with Your **XCA4500**

---

---

*If any of these items are missing or damaged, do not contact the place of purchase. Instead contact Uniden Customer Service at: (800) 297-1023, 8:00 a.m. to 5:00 p.m., Central, Monday through Friday.*



Handset



Base Unit



AC Adapter



Long Telephone  
Cord



Rechargeable  
Handset Battery

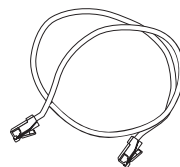

Short Telephone  
Cord



Operating Guide

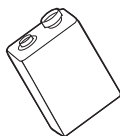

9V Backup Battery



Other Printed  
Material

---

---

## Important Electrical Considerations

---

---

Unplug all electrical appliances when you know an electrical storm is approaching. Lightning can pass through your household wiring and damage any device connected to it. This unit is no exception.

**Warning:** *Please do not attempt to unplug any appliance during an*

electrical storm.

**Caution:** *Changes or modifications to this product not expressly approved by Uniden, or operation of this product in any way other than as detailed by this Operating Guide, could void your authority to operate this product.*

### Range

This unit is designed to achieve the maximum possible range by transmitting and receiving according to the highest specifications set forth by the I.C. We have rated this phone to operate at a maximum distance with the qualification that the range depends upon the environment in which the telephone is used. Many factors limit range, and it would be impossible to include all the variables in our rating. The Maximum Range rating of your integrated telephone answering device is meant to be used as a means of comparison against other range claims.

### Telephone Line Problems

The FCC has granted the telephone company the right to disconnect service in the event that your phone causes problems on the telephone line. Also, the telephone company may make changes in facilities and services which may affect the operation of your unit. However, your telephone company must give adequate notice in writing prior to such actions to allow you time for making necessary arrangements to continue uninterrupted service.

If you are having trouble with your telephone service, you must first disconnect your phone to determine if it is the cause of your problem. If you determine that it is the cause, you must leave it disconnected until the trouble has been corrected.

## **Radio Interference**

Radio interference may occasionally cause buzzing and humming in your cordless Handset or clicking noises in the Base Unit. This interference is caused by external sources such as TV, refrigerator, vacuum cleaner, fluorescent lighting, or electrical storms. Your unit is NOT DEFECTIVE. If these noises continue and are too distracting, please check around your home to see what appliances may be causing the problem. In addition, we recommend that the Base Unit not be plugged into a circuit that also powers a major appliance because of the potential for interference. Be certain that the antenna on the unit is fully extended when needed.

In the unlikely event that you consistently hear other voices or distracting transmissions on your phone, you may be receiving radio signals from another cordless telephone or other source of interference. If you cannot eliminate this type of interference, you need to change to a different channel.

Finally, it should be noted that some cordless telephones operate at frequencies that may cause interference to nearby TVs and VCRs; to minimize or prevent such interference, the base of the cordless telephone should not be placed near or on top of a TV or VCR; and, if interference is experienced, moving the cordless telephone farther away from the TV or VCR will often reduce or eliminate the interference.

## **More Than One Cordless Telephone**

If you want to use more than one cordless telephone in your home, they must operate on different channels. Press the channel key to select a channel that provides the clearest communication.



---

---

# Installation

---

---

## Selecting a Location

Before choosing a location for your **XCA4500**, there are some important guidelines you should consider:

- The location should be close to both a phone jack and continuous power outlet. (A continuous power outlet is an AC outlet which does not have a switch to interrupt its power.)
- Keep the Base Unit and Handset away from sources of electrical noise such as motors or fluorescent lighting.
- Be sure there is sufficient space to fully extend the Base Unit antenna.
- The Base Unit can be placed on a desk or tabletop or mounted on a standard AT&T or GTE wall plate.
- If you decide to mount your integrated telephone answering device on the wall, make sure to change the handset retainer so that the tab which holds the Handset faces up. (See page 20 for more information.)
- You should charge your new phone for 15-20 hours before completing the installation or using the Handset.

## Telephone Line Outlets

There are two types of phone outlets:

### Modular Jack

Most phone equipment available now uses modular jacks. Phone cords are fitted with a molded plastic connector which plugs into this type of jack. If you do not have modular phone jacks, contact your local telephone company for information about their installation.

### Hard-wired Jack

Some equipment is wired directly to a phone jack, and these types of installations require a modular jack converter. This type of installation is not difficult; however, you should contact your Uniden telephone dealer or a telephone supply store for advice about the proper adapter or converter for your particular situation.

## Connecting the Telephone Cords

Consider these safety guidelines before connecting the telephone cords:

### CAUTION:

- Never install telephone wiring during a lightning storm.
- Never touch uninsulated telephone wires or terminals unless the telephone line has been disconnected.
- Use caution when installing or modifying telephone lines.

## Applying Power to the Base Unit

The **XCA4500** requires a standard electrical outlet (120 volts AC without a switch to interrupt power) and the included AC adapter. Connect the adapter as shown below.

1. Wrap the power cord around the convenient notch on the bottom.

**Important:** Place the power cord so that it does not create a trip hazard, or where it could become chafed and create a fire or other electrical hazards.

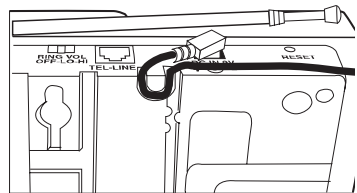

2. When power is first applied, the Message Counter LED display flashes **P** quickly while the system's memory initializes. When the flashing slows, press the **STOP** button on the Base Unit.

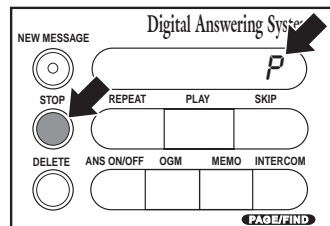

3. The Message Counter LED display turns off, and the time and remaining message record time are announced.

**Note:** For information about turning the Answering System On/Off, see page 46.

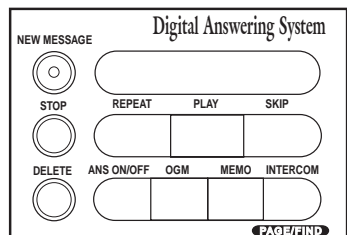

## Installing the Backup Battery

In the event of a power outage, your phone has a 9-volt battery backup which can prevent the loss of your messages for up to four hours.

1. Press down and away from the Base to remove the cover.

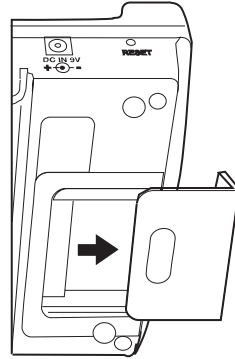

2. Place the battery in the compartment.

**Note:** Make sure that the positive battery terminal touches the left contact.

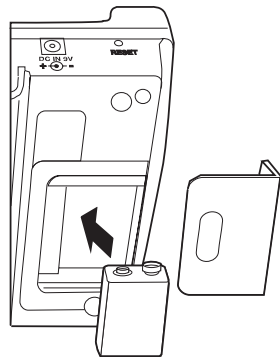

3. Replace the battery cover.

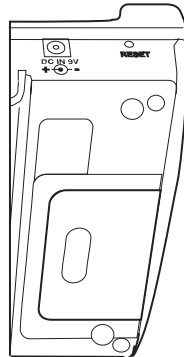

## Desk or Tabletop Installation

1. Place the Base on a desk or tabletop.

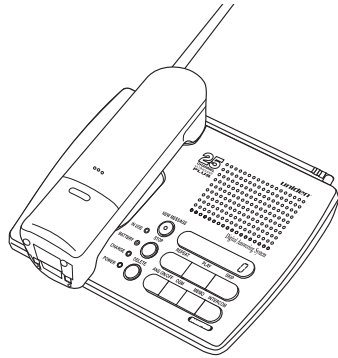

2. Plug the AC Adapter into the Base Unit.

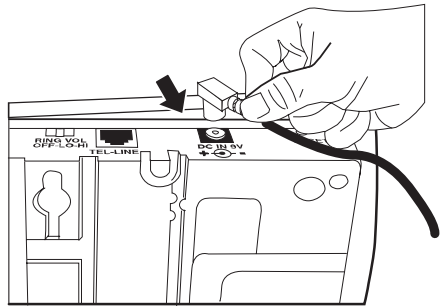

3. Place the AC Adapter cord inside the molded channel.

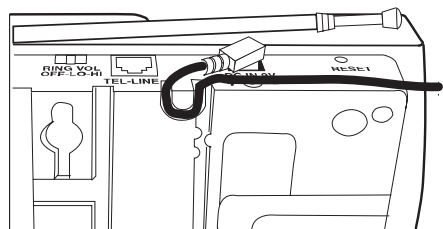

4. Plug one end of the long telephone cord into the **TEL LINE** jack on the Base Unit.

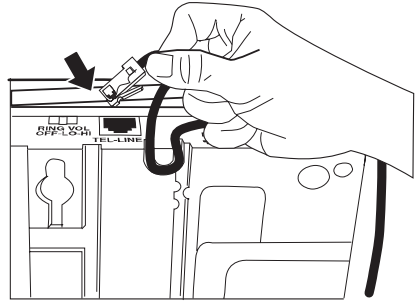

5. Plug the other end of the cord into the telephone jack on the wall.

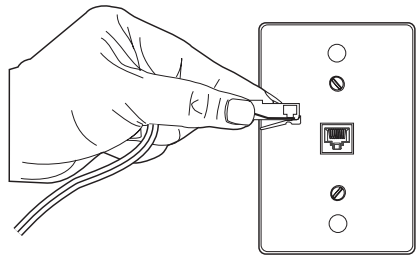

6. Plug the AC Adapter into a standard 120V AC wall outlet.

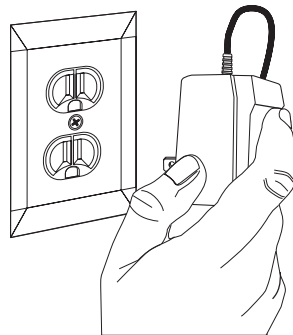

## Placement of the Handset

The unique design of your phone allows you to place the Handset on the Base Unit either face down or in an upright position. The battery charges in either position.

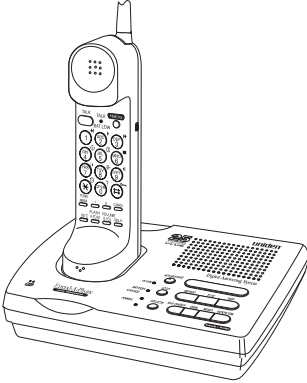

Upright Position for  
Handset

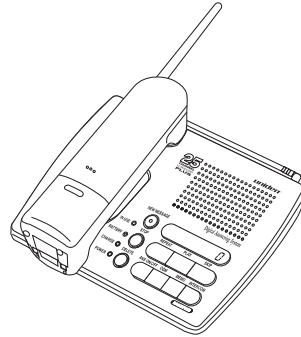

Facedown Position for  
Handset

## Wall Installation

### Standard Wall Plate Mounting

The XCA4500 is designed to be mounted on a standard AT&T or GTE wall plate.

1. Plug the AC Adapter into the Base Unit.

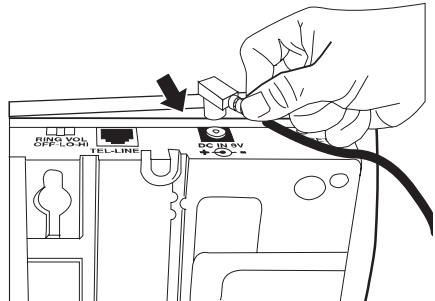

2. Place the AC Adapter cord inside the molded channel.

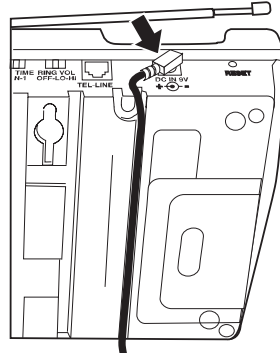

3. Plug one end of the short telephone cord into the **TEL LINE** jack on the Base Unit.

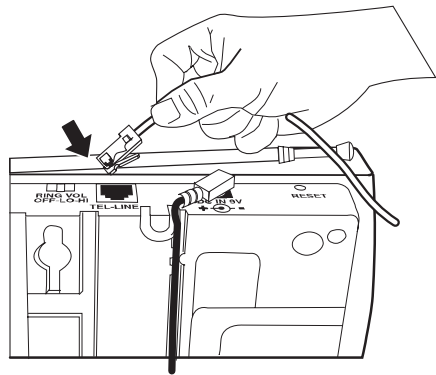

4. Place the telephone cord inside the molded channel on the bottom of the Base Unit.

Then plug the other end of the telephone cord into the modular jack on the wall.

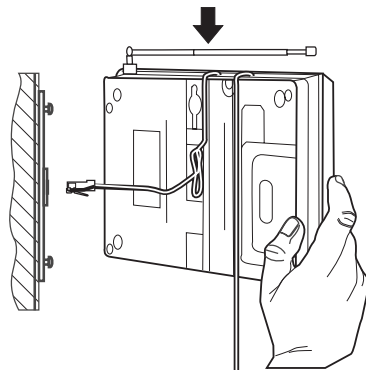

5. Place the Base Unit on the posts of the wall plate and push down until it's firmly seated.

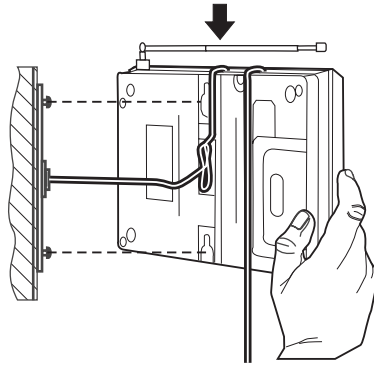

6. Plug the AC Adapter into a standard 120V AC wall outlet.

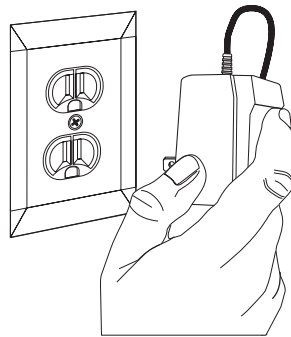



## Direct Wall Mounting

If you do not have a standard wall plate, you can mount the **XCA4500** directly on a wall. Before mounting your integrated telephone answering device, consider the following:

- Select a location away from electrical cables, pipes, or other items behind the mounting location that could cause a hazard when inserting screws into the wall.
  - Make sure the wall material is capable of supporting the weight of the Base Unit and Handset.
  - Use #10 screws with anchoring devices suitable for the wall material where the Base Unit will be placed.
1. Insert two mounting screws  $3\frac{15}{16}$  inches apart. Allow about  $\frac{1}{5}$  of an inch between the wall and screw heads for mounting the phone.

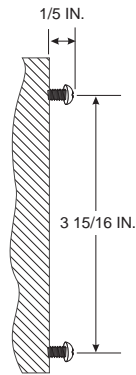

2. Plug the AC Adapter into the Base Unit.

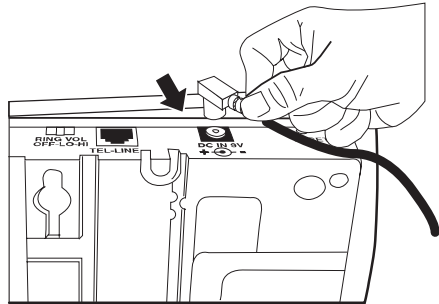

3. Place the AC Adapter cord inside the molded channel.

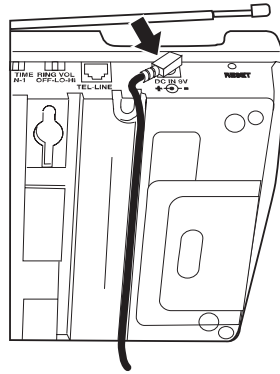

4. Plug one end of the long telephone cord into the **TEL LINE** jack on the Base Unit.

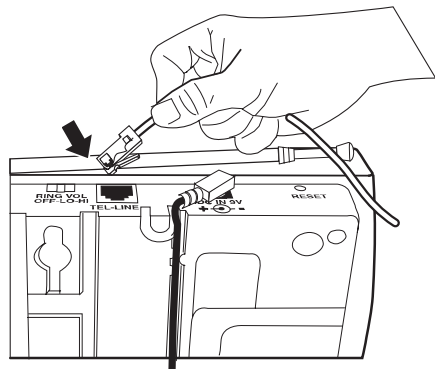

5. Place the cord inside the molded channel on the bottom of the Base Unit.

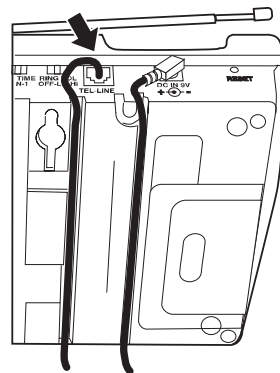

6. Place the Base Unit on the screws and push down until it's firmly seated.

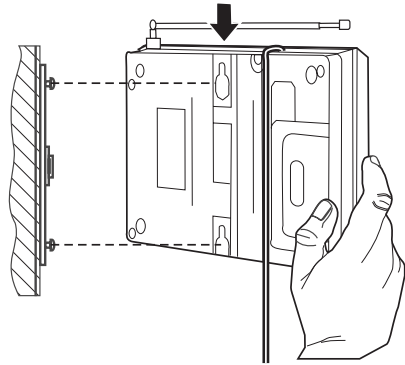

7. Plug the other end of the telephone line cord into the wall jack.

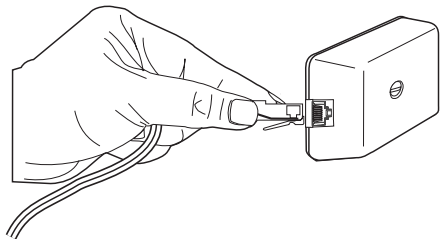

8. Plug the AC Adapter into a standard 120V AC wall outlet.

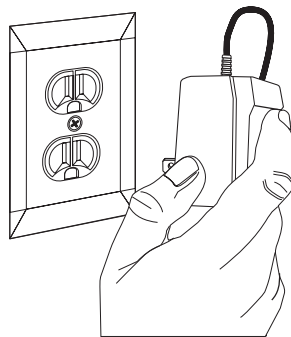

## Setting the Handset Retainer

The Handset Retainer holds the Handset in place if your phone is mounted on a wall. These steps describe how to remove and replace the retainer so that the tab faces up.

1. Push up on the Handset Retainer on the Base Unit, and slide the tab out.

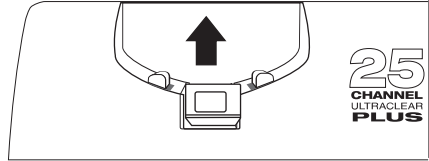

2. Flip the Retainer over so the tab faces up.

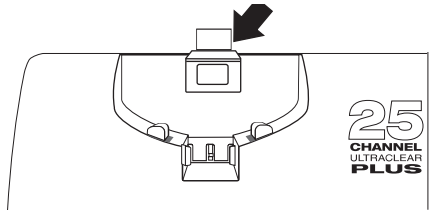
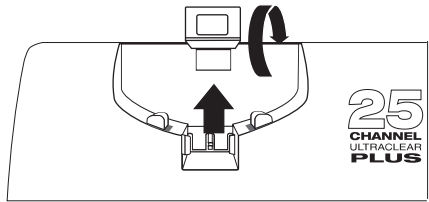

- Put the Retainer back into its slot on the Base Unit.

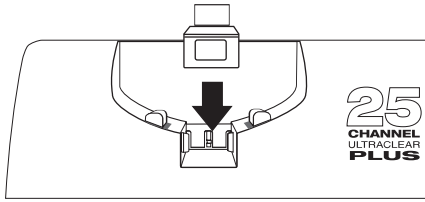

- Push down on the Handset Retainer until it snaps into place.

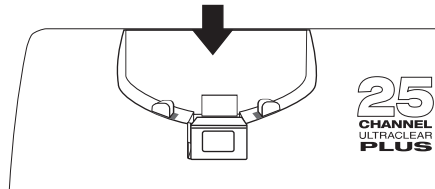

---

---

## Setting up Your Phone

---

---

### Extending the Antenna

Before using your phone, be sure to raise its Antenna to the vertical position, and then extend the Antenna.

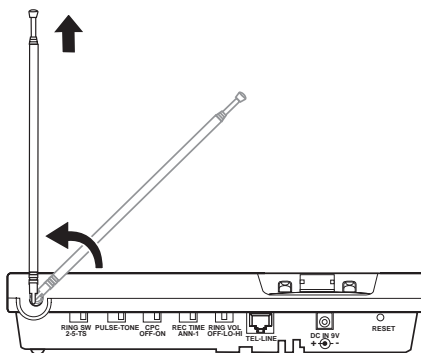

### Installing the Handset Battery Pack

1. Press in on the Battery Cover Release.

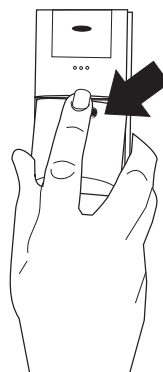

- Slide the Battery Compartment cover down.

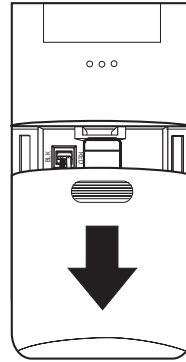

- Align the plastic connector of the Nickel-Cadmium Battery Pack with its socket and plug it in.

**Warning:** Always install Battery Cable with Black Wire closest to the left.

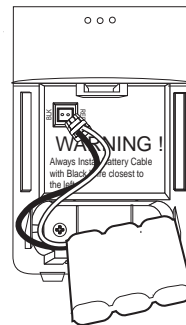

- Place the Battery Pack inside the Battery Compartment, and slide the battery cover back on.

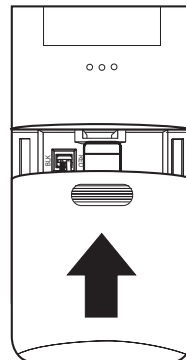

**Note:** The built-in Memory Backup feature allows up to 3 minutes to disconnect the old battery pack and install a new one without losing any phone numbers that may be stored in the telephone's memory.

## Cleaning the Battery Contacts

To maintain a good charge, it is important to clean all charging contacts on the Handset and Base Unit about once a month. Use a pencil eraser or other contact cleaner. **Do not** use any liquids or solvents.

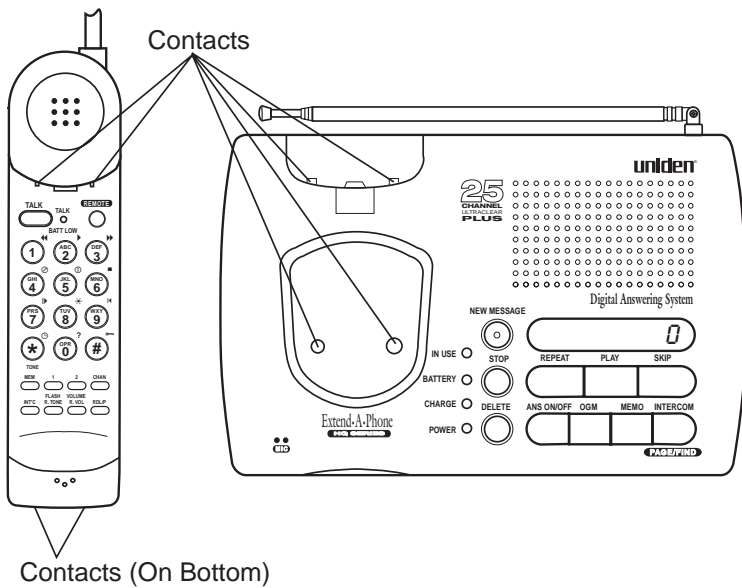



# Charging the Handset Battery Pack

## Initial Battery Charging

The rechargeable Nickel-Cadmium battery pack must be fully charged before using your phone for the first time. We recommend that the battery pack charge for approximately 15-20 hours, without interruption, before plugging the phone line into your new phone.

1. Place the Handset on the Base Unit. Depending on your installation, you can charge the Handset in the upright position.

—OR—

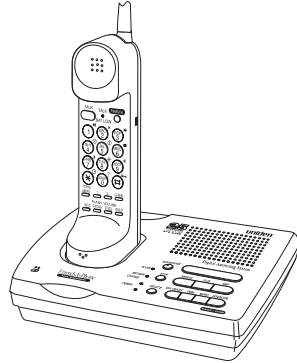

You can charge the Handset in its facedown position.

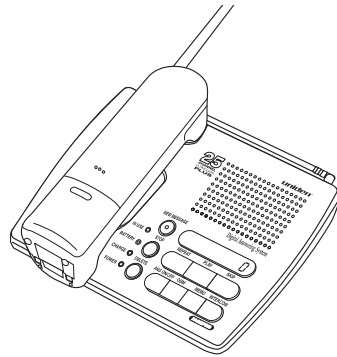

2. Make sure the **CHARGE** LED lights. If the LED doesn't light, check to see that the AC Adapter is plugged in and that the Handset is making good contact with the Base Unit charging contacts.

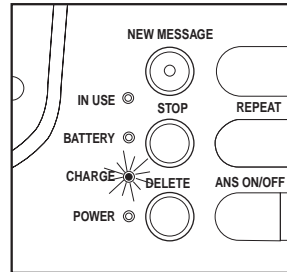

### Continuous Battery Charging

For the best battery performance, return the Handset to the Base Unit at the end of the day to keep the battery fully charged.

### Low Battery Indicator

When the Battery Pack in the Handset is very low and needs to be charged, the **TALK/BATT LOW** LED flashes.



If the **TALK/BATT LOW** LED begins to flash, the phone is programmed to eliminate its functions to save power. The table below describes what to do to return your phone to normal operation.

During a Call	In Standby Mode
Only the <b>TALK</b> button operates.	None of the buttons will operate.
The Handset beeps and the <b>TALK/BATT LOW</b> LED flashes once every three seconds.	The Handset <b>TALK/BATT LOW</b> LED flashes once every three seconds.
Complete your call as quickly as possible.	You will not be able to make a call.
Return the Handset to the Base Unit for charging.	Return the Handset to the Base Unit for charging.

**Note:** Allow 15 to 20 hours without interruption for the Handset to fully recharge.

## Setting the Pulse/Tone Switch

Be sure the **PULSE/TONE** switch is in the **TONE** position if you have touch-tone telephone service.

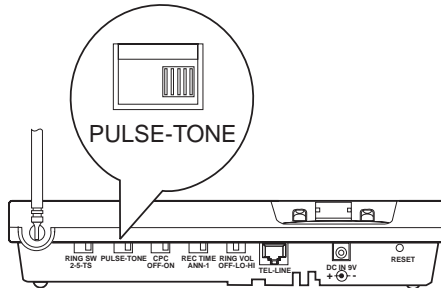

**Note:** Most phone systems are Tone dialing. Check with your local phone company if you are not sure whether your system is Tone or Pulse dialing.

## Adjusting Ringer Controls

### Handset Volume Controls

To adjust the ringer volume of your Handset, press **R.VOL** when the phone is not in use.

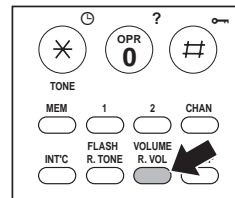

Handset Ringer Volume Control

You can also select one of two different ringer tones for the Handset.

When the phone is not in use, press **R.TONE** to select a different ringer tone.

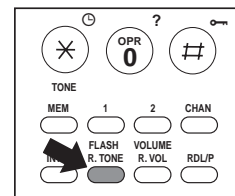

Handset Ringer Tone Select Key

To adjust the receiver volume, press **VOLUME** while you are on a call.

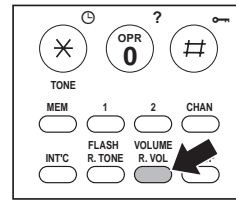

Handset Receiver Volume Control

## Base Volume Controls

To adjust the Base Unit ringer volume, move the **RING-OFF LO HI** switch to the desired setting.

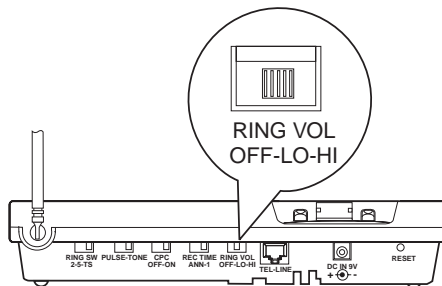

To adjust the Base speaker volume, slide the **VOLUME** control to the desired setting.

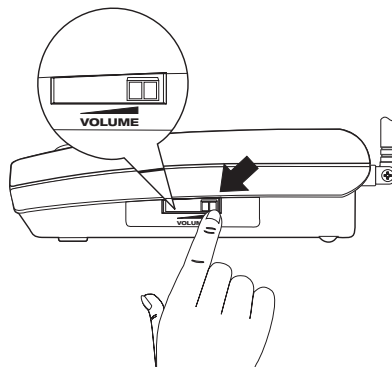

## Automatic Digital Code Security

Many cordless telephones operate similarly and on the same frequency. Without digital code security, another Handset could make calls using your Base Unit and telephone line. To avoid unauthorized calls on your phone, a Digital Code feature was added to the **XCA4500**. This Digital Code is shared only between the Handset and Base Unit. The Code is set *automatically* when you first use the phone.

To reset the Digital Code, be sure the Handset is on the Base, then:

1. Press **INTERCOM** on the Base Unit.

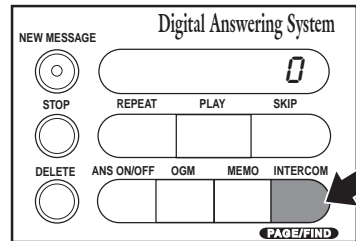

2. Remove the Handset from the Base Unit, and then set it down again.

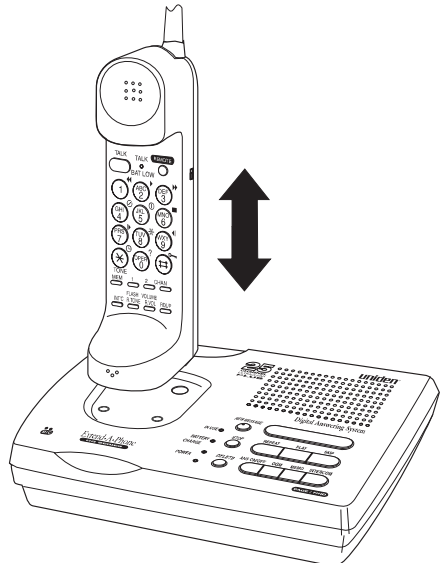

3. The **CHARGE** LED will blink to indicate that the Digital Security Code is set to one of more than 65,000 codes.

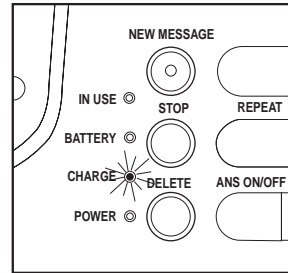

If the Base Unit loses power while the Handset is off the Base, the Digital Code may be erased. When this happens, the Handset will not function. To establish communication between the Handset and Base Unit:

1. Restore power to the Base Unit, and place the Handset back on the Base Unit.

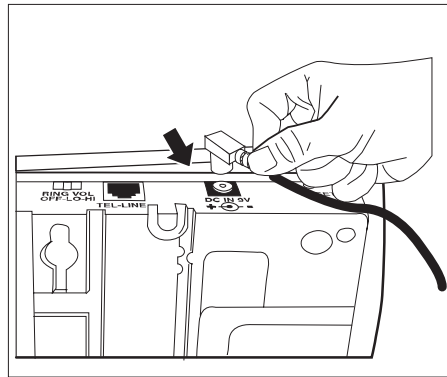

2. The **CHARGE** LED will blink to indicate that the Digital Security Code is set.

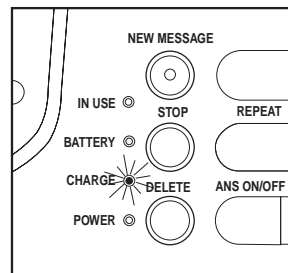

## Using Your Phone

### Making and Receiving Calls

The following features of your **XCA4500** phone are different depending on the Handset's location when you make or receive a call.

	HANDSET ON BASE	HANDSET OFF BASE
<b>ANSWER CALL</b>	Pick up Handset (AutoTalk).	Press <b>TALK</b> .
<b>MAKE CALL</b>	1) Pick up Handset. 2) Press <b>TALK</b> . 3) Listen for dial tone. 4) Dial the number.	1) Press <b>TALK</b> . 2) Listen for dial tone. 3) Dial the number.
<b>HANG UP</b>	Press <b>TALK</b> . — OR — Return Handset to Base (AutoStandby).	
<b>REDIAL</b>	1) Pick up Handset. 2) Press <b>TALK</b> . 3) Listen for dial tone. 4) Press <b>RDL/P</b> .	1) Press <b>TALK</b> . 2) Listen for dial tone. 3) Press <b>RDL/P</b> .

**Note:** Sometimes when you press **TALK** to hang up the phone, you may get an error tone and the phone will not disconnect. If this happens, place the Handset on the Base Unit or press **TALK** again while holding the Handset close to the Base Unit.

## Changing Channels, Flash, and Page/Find

To change channels or access Call Waiting while the phone is in use, or to use the one-way page to locate the Handset, follow these steps:

	<b>PRESS THESE KEYS</b>	<b>YOU WILL HEAR</b>
<b>CHANGING CHANNELS</b>	Press <b>CHANNEL</b> . <i>Note: Change channels to help eliminate background noise.</i>	A click similar to when <b>FLASH</b> is pressed. There may be a brief pause as your phone searches for a clear channel.
<b>FLASH</b>	If the <i>Call Waiting</i> tone sounds, press <b>FLASH</b> to accept the waiting call.  — OR —  If you have finished a call and want to make another call, press <b>FLASH</b> to hang up and get a dial tone.	A click, a short pause, then the caller (if you were on a call).  — OR —  A click, and then a dial tone so you can make a different call.
<b>PAGE/FIND</b>	Press <b>PAGE/FIND</b> on the Base Unit to locate or page the Handset.	The Handset will begin to beep.



---

---

## Using the Two-Way Intercom

---

---

The Two-Way Page/Intercom feature allows you to communicate between the Base Unit and the Handset. To use this feature:

- The **RING ON/BATT SAVE** Switch on the Handset must be in the **RING ON** position.
- The **BASE UNIT RINGER** Switch must be set to either **LO** or **HI**.

**Note:** *If you are on a call while using the Handset and you page the Base Unit, the Base Unit will ring even when the Base Ringer Switch is set to the OFF position.*

### Two-Way Paging

#### Paging the Base Unit

1. Press **INTC** on the Handset.

**Note:** *If there is no answer, press **INTC** again to cancel.*

2. Press **INTERCOM** on the Base Unit to answer page.  
*The **IN USE** and **TALK/BATT LOW** LEDs light.*

#### To end the conversation:

3. Press **TALK** on the Handset or **INTERCOM** on the Base.

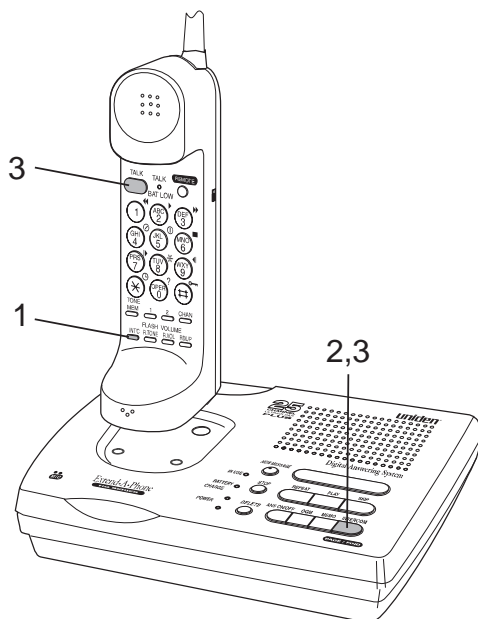

## Paging the Handset

1. Press **INTERCOM** on the Base Unit.

**Note:** If there is no answer, press **INTERCOM** again to cancel.

2. Press **TALK** or **INT'C** on the Handset to answer the page.  
The **IN USE** and **TALK/BATT LOW** LEDs light.

### To end the conversation:

3. Press **INTERCOM** on the Base Unit, or **TALK** the Handset.

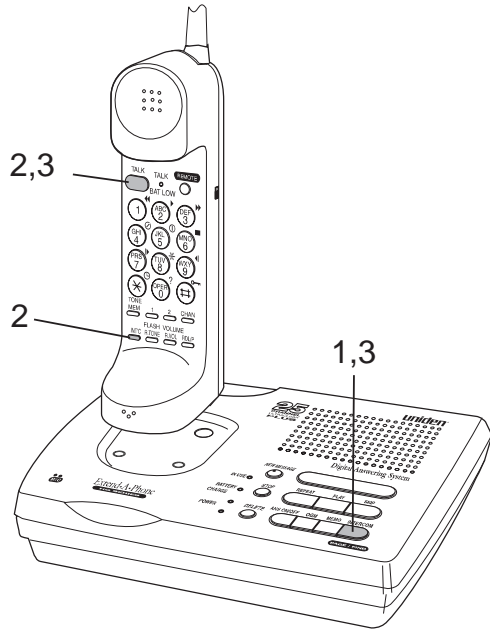

## Room Monitor Feature

Another use of the **XCA4500** is to monitor activity near the Base Unit. To turn the monitor on, follow the steps below.

1. Press **INTC** on the Handset.
2. Press **TALK** on the Handset.

*Note: Using the Handset, you should now be able to monitor the room where the Base Unit is located.*

### To turn the monitor off:

3. Press **TALK** on the Handset.

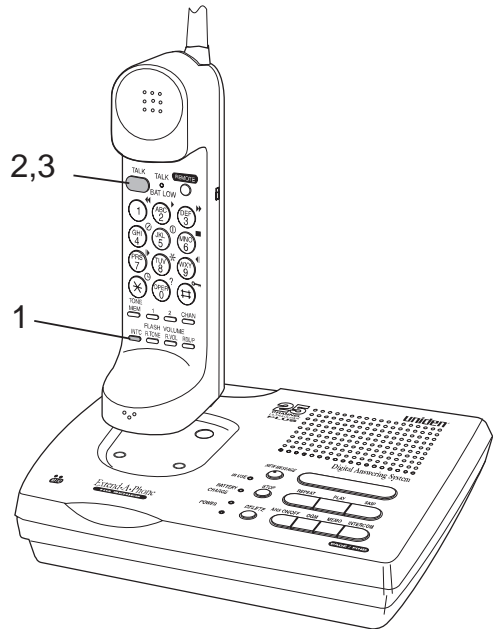

## Programming Your Phone

All programming functions must be completed when your phone is in the Standby mode. The programming keys will not function while you are on the phone.

### Storing a Number in Memory

Use these keys to store a number in memory.

**Note:** An error tone will sound and the programming procedure will be canceled if more than 20 seconds elapse between each keystroke entry or step.



1. Remove the Handset from the Base Unit.
2. Press **MEM** .

*The TALK/BATT LOW LED blinks.*

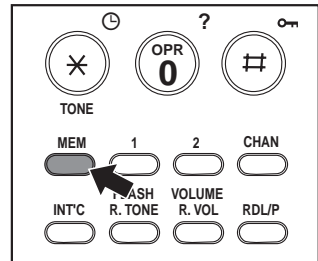

3. Enter the number you want to store (up to 16 digits).



4. If a pause is needed during dialing to access a long distance service, press

**RDL/P** .

**9** **RDL/P** **5** **5** **5** **1** **2** **1** **2**

**Note:** The **RDL/P** button counts as one digit. Pressing **RDL/P** more than once increases the length of the pause between numbers.

5. Press **MEM** again.
6. Enter the memory location (0-9).

*A tone indicates that the number is stored.*

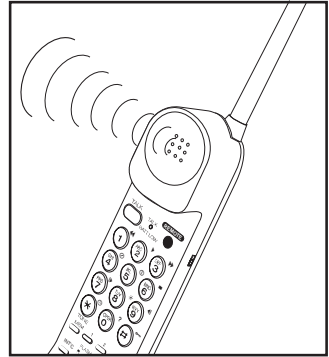

## Storing a Mixed Number with a Pulse System

If your phone is set up for pulse dialing, you can store a mixed mode number so that you can easily access long distance services.

Use these keys to store a mixed mode number in memory.

**Note:** An error tone will sound and the programming procedure will be canceled if more than 20 seconds elapse between each keystroke entry or step.



1. Remove the Handset from the Base Unit.
2. Press **MEM** .

The **TALK/BATT LOW LED** blinks.

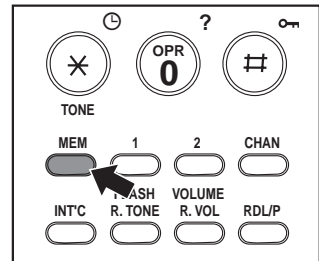

3. Enter the number to be dialed in pulse mode.

**5 5 5 1 2 1 2**

4. Press **TONE** on the Handset.

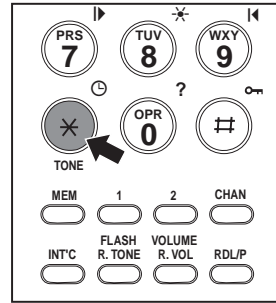

5. Enter the number to be dialed in Tone mode.



6. If a pause is needed during dialing to access a long distance service, press



**Note:** The **RDL/P** button counts as one digit. Pressing **RDL/P** more than once increases the length of the pause between numbers.

7. Press **MEM** again.
8. Enter the memory location (0-9).  
A tone indicates that the number is stored.

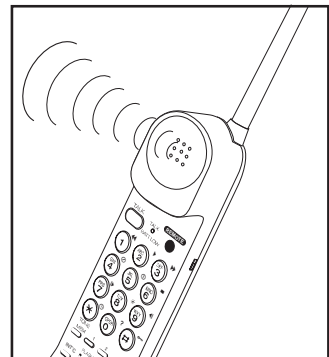

## Storing One-Touch Dialing Numbers

Use these keys to store a number in a One-Touch dialing button.

**Note:** An error tone will sound and the programming procedure will be canceled if more than 20 seconds elapse between each keystroke



1. Remove the Handset from the Base Unit.
2. Press **MEM** .  
The **TALK/BATT LOW LED** blinks.

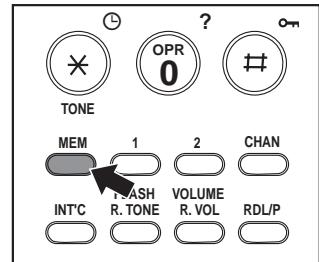

3. Enter the number you want to store (up to 16 digits).
4. If a pause is needed during dialing to access a long distance service, press **RDLP** .

**5 5 5 1 2 1 2**

**9 RDLP 5 5 5 1 2 1 2**

**Note:** The **RDLP** button counts as one digit. Pressing **RDLP** more than once increases the length of the pause between numbers.



6. Now press the One-Touch Dialing button (1 or 2) you want to program.  
*A tone indicates that the number is stored.*

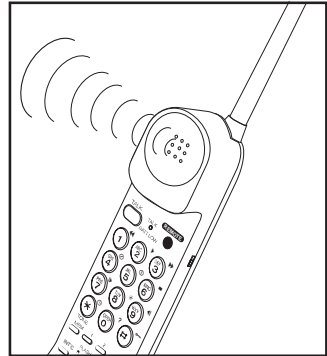

## Dialing a Stored Number

To dial a number previously stored in memory, follow these steps:

MEMORY DIALING	ONE-TOUCH DIALING KEYS
Remove the Handset from the Base Unit.	Remove the Handset from the Base Unit.
Press <b>TALK</b> .	Press <b>TALK</b> .
Press <b>MEM</b> .	Press the One-Touch Dialing button where the number is stored.
Press the memory location number (0-9).	

## Chain Dialing

On certain occasions, after dialing a number, you may be requested by the party or service you are calling to enter a special access code, such as when performing a banking transaction. To do this, simply:

1. Store the access code into one of the memory locations.
2. Dial the main number.
3. At the appropriate time, press **MEM** followed by the memory location number or One-Touch Dialing button where the access code is saved.

## Erasing a Stored Number

To erase a number previously stored in a memory location (0-9) or in One-Touch memory, follow these steps:

MEMORY	ONE-TOUCH KEYS
Remove the Handset from the Base Unit.	Remove the Handset from the Base Unit.
Press <b>MEM</b> twice.	Press <b>MEM</b> twice.
Press the memory location number (0-9).	Press the One-Touch Dialing button you want to clear.

**Note:** *An error tone will sound and the erase procedure will be canceled if more than 20 seconds elapse between each keystroke entry or step.*

---

---

## The Integrated Answering System

---

---

The **XCA4500** has a *built-in* Answering System which answers incoming calls and records your messages. You can also use your new Answering System to record a conversation, leave a memo message for someone else who will use the phone, or to announce a special message when you'll be away from your phone.

### Features

- *Digital Tapeless Recording*
- *Remote Operation from Handset*
- *Selectable Outgoing Messages*
- *Voice-Guided Help Menu*
- *Time and Day Stamp*
- *More than 12 Minutes Record Time*
- *Call Screening*
- *Calling Party Control*
- *Battery Memory Backup*
- *Toll Saver*

Digital Tapeless Recording allows you to quickly review your messages, saving or deleting the messages you choose. You'll never have to worry about a tape wearing out or resetting properly.

There is also a Voice-Guided Help Menu available when operating the remote keys from the Handset. By simply pressing one button, you can review all of the function keys on the Handset. You won't have to worry about finding a quick reference card because help is really at your fingertips.

Your **XCA4500** is an advanced, integrated system which offers you maximum flexibility, but ***please read*** through the sections that explain all of the features before using your Answering System.

---

---

## Answering System Setup

---

---

### Turning the Answering System On/Off

#### Handset Operation

1. To turn the Answering System ON, press **REMOTE** .

*The TALK/BATT LOW LED lights orange. The current Time and Day Stamp and number of messages recorded is announced in the Handset receiver.*



2. Press ①

*You will hear a tone in the Handset followed by the announcement: "Answering System on."*

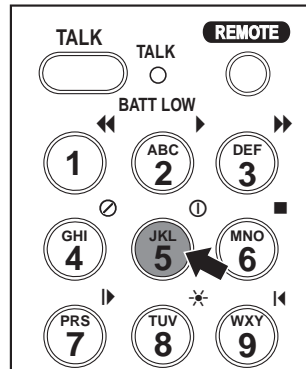

3. Press **REMOTE** again to return to Standby.

*The TALK/BATT LOW LED turns off.*

- To turn the Answering System **OFF**, press **REMOTE** .

*The **TALK/BATT LOW LED** lights orange. The current Time and Day Stamp and number of messages recorded is announced on the Handset receiver.*

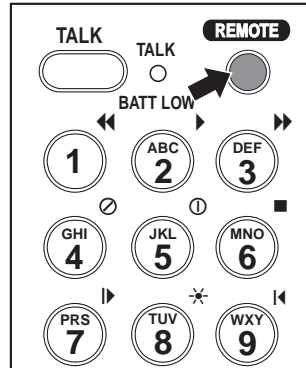

- Press ①

*You will hear a tone in the Handset followed by the announcement: "Answering System off."*

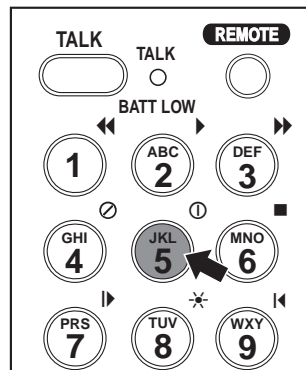

- Press **REMOTE** again to return to Standby.

*The **TALK/BATT LOW LED** turns off.*

## Base Operation

1. To turn the Answering System **ON**, press **ANS ON/OFF**.

*A tone sounds, and the current outgoing message plays on the Base Unit speaker. A second tone sounds to indicate the unit is ready to answer calls, and the Message Counter LED turns on.*

2. To turn the Answering System **OFF**, press **ANS ON/OFF** again.

*A tone sounds and the Message Counter LED turns off.*

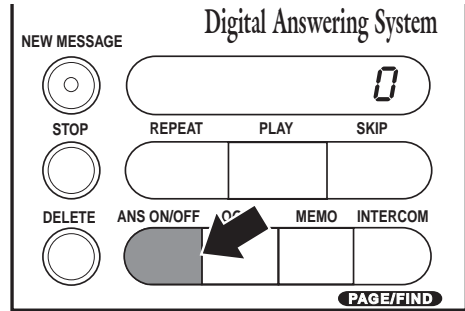

## Setting the Clock

The clock in your **xca4500** Answering System starts when power is applied to the Base Unit. Follow these steps to set the clock to the correct time.

1. Press **REMOTE** on the Handset.

*The TALK/BATT LOW LED lights orange.*



2. Press 

Then enter the number which corresponds to the day.

Day of the Week	Press
Sunday	1
Monday	2
Tuesday	3
Wednesday	4
Thursday	5
Friday	6
Saturday	7

3. Enter the two-digit number for the hour (01-12) and the minute (00-59).

4. To set a.m., press 

To set p.m., press 

**Note:** A beep indicates the new time is programmed, and the new Time and Day Stamp is announced in the Handset receiver.

5. Press **REMOTE** to return to Standby.

6. For example, to set Tuesday at 3:20 p.m., press **REMOTE** followed by these keys.



**Note:** Remember to press **REMOTE** again to return to Standby.

# Reviewing Time and Day Stamp

## Handset Operation

1. Press **REMOTE** to hear the current Time and Day Stamp.

*The Handset beeps and the Time and Day Stamp is announced, followed by the total number of messages stored in memory. The **TALK/BATT LOW** LED lights orange.*



2. Press **■** to replay the current Time and Day Stamp while using the remote keys .

*The Handset beeps and the Time and Day Stamp is replayed, followed by the remaining recording time available for new messages.*

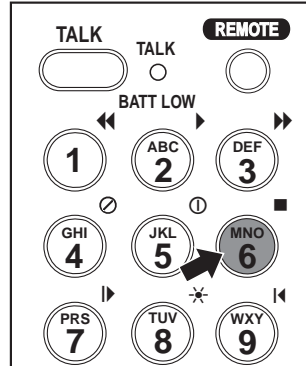

3. Press **REMOTE** again to return to Standby.



## Base Operation

1. Press **STOP**.

*The speaker beeps, and the Time and Day Stamp is announced followed by the remaining recording time available.*

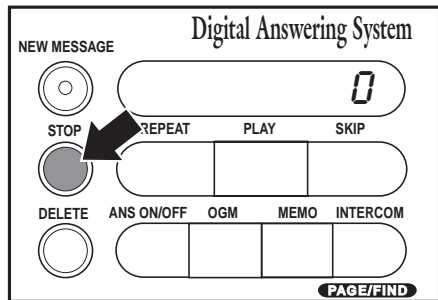

## Setting Your Outgoing Message (OGM)

When you receive a call, the Answering System answers and automatically plays either a preset message or your personal **OGM**.

### Preset Messages

The **XCA4500** has two messages programmed in its memory. If the **REC TIME/ANN-1** switch is in the right position, the first preset message below plays, and all incoming messages are limited to one minute. If the switch is set in the left position, (i.e., the "Announce Only" position) the second message below plays, and no incoming messages are recorded.

- *Hello. No one is available to take your call. Please leave your message after the tone.*
- *Hello. No one is available to take your call.*

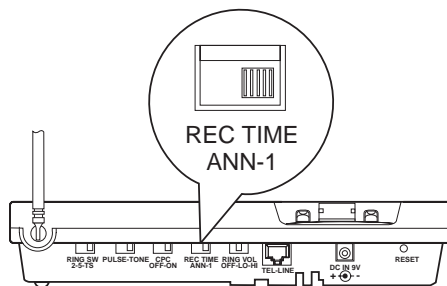

**Note:** *If the **REC TIME/ANN-1** switch is in the "Announce Only" position, the Message Counter LED displays an R when the system is in Standby.*

## Recording Your Personal OGM

### Handset Operation

1. Press **REMOTE** .

*The TALK/BATT LOW LED lights orange.*

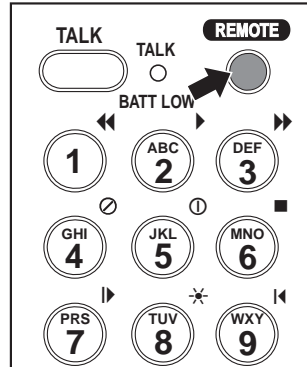

2. Press **7** .

**Note:** You can leave up to a 60-second outgoing message.

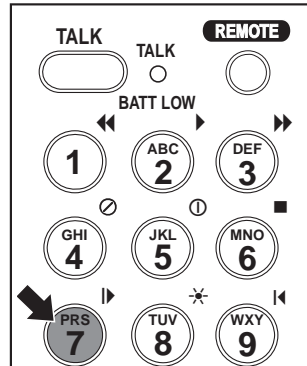

3. Press ■ to stop recording.

*The message replays in the Handset receiver.*

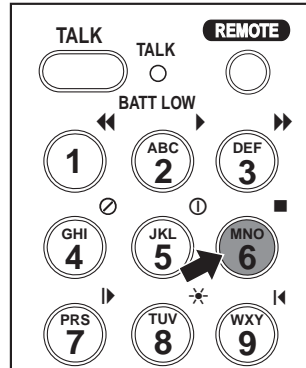

4. Press **REMOTE** again to return to Standby.

*The TALK/BATT LOW LED turns off.*

## Base Operation

1. To record an outgoing message, press and hold the **OGM** Button.

Start recording your message after you hear the long tone and the Message Counter LED begins to count up.

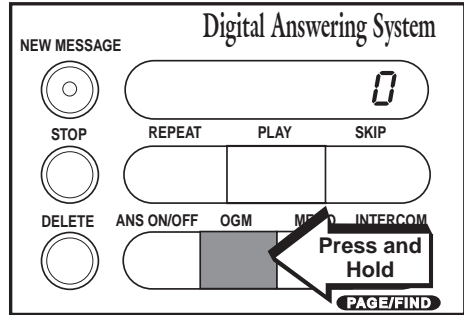

2. Do not get closer than 12 inches from the microphone, and speak clearly while recording your message. When you are finished recording, release the **OGM** Button.

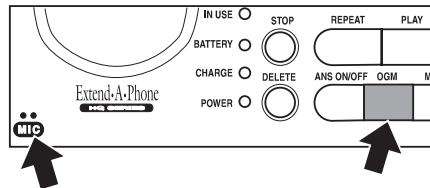

*You hear a tone, and your message is played on the Base Unit speaker. The Message Counter LED resets to zero.*

**Note:** You can leave up to a 60-second outgoing message.

## Selecting a Preset OGM

After you have recorded an outgoing message, you can set your Answering System to play either a preset message or your outgoing message.

1. Press **OGM**.

*Your recorded outgoing message will begin to play.*

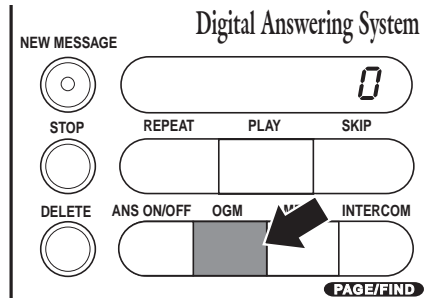

2. While your recorded outgoing message is playing, press **OGM** again.

*A tone will sound, and you hear the preset message "Hello. No one is available to take your call, please leave your message after the tone" on the Base Unit speaker. A second tone sounds after the preset message plays, and the Answering System automatically returns to Standby.*

**Note:** If the **REC TIME/ANN-1** switch is set to Announce Only, then the preset message "Hello. No one is available to take your call" is played.

3. To select your recorded message again, press **OGM**.

*The preset message will begin to play on the Base Unit speaker.*

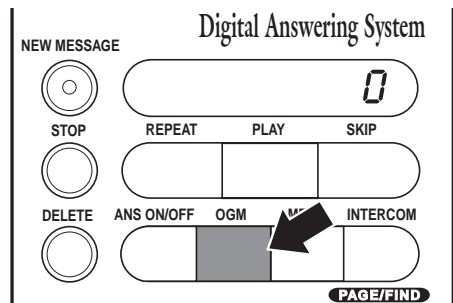

4. While the preset message is playing, press **OGM** again.

*A tone will sound, and your recorded message will play on the Base Unit speaker. A second tone sounds after your message plays, and the Answering System automatically returns to Standby.*

## Setting the Calling Party Control Switch

The Calling Party Control (**CPC**) switch sets your Answering System to disconnect and reset if the caller hangs up before leaving a message. This prevents your Answering System from using recording time to record a hang up/dial tone message.

**Note:** *It is possible that if someone calls while your outgoing message is playing or when a message is being recorded and you have Call Waiting, that the Answering System will disconnect and reset. To prevent this you can set the **CPC** switch to off.*

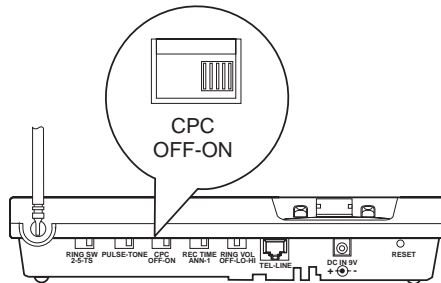

## Setting the Toll Saver Switch

The Ring Number/Toll Saver switch allows you to set the number of rings the caller hears before your Answering System answers. You can set the switch to answer after 2 rings or after 5 rings. In the **TS** (Toll Saver) position, the Answering System answers after two rings if you have messages recorded, and it answers after five rings if there are no messages. So if you call long distance to check your messages, you can hang up after the second ring and not be billed.

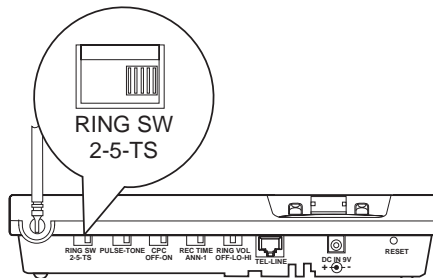

## Using the Reset Button

The **RESET** button is used to erase all recorded outgoing messages and any messages which are saved in memory. Pressing **RESET** does not erase your **PIN** (Personal Identification Number) code or the security code between the Handset and Base Unit.

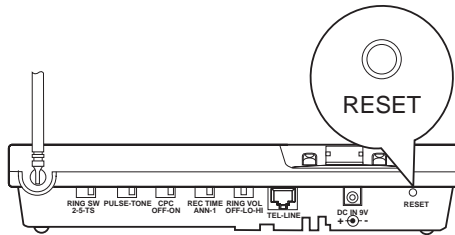

When **RESET** is pressed, the Message Counter begins to flash. See page 10, "Applying Power to the Base Unit," for instructions on returning the system to Standby.

**Note:** *The **RESET** button may also be used in the unlikely event that an AC power line disturbance causes the answering system to malfunction and become inoperative.*

---

---

# Using Your Answering System

---

---

## Playing New Messages

### Handset Operation

1. Press **REMOTE** .

*The current Time and Day Stamp and number of stored messages is announced.*

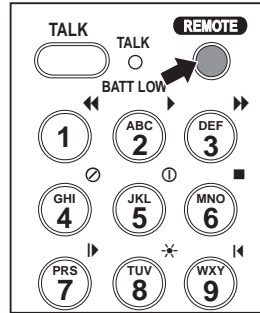

2. Press **\*-** .

*The time and day each message was received is announced before the message begins.*

**Note:** *If you want to stop reviewing your messages, press **■** .*

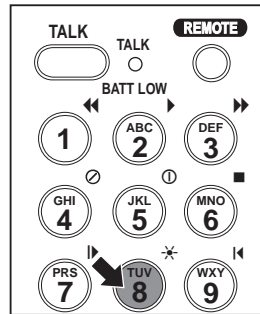

3. A tone sounds when each message ends. When all messages have played, the announcement "End of messages" plays.



4. Press **REMOTE** to return to Standby.

*The TALK/BATT LOW LED goes off.*

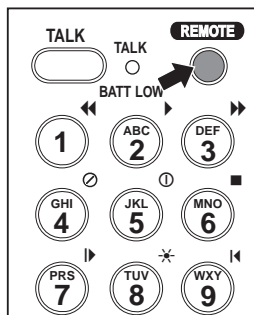

## Base Operation

1. Press **NEW MESSAGE**.

*The time and day each message was received is announced before the message begins, and the Message Counter LED displays the number of the message playing.*

**Note:** *If you want to stop reviewing your messages, press the **STOP** Button.*

2. A tone sounds when each message ends. When all messages have played, the announcement "End of messages" plays.

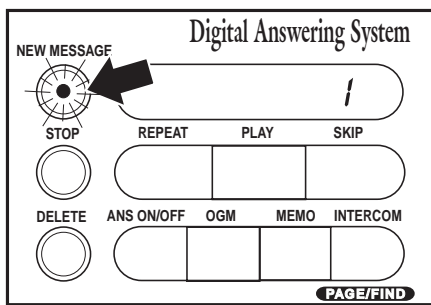

- After the end of message announcement another tone sounds, indicating the system has automatically returned to Standby.

*The **NEW MESSAGE** LED stops flashing, indicating that all of the new messages have been reviewed and stored.*

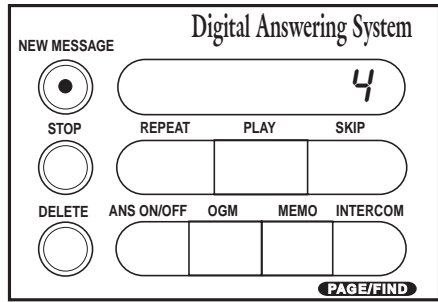

## Playing a Stored Message

### Handset Operation

- Press **REMOTE**.

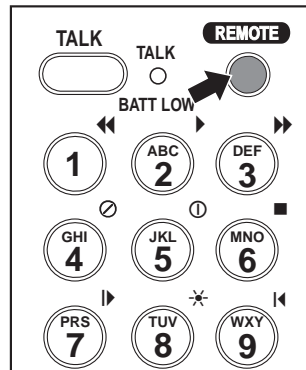

- Press **▶**.

*The first message stored begins playing.*

*The time and day each message was received is announced before the message begins.*

**Note:** *If you want to stop reviewing your messages, press **■**.*

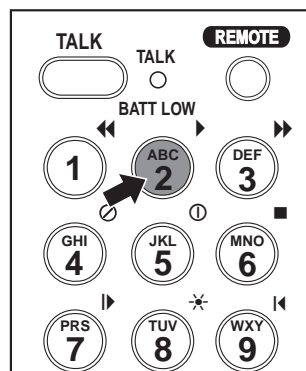

- A tone sounds when each message ends. When all messages have played, the announcement "End of messages" plays.
- Press **REMOTE** to return to Standby.

*The TALK/BATT LOW LED goes off.*



## Base Operation

- Press **PLAY**.

*The first message stored begins playing.*

*The time and day each message was received is announced before the message begins. The Message Counter LED displays the number of the message playing.*

**Note:** *If you want to stop reviewing your messages, press the **STOP** Button.*

- A tone sounds when each message ends. When all messages have played, the announcement "End of messages" plays.

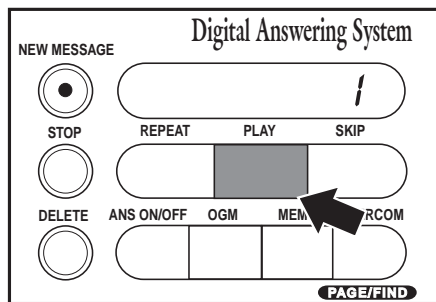

- After the end of message announcement another tone sounds, indicating the system has automatically returned to Standby.

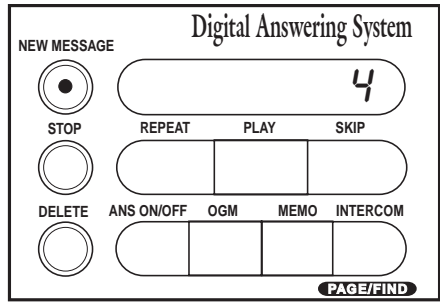

## Repeating a Message

### Handset Operation

- Press **REMOTE**.

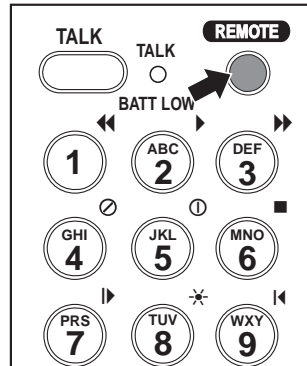

- Press **▶** to review your messages.

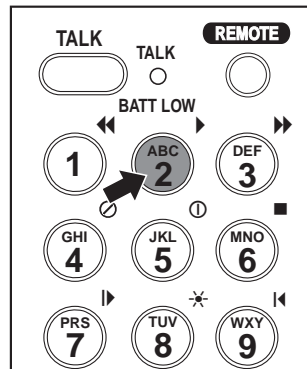

3. Press ◀◀ at anytime to replay a message.

**Note:** Pressing ◀◀ during a message returns the system to the beginning of that message. Pressing ◀◀ again before the message replays causes the system to scan back one message. If you have several messages, press ◀◀ until you return to the message you want to replay.



4. To return to Standby, press **REMOTE**.

The **TALK/BATT LOW LED** goes off.

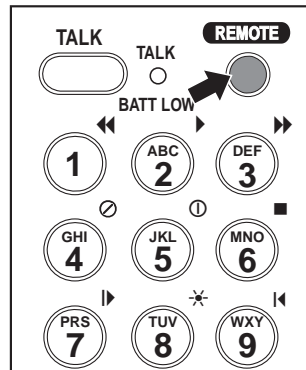

## Base Operation

1. Press **PLAY** to review your messages.

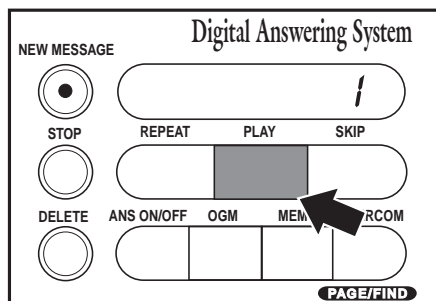

2. Press **REPEAT** at any time to replay a message.

**Note:** Pressing **REPEAT** during a message returns the system to the beginning of that message. Pressing **REPEAT** again before the message replays causes the system to scan back one message. If you have several messages, press **REPEAT** until you return to the message you want to replay.

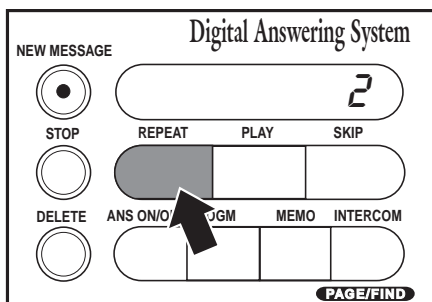

3. Press **STOP** at any time to stop reviewing messages and return to Standby.

The **NEW MESSAGE LED** remains on, and the Message Counter LED shows the total number of messages.

**Note:** The system will automatically return to Standby if all the messages play.

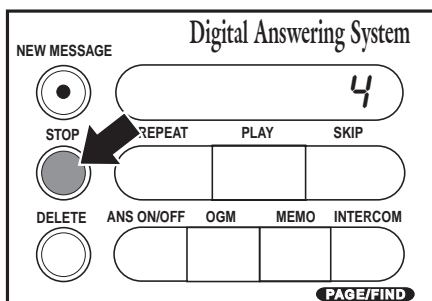

## Skipping a Message

### Handset Operation

1. Press **REMOTE**.

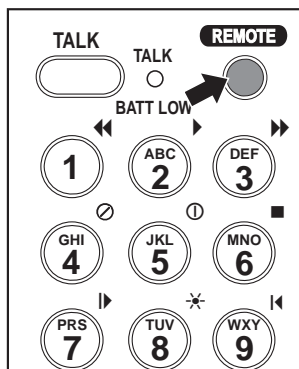

2. Press **▶** to review your messages.

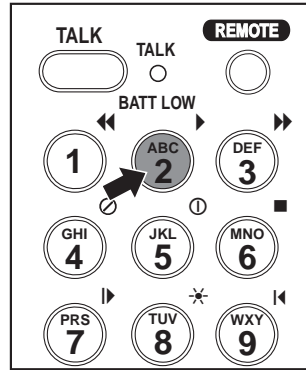

3. Press **▶▶** at any time to skip to the next message.

**Note:** Each time **▶▶** is pressed the system scans forward one message. If you have several messages, press **▶▶** until you get to the message you want to play.

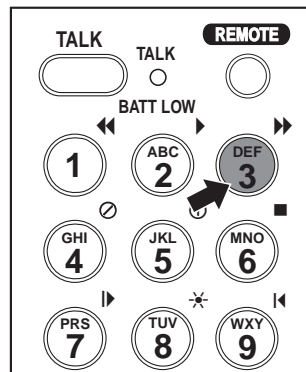

4. To return to Standby, press **REMOTE**.

The **TALK/BATT LOW LED** goes off.

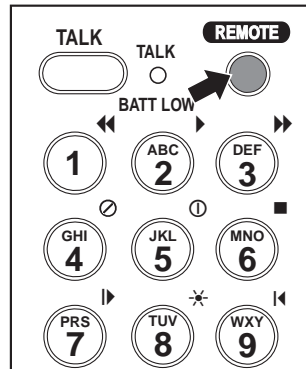

## Base Operation

1. Press **PLAY** to review your messages.

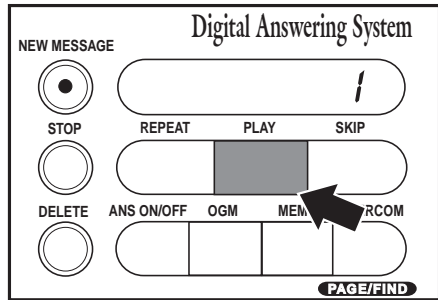

2. Press **SKIP** at any time to skip to the next message.

**Note:** Each time **SKIP** is pressed, the system scans forward one message. If you have several messages, press **SKIP** until you get to the message you want to play.

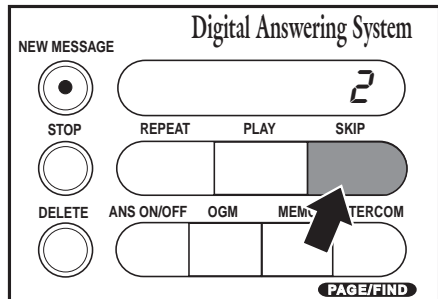

3. Press **STOP** at any time to stop reviewing messages and return to Standby.

The **NEW MESSAGE LED** remains on, and the Message Counter LED shows the total number of messages.

**Note:** The system automatically returns to Standby when all messages play.

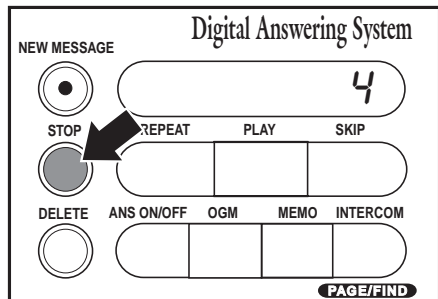



# Deleting a Message

## Handset Operation

1. Press **REMOTE** .



2. Press **▶** to review your messages.

**Note:** You can press the **✱** Key when you have received new messages.

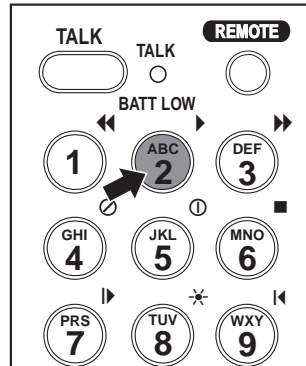

3. If you decide to delete a message, press **⊘** any time during the message.

The system beeps and immediately goes to the next message.

**Note:** When you press **⊘** you are tagging the message. A message must be tagged before it can be deleted.

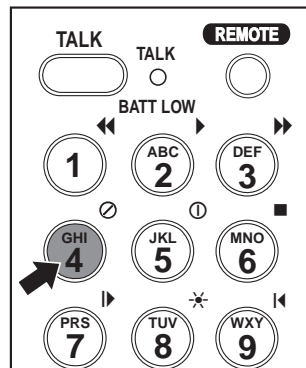

- If you tag a message for deletion and replay the message *again* before the *end-of-message* announcement, then the message is untagged and will not be deleted.

For example, you have received four messages and you tagged the second message for deletion. During the fourth message you press ◀◀ three times and replay message 2. If you don't tag message 2 for deletion again before the "End-of-messages" announcement, it will not be deleted.

**Note:** If you press ▶▶ and scan to a tagged message, and then let the message play, you must retag the message or it will not be deleted.

- When the "End of messages" announcement plays, you will hear a series of quick warning tones for five seconds in the Handset. This is followed by a long tone.

Then an announcement such as "Two messages deleted" plays.

**Note:** The deletion announcement above depends on how many messages you tag for deletion.

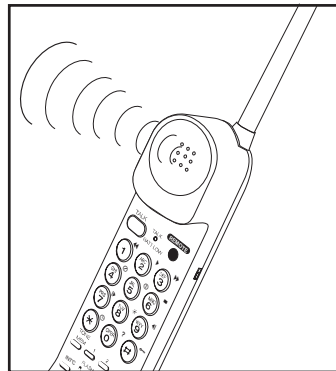
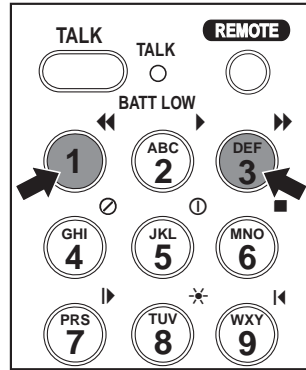

- The warning tones allow you to cancel the delete function and save your messages.

Pressing **▶** cancels the delete function and the messages begin replaying from the beginning.

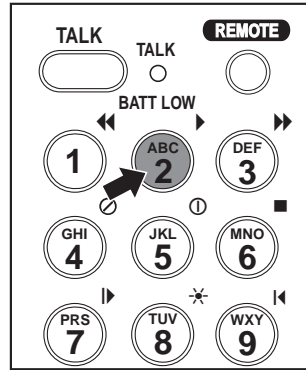

Pressing either **▶▶** or **◀◀** cancels the delete function. The messages are saved, and you can either select another menu command from the Handset or press **REMOTE** and return to Standby.

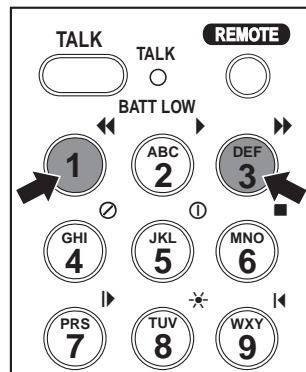

## Base Operation

- Press **PLAY** to review your messages.

**Note:** You can press the **NEW MESSAGE** Button when you have received new messages.

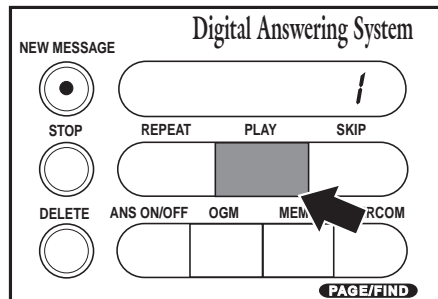

- If you decide to delete a message, press and release **DELETE** any time during the message.

*The system beeps and immediately goes to the next message.*

**Note:** When you press **DELETE** you are tagging the message. A message must be tagged before it can be deleted.

- If you tag a message for deletion and replay the message *again* before the "End-of-message" announcement, then the message is untagged and will not be deleted.

For example, you have received four messages and you tagged the second message for deletion. During the fourth message you press **REPEAT** three times and replay message 2. If you don't tag message 2 for deletion again before the "End-of-message" announcement, it will not be deleted.

**Note:** If you use the **SKIP** Button to scan to a tagged message and then let the message play, you must retag the message or it will not be deleted.

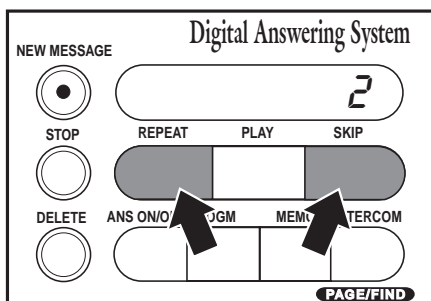
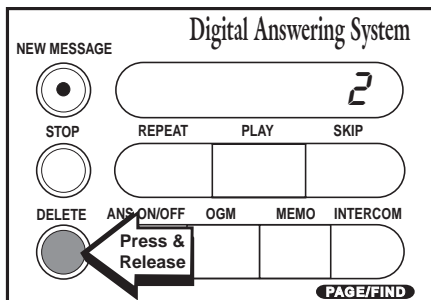

- When the “End of messages” announcement plays, you will hear a tone and the Message Counter LED will begin to flash a delete warning. A long tone sounds after five seconds on the Base speaker.

Then an announcement such as “Two messages deleted” plays.

**Note:** The deletion announcement above depends on how many messages you tag for deletion.

- The flashing delete warning displayed by the Message Counter LED allows you to cancel the delete function and save your messages.

Pressing **PLAY** cancels the delete function, and the messages begin replaying from the beginning.

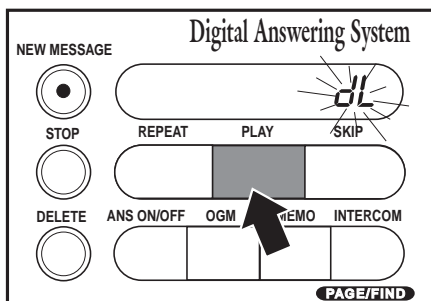
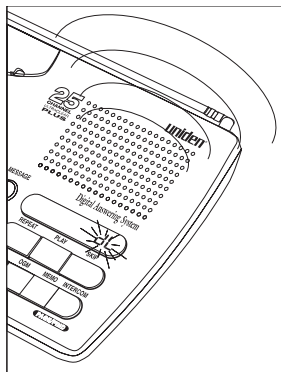

Pressing either **REPEAT** or **SKIP** cancels the delete function, and the messages are saved.

**Note:** If you reviewed all the messages, **NEW MESSAGE LED** will light but will not flash.

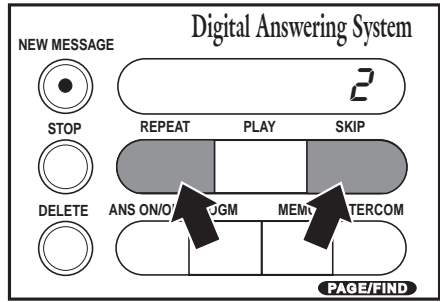

## Deleting All Messages

You can delete all your messages without tagging each separate message. To delete all the messages, you must use the **DELETE** button on the Base Unit.

1. Press and hold **DELETE**.

**Note:** You must review all messages before using the "Delete All Messages" function.

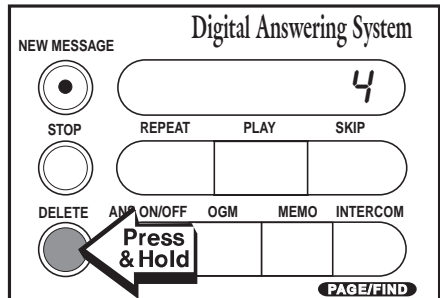

2. You will hear three short tones, followed by a longer tone.

And "**dL**" begins to flash in the Message Counter LED.

**Note:** You have five seconds to cancel delete before all of the messages are erased.

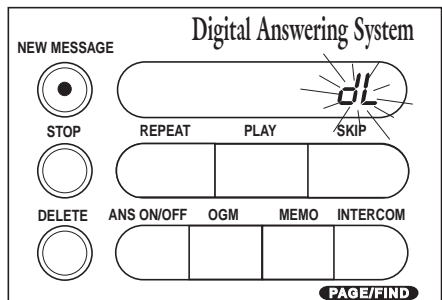

3. A long tone sounds, and then an announcement such as *"Four messages deleted"* plays.

**Note:** The deletion announcement above depends on how many messages are stored in memory.

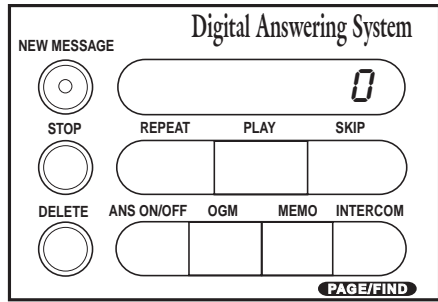

## Message Full Indication

The **XCA4500** has a maximum record time of 13 minutes and 42 seconds or up to 40 incoming messages. When the memory is full, the Answering System will not record incoming calls. To return the system to normal operation, follow these steps.

1. When the memory is full, the phone will ring 10 times before the announcement *"No remaining time for incoming messages"* plays.
2. The Message Counter LED on the Base Unit displays the **FL** warning.

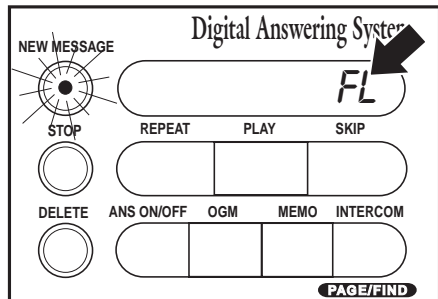

3. You must review your messages and then delete some or all of the stored messages.

## Voice-Guided Help Menu

If you are unsure of the commands available while using the Handset, you can use the Voice-Guided Help Menu. The Handset commands are reviewed for you on the Handset Receiver. To access the Help Menu, follow these steps.

1. Press **REMOTE** .

*The TALK/BATT LOW LED lights orange.*

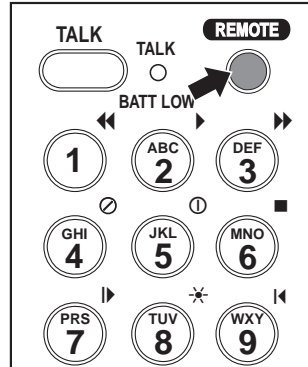

2. Press **?** .

*A tone sounds, and the Voice-Guided Menu begins to play.*

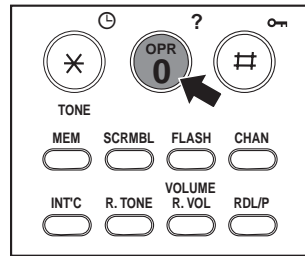

3. There are two ways to exit the Help Menu—press **■** any time during the review or listen to all the options and wait for the system to automatically exit.

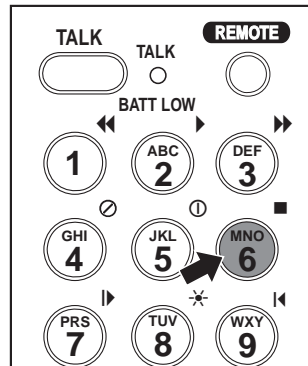



- When you exit Help, you will hear a short tone every three seconds, indicating that the system is in the *Command Waiting Mode*. Press another command, or press **REMOTE**, to return to Standby.

**Note:** You have 20 seconds to enter another command while in the *Command Waiting Mode* before the system automatically returns to Standby.

When you return to Standby, the **TALK/BATT LOW LED** goes off.

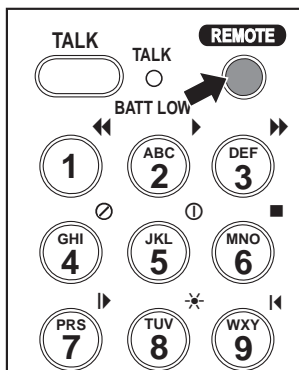

## Screening Incoming Calls

If you receive a call while your Answering System is on, you can listen to the **OGM** announcement and the incoming message on the Base Unit speaker. If you are away from the Base, you can use your Handset to screen incoming calls.

- Press **REMOTE** after the phone begins to ring.

The **TALK/BATT LOW LED** lights orange.

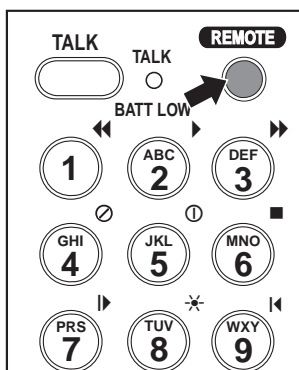

- You can now listen to the **OGM** and incoming message on the Handset receiver. If you decide to answer the call, press **TALK** .

**Note:** The Answering System stops recording the incoming message when **TALK** is pressed.

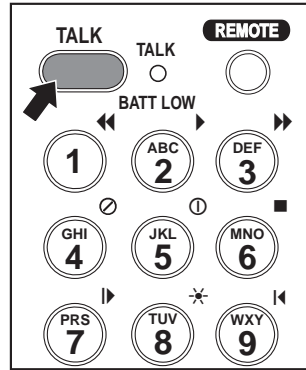

- When you finish the call, press **TALK** to hang up.

The **TALK/BATT LOW LED** goes off.

## Leaving a Memo Message

You can use the **XCA4500A** to leave a Memo Message for someone else who uses your Answering System.

- To record your Memo Message, press and hold the **MEMO** Button until you hear a long tone and the Message Counter LED begins to count up.

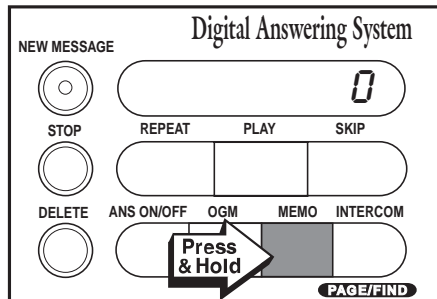

2. Speak into the microphone. When you are finished recording, release the **MEMO** Button.

*There is a tone, and the **NEW MESSAGE** LED begins to flash. The Message Counter LED shows the total number of messages stored in memory.*

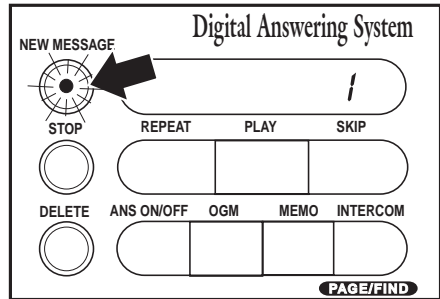

3. After you have recorded your message, the system returns to Standby.

**Note:** *If you have new or unplayed messages, the **NEW MESSAGE** LED on the Base Unit continues to flash. If all the messages have been reviewed, the **NEW MESSAGE** LED remains on but doesn't flash.*

## Recording a Telephone Conversation

To record a conversation during a call:

1. Press **REMOTE** .

*The **TALK/BATT LOW LED** changes from red to orange, and the telephone sounds warning beeps to let the other party know that the call is being recorded.*



2. To stop recording, press **REMOTE** again.

*The **TALK/BATT LOW LED** changes from orange back to red.*

**Note:** *A recorded call is like a message—if you use all of the available record time, the Recording function cancels automatically.*

---

---

## Remote Operation

---

---

You can operate your **XCA4500** while you're away from home by calling from any touch-tone phone. When using this feature, remember these important guidelines.

- You should change your Personal Identification Number (**PIN**) before using your Handset. When you first apply power, the code is set to 00.
- The dialing keys on a touch-tone phone work the same as the function keys on your phone's Handset except you must press # before selecting a command.
- You cannot change the Time and Day Stamp or your **PIN** code from a touch-tone phone.

### Setting Your PIN Code

Using the Handset, you can set a personal two-digit code (00 to 99) for your **PIN** code. You must use your **PIN** code to access your Answering System from a touch-tone telephone.

1. Press **REMOTE** .

*The TALK/BATT LOW LED lights orange.*



2. Press **☎**

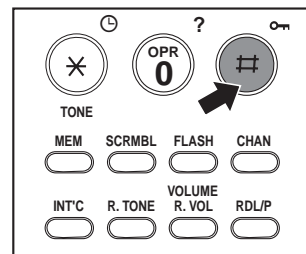

3. Press your two-digit code.

② ②

For example, use **22** as the new **PIN** number.

4. Press  again.

*You will hear a long tone which indicates that the new code is saved.*

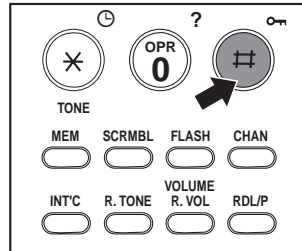

5. Press **REMOTE** again to return to Standby.

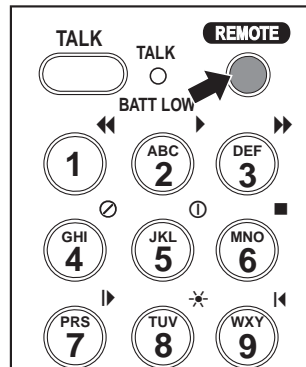

## Using a Touch-Tone Phone

You can operate your Answering System using any touch-tone telephone. Use this function to check for recorded messages, play or delete messages, or even record a new outgoing message.

1. Call your telephone number.
2. During the **OGM** playback, press **(\*)** followed by your **PIN** number.

For example, use **(3)(3)** as the new **PIN** number.



3. The Answering System announces the Time and Day Stamp followed by the number of messages stored in memory. When messages are stored in memory, the system automatically begins playing them now.
4. You then hear intermittent beeps indicating that the system is in the Command Waiting Mode.

**Note:** You must enter a command within 20 seconds or the Answering System hangs up and returns to Standby.

5. Use this chart to select the function you want.

<b>Function</b>	<b>Press</b>
Repeat	#1
Play	#2
Skip	#3
Delete Message	#4
Answer On/Off	#5
Stop	#6
Record OGM	#7
Play New Message	#8
Replay OGM	#9
Help Menu	#0

6. When you've finished, hang up to exit the system.

*Your Answering System automatically returns to Standby.*



## Troubleshooting

If your **XCA4500A** Integrated Telephone Answering Device is not performing to your expectations, please try these simple steps. If you are still unable to resolve the problems, contact Uniden Customer Service at (800) 297-1023, 8:00 a.m. to 5:00 p.m. Central, Monday through Friday.

### Telephone Troubleshooting Chart

Problem	Suggestion
Charge light won't come on when Handset is placed in Base Unit.	<ul style="list-style-type: none"> <li>• Make sure AC Adapter is plugged into the Base Unit and wall outlet.</li> <li>• Make sure Handset is properly seated in Base Unit.</li> <li>• Make sure that the charging contacts on the Handset and Base Unit are clean.</li> </ul>
Audio sounds weak and/or scratchy.	<ul style="list-style-type: none"> <li>• Make sure that the Base Unit antenna is fully extended and vertical.</li> <li>• Move the Handset and/or Base Unit to different locations and try again.</li> <li>• Press the <b>CHAN</b> Button to select another channel.</li> </ul>
Can't make or receive calls.	<ul style="list-style-type: none"> <li>• Check both ends of the Base Unit telephone line cord.</li> <li>• Make sure the AC Adapter is plugged into the Base Unit and wall outlet.</li> <li>• Disconnect the AC Adapter for a few minutes, and then reconnect it.</li> </ul>
Handset doesn't ring or receive a page.	<ul style="list-style-type: none"> <li>• Nickel-Cadmium battery pack may be weak. Charge the battery on the Base Unit for 15–20 hours.</li> <li>• Set the <b>RING ON/BATT SAVE</b> switch on the Handset to <b>RING ON</b>.</li> <li>• Extend the Base Unit antenna vertically.</li> <li>• The Handset may be too far away from the Base Unit.</li> <li>• Place the Base Unit away from noise sources.</li> <li>• The Digital Security Code may be erased. Set the Digital Code.</li> </ul>
Base Unit doesn't ring or receive a page.	<ul style="list-style-type: none"> <li>• Set the Base Unit Ringer switch to <b>LO</b> or <b>HI</b>.</li> </ul>

## Answering System Troubleshooting Chart

Problem	Suggestion
Answering System does not work.	<ul style="list-style-type: none"> <li>• Make sure that the Base Unit is plugged in.</li> <li>• Make sure the Answering System is turned on.</li> <li>• Press the <b>RESET</b> button to reset the system after an AC line spike.</li> </ul>
Answering System does not answer calls.	<ul style="list-style-type: none"> <li>• Set the <b>REC TIME/ANN-1</b> switch in the right-hand position.</li> <li>• The memory may be full. Delete some or all of the saved messages.</li> </ul>
Messages are incomplete.	<ul style="list-style-type: none"> <li>• The incoming messages may be too long. Remind callers to leave a brief message.</li> <li>• If you have Call Waiting, set the <b>CPC</b> switch to <b>OFF</b>.</li> <li>• The memory may be full. Delete some or all of the saved messages.</li> </ul>
After a power failure, the <b>OGM</b> is deleted.	<ul style="list-style-type: none"> <li>• Check the battery backup, and replace the battery if necessary.</li> </ul>
Message Counter LED flashes the letter <b>P</b> .	<ul style="list-style-type: none"> <li>• There has been a power failure and the battery backup has been completely discharged. Replace the battery, and press <b>STOP</b> to reset the Answering System.</li> </ul>
The <b>BATTERY</b> LED on the Base Unit flashes.	<ul style="list-style-type: none"> <li>• Replace the backup battery as soon as possible.</li> </ul>
No sound on the Base Unit speaker during call monitoring or message playback.	<ul style="list-style-type: none"> <li>• Adjust the volume control on the side of the Base Unit.</li> </ul>
The Handset Receiver volume is not loud enough.	<ul style="list-style-type: none"> <li>• Press the <b>VOLUME/R. VOL</b> key when using the Handset to adjust the volume.</li> </ul>
Cannot access remote call-in features from another touch-tone phone.	<ul style="list-style-type: none"> <li>• Make sure you're using the correct <b>PIN</b> number.</li> <li>• Make sure that the touch-tone phone you're using can transmit the tone for at least two seconds. If it cannot, you may have to change to another phone.</li> </ul>

---

---

## Specifications

---

---

**General** – The XCA4500A complies with FCC Rules, Parts 15 and 68.

Frequency Control	Phase Locked Loop (PLL) Synthesizer
Modulation	FM
Operating Temperature	- 10° to 50° C

### Base Unit

Receive Frequency	48.76 to 49.99 MHz (25 Channels)
Transmit Frequency	43.72 to 46.97 MHz (25 Channels)
Power Requirements	120V AC 60 Hz
Size	8 $\frac{3}{8}$ in. (W) x 5 $\frac{17}{32}$ in. (D) x 1 $\frac{7}{8}$ in. (H)
Weight	Approx. 18.9 oz.

### Handset

Receive Frequency	43.72 to 46.97 MHz (25 Channels)
Transmit Frequency	48.76 to 49.99 MHz (25 Channels)
Power Requirements	Rechargeable Ni-Cd Battery Pack
Size	2 $\frac{3}{16}$ in. (W) x 2 $\frac{11}{16}$ in. (D) x 12 $\frac{3}{32}$ in. (H) (w/ antenna)
Weight	Approx. 10 oz. (including battery)
Battery	BT-185
Capacity	270 mAh, 3.6V
Talk Mode	6 hours
Standby Mode	7 days
Battery Save Mode	5 weeks

### Answering System

Memory Type	Digital Tapeless Recording
Memory Capacity	13 min., 42 sec. (40 messages)
Message Length	1 min. Incoming Message (max.) 1 min. <b>OGM</b> (max.)

*Specifications, Features, and availability of Optional Accessories are all subject to change without prior notice.*

# uniden®

## ***XCA4500*** ***Integrated Telephone*** ***Answering Device***



UDZZ01355ZZ

Download from [www.Somanuals.com](http://www.Somanuals.com). All Manuals Search And Download.

## ***Operating Guide***

# PRECAUTIONS

Before you read anything else,  
please observe the following:

---

## WARNING!

Uniden America Corporation **DOES NOT** represent this unit to be waterproof. To reduce the risk of fire, electrical shock, or damage to the unit, **DO NOT** expose this unit to rain or moisture.

---

### RECHARGEABLE NICKEL-CADMIUM BATTERY WARNING

- This equipment contains a Rechargeable Nickel-Cadmium Battery.
- Cadmium is a chemical known to the State of California to cause cancer.
- The Rechargeable Nickel-Cadmium Battery contained in this equipment may explode if disposed of in a fire.
- **Do not** short-circuit the battery.
- **Do not** charge the Rechargeable Nickel-Cadmium Battery used in this equipment in any charger other than the one designed to charge this battery as specified in this Guide. Using another charger may damage the battery or cause the battery to explode.

### RECHARGEABLE NICKEL-CADMIUM BATTERIES MUST BE RECYCLED OR DISPOSED OF PROPERLY

- Residents of Minnesota should contact 1-800-225-PRBA for information concerning reclamation and disposal of Rechargeable Nickel-Cadmium batteries.
- Residents outside of Minnesota should contact their local authorities for information concerning reclamation and disposal of Rechargeable Nickel-Cadmium batteries.



The exclamation point within an equilateral triangle is intended to alert the user to the presence of important operating and maintenance (servicing) instructions in the literature accompanying the appliance.

# Answering Device Remote Keys

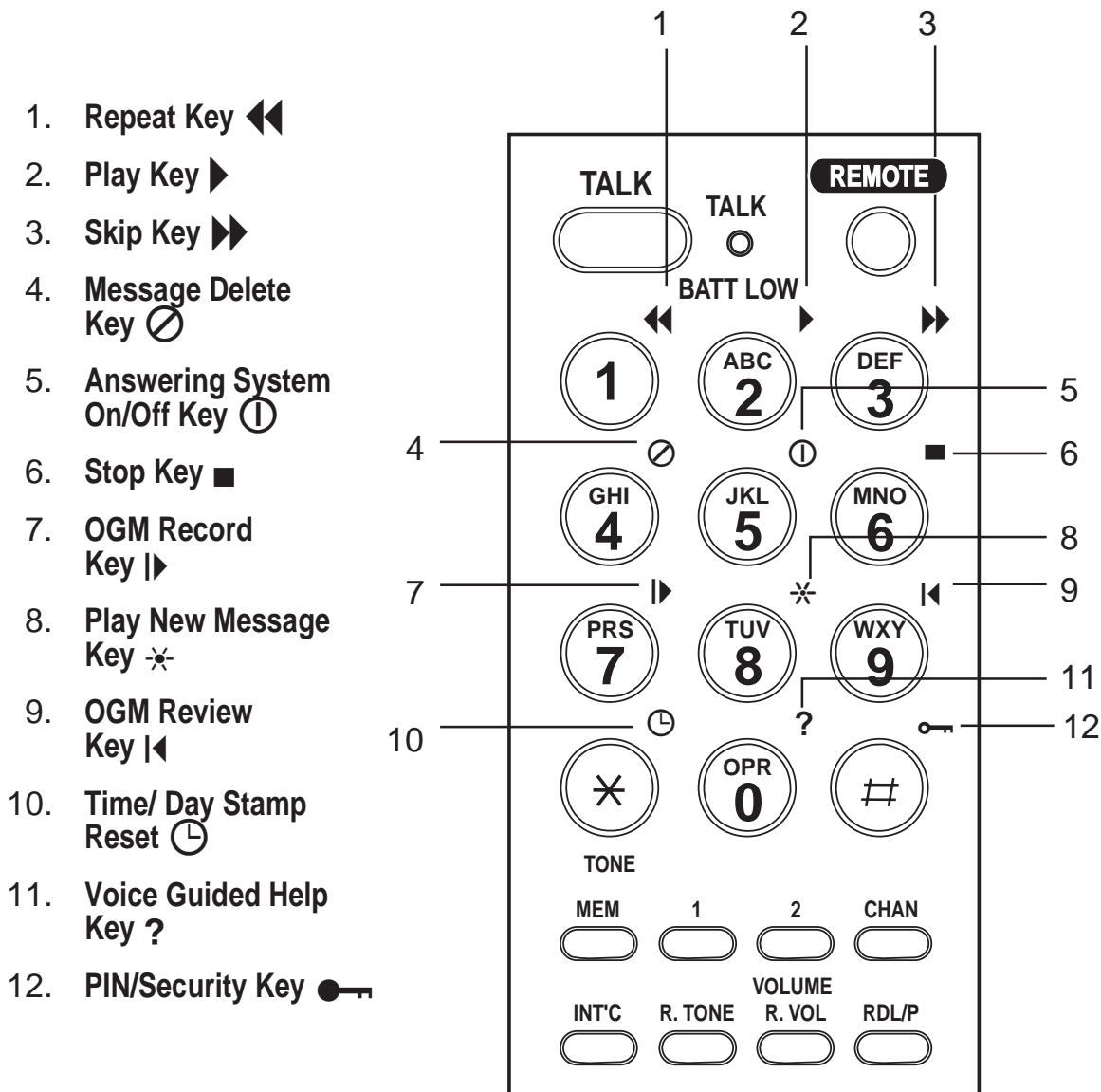

# Handset Controls and Keys

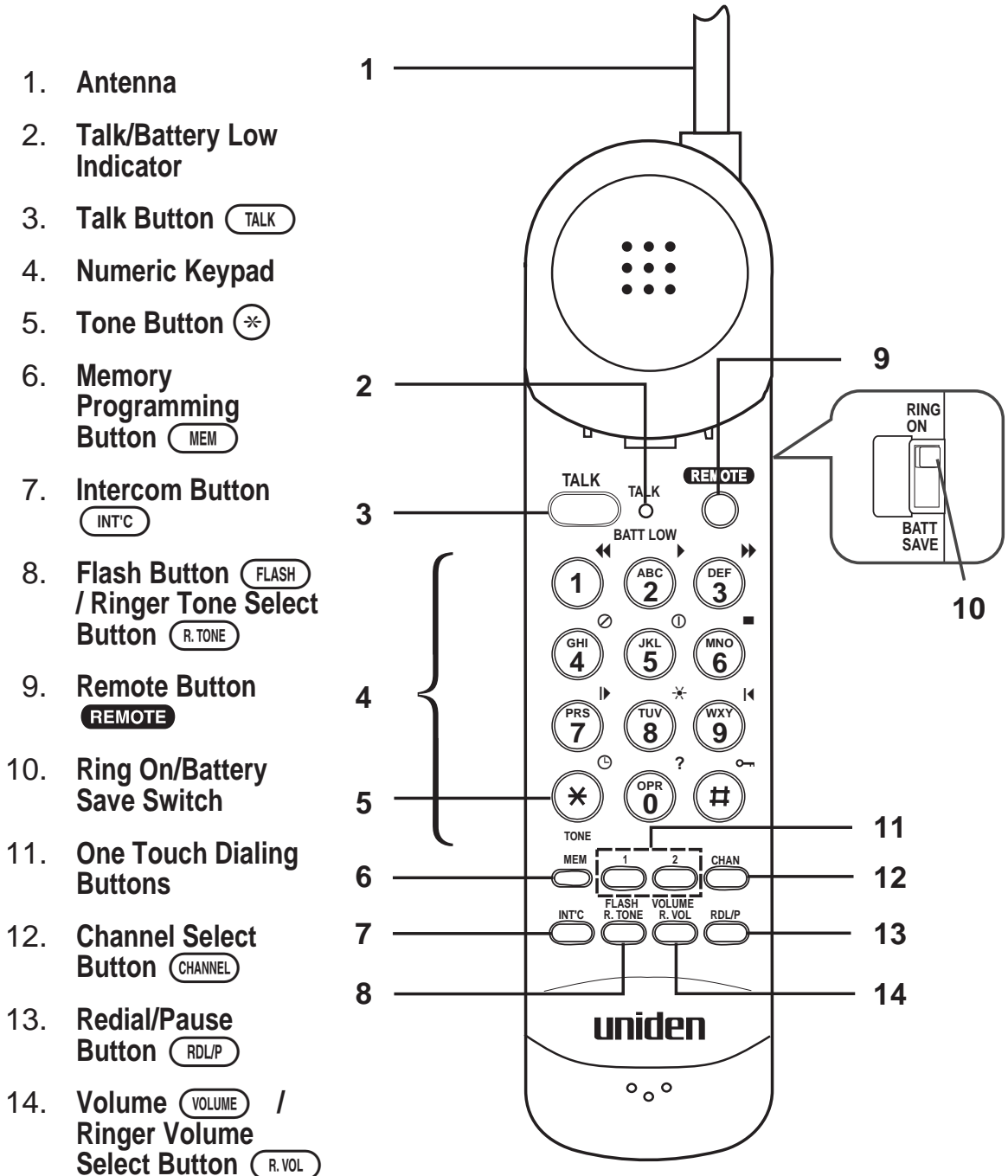

# Base Unit Controls and Keys

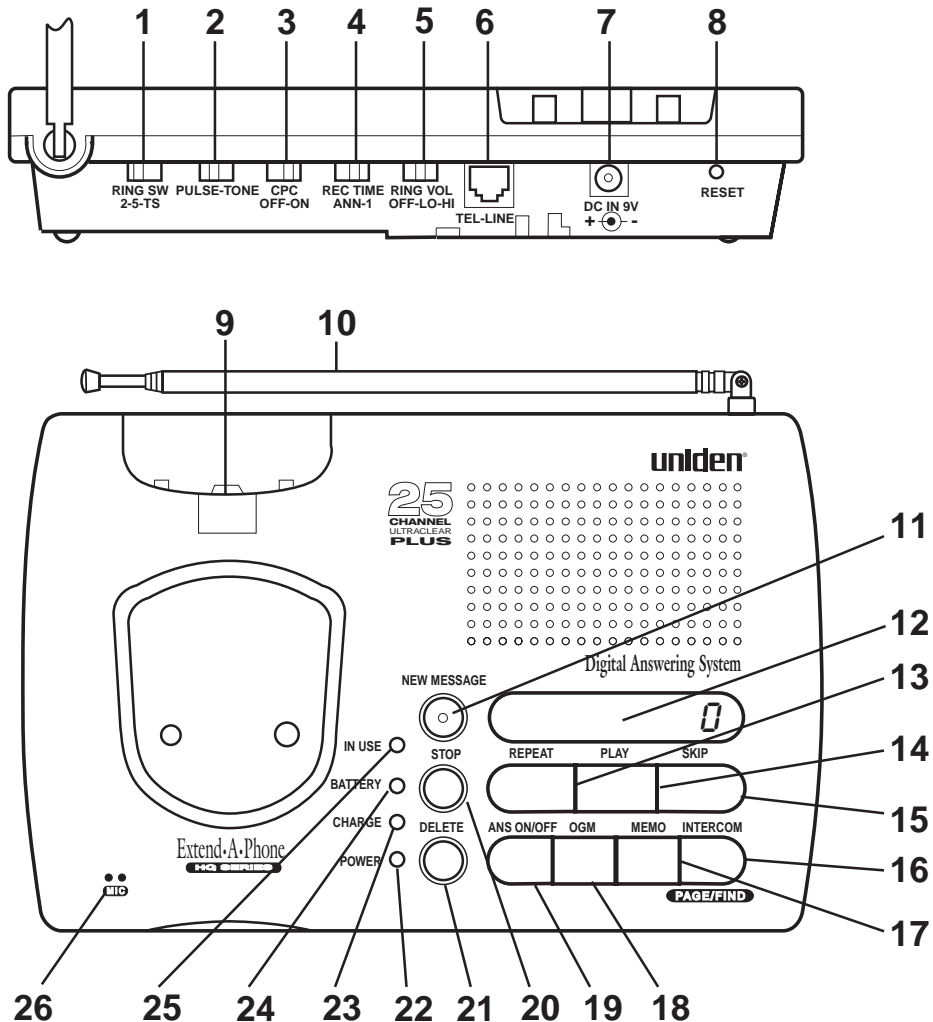

- |                                 |                                    |
|---------------------------------|------------------------------------|
| 1. Ring Switch (2-5-TS)         | 14. Message Play Button            |
| 2. Pulse/Tone Switch            | 15. Message Skip Button            |
| 3. Calling Party Control Switch | 16. Intercom Button                |
| 4. Record Time/Ann-1 Switch     | 17. Memo Button                    |
| 5. Ringer Volume Switch         | 18. Outgoing Message Button        |
| 6. Telephone Line Jack          | 19. Answering System On/Off Button |
| 7. DC Power Jack                | 20. Stop Button                    |
| 8. Reset Button                 | 21. Message Delete Button          |
| 9. Handset Retainer             | 22. Power LED                      |
| 10. Base Unit Antenna           | 23. Charge LED                     |
| 11. New Message LED/Button      | 24. Battery LED                    |
| 12. Message Counter LED         | 25. In Use LED                     |
| 13. Message Repeat Button       | 26. Microphone                     |



---

---

## One Year Limited Warranty

---

---

**Important:** Evidence of original purchase is required for warranty service.

**WARRANTOR:** UNIDEN AMERICA CORPORATION (“Uniden”)

**ELEMENTS OF WARRANTY:** Uniden warrants, for one year, to the original retail owner, this Uniden Product to be free from defects in materials and craftsmanship with only the limitations or exclusions set out below.

**WARRANTY DURATION:** This warranty to the original user shall terminate and be of no further effect 12 months after the date of original retail sale. The warranty is invalid if the Product is (A) damaged or not maintained as reasonable or necessary, (B) modified, altered, or used as part of any conversion kits, subassemblies, or any configurations not sold by Uniden, (C) improperly installed, (D) serviced or repaired by someone other than an authorized Uniden service center for a defect or malfunction covered by this warranty, (E) used in any conjunction with equipment or parts or as part of any system not manufactured by Uniden, or (F) installed or programmed by anyone other than as detailed by the Operating Guide for this product.

**STATEMENT OF REMEDY:** In the event that the product does not conform to this warranty at any time while this warranty is in effect, warrantor will repair the defect and return it to you without charge for parts, service, or any other cost (except shipping and handling) incurred by warrantor or its representatives in connection with the performance of this warranty. THE LIMITED WARRANTY SET FORTH ABOVE IS THE SOLE AND ENTIRE WARRANTY PERTAINING TO THE PRODUCT AND IS IN LIEU OF AND EXCLUDES ALL OTHER WARRANTIES OF ANY NATURE WHATSOEVER, WHETHER EXPRESS, IMPLIED OR ARISING BY OPERATION OF LAW, INCLUDING, BUT NOT LIMITED TO ANY IMPLIED WARRANTIES OF MERCHANTABILITY OR FITNESS FOR A PARTICULAR PURPOSE. THIS WARRANTY DOES NOT COVER OR PROVIDE FOR THE REIMBURSEMENT OR PAYMENT OF INCIDENTAL OR CONSEQUENTIAL DAMAGES. Some states do not allow this exclusion or limitation of incidental or consequential damages so the above limitation or exclusion may not apply to you.

**LEGAL REMEDIES:** This warranty gives you specific legal rights, and you may also have other rights which vary from state to state. This warranty is void outside the United States of America.

**PROCEDURE FOR OBTAINING PERFORMANCE OF WARRANTY:** If, after following the instructions in this Operating Guide you are certain that the Product is defective, pack the Product carefully (preferably in its original packaging). Include evidence of original purchase and a note describing the defect that has caused you to return it. The Product should be shipped freight prepaid, by traceable means, or delivered, to warrantor at:

**Uniden America Corporation  
Parts and Service Division  
4700 Amon Carter Boulevard  
Fort Worth, TX 76155  
(800) 297-1023, 8:00 a.m. to 5:00 p.m. Central, Monday through  
Friday**

Covered under one or more of the following U.S. patents:

4,511,761

4,595,795

4,797,916

4,523,058

**uniden<sup>®</sup>**

©1995 Uniden America Corporation. All rights reserved.  
Printed in Hong Kong

## Free Manuals Download Website

<http://myh66.com>

<http://usermanuals.us>

<http://www.somanuals.com>

<http://www.4manuals.cc>

<http://www.manual-lib.com>

<http://www.404manual.com>

<http://www.luxmanual.com>

<http://aubethermostatmanual.com>

Golf course search by state

<http://golfingnear.com>

Email search by domain

<http://emailbydomain.com>

Auto manuals search

<http://auto.somanuals.com>

TV manuals search

<http://tv.somanuals.com>