



E X A I 8 9 8 5

OWNER'S MANUAL

900 MHz Cordless
Phone with Digital
Answering System

Caller ID and
Call Waiting
Operation

3-Way Conference
Operation

Uniden®

INTRODUCTION

TO YOUR NEW PHONE

Introduction

Thank you for choosing the Uniden EXAI 8985 cordless telephone. This phone is designed to exacting standards that provide reliability, long life and outstanding performance.

Note: Some illustrations in this manual may differ from the actual unit for explanation purposes.

Features

- 900 MHz Extended Range
- Secure Digital Transmission
- Answering Device
- 50 Number Caller ID Memory
- 30 Number Memory
- 32 Digit Redial
- 3-Line, 16 Character Backlit LCD Handset Display
- Redial, Flash and Pause
- Pulse / Tone Dialing
- 7 Hour Talk Time
- 7 Day Standby Battery Life
- Handset Earpiece and Ringer Volume Control
- Speakerphone
- 3-Way Conference Operation

Controls and functions

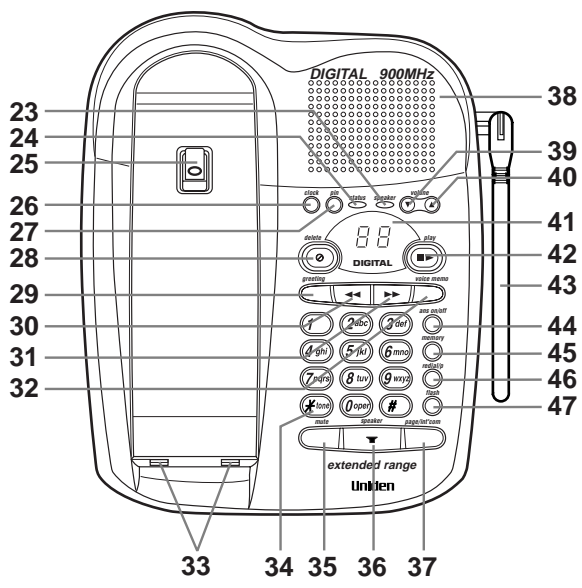
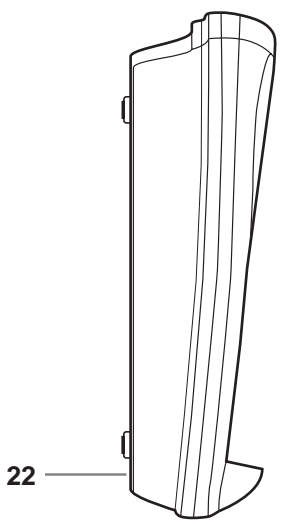
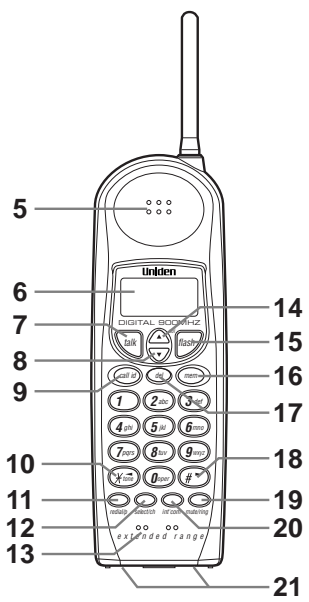
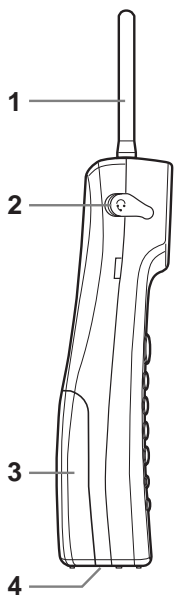

1. Handset antenna
2. Headset cover
3. Handset battery compartment
4. Handset ring switch
5. Handset speaker
6. LCD display
7. Talk key
8. Volume/Cursor down/
character select key
9. Caller ID key
10. Tone/Backspace key
11. Redial/Pause key
12. Select/Channel key
13. Handset microphone
14. Volume/Cursor up/
Character select key
15. Flash key
16. Memory key
17. Delete key
18. Cursor forward key
19. Mute/Ring key
20. Intercom key
21. Handset contact
22. Base microphone
23. Speaker LED
24. Status LED
25. Handset clip storage
26. Clock key
27. Pin code key
28. Delete key
29. Greeting key
30. Repeat key
31. Skip key
32. Voice memo record key
33. Base contact
34. Tone key
35. Mute key
36. Speaker key
37. Page/Intercom key
38. Base speaker
39. Volume down key
40. Volume up key
41. LED display
42. Play/Stop key
43. Base antenna
44. Answer on/off key
45. Memory key
46. Redial/Pause key
47. Flash key
48. Rec time switch
49. Ring time switch
50. Ring volume switch
51. Pulse-Tone switch
52. DC power input
53. Phone jack

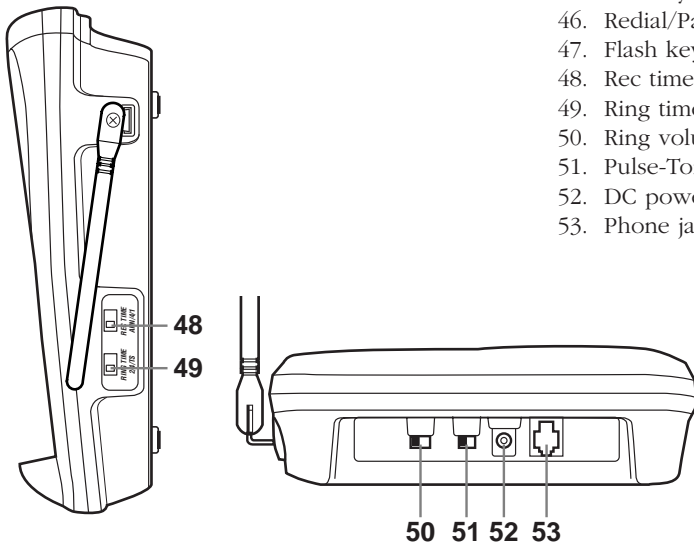

Contents

Introduction / Features.....	inside front cover
Controls and Functions	inside front cover
Getting Started	
Read this first.....	3
Step 1: Checking the package contents.....	4
Step 2: Setting up the base unit	5
Mounting the base unit on a wall	8
Step 3: Preparing the battery pack.....	10
Step 4: Setting the Caller ID options.....	12
Entering your area code.....	13
Basics	
Making a call	14
Receiving a call	15
Mute	16
Adjusting ringer and earpiece volume.....	17
Redialing a call.....	18
Using the speaker phone	20
Using your EXAI 8985 intercom.....	21
Transferring a call.....	22
Memory Dialing	
Storing phone numbers and names.....	23
Making calls with memory dialing.....	26
Editing a stored name and/or phone number...28	
Erasing a stored name and phone number.....	30
3-way Conference Feature	
3-way conferencing.....	32
Caller ID features	
Caller ID service	33
When the telephone rings.....	34
Viewing the Caller ID Message list.....	35
Deleting information from Caller ID list.....	36
Using the Caller ID list	38
Using "Caller ID with call waiting" service	40
The Integrated Answering Device	
Features.....	41
Setting up your answering system.....	42
Using your answering system	46
Additional Information	
Changing the digital security code.....	52
Installing the beltclip.....	53
Headset installation	53
Note on power sources	54
Maintenance.....	54
Troubleshooting	55
Specifications	57
Index	58

Getting Started

Basics

Memory Dialing

3-way
Conference
Features

Caller ID
Features

The Integrated
Answering
Device

Additional
Information

Read this first

This cordless telephone must be set up before use. Follow these steps;

Step 1 (page 4)

Unpack the telephone and accessories.

Step 2 (page 5 to 9)

Next, choose the best location to set up the base unit.



Base unit

Step 3 (page 10 to 11)

Then, insert the battery pack into the handset. You have to charge the battery pack for more than 12 hours before using the phone.



Handset

Step 4 (page 12 to 13)

Finally, set Caller ID options and store your area code in the memory to use the Caller ID service.



Handset

Note: Skip the setting of area code if your calling area requires 10 digit dialing.

About the digital security code

This cordless telephone uses a digital security code to prevent unauthorized access to your base unit. This security code prevents other cordless handsets from making calls through your base unit. A random security code will be assigned automatically between your base unit and handset when you charge the battery pack for the first time.

If you want to reset the security code, see page 52.

Checking the package contents

Make sure you have received the following items in the package. If any of these items are missing or damaged, contact the **Uniden Parts Department** (see below).



• Base unit



• Handset

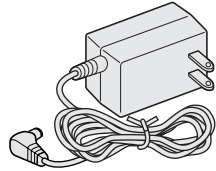

• AC adapter (AD-420)

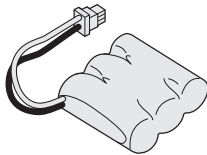

• Rechargeable battery pack (BT-905)

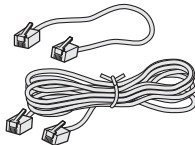

• Telephone line cord (2)

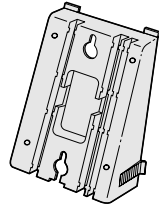

• Wall mount adapter

- This Owner's Manual
- Precautions and Important Safety Instructions
- Registration Card

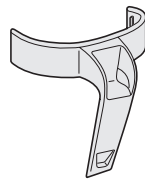

• Beltclip

Uniden Parts Department

(800) 554-3988

Hours: M-F 8:30 AM to 5:00 PM CST.

We can also be reached on the web at www.uniden.com.

Setting up the base unit

Do the following steps.

- Choose the best location
- Connect the base unit
- Choose the dialing mode

Choose the best location

Before choosing a location for your new phone, read the INSTALLATION CONSIDERATIONS included in the PRECAUTIONS AND IMPORTANT SAFETY INSTRUCTIONS brochure. Here are some important guidelines you should consider:

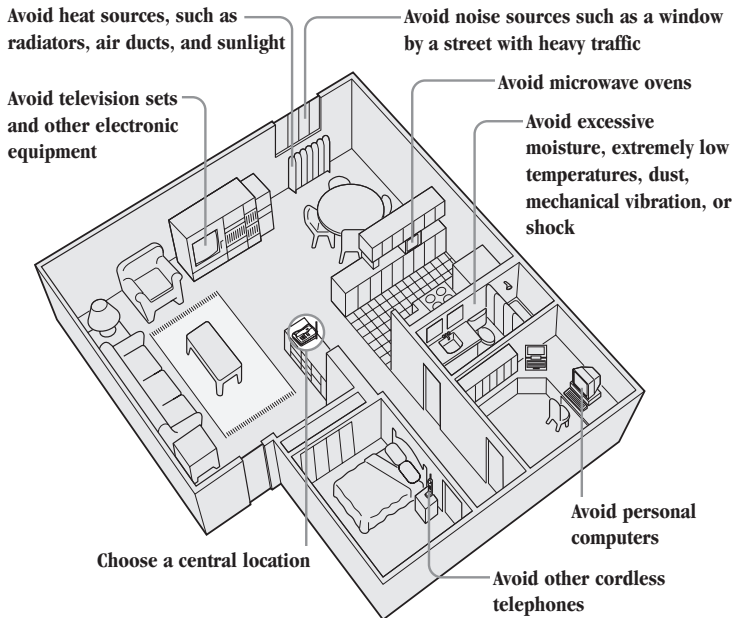

- You should charge your handset for 12-15 hours before using the phone.
- The location should be close to both a phone jack and a continuous power outlet which is not switchable.
- Keep the base and handset away from sources of electrical noise such as motors and fluorescent lighting.
- Be sure there is sufficient space to raise the base antenna fully vertical.
- The base can be placed on a desk, tabletop or mounted on a standard wall plate.

Connect the base unit

If you want to install the base unit on the wall, see page 8.

NOTE

Place the power cord so it does not create a trip hazard, or where it could become chafed and create a fire or electrical hazard.

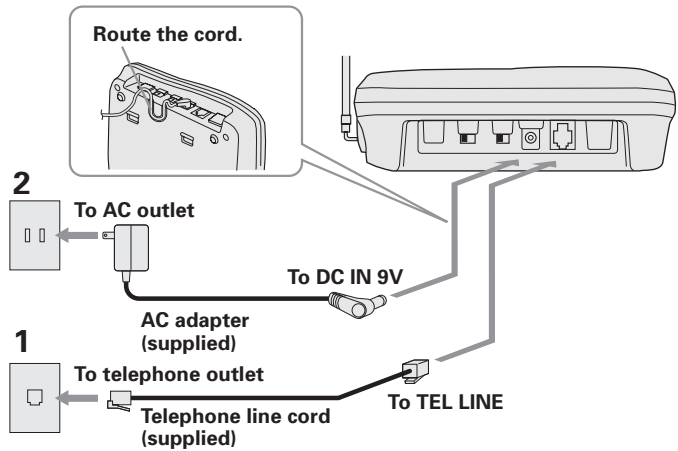

- 1** Connect the telephone line cord to the **TEL LINE** jack and to a telephone outlet.
- 2** Connect the AC adapter to the **DC IN 9V** jack and to a standard 120V AC wall outlet.
- 3** Set the base unit on a desk or tabletop and place the handset on the base unit. Then raise the antenna to a vertical position.

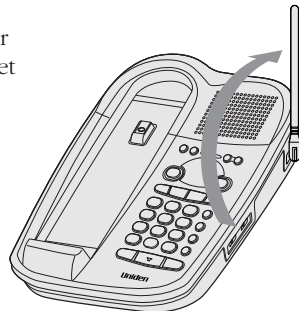



Use only the supplied AD-420 AC adapter. Do not use any other AC adapter.

Polarity of the plug

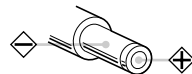

Connect the AC adapter to a continuous power supply.



Place the base unit close to the AC outlet so that you can unplug the AC adapter easily.



If your telephone outlet isn't modular, contact your telephone company for assistance.

Modular



Choose the dialing mode

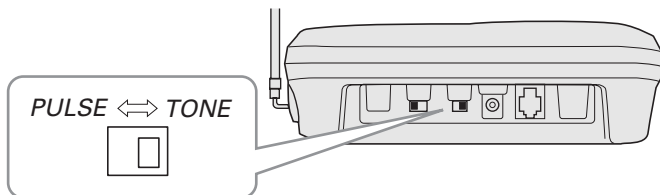

Depending on your dialing system, set the **TONE/PULSE** switch as follows:

If your dialing system is	Set the switch to
Tone	TONE
Pulse	PULSE

If you aren't sure of your dialing system

Make a trial call with the **TONE/PULSE** switch set to **TONE**. If the call connects, leave the switch as is; otherwise, set to **PULSE**.

Mounting the base unit on a wall

Standard wall plate mounting

This phone can be mounted on any standard telephone wall plate.

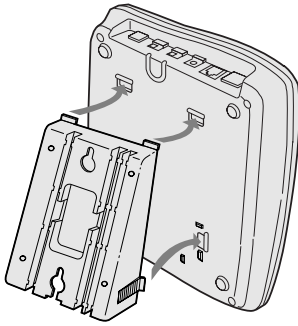
- 

1 Snap the wall mount adapter into the notches on the base.

2 Plug the telephone line cord to the **TEL LINE** jack and the AC adapter to the **DC IN 9V** jack.

3 Plug the telephone line cord into the telephone outlet.

2 - 7

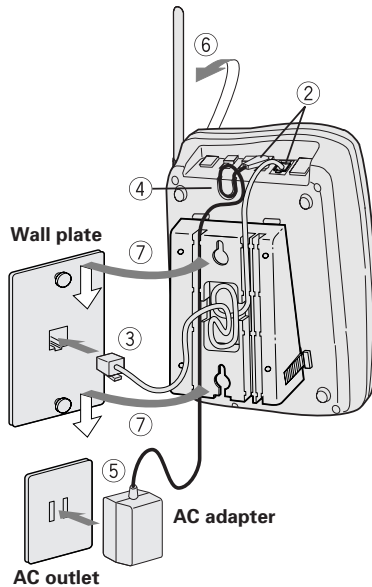

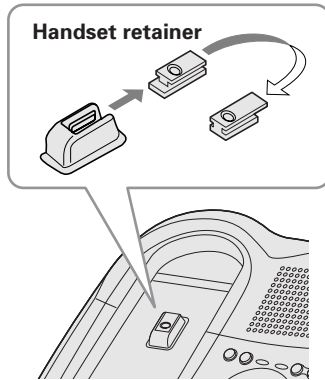

- 8** On the base unit, pull the handset retainer out of the slot. Rotate it clockwise 180 degrees.
- 9** Flip the retainer from front to back. Slide it back into the slot so that the lip of the retainer is up and the oval is down. The retainer holds the handset in place.

Direct wall plate mounting

If you don't have a standard wall plate, you can mount your phone directly to the wall. Before doing this, consider the following:

- Avoid electrical cables, pipes, or other items behind the mounting location, that could cause a hazard when inserting screws into the wall.
- Try to mount your phone within 10 - 15 feet of a working phone jack to avoid excessive cord lengths.
- Make sure the wall material is capable of supporting the weight of the base and handset.
- Use #10 screws with anchoring devices suitable for the wall material where the base unit will be placed.

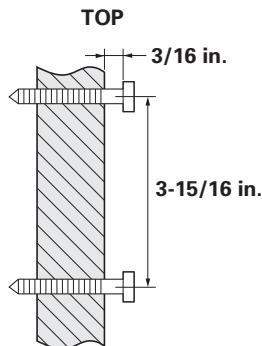



- 1** Insert two mounting screws into the wall, (with their appropriate anchoring device), $3\text{-}15/16$ inches apart. Allow about $3/16$ of an inch between the wall and screwheads for mounting the phone.
- 2** Refer to steps 1 through 9 on page 8 and 9 to mount the telephone.

Preparing the battery pack

Charge the battery pack for more than 12-15 hours before you start using your phone.

NOTE

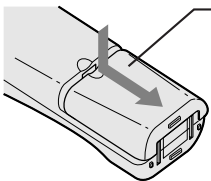
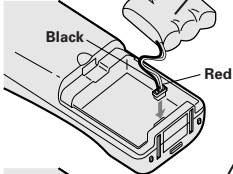
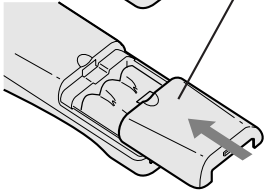
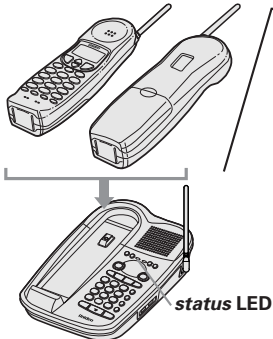
Use only Uniden Battery BT-905.

-  1 Remove the battery cover.
-  2 Connect the battery pack connector with the correct polarity (black and red wires), then insert the battery pack into the battery compartment.
-  3 Slide the battery cover forward until it snaps into place.
-  4 Place the handset on the base.

Make sure that the "**status**" LED of the base unit lights, and charging begins. Charge the battery for at least 12-15 hours. You can place the handset either side up for charging the battery.



NOTE

Even when the battery pack is not being used, it will gradually discharge over a long period. For optimum performance, be sure to return the handset to the base unit after a telephone call for charging the battery.



NOTE

Rechargeable batteries have a memory effect that reduces standby and talk time. To avoid this memory effect, on a monthly basis, use the phone until the Battery lamp blinks. Then charge the battery for 15 hours.

Battery use time (per charge)

From fully charged

- Seven hours continuous use.
- Seven days when the handset is in the standby mode.

When the battery charge becomes low

When the voltage of battery pack in the handset is very low and needs to be charged, the phone is programmed to eliminate functions in order to save power. If the battery charge becomes low Battery lamp blinks. If the phone is in use, the handset beeps. Complete your conversation as quickly as possible and return the handset to the base unit for charging.

Cleaning the battery contacts

To maintain a good charge, it is important to clean the battery contacts on the handset and base unit about once a month. Use a pencil eraser or other contact cleaner.

Do not use any liquids or solvents.

Setting the Caller ID options

There are three Caller ID options, Auto Talk, CIDCW (Caller ID with Call Waiting), and Area Code.

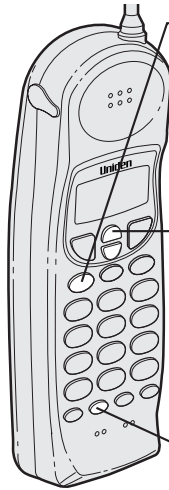

- 1 In the standby mode, hold down **call id** for 2 seconds until the Caller ID setting appears.

```
1# Auto Talk: Off
2# CIDCW      : On
3# Area Code:
```

- 2 Press **▲** or **▼** to move the cursor to the item that is to be set.

Example: To select CIDCW

```
1# Auto Talk: Off
2# CIDCW      : On
3# Area Code:
```

- 3 For Auto Talk and CIDCW press **select/ch** to toggle between on and off. For the Area Code setting please see page 13.

- 4 To complete the settings, press **call id**, then the handset returns to standby mode.

Entering your area code



If your calling area requires 10-digit dialing, skip this step.

You may wish to enter your local area code before you use this phone for the first time, or if you move to a new area. The phone can then distinguish local or long distance calls to properly dial directly from the Caller ID record. (See page 38.)



- 1** When the phone is in the standby mode, press and hold **(call id)** until the Caller ID setting screen appears.

```
1 Auto Talk:Off
2 CIDCW :On
3 Area Code:
```

- 2** Press **(3)** to select "Area Code".

```
1 Auto Talk:Off
2 CIDCW :On
3 Area Code:
```

- 3** Press **(select/ch)**.

```
1 Auto Talk:Off
2 CIDCW :On
3 Area Code:█
```

- 4** Use the dial buttons (**(0)** to **(9)**) to enter the 3-digit area code.

- 5** Press **(select/ch)**.

A beep sounds and the displayed area code is entered.

- 6** Press **(call id)** to complete the setting. Or return the handset to the base unit to complete the setting mode and set the handset to the standby mode.



When the area code has already been stored in memory, the stored area code will be displayed. To change it, use the **(del)** and dial buttons to enter the new area code.

```
1 Auto Talk:Off
2 CIDCW :On
3 Area Code:81█
```

To complete the setting, press **(call id)** or return the handset to the base unit.



The phone number can be up to 32 digits.

Making a call

From the handset

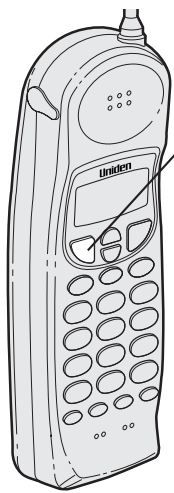

Handset on the base

- 1 Pick up handset.
- 2 Press **(talk)**.
- 3 Dial the phone number.
- 4 To hang up, press **(talk)** or return the handset to the base.

Handset off the base

- 1 Press **(talk)**.
- 2 Dial the phone number.
- 3 To hang up, press **(talk)** or return the handset to the base.

From the base

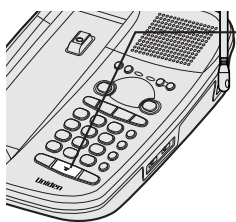

- 1 Press **(speaker)**.
- 2 Dial the number on the keypad.
- 3 To finish the call, press **(speaker)** to hang up.

Other Operations

To	Do this
To improve reception	Press (select/ch) .
To adjust the earpiece volume	Press (▲) or (▼) during the call.
To temporarily switch to tone dial (When the base is set to pulse mode)	Press (*tone/◀) . The following numbers dialed will be sent as tone dialing.
To enter a pause within dialing sequence dialed	Press (redial/p) .

Receiving a call

From the handset



- 1 Phone rings. Calling appears on the display.
- 2 Press **talk** if not in Auto Talk mode. Press any key other than mute key if in Auto Talk mode. "Talk" appears flashing on the display. Then the earpiece ear volume is displayed for 2 seconds.
- 3 The call-time display starts when you begin to talk.
- 4 Press **talk** or place the handset on the base to hang up. The call time will be displayed for about 5 seconds.

From the base

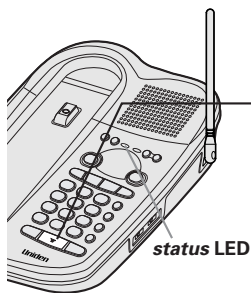

- 1 The phone rings. The **status** LED on the base flashes.
- 2 Press **speaker**.
- 3 Press **speaker** to finish the call.

Mute

You can turn off the base or the handset microphone so that the person you are talking with cannot hear you.

When speaking with the base

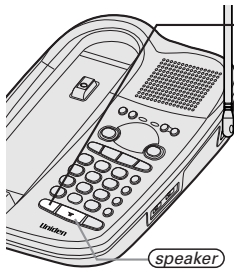

- 1 Press **mute** during a telephone call. The microphone is turned off.
- 2 To cancel mute, press **mute**, or **speaker**.

When speaking with the handset

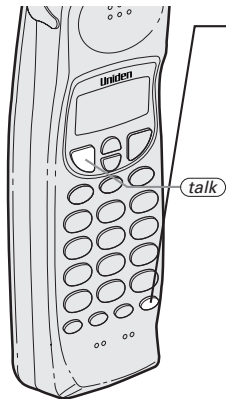

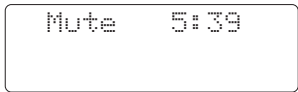
- 1 Press **mute/ring** during a telephone call.
The LCD display shows the word 'Mute' on the left and the time '5:39' on the right.
The microphone is turned off.
- 2 To cancel mute, press **mute/ring** or **talk**.

When phone is ringing

Press **mute/ring** when the phone rings. The ringer sound is turned off.

Adjusting the ringer and earpiece volume

Handset ringer tone

In the standby mode, press **(mute/ring)**.

Each time **(mute/ring)** is pressed, the ringer tone setting changes and the selected ringer tone sounds for 2 seconds.

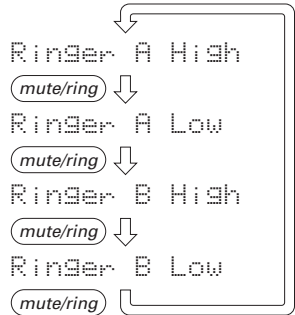

Handset ringer switch

This switch turns the handset ringer on or off.

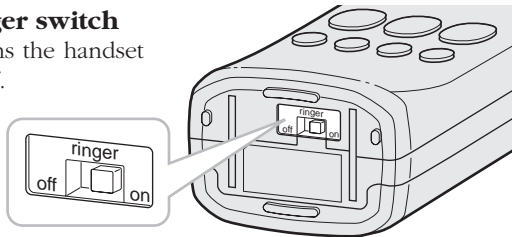

Handset earpiece volume

Pressing **(▲)** or **(▼)** during a telephone call will change the earpiece volume of the handset. This setting will remain in effect after the telephone call has ended.

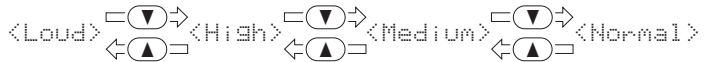

When you press **(▲)** in Loud mode or press **(▼)** in Low mode, error sound beeps.

Base ringer switch

This switch turns the base ringer on or off.

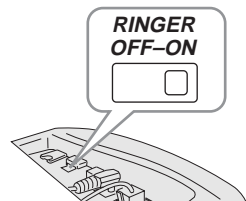

Base speaker volume

To control the speaker volume of the base, adjust the **(volume ▲)** and **(volume ▼)** button as desired.

The volume setting from 1 (lowest) to 10 (highest) appears in the message counter LED.

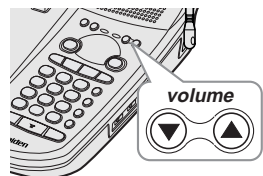

Redialing a call

From the handset

The last three phone numbers entered can be quickly redialed.

NOTE

If the recently dialed number exceeds 32 digits, only the first 32 digits are retained for redialing.



[On-hook redialing]

- 1 Press **redial/p**.
The phone number that was last dialed appears on the display.
- 2 Press **redial/p** again.
Each press of **redial/p** will display one of the last three numbers dialed.

Most recent

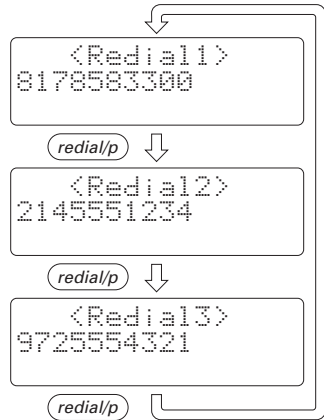

- 3 Press **talk**. "Talk" appears flashing on the display, then the volume setting is displayed.
- 4 Then the selected number is dialed. After about 5 seconds, the call-time display appears.
- 5 Press **talk** or place the handset on the base to complete the telephone call.
The call-time will be displayed for about 5 seconds.



Off-hook redialing

- 1 Press **talk**.
"Talk" appears flashing on the display.



- 2 Press **redial/p**.
The last number dialed will be displayed.
History redial cannot be accessed while off-hook.
- 3 Press **talk** or place the handset on the base to complete the telephone call.
The call-time will be displayed for about 5 seconds.

From the base

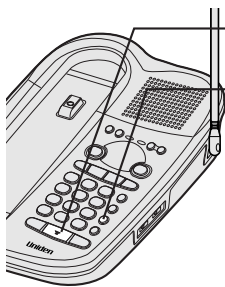

- 1 Press **speaker**.
- 2 To call the last number dialed from the base, press **redial/p**.
- 3 Press **speaker** to finish the call.

Using the speaker phone

You may use the phone as speaker phone to answer calls pressing the *(speaker)* button on the base. To hung up, press *(speaker)* again.

The base microphone is located under the phone. Position yourself approximately 12 inches away from the base and speaker clearly.

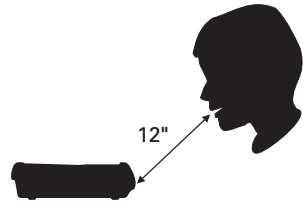

Using your EXAI 8985 intercom

Intercom from the base to handset

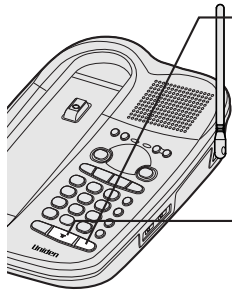

- 1** Press **page/int'com** on the base. The handset beeps.
- 2** Press **int'com** or **talk** on the handset. Speak into the mouthpiece to answer the base.
- 3** To turn off the intercom, press **talk** on the handset or **speaker** on the base.

Intercom from the handset to base



- 1** Press **int'com** on the handset. The base beeps.
- 2** At the base, press **page/int'com** or **speaker**. Speak into the base microphone to answer the page.
- 3** To turn off the intercom, press **talk** on the handset or **speaker** on the base.

Transferring a call

To transfer from the handset to the base



- 1 Press **int'com** on the handset while speaking on the handset. The line will be held, and the inter'com tone will be sounded on the base.
- 2 Press **page/int'com** or **speaker** on the base. The intercom mode is activated and the line is held.
- 3 To transfer to the base, press **talk** on the handset.
To cancel the transfer, press **speaker** on the base.

To transfer from the base to the handset

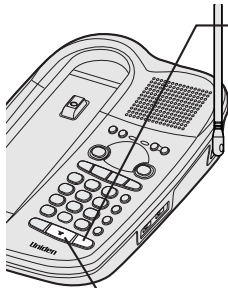

- 1 Press **page/int'com** on the base while speaking on the speaker phone. The line will be held, and the intercom tone will be sounded on the handset.
- 2 Press **int'com** or **talk** on the handset. The intercom mode is activated and the line is held.
- 3 To transfer the handset, press **speaker** on the base.
To cancel the transfer, press **talk** on the handset.

NOTE

You must press a key within 20 seconds or the phone will return to standby. If you return the handset in the cradle the phone will return to standby too. Press **mem** and you can go to memory menu at any time.

Storing phone numbers and names

Your EXAI 8985 stores up to 20 name/numbers in handset plus 10 numbers in the base.

On the handset

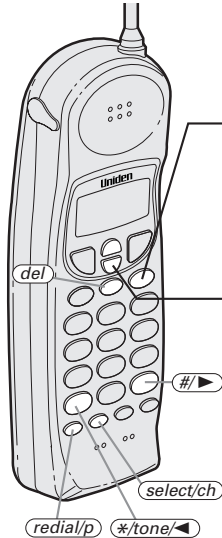

Example: To store a name (MOM AND DAD) and number (8175553300) in memory location 03.

1 Press and hold **mem** until "Memory Store" is displayed.

```
Memory Store
01 UNIDEN CORP
02 JOHN DOE
```

2 Press **▲** or **▼** to scroll to the memory number where you would like to store the number.

```
Memory Store
02 JOHN DOE
03
```

Or press the keypad (**0** to **9**) to select the memory location (01 - 20) where you would like to store the number.

Example: Enter 03











```
Location No.0
```

3 Press **select/ch**. When an empty memory location is selected, "Store Name" is displayed. The cursor flashes indicating that the display is ready for the name to be entered.

```
Store Name
```



```
Edit Memory03
Delete Memory03
Go Back
```

If this screen appears, the selected memory location is already stored. Then you must either change the entry in this location.

- 4** Use the , , , , or  keys to enter the name. The name cannot exceed 13 characters.
- Use the  and  key to scroll through the character menu. It contains upper and lower case letters, numbers, punctuation marks and various characters.
 - Use  and  to move the cursor to the desired location.
 - Use  key to delete characters as needed.

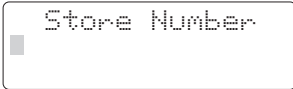
- 5** Press . “Store Number” is displayed. The cursor flashes indicating that the display is ready for the number to be entered.



- 6** Use the number keypad or , , or  keys to enter the phone number. The phone number cannot exceed 20 digits.



- Use the  key to enter pause in the dialing sequence. The display shows a “P”.



The pause feature is useful for long distance calling, credit card dialing, or sequences that require a pause between digits.

- Use the  key to delete digits as needed.

- 7** Press . The handset beeps and displays the confirmation screen. Memory storage is complete.

For example, if you store a name and number into memory location number 03, the display shows “Memory03 Stored”.

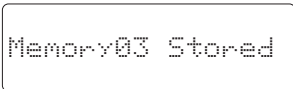

After about 2 seconds, “Memory Store” is displayed.

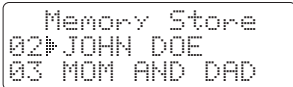

On the base



You can store only numbers in the handset

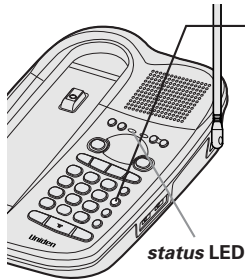

- 1** Press **memory** .
The **status** LED blinks.
- 2** Dial the number you wish to store.
- 3** Press **memory** .
Enter the memory location number (0-9) on the keypad.
The **status** LED goes out.
A confirmation beep indicates the number is stored.

Making calls with memory dialing

From the handset

NOTE

You must press key within 20 seconds or the phone will return to standby, you may also press memory to access a memory menu at any time.

NOTE

If you press **(select/ch)** before **(talk)**, you can confirm the name and number stored in the selected memory location.

NOTE

To exit the memory function without dialing, press **(mem)**. The handset returns to standby.

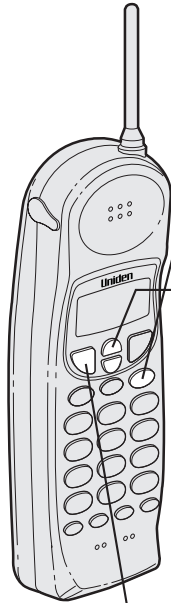

[On-hook dialing]

- 1** Press **(mem)**.
The handset displays your programmed memory locations.

```
01 UNIDEN CORP
02 JOHN DOE
03 MOM AND DAD
```

- 2** Press the **(▲)** and **(▼)** keys to select the memory location you would like to dial.

For example, if the **(▼)** key is pressed once, the cursor moves down to the next memory location number.

```
02 JOHN DOE
03 MOM AND DAD
04▶
```

Or enter the two-digit number with the number keypad to select the memory location you would like to dial.

For example, if you pressed 1, 5 on the keypad, the display shows memory location number 15 with the cursor in that line.

```
15▶ JOHN SMITH
16 <Memory16>
17
```

- 3** Press **(talk)**. "Talk" flashes and the volume setting appears on the display. Then the displayed number is dialed.

```
>Talk<
0123456789012
```

Display a Programmed Number

Use the **#/▶** and ***/tone/◀** keys to toggle between the names display and the numbers display.

Program name		Program number
01 UNIDEN CORP	◀▶	01 8178583300
02 JOHN DOE		02 5452930
03▶MOM AND DAD	▶◀	03▶8175551212



When the stored phone number has 14 or more digits, “▶” is displayed next to the 12th digit. Press **#/▶** to see the extra digits and ***/tone/◀** to return.

```
15 0123456789012
16▶011813554329+
17
```

Off-hook dialing

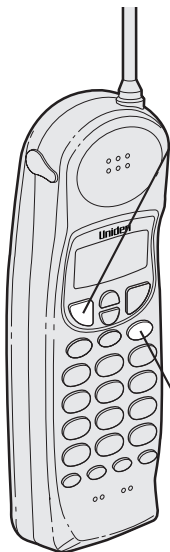

- 1 Press **talk**.
“Talk” flashes and the volume setting appears.

```
⚡Talk⚡
```



```
Talk
<High>
```

- 2 Press **mem**.

```
Talk 0:00
```

- 3 Press the number keypad to select the memory location (01 - 20) of the desired phone number.
The selected phone number is displayed. Then the number is dialed.

```
Talk 0:35
0123456789012
```

From the base

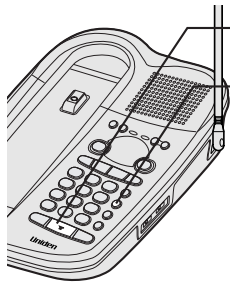

- 1 Press **speaker**.
- 2 Press **memory**.
- 3 Press the number keypad to select the memory location you wish to dial.
- 4 Press **speaker** to finish the call.

Editing a stored name and/or phone number

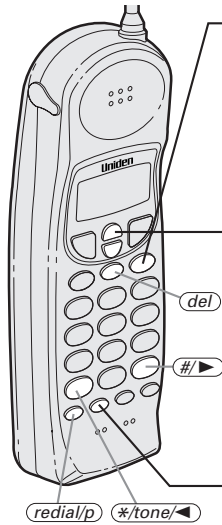

- 1 Press and hold **mem** for 2 seconds. The display shows the memory screen and any saved name/number.

```
Memory Store
01 UNIDEN CORP
02 JOHN DOE
```

- 2 Press the **▲** or **▼** keys or number keypad to select the memory location (01 - 20) you would like to edit.

```
Memory Store
01 UNIDEN CORP
02 JOHN DOE
```

(See page 23.)

- 3 Press **select/ch**.

The following screen appears with the memory location number that you have selected in the display.

For example, if you selected memory location number the display shows memory 01 as the location in the selected.

```
# Edit Memory01
Delete Memory01
Go Back
```

- 4** Press the or key to select “Edit Memory”, then press .

```
Store Name
UNIDEN CORP
```

The following screen appears.

The cursor flashes indicating that the display is ready for the name to be edited. When a name has not been stored, the cursor appears at the beginning of the second line.

- 5** Press , , , , or to edit the name. (See page 24.)

To edit only the phone number, skip this step.

- 6** Press .

```
Store Number
817858330
```

The following screen appears.

The cursor flashes indicating that the display is ready for the number to be edited.

- 7** Use the dial keypad, , or key to edit the phone number.

The phone number cannot exceed 20 digits. (See page 24.)

When the phone number will not be edited, skip this step.

- 8** Press .

The handset beeps and displays the confirmation screen. The memory storage is complete.

```
Memory01 Stored
```

For example, if you store a name and number into memory location number 01, the display shows “Memory01 stored”.

After about 2 seconds, “Memory Store” is displayed.

```
Memory Store
01 UNIDEN CORP
02 JOHN DOE
```

- 9** Press to return to standby mode.

Display a Programmed Number

Use the and key to toggle between the names display and the numbers display.

Program name

```
Memory Store
01 UNIDEN CORP
02 JOHN DOE
```

Program number

```
Memory Store
01 8178583300
02 5452930
```

- When the stored phone number has 14 or more digits, “➔” is displayed next to the 12th digit.

Press to see the extra digits and to return.

```
Memory Store
06 011813554329+
07
```

```
Memory Store
+300000
```

Erasing a stored name and phone number

With the handset



- 1** Press and hold **(mem)** for 2 seconds. The display shows the memory screen and any saved name/number.

```
Memory Store
01 UNIDEN CORP
02 JOHN DOE
```

- 2** Press the **(▲)** or **(▼)** keys or number keypad to select the memory location (01 - 20) you would like to edit.

```
Memory Store
01 UNIDEN CORP
02 JOHN DOE
```

- 3** Press **(select/ch)**. The following screen appears with the memory location number that you have selected in the display. For example, if you selected memory location number, the display shows memory 02 as the location in the selected.

```
Edit Memory02
Delete Memory02
Go Back
```

- 4** Press **(▼)** to move the cursor down to "Delete Memory" command line.

```
Edit Memory02
Delete Memory02
Go Back
```

- 5** Press **(select/ch)**. The following confirmation screen appears.

```
Delete Memory02?
Yes
Delete
```

- 6** Press **(▲)** to move the cursor to "Yes".

- 7** Press **(select/ch)** or **(del)**. There is a confirmation tone and the entry is deleted. The following screen appears.

For example, if memory location number 02 is selected for deletion, the following display appears as the confirmation screen.

```
Memory02 Deleted
```

- 8** After 2 seconds the display returns to the "Memory Store" screen. You may select another number to delete (return to step 4).

```
Memory Store
02▶
03 MOM AND DAD
```

- 9** Press **mem** to return to standby.

With the base

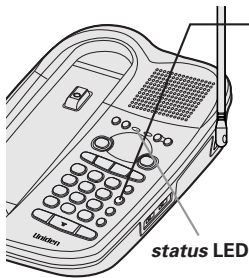

- 1** Press **memory** .
The **status** LED blinks.
- 2** Press **memory** again.
- 3** Enter the memory location number (0-9) of the number you wish to delete. The **status** LED goes out.
A confirmation beep indicates the number has been erased.

NOTE

Dialing from the 3-way conversation mode is possible only from the handset.

3-way conferencing

The Uniden EXAI 8985 permits 3-way conversations between the handset, base, and outside line.



When speaking on the handset

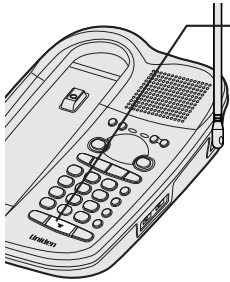

- 1 Press **speaker** on the base to join the 3-way conversation. This will set the 3-way conversation mode.
- 2 Press **speaker** on the base to hang up. The handset remains connected to the outline call.

When speaking on the base

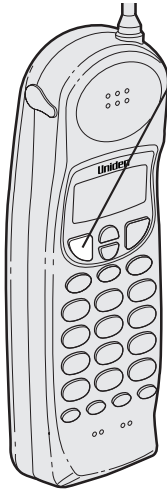

- 1 Press **talk** on the handset to join the 3-way conversation.
- 2 Press **talk** on the handset to hang up.

Caller ID service

You must subscribe to the Caller ID service from your telephone company to use this feature.

When the telephone rings, the Caller ID feature allows you to view the caller's name and phone number on the display before you answer the phone.

The handset displays the phone number of the incoming call, the name, time, and the number of calls. Additionally, you can dial the displayed number, and store the information for memory dialing.

When the telephone rings

NOTE

If you answer a call before the Caller ID message is received (Example: before the second ring), the Caller ID message will not appear.

NOTE

When the call is received via a telephone company that does not offer Caller ID service, the caller's phone number and name do not appear. (This includes international calls.)

NOTE

When the call is via a private branch exchange (PBX), the caller's phone number and name may not appear.

- 1 When the Caller ID message is received, the **status** LED blinks.

The display shows the caller's phone number, along with the date and time. The incoming call information is stored in Caller ID record.

If the Caller ID service includes the caller's name, the caller's name appears on the display (up to 15 letters).

The date and time received — 5/11 12:30PM 01
 Caller's name — UNIDEN CORP
 Caller's phone number — 813-858-3300

Here are some typical displays;

When the phone number and name data are received

```
5/11 12:30PM 01
UNIDEN CORP
817-858-3300
```

When invalid data is received

```
Incomplete Data
```

When a private name is received

```
5/11 12:30PM 01
Private Name
817-858-3300
```

When a private number is received

```
5/11 12:30PM 01
UNIDEN CORP
Private Number
```

When an unknown name is received

```
5/11 12:30PM 01
Unknown Name
817-858-3300
```

When an unknown number is received

```
5/11 12:30PM 01
UNIDEN CORP
Unknown Number
```

- 2 When the telephone is answered, the display changes to "Talk".

NOTE

Data errors appear as "■ ■".

```
5/11 12:30PM 01
UNI■EN CORP
813-8■-3300
```

NOTE

If a call comes in via a telephone system that does not offer Caller ID service, no information is stored.

NOTE

"End" appears when you have received all messages in the Caller ID list.

NOTE

Press **▲** to return to the summary screen.

NOTE

Each message can be up to 15 characters for the phone number and the name.

Viewing the Caller ID Message list

The Caller ID list stores information for up to 50 incoming calls - even unanswered calls.

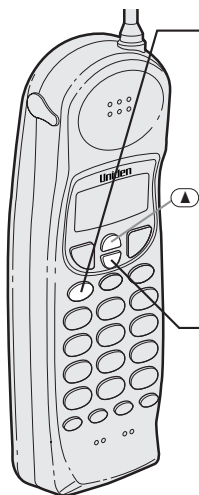

- 1 Press **call id** .
When there are new messages you have not reviewed, "New" and the number of calls are displayed. The summary screen shows how many new calls are stored, along with the total of new calls and old calls stored in the list.

```
New :01
Total:02
```

- 2 Press **▼** to display the latest caller ID message.

```
5/17 12:30PM 03
UNIDEN CORP
817-858-3300
```

- 3 Press **▼** to see the next message.
Or press **▲** to see previous message.

- 4 Press **call id** to return to standby.

Long Distance call settings and cancellation

Press **1** while the incoming call information is displayed (in step 2) to return a long distance call. The prefix "1-" will be displayed at the beginning of the phone number when a long distance call is set. (When the phone number is 15 digits long, only "1" is displayed.) Pressing **1** again will cancel the long distance call setting.

```
5/17 12:30PM 03
UNIDEN CORP
1-817-858-3300
```

Deleting information from the Caller ID list

The EXAI 8985 stores up to 50 messages. If more new calls are received, messages stored in the list are deleted beginning with the oldest message in the list.

Caller ID data can also be deleted manually.

Deleting a Caller ID message

NOTE

While using the "Delete Message ?" screen, if no key is pressed for more than 20 seconds, an error tone sounds and the telephone returns to standby.

NOTE

If you get an incoming call, the deleting operation is cancelled and the telephone returns to standby so you can answer the call.

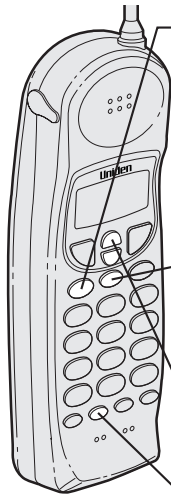

- 1** Press **(call id)**.
Display the message to be deleted from the Caller ID list by pressing **(▲)** or **(▼)**.

```
5/17 12:30PM 03
UNIDEN CORP
817-858-3300
```

- 2** Press **(del)**.

```
Delete Message ?
Yes
No
```

- 3** Press **(▲)** or **(▼)** to select "Yes" or "No".

- 4** Press **(select/ch)** or **(del)**.

When the pointer is at "Yes":
A beep tone sounds and the next Caller ID message displayed.

When the pointer is at "No":
The display returns to the Caller ID display.

Deleting all Caller ID name/numbers

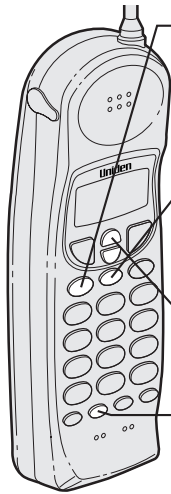

1 Press **(call id)**.

```
New :01
Total:02
```

2 Press **(del)**.

```
Delete All ?
Yes
No
```

3 Press **(▲)** or **(▼)** to select "Yes" or "No".

4 Press **(select/ch)** or **(del)**.

When the pointer is at "Yes":

A beep tone sounds and all stored Caller ID messages are deleted.

```
Total:00
```

When the pointer is at "No":

The display returns to the summary screen.

```
New :01
Total:02
```

Using the Caller ID list

Calling a party from the Caller ID list

You can place a call from the Caller ID list.
The EXAI 8985 stores up to 50 messages.

NOTE

When a long distance call has been set, "1" appears in the display.

NOTE

You cannot make a call from the Caller ID list if your EXAI 8985 is connected to private branch exchange (PBX).

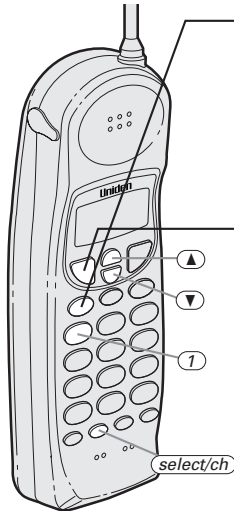

- 1 Press **call id**.
Select the phone number that you want to dial by pressing **▲** or **▼**.

```
5/17 12:30PM 03
UNIDEN CORP
817-858-3300
```

- 2 Press **talk**.

```
Talk
8178583300 ■
```

The displayed phone number dials automatically.

Long Distance calls

Pressing **1** while the incoming call information is displayed (in step 1) will set or cancel a long distance call.

Dial edit

You can edit the phone number of Caller ID data when you press **select/ch** after the step 1.

```
UNIDEN CORP
8178583300 ■
```

Storing Caller ID messages in Memory dialing

Messages shown in the Caller ID list can be stored in memory dialing.

Using the incoming call information (i.e., Caller ID list), the phone number of the party on the Caller ID list can be stored in memory dialing.

NOTE



You can not store a Caller ID message if no phone number appears in the message.

NOTE

If no key is pressed for more than 20 seconds, an error tone sounds and the telephone returns to the standby mode.

NOTE

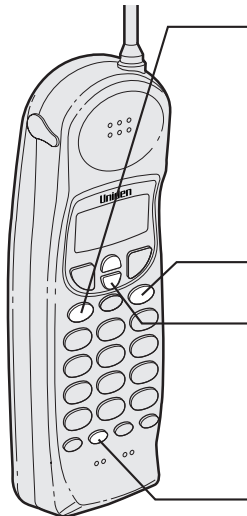
If there is an incoming call or page, memory storage is cancelled and the telephone is set to receive the incoming call or page.

- 
- 1 Press **(call id)**.
Select the phone number to be stored from the Caller ID list by pressing **(v)** or **(^)**.

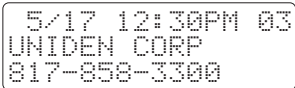
 - 2 Press **(mem)**.
 - 3 Press **(v)** or **(^)** to select the memory location.

 - 4 Press **(select/ch)**.
A beep tone will sound. The number is stored in memory, and the display returns to the Caller ID list.

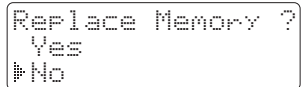

If a message has already been stored in the selected memory numbers location, a confirmation screen is displayed. Press **(^)** to select "Yes". Press **(select/ch)** to overwrite. The display returns to the Caller ID list.



Using "Caller ID with call waiting" service

"Caller ID" and "Call waiting" are separate services. CIDCW (Caller ID on Call Waiting) performs the same as regular Caller ID on a call waiting number. You must subscribe to the "Caller ID with call waiting (CIDCW)" service from your telephone company before you can use the following features. The "Call waiting" service can also be used independently. Please contact your telephone company for details.



- 1** When a new incoming call arrives during your current telephone call, the phone number and the name of the caller is displayed.

```
Talk 10:30  
UNIDEN CORP  
817-858-3300
```

- 2** Press **(flash)**.
You will be able to talk with the person that has just called. The first caller will be put on hold.
- 3** To return to the first caller, press **(flash)** again.

The integrated answering device

The EXAI 8985 has a built-in answering system that answers and records incoming calls.

You can also use your answering system to record a conversation, leave a voice memo message for others who use the phone, or to announce a special message to callers when you're away from your phone.

Features

- Digital Tapeless Recording
- 15 minutes of Recording Time
- Selective Outgoing Message (Greeting)
- Time and Day Stamp
- Remote Message Retrieval and Room Monitor
- Toll Saver
- Conversation Recording

Digital Tapeless Recording allows you to quickly review, save or delete the messages. You'll never have to worry about a tape wearing out, jamming, or resetting improperly.

The Integrated Answering System is easy and convenient to use, but please read through all of the instructions carefully.

Setting up your answering system

Turning the answering system on/off

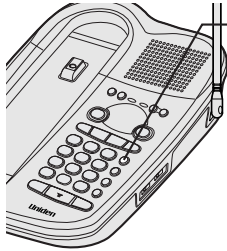

- 1 To turn the answering system on, press **ans on/off**. A beep tone will sound and the current greeting message is played.
- 2 To turn the answering system off, press **ans on/off** again.

Setting the clock

The clock on EXAI 8985 Answer System starts when power is applied to the base. Follow these steps to set the clock to the correct time.

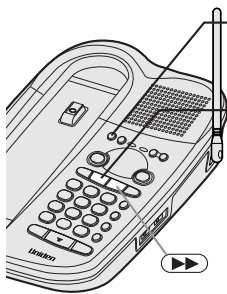

- 1 Press and hold **clock** until a beep tone sounds.
- 2 First, press **▶▶** or **◀◀** until the correct day of the week is announced. (Number zero through six displays on the base as each day is announced.) Press **clock** again to select the day.
- 3 Next, press **▶▶** or **◀◀** until you hear the correct hour setting. Numbers 1 through 12 display on the base as each hour is announced. Press **clock** again to select the correct time.

- 4 Press **▶▶** or **◀◀** until you hear the correct time setting. Numbers 1 through 59 display on the base as each minute is announced. Press **clock** again to select the correct time.
- 5 The LED displays an A or P. Press **▶▶** or **◀◀** until you hear the correct AM/PM setting.
- 6 Press **clock** again to end the time/day setting. The EXAI 8985 announces the time that you have set.

NOTE

Press **▶▶** or **◀◀** multiple times to scroll through days, hours, minutes, etc.

NOTE

If you don't set the clock within two minutes, the system returns to standby.

Setting your greeting

When you receive a call, the answering system automatically plays either a preset message or your own greeting.

▼ Preset Message

The following message is prerecorded:

"Hello, no one is available to take your call. Please leave a message after the tone."

▼ Recording your personal greeting

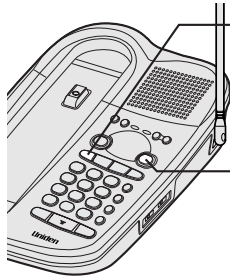

- 1 Press and hold **(greeting)** until you hear a long tone. Start recording your message immediately after you hear the long tone end.
- 2 When you finish recording your message, press **(greeting)** or **(play)**. A long tone sounds and your message plays back on the phone.

NOTE

You can record a greeting up to 30 second.

NOTE

Stand within 12 inches in front of the microphone and speak clearly when recording your greeting.

▼ Choosing between two greetings

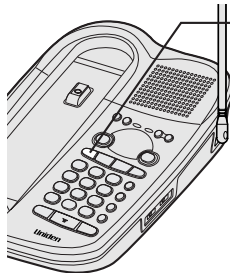

- 1 Press **(greeting)** to play the outgoing message.
- 2 While the message is playing, press **(greeting)** again to select between your personal greeting and the prerecorded message.

Selecting the message record time

You can set your answering system to record messages up to one or four minutes long.

One minute option:
move the **REC TIME** switch to **1**.

Four minutes option:
move the **REC TIME** switch to **4**.

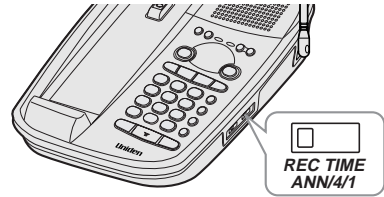

▼ Announce only feature:

The announce only feature plays an outgoing message, but it will not allow the caller to leave a message. Move the **REC TIME** switch to the **ANN** position.

The message counter LED displays "A" when system is on standby.

Prerecorded outgoing message for Announce only feature is:

"Hello, no one is available to take your call."

Selecting a PIN code

To play your messages from a remote location, you will need to enter a two-digit Personal Identification Number (PIN) code (00-99). To select a PIN, perform the following steps.



Press **▶▶** or **◀◀** multiple times to scroll through numbers on the display.

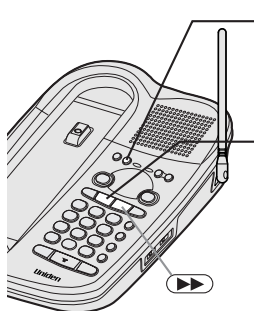

- 1** On the base, press and hold **(pin)** button until beep sounds, and the LED displays 00.
- 2** To set the first number, press **▶▶** or **◀◀** to scroll from 00 to 90. When the desired number appears in the display, press **(pin)**. This selects the first number.
- 3** To set the second number, press **▶▶** or **◀◀** to scroll from 0 to 9. When the desired number appears in the display, press **(pin)**. This selects the second number and then the entered number is announced.

Setting ring time switch

The ring time /toll saver switch allows you to set the number of rings the caller hears before the answering system plays your outgoing message. You can set the switch to answer after two rings or after four rings. In the

TS (Toll Saver) position, the answering system picks up after two rings if you have new messages, and after four rings if there are none. This way, if you call long distance to check your messages, you can hang up after third ring to avoid billing charges.

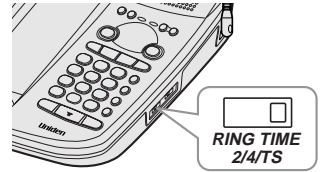

Using your answering system

NOTE

To stop playing your messages, press **(play)** again.

Playing your message

The base LED shows the number of total messages on the display. If the display is blinking, then there are new messages waiting for you. The EXAI 8955 is designed to play your new messages first. After you play your new messages you can then play your old messages.

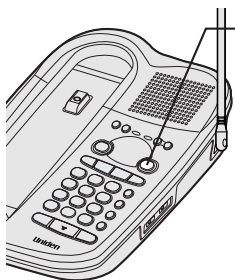

- 1** Press **(play)**. The system announces the number of new and old messages, then the incoming messages are played. The time and day each message was received is announced after the message is played, and the message counter LED displays the number of the current message.
- 2** When all new messages have played, a long tone is heard. The message counter LED stops flashing to indicate that all of the new messages have been reviewed.
- 3** After you have reviewed all your messages, you can play your old messages again. Press **(play)** and follow the instructions above.

NOTE

Pressing **◀◀** before 2.5 seconds (4.5 seconds from remote) of the message has played causes the system to scan back one message.

TIP

If you have several messages, press **◀◀** until you return to the message you want to replay.

NOTE

Each time **▶▶** is pressed, the system scans forward one message.

NOTE

If you have several messages, press and hold **▶▶** to find the message you want to play.

Repeating a message

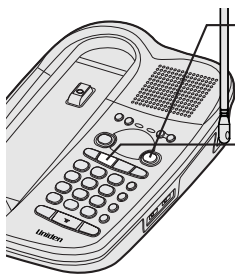

- 1 Press **play** to review your message. The number of stored messages is announced.
- 2 After a message has played for a few seconds, press **◀◀** to repeat the message.
- 3 Press **play** at any time to stop reviewing messages and return to standby. The message counter LED shows the total number of messages still on the system.

Skipping a message

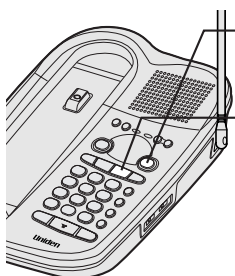

- 1 Press **play** to review your messages. The number of messages is announced.
- 2 Press **▶▶** at anytime to skip to the next message.
- 3 Press **play** at any time to stop reviewing your messages and return to standby. The message counter LED shows the total number of messages on the system.

NOTE

When you press delete, you are permanently deleting the message. Once deleted, the message cannot be replayed.

NOTE

The voice memo function is completely independent of the outgoing message. It's handy for leaving others a quick message.

NOTE

A memo message is treated as a typical recorded message and will be added to the stored messages.

Deleting a message

▼ Deleting individual message

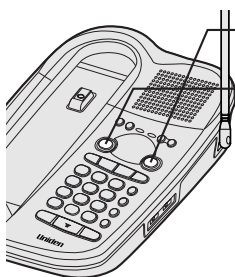

- 1 Press **(play)** to review your message.
- 2 If you decide to delete a message, press **(delete)** anytime during the message. The system beeps and immediately goes to the next message.
- 3 After you have played all of your messages, a long tone sounds on the base speaker.

▼ Deleting all messages

Press and hold **(delete)** after reviewing your messages. A tone sounds when all messages are cleared.

Voice memo

The voice memo function allows the user to record a message (up to 10 minutes) on the base.

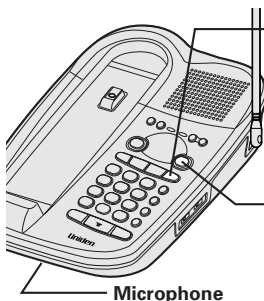

- 1 Press and hold **(voice memo)**, until you hear a long beep. The message counter LED blinks.
- 2 Speak into the microphone.
- 3 When you have finished, press **(voice memo)** or **(play)** to stop recording. The system returns to standby.

NOTE

A recorded conversation is treated as a typical message and will be added to the stored messages.

NOTE

You cannot record a conversation while speaking on the base.

Recording a conversation

You can record up to 10 minutes of conversation while you are making your call from the handset.

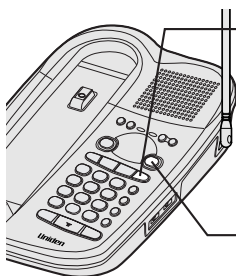

1 During the conversation from the handset. Press and hold **voice memo** on the base. The unit begins recording and the LED blinks. A beep that can be heard by both parties sounds every 15 seconds.

2 To stop the recording, press **voice memo** or **play**.

Remote access away from home

You can operate your answering system from a remote location using any touch-tone telephone. Use this function to check for recorded messages, to play or delete messages, even to record a new outgoing message, and to monitor sounds in the room.

- 1 Call your telephone number.
- 2 While the answering machine is activated, press **#** and your PIN code.
- 3 The answering system announces the time and day stamp and the number of messages stored in memory. Then the message playback automatically begins.
- 4 You may continue to listen to your message, or you may select a command from the following chart.

Command	Function
# then 1	Repeat
# then 2	Playing your messages
# then 3	Skipping a message
# then 4	Deleting a message
# then 5	Stop message playback
# then 6	Answering system on
# then 7	Voice memo record/stop
# then 8	Outgoing message record/stop
# then 9	Answer system off
# then *	Room monitor

- 5 After all of your messages have played, or the playback time exceeds 4 minutes, you will hear that the intermittent beeps indicating that the system is in the command waiting mode. You may enter another command at this time from the chart above.
- 6 When you are finished, hang up to exit the system. The answering system automatically returns to standby.



NOTE

You must enter a command within 15 seconds of entering command waiting mode or the answering system automatically hangs up and returns to standby.



NOTE

The system will only playback messages for four minutes and then it returns to command waiting mode. To continue playing your message, press **#** then **2** again within 15 seconds

Remote room monitor

You can call your answering system from any touch-tone phone and monitor sounds in the room where your base is installed.

- 1** Call your telephone number.
- 2** While the answering machine is activated, press **#** and your PIN code.
- 3** The answering system begins announcing the time and day.
- 4** Press **#** then **5** to stop the message.
- 5** Press **#** then ***** while the system announces the time and day stamp. You hear sounds in the room where your phone is installed. After 15 seconds, the answering system returns to the command waiting mode.
- 6** Press **#** then ***** to monitor the room for another 15 seconds. Or select another remote function. Or hang up to exit the system. The answering system automatically returns to standby.

Changing the digital security code

NOTE

If the handset battery pack is completely discharged or the battery pack is removed, the digital security code will be lost. If this happens, a new security code is set automatically the next time the battery pack is charged.

The digital security code is an identification code used to connect the handset and the base unit. Normally, setting the code is not necessary.

The first time you charge your handset, the security code is automatically set. (See page 3.)

In the rare situation that you suspect another cordless telephone is using the same security code, you can change the code.

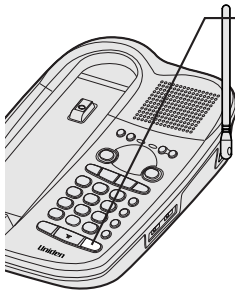

- 1** Remove the handset from the base unit. Press **page/int'com**.
- 2** While the handset is producing the paging sound, hold **page/int'com** while placing the handset in the base unit. The paging tone stops. Leave the handset on the base longer than 3 seconds. A random, new security code is set.

ADDITIONAL

INFORMATION

Installing the beltclip

To attach the beltclip

Insert the beltclip into the holes on each side of the handset. Press down until it clicks.

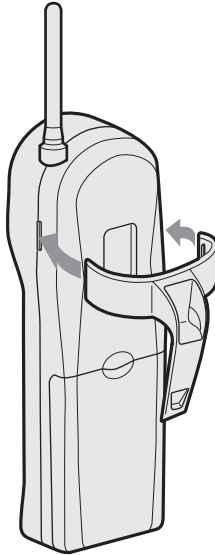

To remove the beltclip

Pull both sides of the beltclip to release the tabs from the holes.

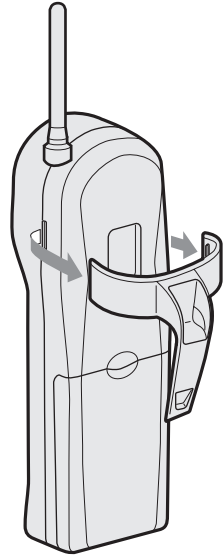

Headset installation

Your phone may be used with an optional headset. To use this feature, simply plug any standard 2.5mm headset plug into the headset jack. Your phone is ready for hands-free conversation.

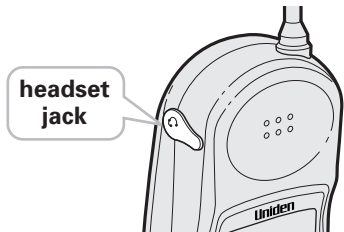

Note on power sources

Battery replacement and handling

When the operating time becomes short, even after a battery is recharged, please replace the battery.

With normal usage, your battery should last about one year.

Please contact your place of purchase for a replacement battery.

Power Failure

During the period that the power is off, you will not be able to make or receive calls with the telephone.

RECYCLING NICKEL-CADMIUM BATTERIES

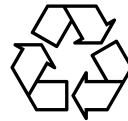

Ni-Cd

NICKEL-CADMIUM BATTERIES MUST BE DISPOSED OF PROPERLY.

Nickel-cadmium cells are used in the battery pack. Please take your used nickel-cadmium battery packs to a store that recycles nickel-cadmium batteries.

Caution

- Use the specified battery pack.
- Do not remove the battery from the handset to charge it.
- Never throw the battery into a fire, disassemble it, or heat it.
- Do not remove or damage the battery casing.

Maintenance

When slightly dirty

Wipe with a soft, dry cloth.

When very dirty

Wipe with a soft cloth that has been dampened with diluted, neutral detergent. Dry with a dry cloth.

When the charging terminals become dirty

Wipe with a pencil eraser or other contact cleaner.

Caution

Do not use paint thinner, benzene, alcohol, or other chemical products. Doing so may discolor the surface of the telephone and damage the finish.

Troubleshooting

If your phone is not performing to your expectations, please try these simple steps first.

Symptom	Suggestion
The status light won't come on when the handset is placed in the base unit.	<ul style="list-style-type: none"> • Make sure the AC adapter is plugged into the base unit and wall outlet. • Make sure the handset is properly seated in the base unit. • Make sure the charging contacts on the handset and base unit are clean.
The audio sounds weak and/or scratchy.	<ul style="list-style-type: none"> • Make sure that the base unit antenna is in a vertical position. • Move the handset and or base unit to a different location away from metal objects or appliances and try again. • Press (select/ch) to help eliminate background noise. • Make sure that you are not too far from the base.
Can't make or receive calls.	<ul style="list-style-type: none"> • Check both ends of the base unit telephone line cord. • Make sure the AC adapter is plugged into the base unit and wall outlet. • Disconnect the AC adapter for a few minutes, then reconnect it. • Reset the digital security code (See page 52). • Make sure (talk) is pressed.
The handset doesn't ring or receive a page.	<ul style="list-style-type: none"> • The battery pack may be weak. Charge the battery on the base unit for 12-15 hours. • The handset may be too far away from the base unit. • Place the base unit away from appliances or metal objects. • Reset the digital security code (See page 52).

Symptom	Suggestion
The caller ID disappears.	<ul style="list-style-type: none"> • The handset was picked up before the second ring. • The call was placed through a switch board.
The caller ID does not display	<ul style="list-style-type: none"> • Call your local telephone company to verify your Caller ID service is current.
The answering system does not work.	<ul style="list-style-type: none"> • Make sure the base unit is plugged in. • Make sure that the answering system is turned on.
Messages are incomplete.	<ul style="list-style-type: none"> • The incoming messages may be too long. Remind callers to leave a brief message. • The memory may be full. Delete some or all of the saved messages.
After a power failure, the outgoing message is deleted.	<ul style="list-style-type: none"> • Record your greeting again. The default messages should remain.
No sounds on the base unit speaker during call monitoring or message playback.	<ul style="list-style-type: none"> • Adjust the speaker volume on the base unit.
Cannot access remote call-in features from another touch-tone phone.	<ul style="list-style-type: none"> • Make sure you are using the correct PIN number. • Make sure that the touch-tone phone you're using can transmit the tone for at least two seconds. If it cannot, you may have to use another phone to access your message.

Specifications

General

The EXAI 8985 complies with FCC Parts 15 and 68.
 Frequency control: PLL
 Modulation: Frequency shift keying
 Operating temperature: 0°C to +50°C (+32°F to +122°F)

Base unit

RX frequency: 902.119 MHz to 905.016 MHz (30 channel)
 TX frequency: 924.997 MHz to 927.894 MHz (30 channel)
 Power requirements: 9V 350mA (from AC adapter)
 Size: 8-49/64 in. (W) x 6-57/64 in. (D) x 2-37/64 in. (H)
 (222.5 mm (W) x 175 mm (D) x 65.3 mm (H))
 Weight: Approx. 21 oz. (Approx. 594 g)

Handset

RX frequency: 924.997 MHz to 927.894 MHz (30 channel)
 TX frequency: 902.119 MHz to 905.016 MHz (30 channel)
 Power requirements: Rechargeable Nickel-Cadmium battery pack
 Size (without antenna): 7 in. (W) x 2-17/64 in. (D) x 2 in. (H)
 (178 mm (W) x 57.6 mm (D) x 51 mm (H))
 Weight: Approx. 9 oz. (254 g) (including battery)
 Battery: BT905
 Capacity 600 mAh, 3.6V
 Talk mode 7 hours TYP
 Standby mode 7 days TYP

Specifications, features, and availability of optional accessories are all subject to change without prior notice.

At Uniden, we'll take care of you!

If you need any assistance with this product, please call our Customer Hotline at

1-800-297-1023

PLEASE DO NOT RETURN THIS PRODUCT TO THE PLACE OF PURCHASE.

Our Uniden representatives will be happy to help you with any matters regarding the operation of this unit, available accessories, or any other related matters.

Thank you for purchasing a Uniden product.
 Hours: M-F 7:00 AM to 7:00 PM CST.

Index

0 - 9

3-way conferencing.....32

A

Answering device
 Features.....41
 Setting up.....42
 Using.....46

B

Base ringer switch.....17
 Battery pack
 Preparing and charging..10
 Replacement and
 handling.....54

C

Caller ID
 Caller ID service.....33
 Call Waitong.....40
 Deleting.....36
 Using.....38
 Viewing.....35
 Channel.....14
 Connection.....6

D

Dialing mode.....7
 Digital security code.....3, 52

E, F, G

Earpiece volume.....17

H

Headset installation.....53

I, J, K, L

Intercom.....21
 Installing the beltclip.....53

M, N, O

Maintenance.....54
 Making a call.....14
 Memory dialing
 Making a call
 with memory dialing.....26
 Erasing a stored name
 and phone number.....30

Storing phone

numbers and names.....23

Mounting the base unit
 to a wall.....8
 Mute.....16

P, Q

Package contents.....4

R

Receiving a call.....15
 Redialing a call.....18
 Handset ringer tone.....17
 Handset ringer switch.....17

S

Setting up your answering
 system
 Selecting a PIN code.....44
 Selecting the
 message record time.....44
 Setting the clock.....42
 Setting ring time switch.....45
 Setting your greeting.....43
 Tuerning the answering
 system on/off.....42
 Setting up the Base unit.....5
 Setting up the Handset.....10
 Specifications.....57

T

Transferring a call.....22
 Troubleshooting.....55

U, V, W, X, Y, Z

Using your answering system
 Deleting a message.....48
 Playing your message.....46
 Recording a
 conversation.....49
 Remote access
 away from home.....50
 Remote room monitor....51
 Repeating a message.....47
 Skipping a message.....47
 Voice memo.....48

THANK YOU

FOR PURCHASING A UNIDEN PHONE!

Uniden®

Covered under one or more of the following U.S. patents:

4,511,761 4,523,058 4,595,795 4,797,916 5,381,460
5,426,690 5,434,905 5,491,745 5,533,010 5,574,727
5,650,790 5,660,269 5,661,780 5,663,981 5,671,248
5,717,312 5,754,407 5,768,345 5,787,355 5,838,721

© May 1999 Uniden America Corporation

All rights reserved • Printed in China UCZZ01624BZ

Free Manuals Download Website

<http://myh66.com>

<http://usermanuals.us>

<http://www.somanuals.com>

<http://www.4manuals.cc>

<http://www.manual-lib.com>

<http://www.404manual.com>

<http://www.luxmanual.com>

<http://aubethermostatmanual.com>

Golf course search by state

<http://golfingnear.com>

Email search by domain

<http://emailbydomain.com>

Auto manuals search

<http://auto.somanuals.com>

TV manuals search

<http://tv.somanuals.com>