

# uniden®

## ANA 9610

### 900 MHz Analog PBX

### Cordless Telephone

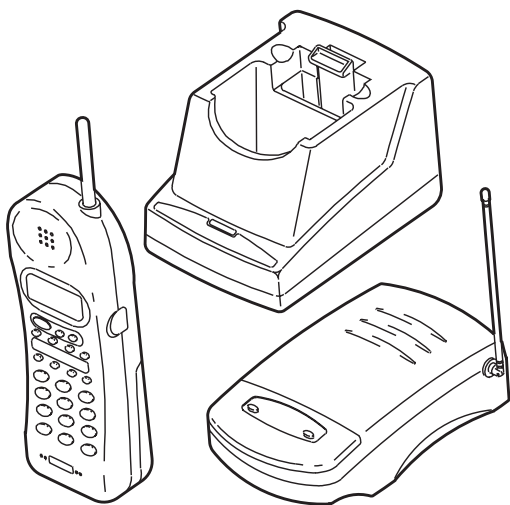

## Operating Guide

---

# One Year Limited Warranty

---

**WARRANTOR:** UNIDEN AMERICA CORPORATION (“Uniden”)

**ELEMENTS OF WARRANTY:** Uniden warrants, for one year, to the original retail owner, this Uniden Product to be free from defects in materials and craftsmanship with only the limitations or exclusions set out below.

**WARRANTY DURATION:** This warranty to the original user shall terminate and be of no further effect 12 months after the date of original retail sale. The warranty is invalid if the Product is (A) damaged or not maintained as reasonable or necessary, (B) modified, altered, or used as part of any conversion kits, subassemblies, or any configurations not sold by Uniden, (C) improperly installed, (D) serviced or repaired by someone other than an authorized Uniden service center for a defect or malfunction covered by this warranty, (E) used in any conjunction with equipment or parts or as part of any system not manufactured by Uniden, or (F) installed or programmed by anyone other than as detailed by the Operating Guide for this product.

**STATEMENT OF REMEDY:** In the event that the product does not conform to this warranty at any time while this warranty is in effect, warrantor will repair the defect and return it to you without charge for parts, service, or any other cost (except shipping and handling) incurred by warrantor or its representatives in connection with the performance of this warranty. **THE LIMITED WARRANTY SET FORTH ABOVE IS THE SOLE AND ENTIRE WARRANTY PERTAINING TO THE PRODUCT AND IS IN LIEU OF AND EXCLUDES ALL OTHER WARRANTIES OF ANY NATURE WHATSOEVER, WHETHER EXPRESS, IMPLIED OR ARISING BY OPERATION OF LAW, INCLUDING, BUT NOT LIMITED TO ANY IMPLIED WARRANTIES OF MERCHANTABILITY OR FITNESS FOR A PARTICULAR PURPOSE. THIS WARRANTY DOES NOT COVER OR PROVIDE FOR THE REIMBURSEMENT OR PAYMENT OF INCIDENTAL OR CONSEQUENTIAL DAMAGES.** Some states do not allow this exclusion or limitation of incidental or consequential damages so the above limitation or exclusion may not apply to you.

**LEGAL REMEDIES:** This warranty gives you specific legal rights, and you may also have other rights which vary from state to state. This warranty is void outside the United States of America.

**PROCEDURE FOR OBTAINING PERFORMANCE OF WARRANTY:** If, after following the instructions in this Operating Guide you are certain that the Product is defective, pack the Product carefully (preferably in its original packaging). Include evidence of original purchase and a note describing the defect that has caused you to return it. The Product should be shipped freight prepaid by traceable means, or delivered, to warrantor at:

Uniden America Corporation  
BCS Division  
4700 Amon Carter Blvd.  
Fort Worth, TX 76155  
817-252-3043, 8 a.m. to 5 p.m. Central,  
Monday through Friday

Covered under one or more of the following U.S. patents:

4,511,761

4,523,058

4,595,795,

4,597,104

4,797,916

4,803,491

5,157,686

5,253,268

and other patents pending.

**uniden®**

# PRECAUTIONS

Before you read anything else,  
please observe the following:

---

## WARNING!

Uniden America Corporation **DOES NOT** represent this unit to be waterproof. To reduce the risk of fire, electrical shock, or damage to the unit, **DO NOT** expose this unit to rain or moisture.

---

### BATTERY WARNING

- This equipment contains a Rechargeable Sealed Lead-Acid Battery.
- **Do not** short circuit the battery.
- **Do not** charge the Rechargeable Sealed Lead-Acid Battery used in this equipment in any charger other than the one designed to charge this battery as specified in this Guide . Using another charger may damage the battery, or cause the battery to explode.



The exclamation point within an equilateral triangle is intended to alert the user to the presence of important operating and maintenance (servicing) instructions in the literature accompanying the appliance.

---

# Handset Controls & Functions

---

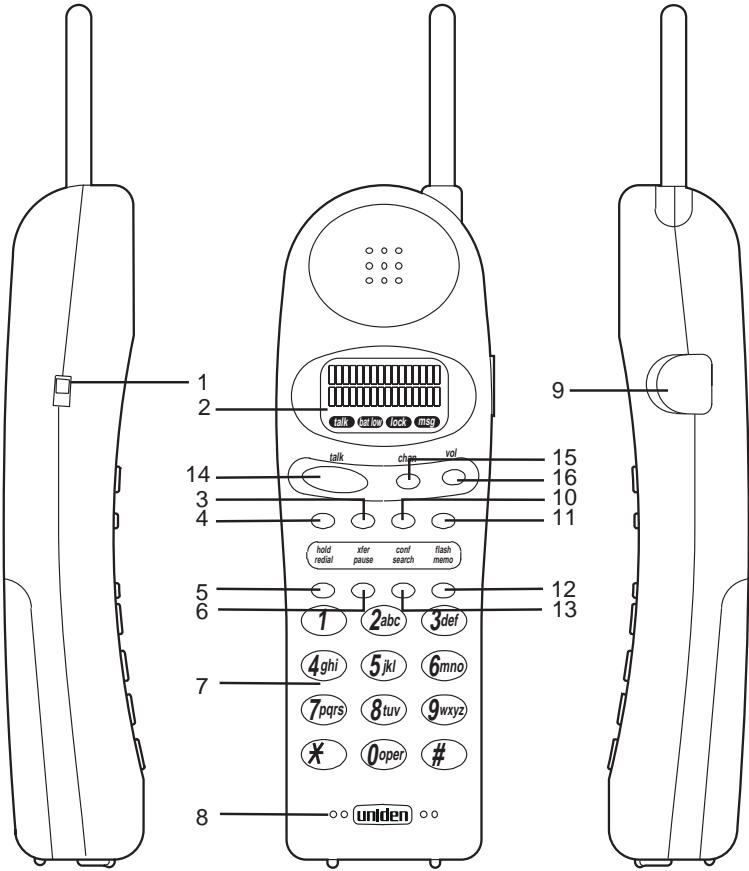

1. Ringer ON/OFF switch

2. Message Display

3. Transfer (*xfer*) Key

4. Hold (*hold*) Key

5. Redial (*redial*) Key

6. Pause (*pause*) Key

7. Numeric Keypad

8. Microphone

9. Head Set Jack

10. Conference (*conf*) Key

11. Flash (*flash*) Key

12. Memo (*memo*) Key

13. Search (*search*) Key

14. Talk (*talk*) Key

15. Channel/Lock (*chan*) Key

16. Volume (*vol*) Key

---

## Base Unit Controls & Functions

---

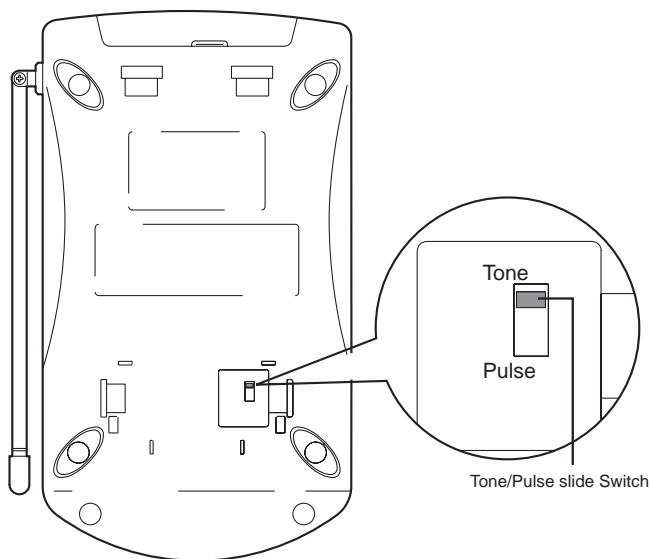
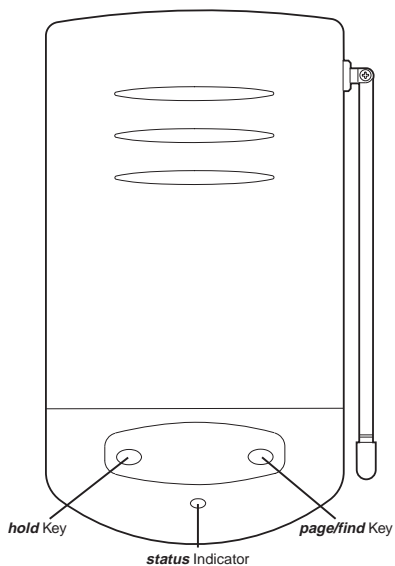

---

# TABLE OF CONTENTS

---

<b>Important Safety Instructions</b> .....	2
<b>About Your ANA 9610</b> .....	4
<b>Important Electrical Considerations</b> .....	5
Range .....	5
Telephone Line Problems .....	5
Radio Interference .....	6
More Than One Cordless Telephone .....	6
Privacy .....	6
<b>ANA 9610 Features</b> .....	7
<b>Installing Your ANA 9610</b> .....	8
Selecting the Installation Location .....	8
Connecting the Telephone Line .....	8
Connecting the Telephone Cords .....	9
Tone/Pulse Switch .....	10
Applying Power to the Base and Charger Units .....	10
Wall Installation .....	12
Attaching the Belt Clip to the Handset .....	17
Installing the Handset Battery Pack .....	18
Charging the Handset Battery Pack .....	19
Charging Spare Battery Packs .....	20
Low Battery Indicator .....	20
Cleaning the Battery and Charging Unit Contacts .....	21
<b>Using Your ANA 9610 Handset</b> .....	22
ANA 9610 Handset Controls .....	23
Using the Handset .....	24
Answering a Call .....	25
Making a Call .....	25
<b>Feature Buttons</b> .....	26
Placing a call "on hold" .....	26
Transferring a Call .....	26
Connecting a Conference Call .....	26
Programming the Feature Buttons .....	27
<b>Function Keys</b> .....	28
<b>Using Your ANA 9610 Memory</b> .....	29
Storing a Number .....	29
Erasing a Stored Number .....	30
Dialing with a Stored Number .....	31
Memory Search .....	31
Chain Dialing .....	32
<b>Using Your ANA 9610 Base Unit</b> .....	33
Using the Hold .....	33
Using the Page/Find .....	33
<b>Optional Head Set (EXP9530)</b> .....	34
<b>Optional Backup AC Adapter (EXP9505)</b> .....	35
<b>Using an Optional Second 2500-type Analog Telephone</b> .....	36
Connecting the Desk Telephone .....	36
Transferring a Call to the ANA 9610 .....	36
Transferring a Call to the Desk Telephone .....	36
<b>Optional Accessories and Replacement Parts</b> .....	38
<b>Troubleshooting</b> .....	39
<b>Specifications</b> .....	40

Uniden® is a registered trademark of Uniden America Corporation.

AutoStandby™ and AutoTalk™ are trademarks of Uniden America Corporation.

Downloaded from [www.uniden.com](http://www.uniden.com) on 08/11/13. All Rights Reserved. Search and Download.

---

## Important Safety Instructions

---

When using your telephone equipment, basic safety precautions should always be followed to reduce the risk of fire, electrical shock, and injury to persons, including the following:

1. Read and understand all instructions.
2. Follow all warnings and instructions marked on the product.
3. Unplug this product from the wall outlet before cleaning. **Do not** use liquid cleaners or aerosol cleaners. Use a dry cloth for cleaning.
4. **Do not** use this product near water; for example, near a sink or in a wet area.
5. **Do not** place this product on an unstable cart, stand, or table. The telephone may fall, causing serious damage to the unit.
6. To protect the product from overheating, do not block or cover any slots or openings in the base Unit. This product should never be placed near or over a radiator or heat register. This product should not be placed in a built-in installation unless proper ventilation is provided.
7. This product should be operated only from the type of power source indicated on the marking label.
8. **Do not** allow anything to rest on the power cord. Do not locate this product where the cord will be damaged by persons walking on it.
9. **Do not** overload wall outlets and extension cords, as this can result in the risk of fire or electrical shock.
10. Never push objects of any kind into this product through the Base Unit slots, as they may touch dangerous voltage points or short out parts that could result in a risk of fire or electric shock. Never spill liquid of any kind on the product.
11. To reduce the risk of electric shock, do not disassemble this product. Contact qualified service personnel when some service or repair work is required. Opening or removing covers may expose you to dangerous voltages or other risks. Incorrect reassembly can cause electric shock when the appliance is subsequently used.
12. Unplug this product from the wall outlet and refer servicing to qualified service personnel under the following conditions:
  - A. When the power supply cord is damaged or frayed.
  - B. If liquid has been spilled into the product.
  - C. If the product has been exposed to rain or water.



- D. If the product does not operate normally when following the operating instructions. Adjust only those controls that are covered by the operating instructions. Improper adjustment of other controls may result in damage, and will often require extensive work by a qualified technician to restore the product to normal operation.
  - E. If the product has been dropped, or the cabinet has been damaged.
  - F. If the product exhibits a distinct change in performance.
13. **Do not** use the telephone to report a gas leak in the vicinity of the leak.

***CAUTION: To reduce the risk of fire or injury to persons by the battery, read and follow these instructions:***

- 1. Use only the appropriate type and size Battery Pack specified in this Operating Guide.
- 2. **Do not** dispose of the Battery Pack in a fire. The cell may explode.
- 3. **Do not** open or mutilate the Battery Pack. Released electrolyte is corrosive and may cause damage to the eyes or skin. It may be toxic if swallowed.
- 4. Exercise care in handling the battery in order not to short the battery with conducting materials such as rings, bracelets, and keys. The battery or conductor may overheat and cause burns.
- 5. Charge the Battery Pack provided with or identified for use with this product only in accordance with the instructions and limitations specified in the instruction manual provided for this product.
- 6. Observe proper polarity orientation between the Battery Pack and battery charger.

**SAVE THESE INSTRUCTIONS**

---

## About Your ANA 9610

---

Congratulations on your purchase of the Uniden **ANA 9610** Cordless Telephone. The **ANA 9610** is designed and engineered to exacting standards for reliability, long life, and outstanding performance. It is designed to work with a PBX system. To get the most from your **ANA 9610**, please read this Operating Guide thoroughly. To help familiarize you with the features of your cordless phone, refer to the Handset illustration foldout from the front cover, and the Base Unit illustration foldout from the rear cover.

Your **ANA 9610** includes the following items:

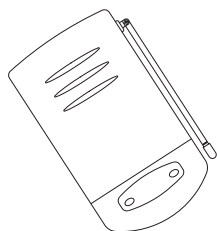

Base Unit



Handset

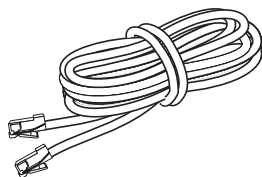

Telephone Cord

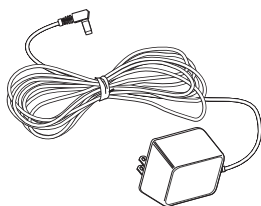

2 AC Adapters



2 Rechargeable Batteries

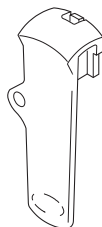

Belt Clip

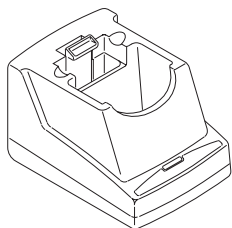

Charging Stand

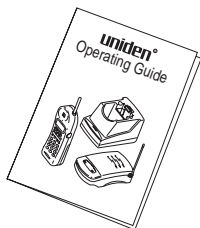

Operating Guide  
OMANA 9610

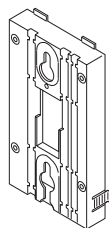

Wall Plate Adapter

If any of these items are missing or damaged, contact your PBX Administrator. If your **ANA 9610** is not performing to your expectations, please try the simple steps listed in the Trouble Shooting Section of this Guide. If you are still unable to resolve the problem, contact your PBX Administrator.

---

# Important Electrical Considerations

---

**Warning:** *Please do not attempt to unplug any appliance during an electrical storm.*

Unplug all electrical appliances when you know an electrical storm is approaching. Lightning can pass through your household wiring and damage any device connected to it. This phone is no exception.

**Caution:** *Changes or modifications to this product not expressly approved by Uniden, or operation of this product in any way other than as detailed by this Operating Guide, could void your authority to operate this product.*

## Range

Your new phone is designed to achieve the maximum possible range by transmitting and receiving according to the highest specifications set forth by the FCC and IC. We have rated this phone to operate at a maximum distance with the qualification that the range depends upon the environment in which the telephone is used. Many factors limit range, and it would be impossible to include all the variables in our rating. The Maximum Range rating of this phone is meant to be used as a means of comparison against other range claims.

## Telephone Line Problems

The FCC and IC have granted the telephone company the right to disconnect service in the event that your phone causes problems on the telephone line. Also, the telephone company may make changes in facilities and services which may affect the operation of your unit. However, your telephone company must give adequate notice in writing prior to such actions to allow you time for making necessary arrangements to continue uninterrupted service.

If you are having trouble with your telephone service, you must first disconnect your phone to determine if it is the cause of your problem. If you determine that it is the cause, you must leave it disconnected until the trouble has been corrected.

## Radio Interference

Radio interference may occasionally cause buzzing and humming in your cordless Handset, or clicking noises in the Base Unit. This interference is caused by external sources such as TV, refrigerator, vacuum cleaner, fluorescent lighting, computer equipment, or electrical storm. Your unit is NOT DEFECTIVE. If these noises continue and are too distracting, please check around your office to see what appliances may be causing the problem. In addition, we recommend that the Base not be plugged into a circuit that also powers a major appliance because of the potential for interference. Be certain that the antenna on the unit is fully extended when needed.

In the unlikely event that you consistently hear other voices or distracting transmissions on your phone, you may be receiving radio signals from another cordless telephone or other source of interference. If you cannot eliminate this type of interference, you need to change to a different channel.

Finally, it should be noted that some cordless telephones operate at frequencies that may cause interference to nearby TVs and VCRs. To minimize or prevent such interference, the base of the cordless telephone should not be placed near or on top of a TV or VCR. If interference is experienced, moving the cordless telephone farther away from the TV or VCR will often reduce or eliminate the interference.

## More Than One Cordless Telephone

If you want to use more than one cordless telephone in your office, they must operate on different channels. Press the channel key to select a channel that provides the clearest communication.

## Privacy

**Note:** Cordless phones are radio devices. Communications between the Handset and Base Unit of your cordless telephone are accomplished by means of radio waves which are broadcast over the open airways. Because of the inherent physical properties of radio waves, your communications can be received by radio receiving devices other than your own cordless telephone unit. Consequently, any communications using your cordless telephone may not be private.

---

## ANA 9610 Features

---

- Super Long Range 900MHz Digital
- 2-line, 16-digit LCD Display
- Headset Jack
- Ringer Volume Control
- Handset Volume Control
- Single button access to: CONFERENCE, HOLD, and TRANSFER features
- Four Function Keys: PAUSE, FLASH, REDIAL, SEARCH
- 20 Number Memory Store and Search
- Separate Charging Stand with Spare Battery Charging Capability
- Second Spare Battery
- AutoStandby
- AutoTalk
- Vibrator Ringer Alert
- Easy Installation
- Out of Range Protection
- Low Battery Protection System
- Key Pad Lock Feature
- Wall Mountable separate Base Unit
- Wall Mountable separate Charging Unit

---

# Installing Your ANA 9610

---

## Selecting the Installation Location

Select a location for the **ANA 9610** to avoid excessive heat or humidity. The Base Unit of your **ANA 9610** can be placed on a desk or tabletop near a standard 120V AC outlet and telephone line jack. The Base Unit can also be mounted on a **standard** AT&T or GTE wall plate using the optional Wall Mount Adapter. If you will use the **ANA 9610** with a Standard 2500 type Telephone Desk Unit, place the **ANA 9610** near that phone. Keep the Base Unit and Handset away from sources of electrical noise (motors, fluorescent lighting, computers).

## Connecting the Telephone Line

There are two types of phone outlets:

### 1) Modular Jack

Plug the telephone line cord from the Base Unit into a standard modular telephone jack. (Note: If you do not have a modular jack, contact your local telephone company for information on the installation of these jacks.)

### 2) Hard-wired Jack

A modular jack converter (not included) is required. You may need to rewire when connecting the converter (making color-coded connections).

*Note: Your Uniden Telephone Dealer or a telephone supply store can advise you on the proper adapter or converter.*

## Connecting the Telephone Cords

The **ANA 9610** must be connected to an analog PBX port or a standard analog telephone line.

### **CAUTION:**

- Never install telephone wiring during a lightning storm.
- Never touch uninsulated telephone wires or terminals unless the telephone line has been disconnected at the network interface.
- Use caution when installing or modifying telephone lines.

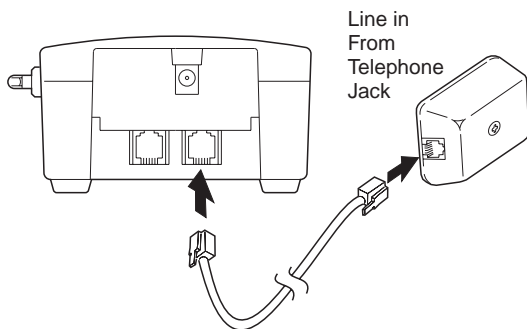

You can also connect a standard 2500-type desk phone to the **ANA 9610**:

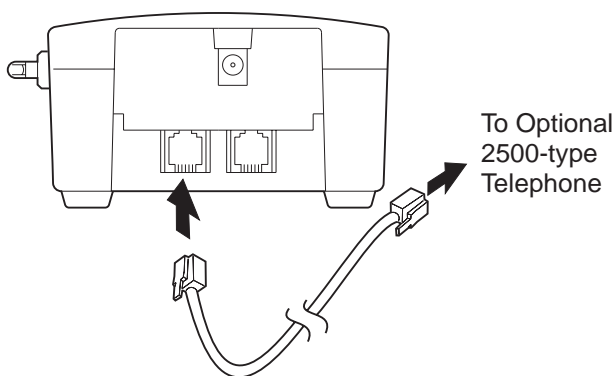

Connect to the LINE OUT Jack

## Tone/Pulse Switch

Be sure the TONE/PULSE switch is in the TONE position.

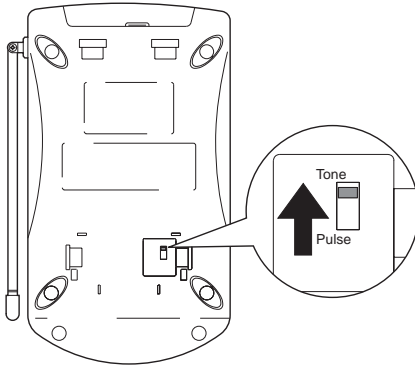

*Note: Most systems are Tone dialing. Check with your PBX Administrator if you are not sure whether your system is Tone or Pulse dialing.*

## Applying Power to the Base and Charger Units

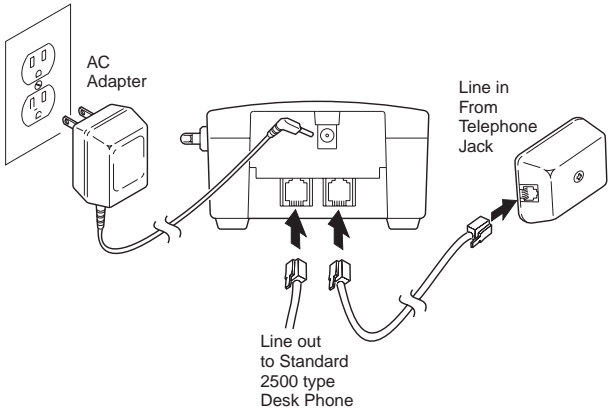

Use only the supplied AC Adapter: AD-9500



**IMPORTANT!** Route the power cord where it will not create a trip hazard, or where it could become chafed and create a fire or other electrical hazards.

*Note: The AC Adapter furnished with this phone may be equipped with a polarized line plug (a plug having one blade wider than the other.) This plug will fit into the power outlet only one way. If you are unable to insert the plug fully into the outlet, try reversing the plug.*

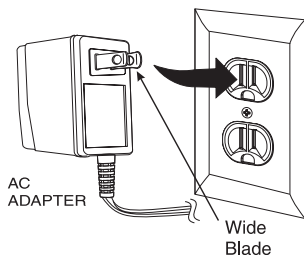

Do not alter the shape of the blades of the polarized plug.

*Note: If you cannot plug the AC Adapter into the outlet, contact someone about replacing the outlet.*

The unique design of your **ANA 9610** allows you to place the Handset in the Charging Unit with or without the Belt Clip attached. The Charging Unit also has the ability to charge a second battery with or without the Handset being charged. The Battery Packs can automatically be recharged either in or out of the Handset.

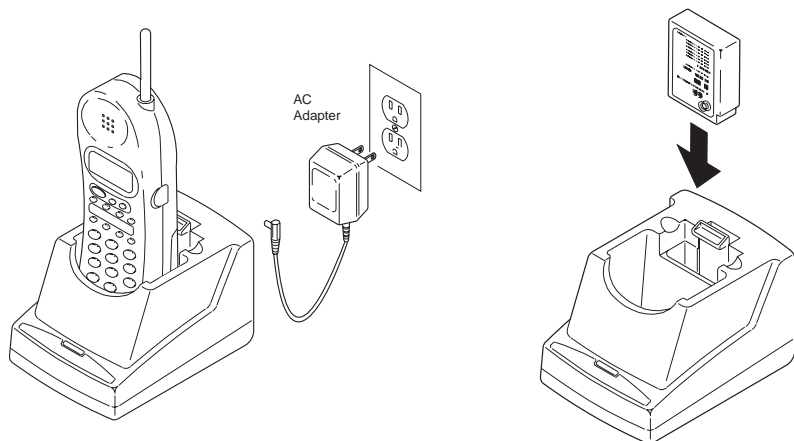

Use only the supplied AC Adapter: AD-960

# Wall Installation

## Standard Wall Plate Mounting

These Phones are designed to be mounted on a standard AT&T or GTE wall plate. To attach the wall mount stand to the Base Unit:

1. Slide the Wall Mount stand into the notches at the top of the Base Unit, rotate the Wall Mount stand down and snap it into place.

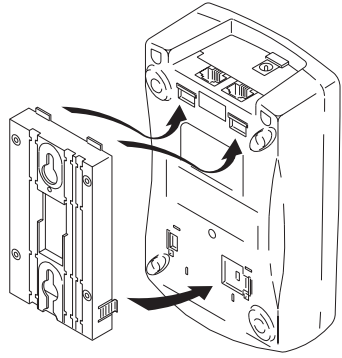

2. Plug the AC Adapter into the Base Unit as previously described.
3. Place the AC Adapter cord inside the molded channel of the Wall Mount stand.

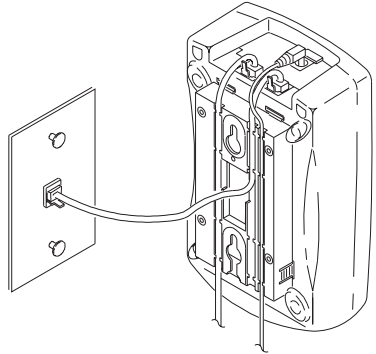

4. Plug one end of the short telephone cord into the **LINE** jack on the Base Unit. Optionally, plug one end of a standard 2500 type desk phone into the **PHONE** jack. Then place the telephone cord(s) inside the molded channel(s) on the bottom of the Wall Mount stand.
5. Plug the other end of the short telephone cord into the modular wall jack.

6. Place the Base Unit on the posts of the wall plate and push down until it's firmly seated.

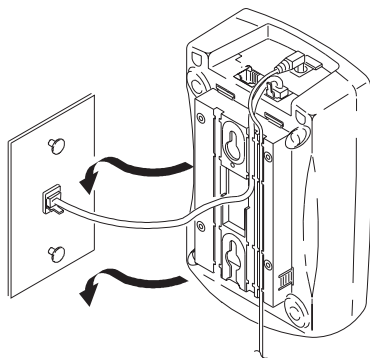

7. Plug the AC Adapter into a standard 120V AC wall outlet.

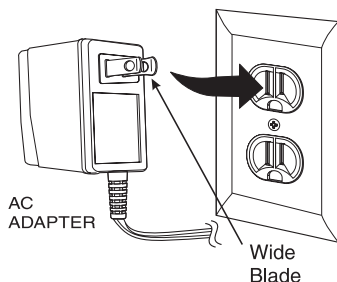

*Note: Do not use an outlet controlled by a wall switch.*

### Direct Wall Mounting

If you do not have a standard wall plate, you can mount your phone directly on a wall. Before mounting your phone, consider the following:

- Select a location away from electrical cables, pipes, or other items behind the mounting location that could cause a hazard when inserting screws into the wall.
- Make sure the wall material is capable of supporting the weight of the Base Unit.
- Use #10 screws with anchoring devices suitable for the wall material where the Base Unit will be placed.

1. Insert two mounting screws  $3 \frac{15}{16}$  inches apart. Allow about  $\frac{3}{16}$  of an inch between the wall and screw heads for mounting the phone.

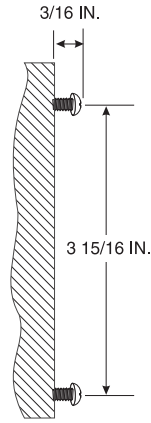

2. Plug and secure the AC Adapter cord by following steps 2 and 3 of the **Standard Wall Plate Mounting**.

3. Plug one end of the telephone line cord into the **LINE** jack on the Base Unit. Optionally, plug one end of a standard 2500 type desk phone into the **PHONE** jack. Then place the telephone cord(s) inside the molded channel(s) on the bottom of the Wall Mount stand.

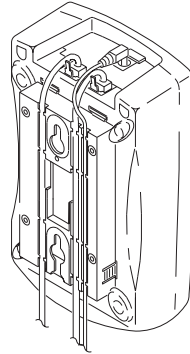

4. Place the Base Unit on the posts of the wall screws and push down until it's firmly seated.

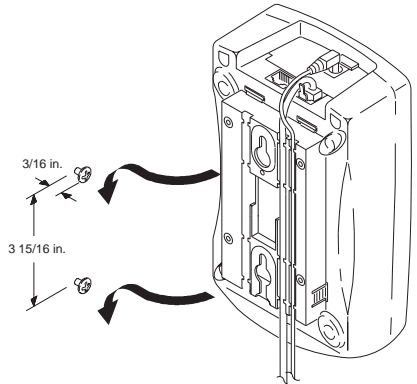

5. Plug the other end of the short telephone cord into a telephone wall jack.

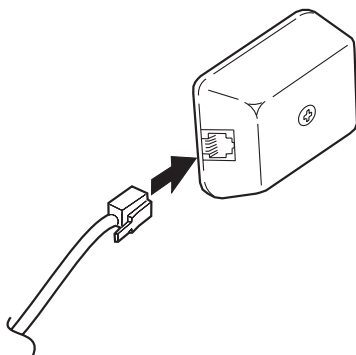

6. Plug the AC Adapter into a standard 120V AC wall outlet by following step 7 of the **Standard Wall Plate Mounting**.

### Charging Unit Wall Mounting

The Charging Unit is also designed to be wall mounted. you can mount your phone directly on a wall. Before mounting your charging unit, consider the following:

- Select a location away from electrical cables, pipes, or other items behind the mounting location that could cause a hazard when inserting screws into the wall.
- Make sure the wall material is capable of supporting the weight of the Charging Unit.
- Use #10 screws with anchoring devices suitable for the wall material where the Charging Unit will be placed.

1. Insert two mounting screws 1-1/2 inches apart. Allow about  $\frac{3}{16}$  of an inch between the wall and screw heads for mounting the phone.

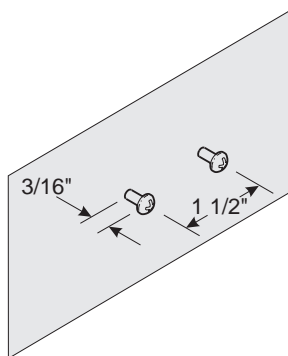

2. Plug the AC Adapter into the Charging Unit as previously described. Wrap the AC Adapter cord around the strain relief.

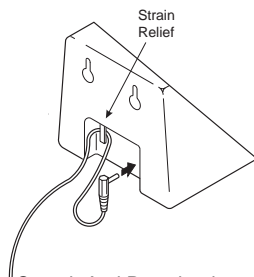

3. Place the Charging Unit on the posts of the wall screws and push down until it's firmly seated.

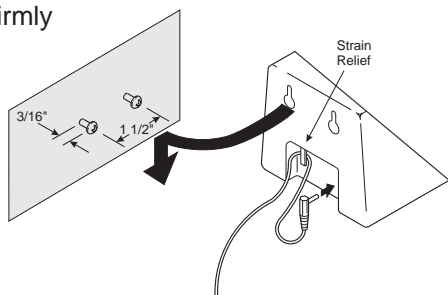

4. Plug the AC Adapter into a standard 120V AC wall outlet.

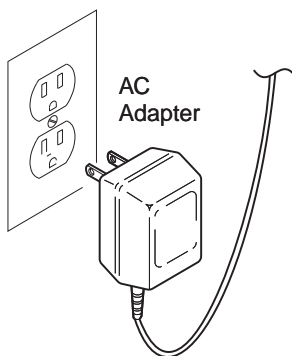

## Attaching the Belt Clip to the Handset

You can use the Belt Clip to attach the Handset to your belt or pocket for convenient portability.

1. Snap the tab out of the Belt Clip notch on the top of the Handset.

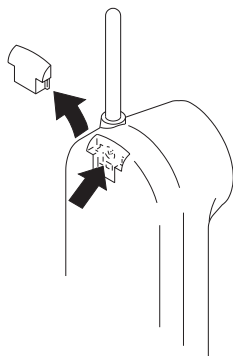

2. Slide the clip into the tab slot.

**(CAUTION:** The Belt Clip is designed to fit snugly onto the Handset.)

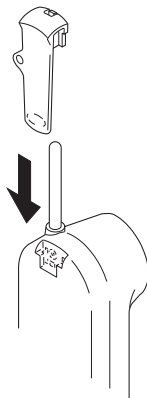

3. Press firmly until it snaps into place.

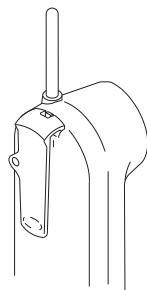

4. To remove, simply press the retain clip in toward the Belt Clip blade and slide the clip up at the same time. Once the Belt Clip is removed remember to re-install the cover tab.

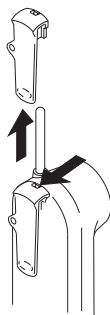

## Installing the Handset Battery Pack

1. Remove the battery cover by pressing the latch and sliding the cover down and off of the Handset.

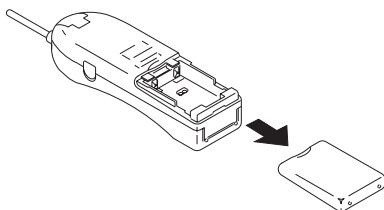

2. Slide the Battery Pack down into the Handset.

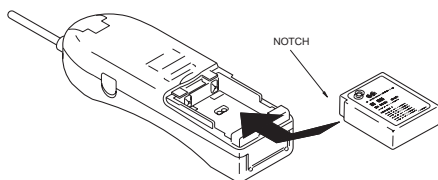

*Note: You may have to remove the old battery at this time.*



3. Place the cover and slide the cover up until it latches into the Handset.

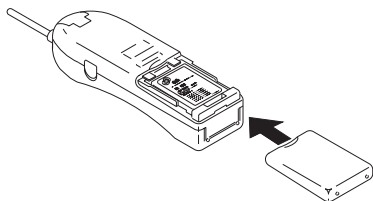

## Charging the Handset Battery Pack

The Rechargeable Sealed Lead-Acid Battery Pack must be fully charged before using your **ANA 9610** for the first time. (*Note: Charge the Battery Pack without interruption for 5 hours.*)

1. Place the Handset in the front slot of the Charging Unit.
2. Make sure the CHARGE 1 indicator lights. If the CHARGE 1 light doesn't light, check to see that the AC Adapter is plugged in, and that the Handset is making good contact with the Charging Unit charging contacts.

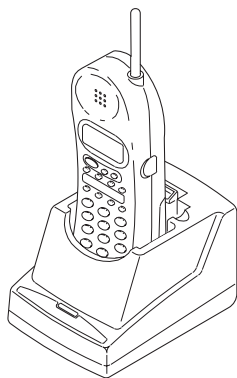

## Charging Spare Battery Packs

The Charger Unit of your **ANA 9610** is equipped to charge the Spare Battery Pack with or without the Handset in the front slot.

1. Slide the Spare Battery Pack into the second slot in the Charging Unit until the retaining clip snaps over the top of the pack.
2. Make sure the CHARGE 2 indicator lights. If the CHARGE 2 indicator doesn't light, check to see that the AC Adapter is plugged in, and that the Battery Pack is making good contact with the Charging Unit charging contacts.

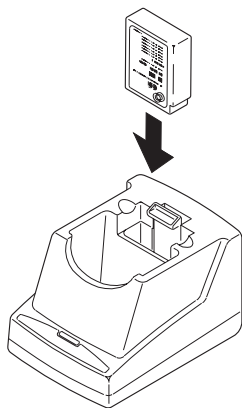

*Note: Charge the Battery Pack without interruption for 8 hours.*

3. When charging is complete, press out on the latch and remove the Battery Pack for use. Or, if you don't need the Battery pack immediately, leave it in the Charging Compartment; it will not overcharge.

## Low Battery Indicator

When the Battery Pack in the Handset is low and needs to be charged, you will see a message on the display.



On a Call	In Standby Mode
Only the <b>talk</b> button operates.	None of the buttons operate.
Handset beeps once every 3 seconds	Handset beeps every 15 seconds for 15 minutes.
Complete your call as quickly as possible	Cannot make call.
Replace Battery pack within 20 seconds to continue call.	Replace Battery Pack before making a call.

Return the Handset to the Charging Unit for charging or replace the Handset Battery Pack with another charged Battery Pack.

## Cleaning the Battery and Charging Unit Contacts

To maintain a good charge, it is important to clean all charging contacts on the Handset, Spare Battery Pack and Charging Unit about once a month. Use a pencil eraser or other contact cleaner. Do not use any liquids or solvents.

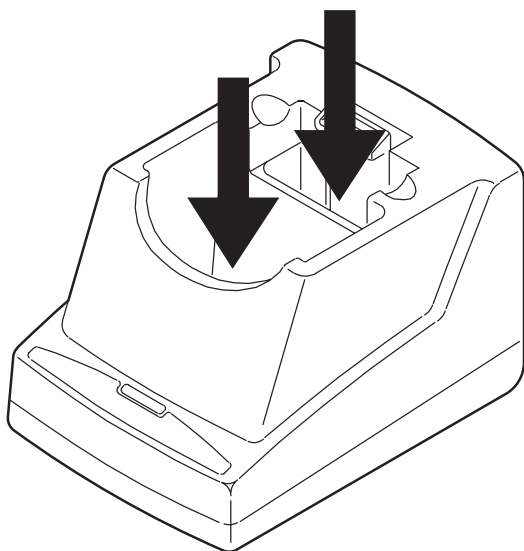

---

## Using Your ANA 9610 Handset

---

Before using your **ANA 9610**, be sure to raise the antenna to the vertical position.

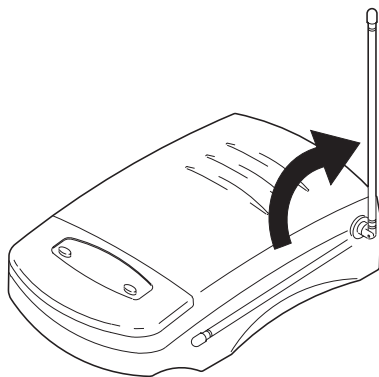

*Note:* Operation of the **ANA 9610** is performed using the Handset out of the Charging Unit.

# ANA 9610 Handset Controls

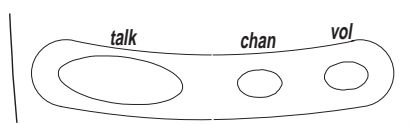

Condition	Action	LCD Display
Handset Earpiece Volume (During a Call)	Press <b>vol</b> on the front of the Handset to select a high or low Earpiece volume level.	No display indications.
Ringer Select (Standby Mode)	Press <b>vol</b> on the front of the Handset to select on of the following settings:  Ring type A (High)  Ring type A (Low)  Ring type B (High)  Ring type B (Low)  Ring Off (Vibrate)	<div style="border: 1px solid black; border-radius: 10px; padding: 5px; text-align: center; margin-bottom: 10px;"> <b>Ring Type A</b> High         </div> <div style="border: 1px solid black; border-radius: 10px; padding: 5px; text-align: center; margin-bottom: 10px;"> <b>Ring Type A</b> Low         </div> <div style="border: 1px solid black; border-radius: 10px; padding: 5px; text-align: center; margin-bottom: 10px;"> <b>Ring Type B</b> High         </div> <div style="border: 1px solid black; border-radius: 10px; padding: 5px; text-align: center; margin-bottom: 10px;"> <b>Ring Type B</b> Low         </div> <div style="border: 1px solid black; border-radius: 10px; padding: 5px; text-align: center;"> <b>Ring Off</b> </div>

## Using the Handset

When you pick up the Handset and press *talk*, you will see:

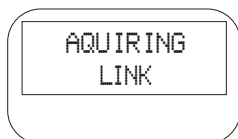

After the connection has been made between the Handset and Base, you will see:

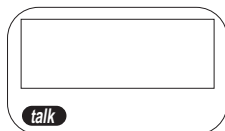

Or, you may see one of the following:

Condition	Indicator	LCD Screen
No Connection to Base Unit	Error Tone	
Channel Busy	Error Tone	CHANNEL BUSY
Line in Use	Error Tone	LINE IN USE

If the Handset is at the range limit of the **ANA 9610**, or no power is going to the Base Unit, you may see:

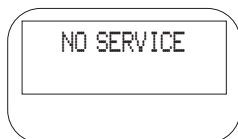

Take the following action:

	During a Call	In Standby Mode
<b>Condition</b>	Warning Tone	Can't make or answer calls (Phone may ring intermittently)
<b>Action</b>	Move back in range within 20 seconds or check power to the Base Unit.	Move back within range or check power to the Base Unit.

## Answering a Call

When you receive a call, the Handset rings and you'll see:

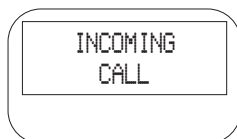

Handset in the Charging Unit	Handset out of Charging Unit
Pick up the Handset. The AutoTalk feature allows you to answer the call immediately.	Press <i>talk</i>
When you finish the call, place the Handset back in the Charging Unit. AutoStandby automatically hangs up the phone.	
—OR—	
Press <i>talk</i> to hang up the phone	

## Making a Call

Press *talk*. The *talk* Icon will illuminate after the Handset/Base are connected, and you'll see:



When you hear a dial tone, enter the number you are calling. (You can also dial from memory. See the section on "Using Memory.")



When you finish the call, press the *talk* button again, this will hang up the phone and put it in AutoStandby.

---

## Feature Buttons

---

*Note: The exact operation of the Feature Buttons depends on how your PBX system is configured. Contact your PBX Administrator for more information.*

### Placing a call “on hold”

Press **hold**. You’ll hear a “beep” and see:



To resume the call, press **hold** or **talk**.

### Transferring a Call

Press **xfer** (TRANSFER). You’ll hear a “beep”, and see:

Dial the target number.



When the receiving party answers, press **xfer** to complete the transfer.

### Connecting a Conference Call

To connect a second party to a call in progress, press **conf** (CONFERENCE). You’ll hear a “beep,” and see:



Dial the second party’s number.



When the other party answers, press **conf** to have a three-way conversation.



## Programming the Feature Buttons

The Transfer and Conference Keys can be programmed for special use, such as causing a “Hook Flash” followed by a special number or function.

For example — to program the **xfer** key for “Hook Flash” and 9 for outside transfers only:

Press **memo**.

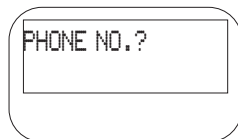

Press **flash**.

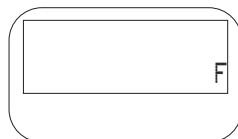

Press **9**.

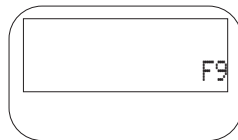

Press **memo**.

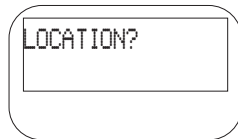

Press **xfer**.

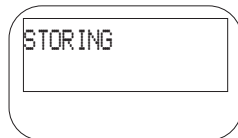

**Note:** For the **ANA 9610**, conference and transfer keys are operated by the Flash Hook function. Please, program your system transfer or conference code with the assistance of the PBX System Administrator.

---

## Function Keys

---

### HOLD

Press once, you'll hear a "beep" and the call is placed on hold.  
Press **hold** or **talk** to resume the call (local hold).

### XFER

Press **xfer** (Transfer), you'll hear a "beep".  
Dial the target number.  
When the receiving party answers, press **xfer** to complete call.

### CONF

To connect a second party to a call in progress, press **conf** (CONFERENCE). You'll hear a "beep".  
Dial the second party's number.  
When the other party answers, press **conf** to have a three-way conversation.

### FLASH

Press once to cause a "Hook Flash" while on a call.  
Press once to program a "Hook Flash" in a Feature Button.

### REDIAL

To dial the last number called, press **talk**, then **redial**. The phone will redial the last number called.

### PAUSE

Press once to program a Pause while storing a number in Memory.

### SEARCH

Press to begin Memory Search. (See the following Section for Memory Search.)

### MEMO

Press **memo**.  
Press desired function.  
Press memory location (1-20).  
Press **memo**, then **xfer**.

## Using Your ANA 9610 Memory

Use these buttons to operate the ANA 9610 Memory

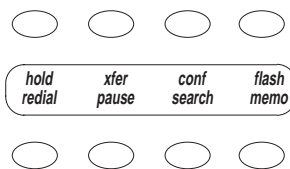

### Storing a Number

1. Press **memo**. You will hear a beep, and see the message:

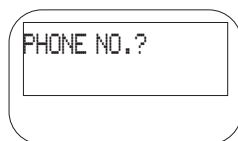

2. Enter the number (up to 16 digits) you want to store.

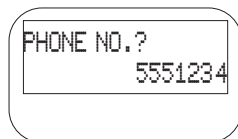

- a. To program a Pause in the dialing sequence, press **pause**.

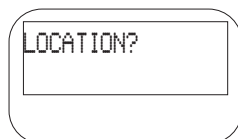

3. Press **memo**. You will see the message:

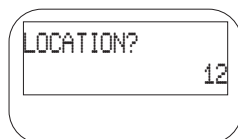

4. Enter the number (01) -(20) for the memory location to store. You'll hear a confirmation beep and see the message:

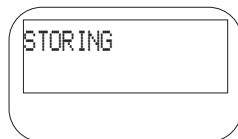

*Note: After pressing **memo** the second time, you have 20 seconds to enter the memory location. Otherwise, an error tone sounds and the unit returns to Standby.*

5. The ANA 9610 then returns to Standby mode.

**Example: Store 555-1234 in memory location 12:**

- a. Press **memo**.

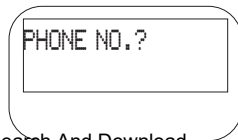

b. Enter **5551234**.

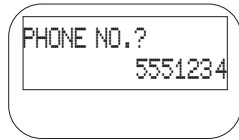

c. Press **memo**.

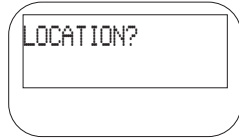

d. Press **12**.

The Handset beeps. This is confirmation that you have programmed 5551234 into memory location 12 and you see:

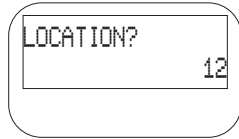

The phone then returns to Standby.

## Erasing a Stored Number

1. Press **memo**.

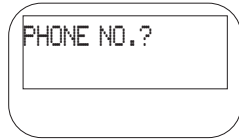

2. Press **memo**.

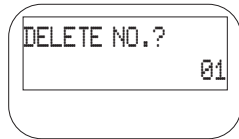

3. Enter the memory location number (01) to (20) you want to clear. You will hear a long beep and see:

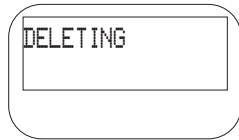

## Dialing with a Stored Number

*Note: The following applies when the phone is in Standby Mode, and you have already established a connection between Handset and Base Unit.*

1. Press **talk**.
2. Press **memo**.
3. Enter the Memory Location (01 - 20).



The phone automatically dials the number shown.

## Memory Search

You can search all 20 Memory Locations to find the number you need. Once you have found the number, you can automatically dial that number by pressing the **talk** key.

1. Press **search**. Search automatically starts at memory Location 01.

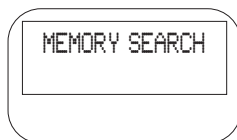

(If Memory Location 01 doesn't have a stored number, search will display the first stored number.)

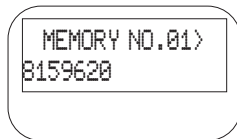

3. a. Press **vol** again to move to the next used Programed Memory Location.  
b. You can also press **chan** to move to a previous used Memory Location.

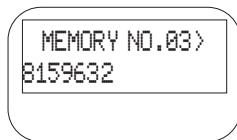

- c. Pressing the **chan** key, you will move down through the Memory (20 to 1). Pressing **vol** you will move up through the Memory (1 to 20). Press **vol** or **chan** until you reach the desired Memory Location.

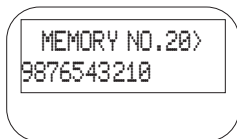

4. Once you have the desired number, press **talk**. The **talk** icon appears.



The phone will then automatically dial the number.

## Chain Dialing

You can dial any stored number while you are on a call. This is sometimes needed for Long Distance Access Codes or Account Access Numbers.

1. While you are on the call, press **search**.
2. Press **vol** or **chan** as needed to locate the number in Memory.
3. Once you have the desired number, press **talk**. The phone dials the number.

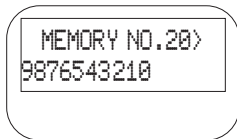
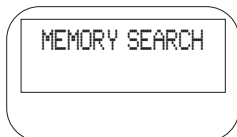

---

## Using Your ANA 9610 Base Unit

---

Although most of the **ANA 9610** operations are performed at the Handset, there are two operations performed at the Base Unit.

The **status** LED (2) blinks whenever the Handset is connected to a call.

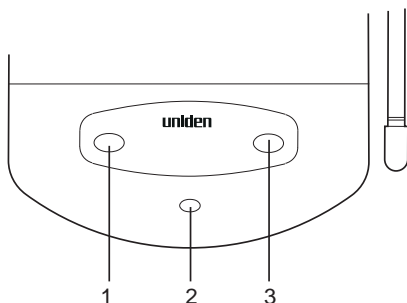

### Using the Hold

The **hold** button (1) is used in conjunction with a desk top phone to switch from the Handset to a desk top phone.

1. If you need to use a desk top phone which the **ANA 9610** is connected to, press **hold** on the Base unit then pick up the desk top phone.
2. To resume using the Handset, press **hold** on the Base unit, then press **talk** on the Handset. The Handset resumes functioning as before.

### Using the Page/Find

The **page/find** button (3) is used to locate the Handset. Pressing **page/find** will send a ring signal to the Handset.

**Note:** *The Handset Ringer must be on and set to Type A or B in order for the **page/find** function to work.*

---

## Optional Head Set (EXP9530)

---

The optional Head Set provides a “Hands-Free” Option for the **ANA 9610**. With the Head Set installed, you can use the Belt Clip to carry the Handset, and conduct a conversation using the Head Set.

To install the optional Head Set, open the cover over the HEADSET Jack and plug the Head Set in.

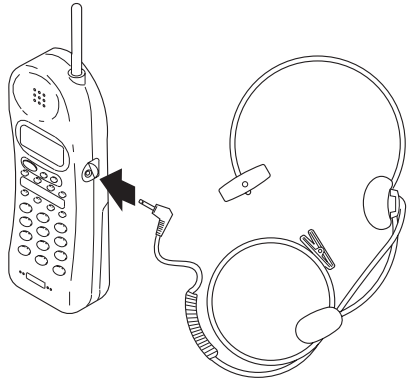

No other settings are needed.

Operation of the **ANA 9610** using the Head Set is exactly the same as using the Handset. However, you will hear through the Head Set earphone, and talk through the Head Set microphone. The Handset earphone and microphone (mouthpiece) are disconnected.



---

## Optional Backup AC Adapter (EXP9505)

---

The Optional Backup AC Adapter provides protection against losing a call in case of AC Power failure. The Backup Adapter contains a Battery Pack that provides enough power for you to complete the call and hang up.

To install the Backup Adapter:

1. Disconnect the Standard AC Adapter from the Base Unit of the **ANA 9610**.
2. Plug the AC Adapter into the jack of the EXP9505.
3. Plug the wire from the EXP9505 into the DC IN jack of the Base Unit.

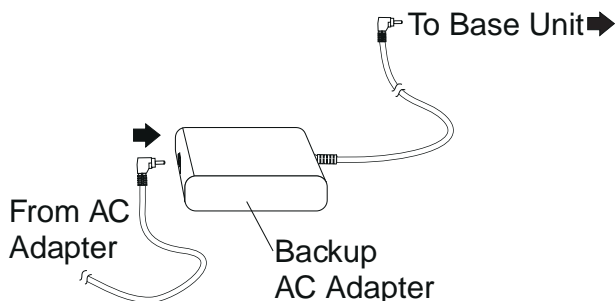

---

## Using an Optional Second 2500-type Analog Telephone

---

### Analog Telephone.

A standard 2500-type Desk telephone can be used with the **ANA 9610**. Calls can then be answered with the Desk phone and transferred to the **ANA 9610**.

***Note:** A special Security Feature disconnects the Desk phone whenever the **ANA 9610** Handset is in use.*

### Connecting the Desk Telephone.

Connect a telephone cord from the Desk phone to the LINE OUT jack on the **ANA 9610** Base Unit.

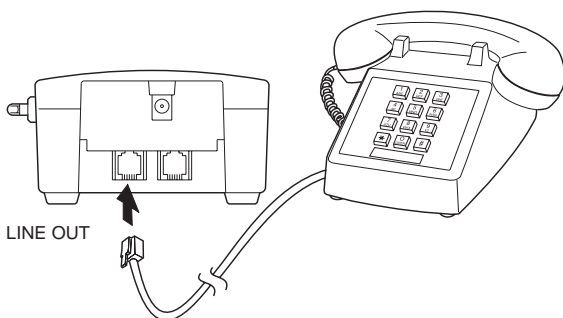

The Desk phone can now be used to answer or place calls in the normal manner.

### Transferring a Call to the **ANA 9610**.

1. Press **hold** on the Base unit, hang up the desk phone and press **talk** on the Handset.

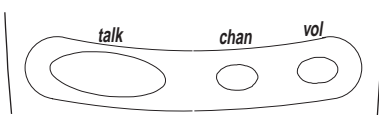

The call is now transferred to the **ANA 9610**, and the Desk phone is disconnected.

### Transferring a Call to the Desk Telephone

1. Press **hold** on the **ANA 9610** Base Unit.
2. Pick up the the Desk phone and press **talk** on the Handset.

The **ANA 9610** Handset disconnects.

---

## Typical Applications

---

You can use the **ANA 9610** together with a standard PBX telephone to give you effective business communications both at your desk and away from it. Contact your PBX Administrator for more information about your System.

You can have your PBX system programmed so the following sequence occurs:

1. Your PBX telephone rings first.
2. If you don't answer the PBX telephone after a set number of rings, the call is automatically transferred to the **ANA 9610**.
3. If you don't answer the call after a set number of rings, it is automatically transferred to your Voice Mail.

**Note:** *It is good practice to keep the number of rings in each case to 2 or 3. This gives you a chance to answer the call, and doesn't keep the other party waiting too long.*

---

## Optional Accessories and Replacement Parts

---

For the following Optional Accessories and Replacement Parts contact your PBX Administrator.

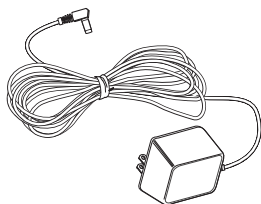

AC Adapter

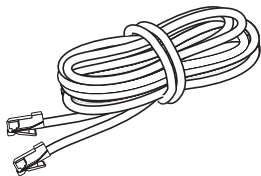

Telephone Cord

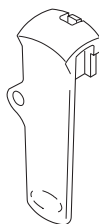

Belt Clip  
EXP9602

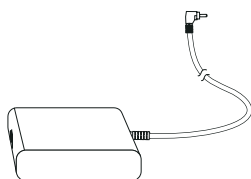

Backup AC Adapter  
EXP9505



500 mAh Battery  
BT-9000

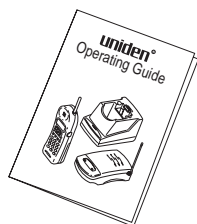

Operating Guide  
OMANA 9610

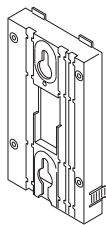

Base Unit Wall Mount  
EXP9660



Head Set  
EXP9530

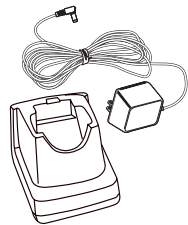

Charger and AC  
Adapter EXP9685

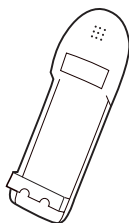

Leather Case  
EXP9683

---

## Troubleshooting

---

If your **ANA 9610** Cordless Telephone is not performing to your expectations, please try these simple steps. If you are still unable to resolve the problems, contact your PBX Administrator.

**Note:** *Do not attempt to service this unit yourself. All service must be done by qualified service personnel.*

<b>Problem</b>	<b>Suggestion</b>
Charge light won't come on when Handset is placed in Charging Unit.	<ul style="list-style-type: none"><li>• Make sure the AC Adapter is plugged into the Base Unit and wall outlet.</li><li>• Make sure Handset is properly seated in Charging Unit.</li><li>• Make sure the Sealed Lead-Acid Battery Pack is properly placed on the Handset.</li><li>• Make sure that the charging contacts on the Handset and Charging Unit are clean.</li></ul>
Conversation interrupted frequently.	<ul style="list-style-type: none"><li>• Make sure that the Base Unit antenna is fully vertical.</li><li>• Move closer to the Base Unit.</li><li>• Check for LOW BAT warning.</li></ul>
Warning tone and NO SERVICE message.	<ul style="list-style-type: none"><li>• Move closer to the Base Unit.</li></ul>
Handset doesn't ring.	<ul style="list-style-type: none"><li>• Sealed Lead-Acid Battery may be weak. Charge the Battery Pack for 5-6 hours.</li><li>• Make sure the Base Unit antenna is fully vertical.</li><li>• The Handset may be too far away from the Base Unit.</li><li>• Ensure the Ringer ON/OFF switch is in the ON Position.</li></ul>

---

## Specifications

---

**General:** The ANA 9610 complies with FCC and IC parts 15 and 68.

Frequency Control : Phase Lock Loop

Modulation : FM

Operating Temperature : -10° to 50° C

### Base Unit

Receive/Transmit Frequency: 902 MHz to 928 MHz

Power Requirements : 10V DC from supplied AC Adapter

Size : 4 1/4 in. W x 7 1/2 in. D x 2 1/4 in. H

Weight : Approx. 15.4 oz.

### Handset

Receive/Transmit Frequency: 902 MHz to 928 MHz

Power Requirements : Rechargeable Sealed Lead Acid  
Battery Pack

Size : 2 1/4 in. W x 1 1/2 in. D x 8 1/2 in.  
H  
with antenna

Weight : Approx. 8.8 oz. with battery

Battery : Capacity 500 mAH, 4.0V

Talk Mode : 5 hours (typical)

Standby Mode : 40 hours (typical)

Specifications shown are typical and subject to change without notice.

## Free Manuals Download Website

<http://myh66.com>

<http://usermanuals.us>

<http://www.somanuals.com>

<http://www.4manuals.cc>

<http://www.manual-lib.com>

<http://www.404manual.com>

<http://www.luxmanual.com>

<http://aubethermostatmanual.com>

Golf course search by state

<http://golfingnear.com>

Email search by domain

<http://emailbydomain.com>

Auto manuals search

<http://auto.somanuals.com>

TV manuals search

<http://tv.somanuals.com>