

uniden®

ANA 9710 900 MHz Analog PBX Cordless Telephone

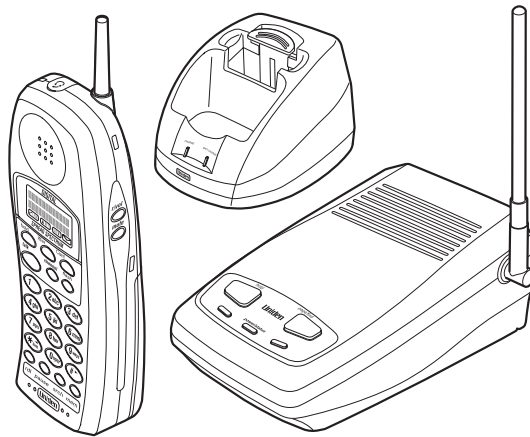

Operating Guide

One Year Limited Warranty

WARRANTOR: UNIDEN AMERICA CORPORATION ("Uniden")

ELEMENTS OF WARRANTY: Uniden warrants, for one year, to the original retail owner, this Uniden Product to be free from defects in materials and craftsmanship with only the limitations or exclusions set out below.

WARRANTY DURATION: This warranty to the original user shall terminate and be of no further effect 12 months after the date of original retail sale. The warranty is invalid if the Product is (A) damaged or not maintained as reasonable or necessary, (B) modified, altered, or used as part of any conversion kits, subassemblies, or any configurations not sold by Uniden, (C) improperly installed, (D) serviced or repaired by someone other than an authorized Uniden service center for a defect or malfunction covered by this warranty, (E) used in any conjunction with equipment or parts or as part of any system not manufactured by Uniden, or (F) installed or programmed by anyone other than as detailed by the Operating Guide for this product.

STATEMENT OF REMEDY: In the event that the product does not conform to this warranty at any time while this warranty is in effect, warrantor will repair the defect and return it to you without charge for parts, service, or any other cost (except shipping and handling) incurred by warrantor or its representatives in connection with the performance of this warranty. THE LIMITED WARRANTY SET FORTH ABOVE IS THE SOLE AND ENTIRE WARRANTY PERTAINING TO THE PRODUCT AND IS IN LIEU OF AND EXCLUDES ALL OTHER WARRANTIES OF ANY NATURE WHATSOEVER, WHETHER EXPRESS, IMPLIED OR ARISING BY OPERATION OF LAW, INCLUDING, BUT NOT LIMITED TO ANY IMPLIED WARRANTIES OF MERCHANTABILITY OR FITNESS FOR A PARTICULAR PURPOSE. THIS WARRANTY DOES NOT COVER OR PROVIDE FOR THE REIMBURSEMENT OR PAYMENT OF INCIDENTAL OR CONSEQUENTIAL DAMAGES. Some states do not allow this exclusion or limitation of incidental or consequential damages so the above limitation or exclusion may not apply to you.

LEGAL REMEDIES: This warranty gives you specific legal rights, and you may also have other rights which vary from state to state. This warranty is void outside the United States of America.

PROCEDURE FOR OBTAINING PERFORMANCE OF WARRANTY: If, after following the instructions in this Operating Guide you are certain that the Product is defective, pack the Product carefully (preferably in its original packaging). Include evidence of original purchase and a note describing the defect that has caused you to return it. The Product should be shipped freight prepaid by traceable means, or delivered, to warrantor at:

Uniden America Corporation
BCS-Repair
4700 Amon Carter Blvd.
Fort Worth, TX 76155
800-554-3988, 7 a.m. to 5 p.m. Central,
Monday through Friday
www.uniden.com

Covered under one or more of the following U.S. patents:

4,511,761	4,523,058	4,595,795,	4,597,104
4,797,916	4,803,491	5,381,460	5,426,690
5,434,905	5,491,745	5,533,010	5,574,727
5,650,790	5,660,269	5,661,780	5,663,981
5,671,248	5,717,312	5,754,407	5,787,356
5,794,152	5,838,721		

and other patents pending.

Uniden®

OMANA9710

©2001 Uniden America Corporation. Printed in U.S.A.

All rights reserved.

UCZZ01717BZ

PRECAUTIONS

Before you read anything else,
please observe the following:

WARNING!

Uniden America Corporation **DOES NOT** represent this unit to be waterproof. To reduce the risk of fire, electrical shock, or damage to the unit, **DO NOT** expose this unit to rain or moisture.

BATTERY WARNING

- This equipment contains a Rechargeable Nickel-Cadmium Battery.
- **Do not** short circuit the battery.
- **Do not** charge the Rechargeable Nickel-Cadmium Battery used in this equipment in any charger other than the one designed to charge this battery as specified in this Guide. Using another charger may damage the battery, or cause the battery to explode.
- **Do not** remove or damage the battery casing.
- Never throw the battery into a fire, disassemble it, or heat it.

RECYCLING NICKEL-CADMIUM BATTERIES

NICKEL-CADMIUM BATTERIES
MUST BE DISPOSED OF
PROPERLY.

Nickel-Cadmium cells are used in the battery pack.
Please take your battery packs to a store that recycles
Nickel-Cadmium batteries.

Handset Controls & Functions

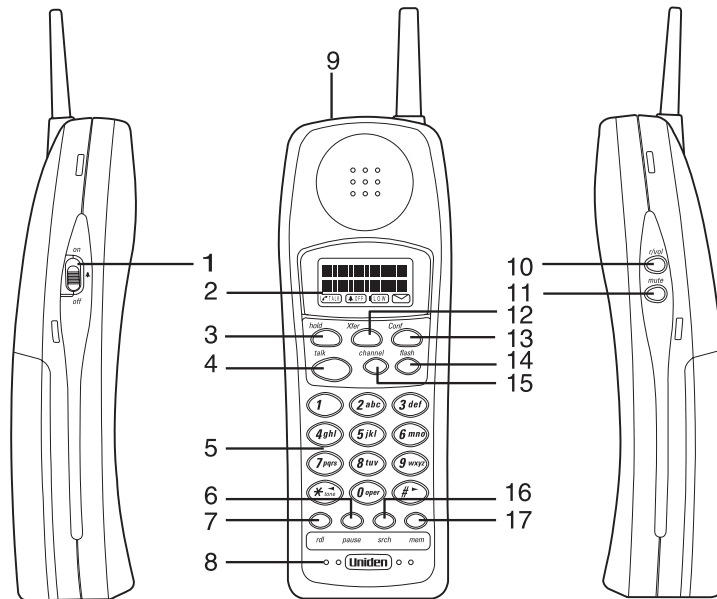

- | | |
|-------------------------------|------------------------------------|
| 1. Ringer ON/OFF switch | 10. Volume (r/vol) Key |
| 2. Message Display | 11. Mute (mute) Key |
| 3. Hold (hold) Key | 12. Transfer (xfer) Key |
| 4. Talk (talk) Key | 13. Conference (conf) Key |
| 5. Numeric Keypad | 14. Flash (flash) Key |
| 6. Pause (pause) Key | 15. Channel Key |
| 7. Redial (rdl) Key | 16. Search (srch) Key |
| 8. Microphone | 17. Memo (mem) Key |
| 9. Head Set Jack | |

Base Unit Controls & Functions

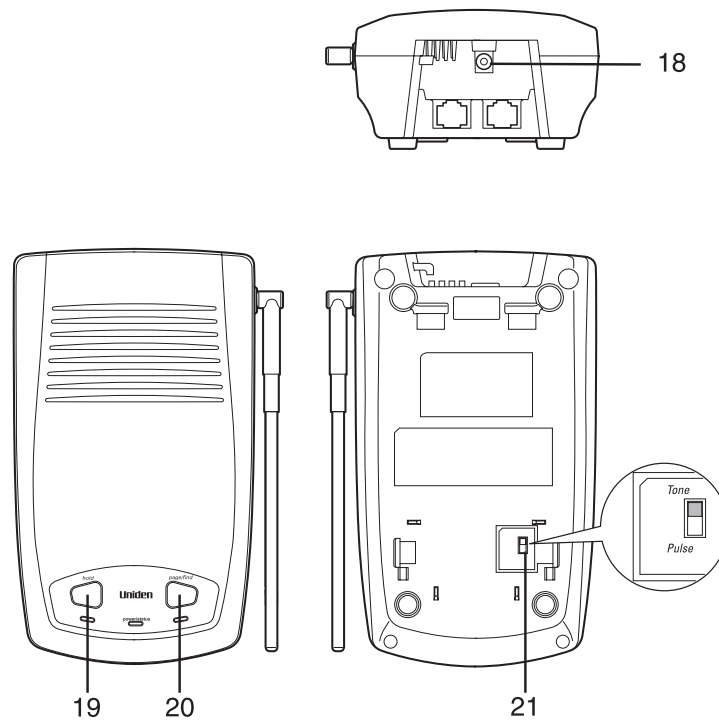

- 18. DC Power Jack
- 19. Hold (**hold**) Key
- 20. Page/find (**page/find**) Key
- 21. Tone/Pulse Switch

TABLE OF CONTENTS

Important Safety Instructions	2
About Your ANA 9710	4
Important Electrical Considerations	5
Range	5
Telephone Line Problems	5
Radio Interference	6
More Than One Cordless Telephone	6
Privacy	6
ANA 9710 Features	7
Installing Your ANA 9710	8
Selecting the Installation Location	8
Connecting the Telephone Line	8
Connecting the Telephone Cords	9
Tone/Pulse Switch	10
Applying Power to the Base and Charger Units	10
Wall Installation	12
Attaching the Beltclip to the Handset	17
Installing the Handset Battery Pack	18
Charging the Handset Battery Pack	19
Charging Spare Battery Packs	20
Low Battery Indicator	20
Cleaning the Battery and Charging Unit Contacts	21
Using Your ANA 9710 Handset	21
ANA 9710 Handset Controls	22
Using the Handset	24
Answering a Call	25
Making a Call	25
Feature Buttons	26
Placing a call "on hold"	26
Transferring a Call	26
Connecting a Conference Call	26
Programming the Feature Buttons	27
Function Keys	28
Using Your ANA 9710 Memory	29
Storing a Number	29
Erasing a Stored Number	30
Dialing with a Stored Number	31
Memory Search	31
Chain Dialing	32
Using Your ANA 9710 Base Unit	33
Using the Hold	33
Using the Page/Find	33
Optional Headset (EXP9530)	34
Using an Optional Second 2500-type Analog Telephone	35
Connecting the Desk Telephone	35
Transferring a Call to the ANA 9710	35
Transferring a Call to the Desk Telephone	35
Typical Applications	36
Optional Accessories and Replacement Parts	37
Troubleshooting	38
Specifications	39

Uniden® is a registered trademark of Uniden America Corporation.
AutoStandby™ and AutoTalk™ are trademarks of Uniden America Corporation.
AutoStandby is a patented invention of Uniden America Corporation.

Important Safety Instructions

When using your telephone equipment, basic safety precautions should always be followed to reduce the risk of fire, electrical shock, and injury to persons, including the following:

1. Read and understand all instructions.
2. Follow all warnings and instructions marked on the product.
3. Unplug this product from the wall outlet before cleaning. **Do not** use liquid cleaners or aerosol cleaners. Use a dry cloth for cleaning.
4. **Do not** use this product near water; for example, near a sink or in a wet area.
5. **Do not** place this product on an unstable cart, stand, or table. The telephone may fall, causing serious damage to the unit.
6. To protect the product from overheating, do not block or cover any slots or openings in the base Unit. This product should never be placed near or over a radiator or heat register. This product should not be placed in a built-in installation unless proper ventilation is provided.
7. This product should be operated only from the type of power source indicated on the marking label.
8. **Do not** allow anything to rest on the power cord. Do not place this product where the cord will be damaged by persons walking on it.
9. **Do not** overload wall outlets and extension cords, as this can result in the risk of fire or electrical shock.
10. Never put objects of any kind into this product through the Base Unit slots, as they may touch dangerous voltage points or short out parts that could result in a risk of fire or electric shock. Never spill liquid of any kind on the product.
11. To reduce the risk of electric shock, do not disassemble this product. Contact qualified service personnel when service or repair work is required. Opening or removing covers may expose you to dangerous voltages or other risks. Incorrect reassembly can cause electric shock when the appliance is subsequently used.
12. Unplug this product from the wall outlet and refer servicing to qualified service personnel under the following conditions:
 - A. When the power supply cord is damaged or frayed.
 - B. If liquid has been spilled on the product.
 - C. If the product has been exposed to rain or water.

- D. If the product does not operate normally when following the operating instructions. Adjust only those controls that are covered by the operating instructions. Improper adjustment of other controls may result in damage, and will often require extensive work by a qualified technician to restore the product to normal operation.
 - E. If the product has been dropped, or the cabinet has been damaged.
 - F. If the product exhibits a distinct change in performance.
13. **Do not** use the telephone to report a gas leak in the vicinity of the leak.

CAUTION: To reduce the risk of fire or injury to persons by the battery, read and follow these instructions:

1. Use only the appropriate type and size Battery Pack specified in this Operating Guide.
2. **Do not** dispose of the Battery Pack in a fire. The cell may explode.
3. **Do not** open or mutilate the Battery Pack. Released electrolyte is corrosive and may cause damage to the eyes or skin. It may be toxic if swallowed.
4. Exercise care in handling the battery in order not to short the battery with conducting materials such as rings, bracelets, and keys. The battery or conductor may overheat and cause burns.
5. Charge the Battery Pack provided with or identified for use with this product only in accordance with the instructions and limitations specified in the instruction manual provided for this product.
6. Observe proper polarity orientation between the Battery Pack and battery charger.

SAVE THESE INSTRUCTIONS

About Your ANA 9710

Congratulations on your purchase of the Uniden **ANA 9710** Cordless Telephone. The **ANA 9710** is designed and engineered to exacting standards for reliability, long life, and outstanding performance. It is designed to work with a PBX system. To get the most from your **ANA 9710**, please read this Operating Guide thoroughly. To help familiarize you with the features of your cordless phone, refer to the Handset and Base Unit illustration foldout from the front cover.

Your **ANA 9710** includes the following items:

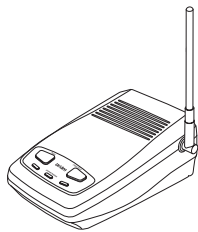

Base Unit



Handset

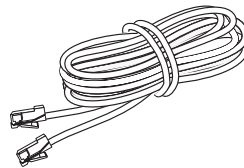

Telephone Cord

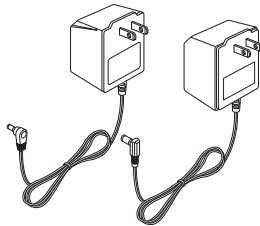

2 AC Adapters

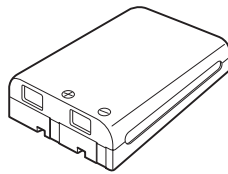

Rechargeable
Battery (BT2499)

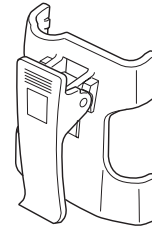

Beltclip (EXP9702)

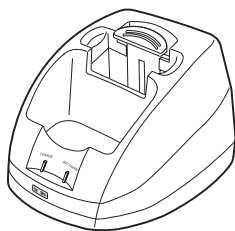

Charging Stand

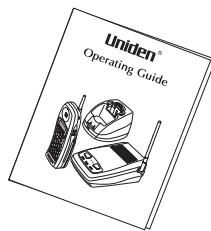

Operating Guide
OMANA 9710

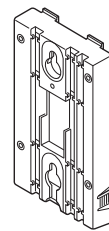

Wall Plate Adapter

If any of these items are missing or damaged, contact your PBX Administrator. If your **ANA 9710** is not performing to your expectations, please try the simple steps listed in the Troubleshooting Section of this Guide. If you are still unable to resolve the problem, contact your PBX Administrator.

Important Electrical Considerations

Warning: *Please do not attempt to unplug any appliance during an electrical storm.*

Unplug all electrical appliances when you know an electrical storm is approaching. Lightning can pass through your household wiring and damage any device connected to it. This phone is no exception.

Caution: *Changes or modifications to this product not expressly approved by Uniden, or operation of this product in any way other than as detailed by this Operating Guide, could void your authority to operate this product.*

Range

Your new phone is designed to achieve the maximum possible range by transmitting and receiving according to the highest specifications set forth by the FCC and IC. We have rated this phone to operate at a maximum distance with the qualification that the range depends upon the environment in which the telephone is used. Many factors limit range, and it would be impossible to include all the variables in our rating. The Maximum Range rating of this phone is meant to be used as a means of comparison against other range claims.

Telephone Line Problems

The FCC and IC have granted the telephone company the right to disconnect service in the event that your phone causes problems on the telephone line. Also, the telephone company may make changes in facilities and services which may affect the operation of your unit. However, your telephone company must give adequate notice in writing prior to such actions to allow you time for making necessary arrangements to continue uninterrupted service.

If you are having trouble with your telephone service, you must first disconnect your phone to determine if it is the cause of your problem. If you determine that it is the cause, you must leave it disconnected until the trouble has been corrected.

Radio Interference

Radio interference may occasionally cause buzzing and humming in your cordless Handset, or clicking noises in the Base Unit. This interference is caused by external sources such as a TV, refrigerator, vacuum cleaner, fluorescent lighting, computer equipment, or electrical storm. Your unit is NOT DEFECTIVE. If these noises continue and are too distracting, please check around your office to see what appliances may be causing the problem. In addition, we recommend that the Base not be plugged into a circuit that also powers a major appliance because of the potential for interference. Be certain that the antenna on the unit is fully extended when needed.

In the unlikely event that you consistently hear other voices or distracting transmissions on your phone, you may be receiving radio signals from another cordless telephone or another source of interference. If you cannot eliminate this type of interference, you need to change to a different channel.

Finally, it should be noted that some cordless telephones operate at frequencies that may cause interference to nearby TVs and VCRs. To minimize or prevent such interference, the base of the cordless telephone should not be placed near or on top of a TV or VCR. If interference is experienced, moving the cordless telephone farther away from the TV or VCR will often reduce or eliminate the interference.

More Than One Cordless Telephone

If you want to use more than one cordless telephone in your office, they must operate on different channels. Press the channel key to select a channel that provides the clearest communication.

Privacy

Note: Cordless phones are radio devices. Communications between the Handset and Base Unit of your cordless telephone are accomplished by means of radio waves which are broadcasted over the open airways. Because of the inherent physical properties of radio waves, your communications can be received by radio receiving devices other than your own cordless telephone unit. Consequently, any communications using your cordless telephone may not be private.

ANA 9710 Features

- Super Long Range 900MHz Digital Spread Spectrum
- 2-line, 16-digit LCD Display
- Headset Jack
- Ringer Volume Control
- Handset Volume Control
- Single button access to: CONFERENCE, HOLD, and TRANSFER features
- Four Function Keys: PAUSE, FLASH, REDIAL, SEARCH
- 20 Number Memory Store and Search
- Separate Charging Stand with Spare Battery Charging Capability
- AutoStandby
- AutoTalk
- Vibrate Ringer Alert
- Easy Installation
- Out of Range Protection
- Low Battery Protection System
- Wall Mountable separate Base Unit
- Wall Mountable separate Charging Unit
- Headset Jack (2.5mm)

Installing Your ANA 9710

Selecting the Installation Location

Select a location for the **ANA 9710** that avoids excessive heat or humidity. The Base Unit of your **ANA 9710** can be placed on a desk or tabletop near a standard 120V AC outlet and telephone line jack. The Base Unit can also be mounted on a **standard** AT&T or GTE wall plate using the optional Wall Mount Adapter. If you will use the **ANA 9710** with a Standard 2500 type Telephone Desk Unit, place the **ANA 9710** near that phone. Keep the Base Unit and Handset away from sources of electrical noise (motors, fluorescent lighting, computers).

Connecting the Telephone Line

There are two types of phone outlets:

1. Modular Jack

Plug the telephone line cord from the Base Unit into a standard modular telephone jack. (Note: If you do not have a modular jack, contact your local telephone company for information on the installation of these jacks.)

2. Hardwired Jack

A modular jack converter (not included) is required. You may need to rewire when connecting the converter (making color-coded connections).

Note: Your Uniden Telephone Dealer or a telephone supply store can advise you on the proper adapter or converter.

Connecting the Telephone Cords

The ANA 9710 must be connected to an analog PBX port or a standard analog telephone line.

CAUTION:

- Never install telephone wiring during a lightning storm.
- Never touch uninsulated telephone wires or terminals unless the telephone line has been disconnected at the network interface.
- Use caution when installing or modifying telephone lines.

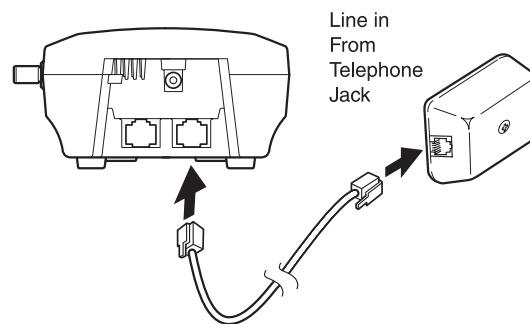

You can also connect a standard 2500-type desk phone to the ANA 9710:

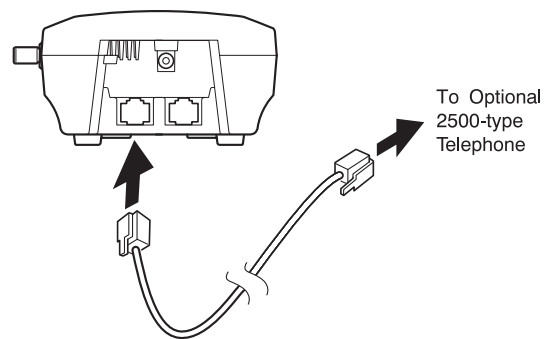

Connect to the LINE OUT Jack

Tone/Pulse Switch

Be sure the TONE/PULSE switch is in the TONE position.

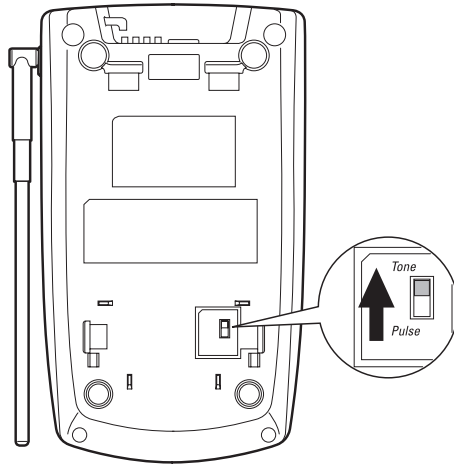

Note: Most systems are Tone dialing. Check with your PBX Administrator if you are not sure whether your system is Tone or Pulse dialing.

Applying Power to the Base and Charger Units

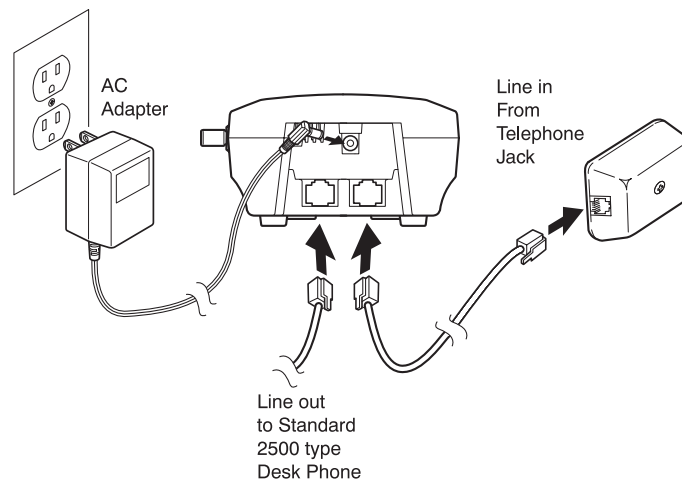

Use only the supplied AC Adapter: EXP9704

IMPORTANT! Place the power cord so that it does not create a trip hazard, or where it could become chafed and create a fire or other electrical hazards.

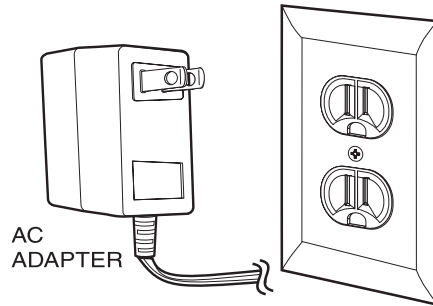

Note: If you cannot plug the AC Adapter into the outlet, contact someone about replacing the outlet.

The unique design of your **ANA 9710** allows you to place the Handset in the Charging Unit with or without the Beltclip attached. The Charging Unit also has the ability to charge a second battery with or without the Handset being charged. The Battery Packs can automatically be recharged either in or out of the Handset.

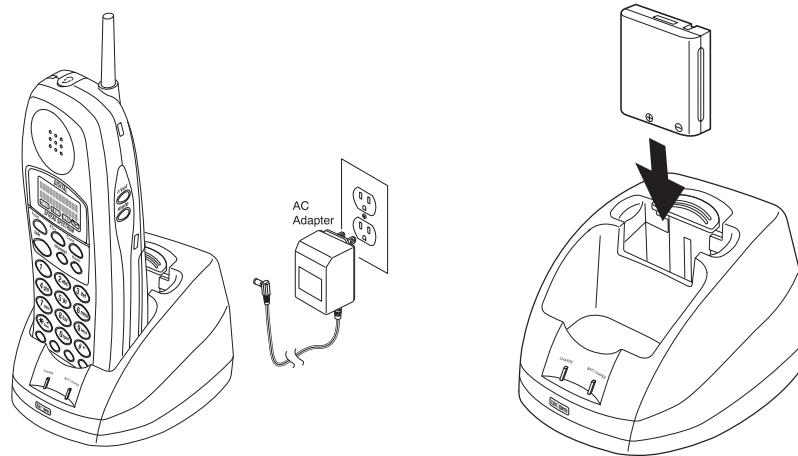

Use only the supplied AC Adapter: AD-970

Wall Installation

Standard Wall Plate Mounting

This Phone is designed to be mounted on a standard AT&T or GTE wall plate. To attach the wall mount stand to the Base Unit:

1. Slide the Wall Mount stand into the notches at the top of the Base Unit, push the Wall Mount stand down and snap it into place.

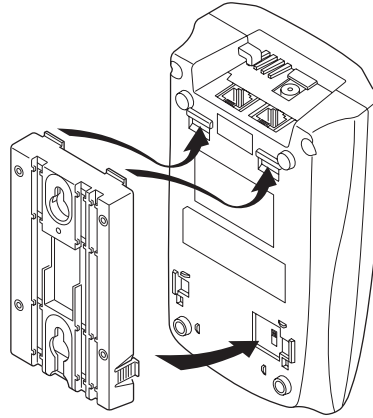

2. Plug the AC Adapter into the Base Unit as previously described.
3. Place the AC Adapter cord inside the molded channel of the Wall Mount stand.

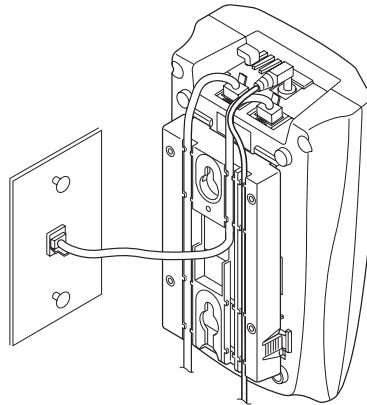

4. Plug one end of the short telephone cord into the **LINE** jack on the Base Unit. Optionally, plug one end of a standard 2500 type desk phone into the **PHONE** jack. Then place the telephone cord(s) inside the molded channel(s) on the bottom of the Wall Mount stand.
5. Plug the other end of the short telephone cord into the modular wall jack.

6. Place the Base Unit on the posts of the wall plate and push down until it's firmly seated.

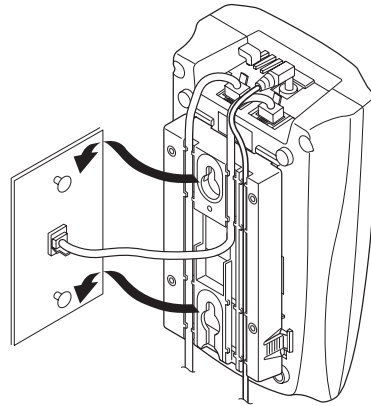

7. Plug the AC Adapter into a standard 120V AC wall outlet.

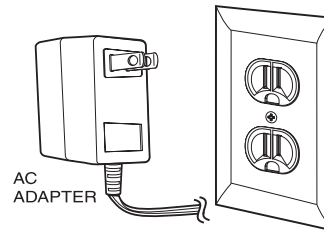

Note: Do not use an outlet controlled by a wall switch.

Direct Wall Mounting

If you do not have a standard wall plate, you can mount your phone directly on a wall. Before mounting your phone, consider the following:

- Select a location away from electrical cables, pipes, or other items behind the mounting location that could cause a hazard when inserting screws into the wall.
- Make sure the wall material is capable of supporting the weight of the Base Unit.
- Use #10 screws with anchoring devices suitable for the wall material where the Base Unit will be placed.

1. Insert two mounting screws into the wall 3-15/16 inches apart. Allow about 3/16 of an inch between the wall and screw heads for mounting the phone.

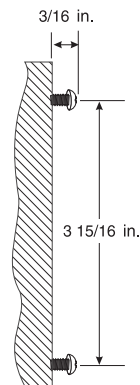

2. Plug and secure the AC Adapter cord by following steps 2 and 3 of the **Standard Wall Plate Mounting**.

3. Plug one end of the telephone line cord into the **LINE** jack on the Base Unit. Optionally, plug one end of a standard 2500 type desk phone into the **PHONE** jack. Then place the telephone cord(s) inside the molded channel(s) on the bottom of the Wall Mount stand.

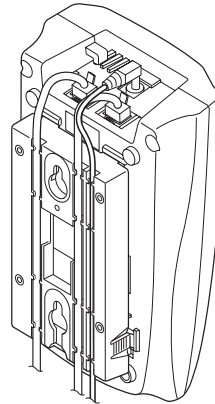

4. Place the Base Unit on the posts of the wall screws and push down until it is firmly seated.

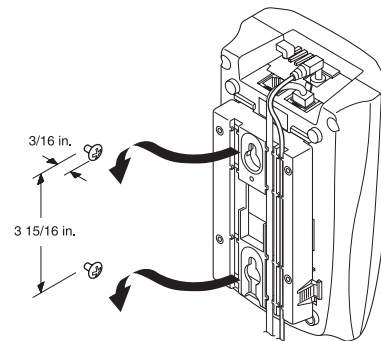

5. Plug the other end of the short telephone cord into a telephone wall jack.

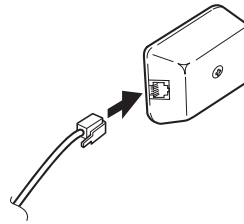

6. Plug the AC Adapter into a standard 120V AC wall outlet by following step 7 of the **Standard Wall Plate Mounting**.

Charging Unit Wall Mounting

The Charging Unit is also designed to be wall mounted. You can mount your phone directly on a wall. Before mounting your charging unit, consider the following:

- Select a location away from electrical cables, pipes, or other items behind the mounting location that could cause a hazard when inserting screws into the wall.
- Make sure the wall material is capable of supporting the weight of the Charging Unit.
- Use #10 screws with anchoring devices suitable for the wall material where the Charging Unit will be placed.

1. Insert two mounting screws into the wall 1-9/10 inches apart. Allow about 3/16 of an inch between the wall and screw heads for mounting the phone.

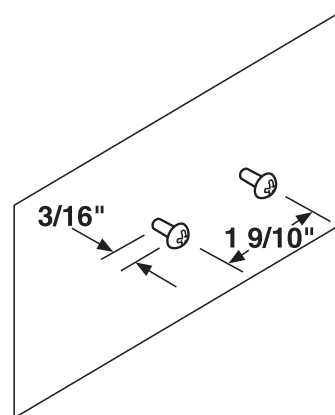

2. Plug the AC Adapter into the Charging Unit as previously described. Wrap the AC Adapter cord around the strain relief.

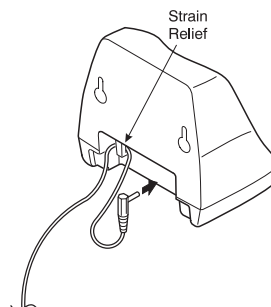

3. Place the Charging Unit on the posts of the wall screws and push down until it is firmly seated.

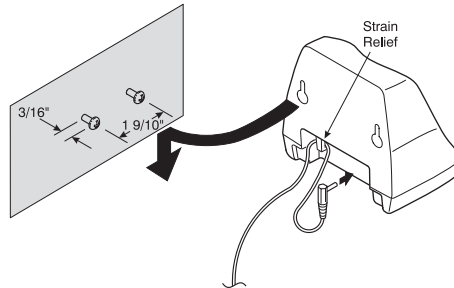

4. Plug the AC Adapter into a standard 120V AC wall outlet.

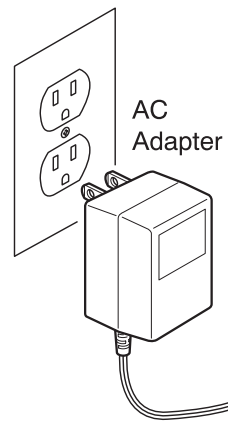

Attaching the Beltclip to the Handset

You can use the Beltclip to attach the Handset to your belt or pocket for convenient portability.

1. Slide the clip into the tab slot.

(CAUTION: The Beltclip is designed to fit snugly onto the Handset.)

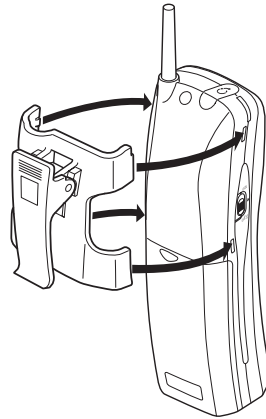

2. Press firmly until it snaps into place.

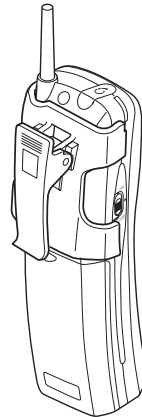

3. To remove, simply press the retain clip in toward the Beltclip blade and slide the clip up at the same time.

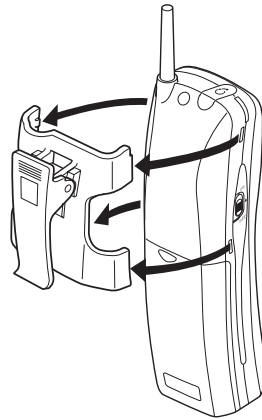

Installing the Handset Battery Pack

1. Remove the battery cover by pressing the latch and sliding the cover down until it comes off the Handset.

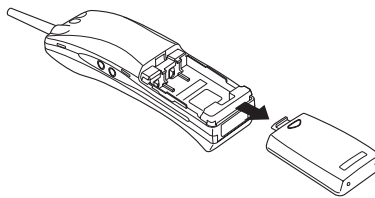

2. Slide the Battery Pack down into the Handset.

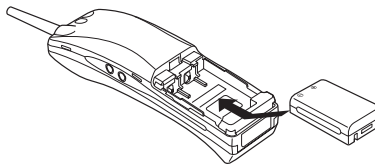

Note: You may have to remove the old battery at this time.

3. Securely close the battery compartment cover by sliding it up until it snaps into place.

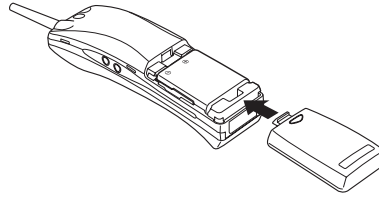

Charging the Handset Battery Pack

The Rechargeable Nickel-Cadmium Battery Pack must be fully charged before using your **ANA 9710** for the first time.
(*Note: Charge the Battery Pack without interruption for 5 hours.*)

1. Place the Handset in the front slot of the Charging Unit.
2. Make sure the CHARGE indicator lights. If the CHARGE light doesn't light, check to see that the AC Adapter is plugged in, and that the Handset is making good contact with the Charging Unit charging contacts.

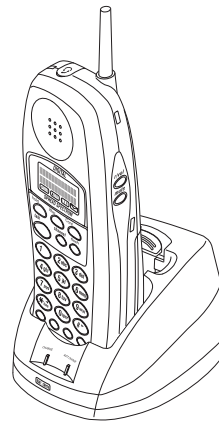

Charging Spare Battery Packs

The Charger Unit of your ANA 9710 is equipped to charge the Spare Battery Pack with or without the Handset in the front slot.

1. Slide the Spare Battery Pack into the second slot in the Charging Unit until the retaining clip snaps over the top of the pack.
2. Make sure the BATT CHARGE indicator lights. If the BATT CHARGE indicator doesn't light, check to see that the AC Adapter is plugged in, and that the Battery Pack is making good contact with the Charging Unit charging contacts.

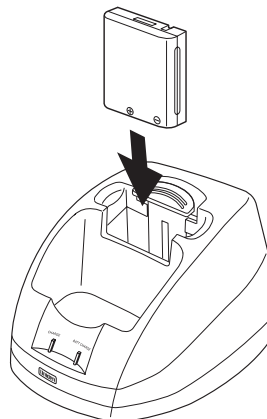

Note: Charge the Battery Pack without interruption for 12-15 hours.

3. When charging is complete, press out on the latch and remove the Battery Pack for use. Or, if you don't need the Battery pack immediately, leave it in the Charging Compartment; it will not overcharge.

Low Battery Indicator

When the Battery Pack in the Handset is low and needs to be charged, you will see a message on the display.

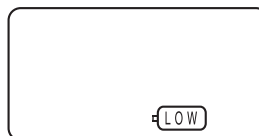

On a Call	In Standby Mode
All keys and functions are available.	None of the buttons operate.
Handset beeps once every 3 seconds	Handset beeps every 15 seconds for 3 minutes.
Complete your call as quickly as possible	Cannot make or receive a call.
Replace Battery pack within 20 seconds to continue call.	Replace Battery Pack before making a call.

Return the Handset to the Charging Unit for charging or replace the Handset Battery Pack with another charged Battery Pack.

Cleaning the Battery and Charging Unit Contacts

To maintain a good charge, it is important to clean all charging contacts on the Handset, Spare Battery Pack and Charging Unit about once a month. Use a pencil eraser or a soft dry cloth. Do not use any liquids or solvents.

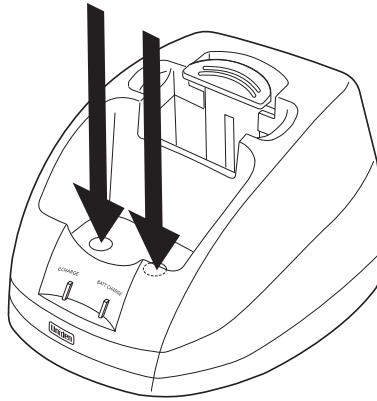

Using Your ANA 9710 Handset

Before using your ANA 9710, be sure to raise the antenna to the vertical position.

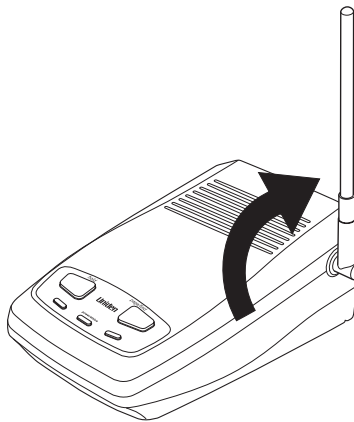

Note: Operation of the ANA 9710 is performed using the Handset out of the Charging Unit.

ANA 9710 Handset Controls

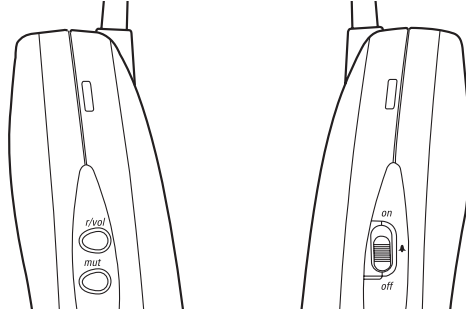

Earpiece Volume

Press *r/vol* on the side of the Handset during a call to change the earpiece volume on the handset.

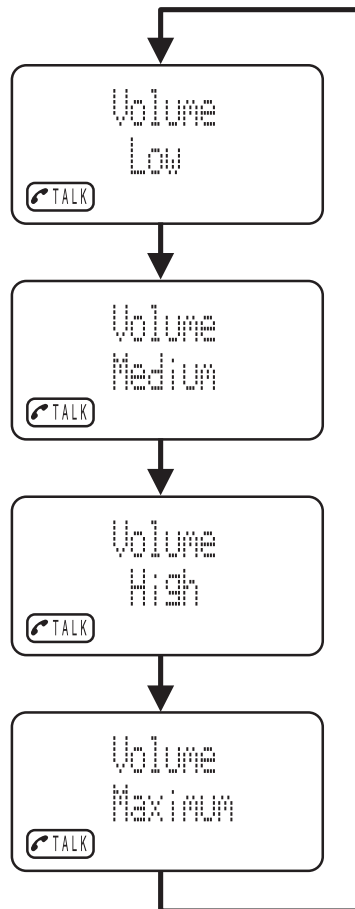

Handset Ringer tone and volume

Press **r/vol** on the side of the Handset in Standby mode to select seven ringer tones and volume combinations.

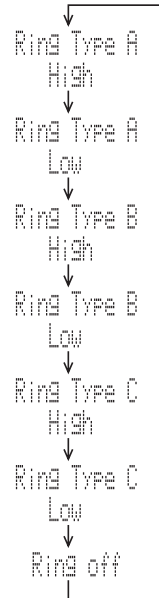

Vibrate Mode

“Ring off” shown on the above display is the Vibrate Mode.

If you set the ringer off and the Handset is not on the charger, the Handset will vibrate when there is an incoming call.

If you set the ringer off and the Handset is on the charger, the Handset will ring as Ring Type-A Low.

Handset Ringer Switch

The switch on the side of the Handset turns the handset ringer on or off.

When the switch on the side of the Handset is turned off, you will see the ring off icon.



When the switch on the side of the Handset is turned on, the ring off icon will disappear.

Using the Handset

When you pick up the Handset and press **talk**, you will see:

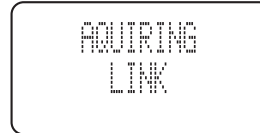

After the connection has been made between the Handset and Base, you will see:

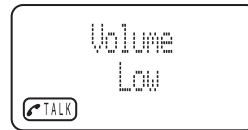

Or, you may see one of the following:

Condition	Indicator	LCD Screen
No Connection to Base Unit	Error Tone	
Line in Use	Error Tone	

If the Handset is at the range limit of the **ANA 9710**, or no power is going to the Base Unit, you may see:

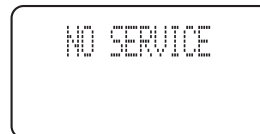

Answering a Call

When you receive a call, the Handset rings and you will see:

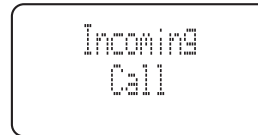

Handset in the Charging Unit	Handset out of Charging Unit
Pick up the Handset. The AutoTalk feature allows you to answer the call immediately.	Press talk
When you finish the call, place the Handset back in the Charging Unit. AutoStandby automatically hangs up the phone.	
—OR—	
Press talk to hang up the phone	

Making a Call

Press **talk**. The talk icon will illuminate after the Handset/Base are connected, and you will see:

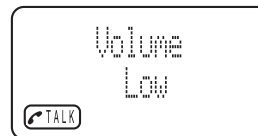

When you hear a dial tone, enter the number you are calling. (You can also dial from memory. See the section on "Using Memory.")

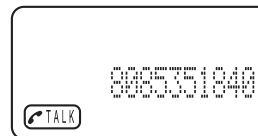

When you finish the call, press the **talk** button again, this will hang up the phone and put it in AutoStandby.



Feature Buttons

Note: The exact operation of the Feature Buttons depends on how your PBX system is configured. Contact your PBX Administrator for more information.

Placing a call “on hold”

Press **hold**. You will hear a “beep” and see:

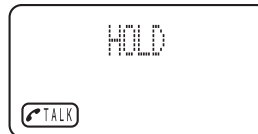

To resume the call, press **hold** or **talk**.

Transferring a Call

Press **xfer** (TRANSFER). You will hear a “beep” and see:



The dial numbers saved in xfer memory is shown on the display after 2 seconds.



When the receiving party answers, press **xfer** to complete the transfer.

Connecting a Conference Call

To connect a second party to a call in progress, press **conf** (CONFERENCE). You will hear a “beep” and see:



The dial numbers saved in conf memory is shown on the display after 2 seconds.



When the other party answers, press **conf** to have a three-way conversation.

Programming the Feature Buttons

The Transfer and Conference Keys can be programmed for special use, such as causing a “Hook Flash” followed by a special number or function.

For example — to program the **xfer** key for “Hook Flash” and 9 for outside transfers only:

Press **mem.**

PHONE No.?

Press **flash.**

F

Press **9.**

F9

Press **mem.**

LOCATION ?

Press **xfer.**

STORING

Note: The ANA 9710, conference and transfer keys are operated by the Hook Flash function. Please, program your system transfer or conference code with the assistance of the PBX System Administrator.



Function Keys

HOLD

Press once, you will hear a “beep” and the call is placed on hold.

Press **hold** or **talk** to resume the call (local hold).

XFER

Press **xfer** (Transfer), you will hear a “beep”.

CONF

To connect a second party to a call in progress, press **conf** (CONFERENCE). You will hear a “beep”.

FLASH

Press once to cause a “Hook Flash” while on a call.

Press once to program a “Hook Flash” in a Feature Button.

REDIAL

To dial the last number called, press **talk**, then **rdl**. The phone will redial the last number called.

PAUSE

Press once to program a Pause while storing a number in Memory.

SEARCH

Press to begin Memory Search. (See the following Section for Memory Search.)

MEMO

Press **mem**.

Press desired function.

Press memory location (1-20).

Press **mem**, then **xfer**.

Using Your ANA 9710 Memory

Use these buttons to operate the ANA 9710 Memory

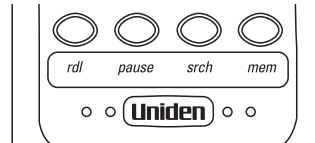

Storing a Number

1. Press **mem**. You will hear a beep, and see the message:



2. Enter the number (up to 20 digits) you want to store.

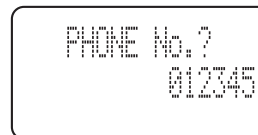

- a. To program a Pause in the dialing sequence, press **pause**.

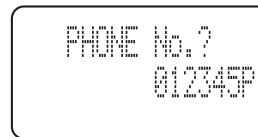

3. Press **mem**. You will see the message:



4. Enter the number (01) to (20) for the memory location to store. You will hear a confirmation beep and see the message:



*Note: After pressing **mem** the second time, you have 20 seconds to enter the memory location. Otherwise, an error tone sounds and the unit returns to Standby.*

5. The ANA 9710 then returns to Standby mode.

Example: Store 555-1234 in memory location 12:

A. Press *mem*.

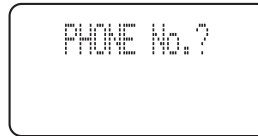

B. Enter **5551234**.



C. Press *mem*.



D. Press **12**.

The Handset beeps. This is confirmation that you have programmed 5551234 into memory location 12 and you will see:

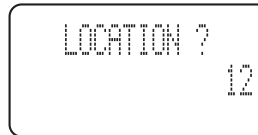

The phone then returns to Standby.

Erasing a Stored Number

1. Press *mem*.

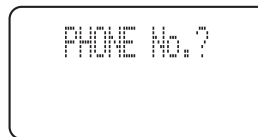

2. Press *mem*.



3. Enter the memory location number (01) to (20) you want to clear. You will hear a long beep and see:

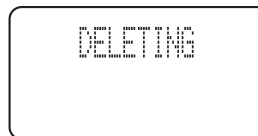

Dialing with a Stored Number

Note: The following applies when the phone is in Standby Mode, and you have already established a connection between the Handset and Base Unit.

1. Press **talk**.
2. Press **mem**.

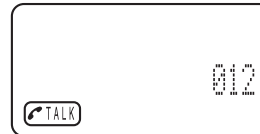

3. Enter the Memory Location (01 - 20).

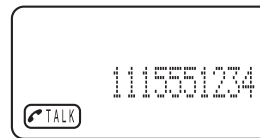

The phone automatically dials the number shown.

Memory Search

You can search all 20 Memory Locations to find the number you need. Once you have found the number, you can automatically dial that number by pressing the **talk** key.

1. Press **srch**. Search automatically starts at memory Location 01.

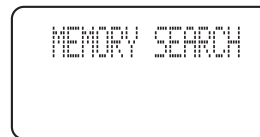

(If Memory Location 01 doesn't have a stored number, search will display the first stored number.)

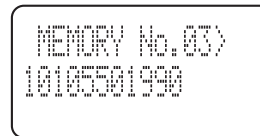

2. Press **r/vol** to move to the next used Programmed Memory Location.
 - A. Continue to press **r/vol** to move through the Programmed Memory Locations.
 - B. You can also press **mute** to move to the previous used Memory Location.

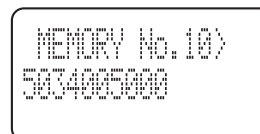

C. Pressing the **mute** key, you will move down through the Memory (20 to 1). Pressing **r/vol** you will move up through the Memory (1 to 20). Press **r/vol** or **mute** until you reach the desired Memory Location.

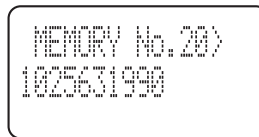

4. Once you have the desired number, press **talk**. The talk icon appears.

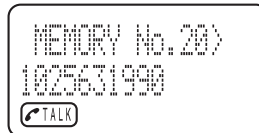

The phone will then automatically dial the number.

Chain Dialing

You can dial any stored number while you are on a call. This is sometimes needed for Long Distance Access Codes or Account Access Numbers.

1. While you are on the call, press **srch**.

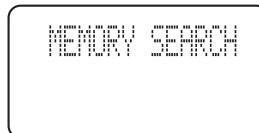

2. Press **r/vol** or **mute** as needed to locate the number in Memory.

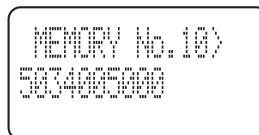

3. Once you have the desired number, press **talk**. The phone dials the number.



Using Your ANA 9710 Base Unit

Although most of the **ANA 9710** operations are performed at the Handset, there are two operations performed at the Base Unit.

The **power/status** LED (2) blinks whenever the Handset is connected to a call.

1. Hold Button
2. Power/Status LED
3. Page/Find Button

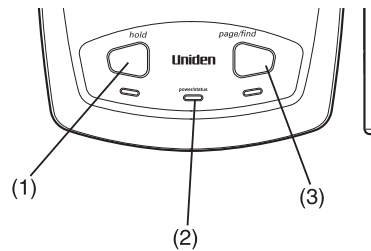

Using the Hold

The **hold** button (1) is used in conjunction with a desk top phone to switch from the Handset to a desk top phone.

1. If you need to use a desk top phone which the **ANA 9710** is connected to, press **hold** on the Base unit then pick up the desk top phone.
2. To resume using the Handset, press **hold** on the Base unit, then press **talk** on the Handset. The Handset resumes functioning as before.

Using the Page/Find

The **page/find** button (3) is used to locate the Handset. Pressing **page/find** will send a ring signal to the Handset.

Note: The Handset Ringer must be on and set to Type A, B or C in order for the **page/find** function to work.

Optional Headset (EXP9530)

The optional Headset provides a “Hands-Free” Option for the **ANA 9710**. With the Headset installed, you can use the Beltclip to carry the Handset, and conduct a conversation using the Headset.

To install the optional Headset, open the cover over the Headset Jack and plug the Headset in.

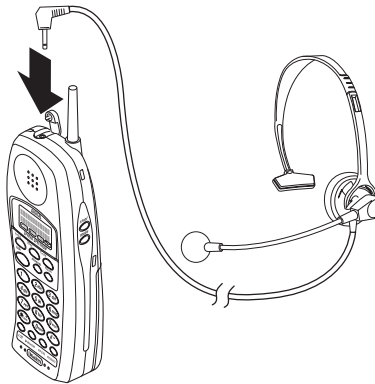

No other settings are needed.

Operation of the **ANA 9710** using the Headset is exactly the same as using the Handset. However, you will hear through the Headset earphone, and talk through the Headset microphone. The Handset earphone and microphone (mouthpiece) are disconnected.

Using an Optional Second 2500-type Analog Telephone

Analog Telephone

A standard 2500-type Desk telephone can be used with the **ANA 9710**. Calls can then be answered with the Desk phone and transferred to the **ANA 9710**.

Note: A special Security Feature disconnects the Desk phone whenever the **ANA 9710** Handset is in use.

Connecting the Desk Telephone.

Connect a telephone cord from the Desk phone to the **LINE OUT** jack on the **ANA 9710** Base Unit.

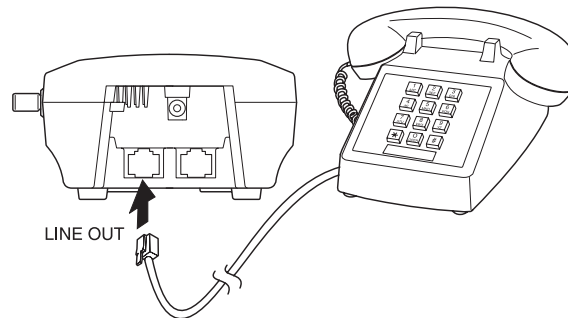

The Desk phone can now be used to answer or place calls in the normal manner.

Transferring a Call to the ANA 9710.

1. Press **hold** on the Base unit and press **talk** on the Handset.

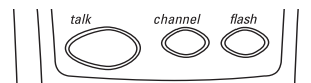

The call is now transferred to the **ANA 9710**, and the Desk phone is disconnected.

Transferring a Call to the Desk Telephone

1. Press **hold** on the **ANA 9710** Base Unit.
2. Pick up the Desk phone and press **talk** on the Handset.

The **ANA 9710** Handset disconnects.

Typical Applications

You can use the **ANA 9710** together with a standard PBX telephone to give you effective business communications both at your desk and away from it. Contact your PBX Administrator for more information about your System.

You can have your PBX system programmed so the following sequence occurs:

1. Your PBX telephone rings first.
2. If you don't answer the PBX telephone after a set number of rings, the call is automatically transferred to the **ANA 9710**.
3. If you don't answer the call after a set number of rings, it is automatically transferred to your Voice Mail.

Note: *It is good practice to keep the number of rings in each case to 2 or 3. This gives you a chance to answer the call, and doesn't keep the other party waiting too long.*

Optional Accessories and Replacement Parts

For the following Optional Accessories and Replacement Parts contact your PBX Administrator.

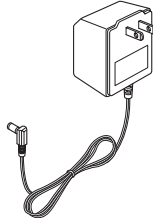

EXP9704 AC
Adapter for Base Unit

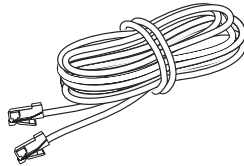

Telephone Cord



Beltclip
EXP9702

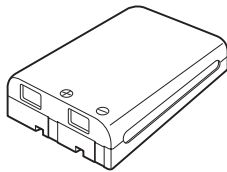

800 mAh Battery
BT-2499

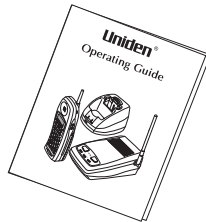

Operating Guide
OMANA9710

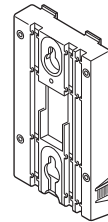

Base Unit Wall Mount
EXP9660



Headset
EXP9660

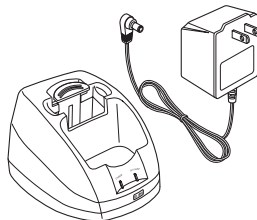

Charger EXP9785
AC Adapter AD970

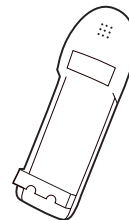

Leather Case
EXP9783

Troubleshooting

If your **ANA 9710** Cordless Telephone is not performing to your expectations, please try these simple steps. If you are still unable to resolve the problems, contact your PBX Administrator.

Note: *Do not attempt to service this unit yourself. All service must be done by qualified service personnel.*

Problem	Suggestion
Charge light won't come on when Handset is placed in Charging Unit.	<ul style="list-style-type: none">• Make sure the AC Adapter is plugged into the Charging Unit and wall outlet.• Make sure Handset is properly seated in Charging Unit.• Make sure the Battery Pack is properly placed in the Handset.• Make sure that the charging contacts on the Handset and Charging Unit are clean.
Conversation interrupted frequently.	<ul style="list-style-type: none">• Make sure that the Base Unit antenna is fully vertical.• Move closer to the Base Unit.
Warning tone and NO SERVICE message.	<ul style="list-style-type: none">• Move closer to the Base Unit.
Handset doesn't ring.	<ul style="list-style-type: none">• The Battery Pack may be weak. Charge the Battery Pack for 5-6 hours.• Make sure the Base Unit antenna is fully vertical.• The Handset may be too far away from the Base Unit.• Ensure the Ringer ON/OFF switch is in the ON Position.

Specifications

General: The ANA 9710 complies with FCC and IC parts 15 and 68.

Frequency Control : Phase Lock Loop
Modulation : Spread Spectrum
Operating Temperature : 0° to 50° C (+32° F to +122° F)

Base Unit

Receive/Transmit Frequency: 902 MHz to 928 MHz
Power Requirements : 10V DC from supplied AC Adapter
Size : 4 1/4 in. W x 7 1/2 in. D x 2 1/4 in. H
Weight : Approx. 15.4 oz.

Handset

Receive/Transmit Frequency: 902 MHz to 928 MHz
Power Requirements : Nickel-Cadmium
Battery Pack
Size : 2 1/5 in. W x 1 2/3 in. D x 8 2/3 in. H
with antenna
Weight : Approx. 8.8 oz. with battery
Battery : Capacity 800 mAh, 3.6 V
Talk Time : 6 hours (typical)
Standby Time : 4 days (typical)

Specifications shown are typical and subject to change without notice.

MEMO

Free Manuals Download Website

<http://myh66.com>

<http://usermanuals.us>

<http://www.somanuals.com>

<http://www.4manuals.cc>

<http://www.manual-lib.com>

<http://www.404manual.com>

<http://www.luxmanual.com>

<http://aubethermostatmanual.com>

Golf course search by state

<http://golfingnear.com>

Email search by domain

<http://emailbydomain.com>

Auto manuals search

<http://auto.somanuals.com>

TV manuals search

<http://tv.somanuals.com>