

Uniden®

CEZAI 998

SERIES

OWNER'S

MANUAL

OWNER'S MANUAL

Contents

| | | | |
|--|-----------|---|-----------|
| Welcome | 3 | Base Setup | 19 |
| Accessibility | 3 | Selecting a Language for your Answering Machine and Base Display | 19 |
| Terminology | 4 | Setting the Day and Time | 19 |
| Product Overview | 5 | Adjusting the Base Display (LCD Contrast) . | 20 |
| Main Phone Features | 5 | Setting the Area Code | 20 |
| Answering Machine Features | 5 | Setting Caller ID on Call Waiting (CIDCW) . | 21 |
| Parts of the Base and Corded Handset | 6 | Handset Setup | 21 |
| Parts of the Cordless Handset | 8 | Selecting a Language for the Handset Display | 21 |
| Parts of the Cordless Handset Charging Cradle | 9 | Setting AutoTalk | 22 |
| Using the Interface | 10 | Checking the Area Code Setting from the Handset | 22 |
| Using the Base Menus | 10 | Emergency Dialing From the Base & Cordless Handset | 23 |
| Using the Handset Menus | 10 | One-touch Speed Dialing from the Base | 24 |
| Installing the Phone | 11 | Speed Dialing from the Cordless Handset | 25 |
| Choosing the Best Location | 11 | Storing Names and Numbers for Speed Dialing | 25 |
| Connecting the Base and Corded Handset . | 12 | Storing Caller ID Information to Speed Dial Locations | 28 |
| Testing the Connection | 13 | Using Your Phone | 29 |
| Changing the Dial Mode | 13 | During a Power Failure | 29 |
| Adjusting the Visual Ringer Brightness | 14 | Making and Receiving Calls | 30 |
| Turning CID Announce On/Off | 14 | Call Waiting | 32 |
| Wall Mounting the Base | 15 | Redialing the Last Number Dialed | 33 |
| Connecting the Cordless Handset and Charger | 17 | | |
| Installing the Beltclip | 18 | | |
| Installing the Optional Headset | 18 | | |

| | | | |
|---|-----------|--|-----------|
| Adjusting the Ringer, Earpiece and Speaker Volume | 34 | Using Your Answering Machine | 50 |
| Audio Boost for the Cordless Handset | 35 | Turning your Answering System On & Off | 50 |
| Selecting a Different Channel | 36 | Reviewing Messages | 51 |
| Finding the Lost Handset | 36 | Screening Calls | 52 |
| Placing a Call on Hold from the Base | 36 | Remotely Operating Your Answering Machine | 52 |
| Conferencing | 37 | Maintenance | 54 |
| Intercom | 38 | Specifications | 54 |
| Transferring a Call | 39 | Power Failure | 54 |
| Tone Dialing Switch Over | 40 | Battery Life | 55 |
| Using Caller ID and Call Waiting | 41 | Low battery alert | 55 |
| Using the CID Announce (Base Only) | 42 | Battery Replacement and Handling | 55 |
| Viewing Caller ID Information | 42 | Installing the Rechargeable Battery for Cordless Handset | 56 |
| Deleting Information from the Caller ID List | 43 | Cleaning the Battery Charging Contacts | 57 |
| Setting Up the Answering Machine | 45 | Troubleshooting | 58 |
| Features | 45 | Traveling Out of Range | 58 |
| Selecting a Language | 45 | Common Issues | 58 |
| Setting the Record Time (or Announce Only) | 46 | Liquid Damage | 61 |
| Activating Call Screening | 46 | Precautions | 62 |
| Setting the Number of Rings | 47 | Important Safety Instructions | 63 |
| Activating the Message Alert | 47 | The FCC Wants You To Know | 64 |
| Setting Your Greeting | 48 | I.C. Notice | 67 |
| Selecting Your Greeting | 49 | One Year Limited Warranty | 68 |
| Setting a Security Code or Personal Identification Number (PIN) | 49 | Index | 70 |
| | | Remote Operation Card | |

Welcome

Congratulations on purchasing your new Uniden Corded/Cordless Telephone! Your new phone system comes with a corded base unit and a cordless handset. The corded base allows you the convenience, safety and security to make and receive calls during a power failure. In addition to the corded base, your new phone has a full featured cordless handset and charger that can be placed anywhere in your home where you have AC power and it does not require you to plug the handset in to a telephone line.

Note: Illustrations in this manual are used for explanation purposes.

Some illustrations in this manual may differ from the actual unit.

Uniden® is a registered trademark of Uniden America Corporation.

AutoTalk, AutoStandby and UltraClear Plus are trademarks of Uniden America Corporation.

Accessibility

Uniden provides a customer service hotline for accessibility questions. If you have a disability and need customer service assistance or if you have any questions about how Uniden's products can accommodate persons with disabilities, please call the accessibility voice/TTY line: 1-800-874-9314.

A representative is available to talk to you M-F, 8:00 am to 5:00 pm, CST. After hours, you can leave us a message, and we will call you back. Information is also available on our website, www.uniden.com, under the "Accessibility" link.

Terminology

| | |
|---------------------|--|
| Base | The main part of the phone that connects to your phone line and lets you make and receive calls. |
| Charger | A cradle that charges the handset battery. It connects to power but does not connect to a phone line. |
| CID | Caller ID is available from your telephone provider. With this service, you can see the name and number of incoming callers. |
| CID Announce | The Caller ID that Talks. The base will announce the name of incoming callers if you subscribe to Caller ID service. |
| CIDCW | Caller ID on Call Waiting is available from your telephone provider. With this service, you can see incoming caller information while on another call. |

| | |
|-----------------------------------|--|
| Corded Handset on the Base | A handset connected to the Base. It can make and receive calls during a power failure. |
| Emergency Dial | One touch speed dial key for your most important or most frequently called number. |
| Handset | A cordless handset that can be placed anywhere in your home or office where AC power is available. |
| Standby | The handset is not in use. No line has been activated. The corded base handset is on the base and [talk] on the base has not been pressed. No dial tone is present. |
| Station | The Cordless handset or base phone. |
| Talk | When a dial tone has been enabled allowing the user to dial and carry on a conversation with an outside party. |

Product Overview

Main Phone Features

- 5.8GHz Extended Range Technology
- Coded/Cordless Telephone System
- Visual Ringer
- Large Backlit Keys
- Dual Keypad and Backlit Screens
- Make and Receive Calls During a Power Failure
- Integrated Answering Machine
- Base Speakerphone
- Caller ID and Caller ID on Call Waiting
- 50 Number Caller ID List
- CID Announce - The Caller ID that Talks!
- Trilingual Display Options and Voice Prompts (English, French and Spanish)
- One-Touch Emergency Dial in the Base and Cordless Handset
- 4 One-touch Speed Dial Numbers in the Base
- 10 Speed Dial Numbers in the Cordless Handset
- Ringer Volume Control
- Earpiece Volume Control
- Audio Boost for the Cordless Handset
- Hearing Aid Compatible
- Find Lost Handset
- Clock Display in the Base
- Intercom Between Cordless Handset and Base
- Hold Feature

Answering Machine Features

- Digital Tapeless Recording
- Up to 15 minutes of Recording Time
- Call Screening
- Personal or Pre-recorded Outgoing Messages
- Time and Day Announcement
- Trilingual Display and Voice Prompts (English, Spanish, or French)
- Remote Message Retrieval
- Toll Saver
- Message Alert

Parts of the Base and Corded Handset

Top view

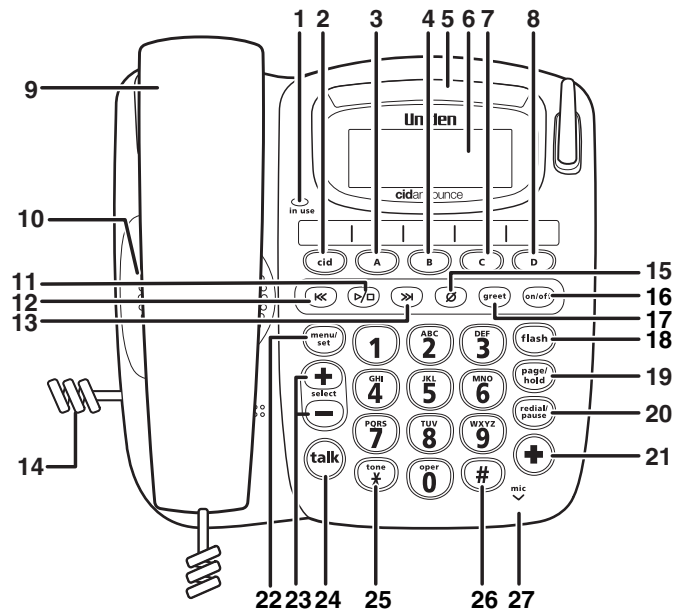

1. in use light

2. [cid] key

3. One-touch speed dial [A] key

4. One-touch speed dial [B] key

5. Base visual ringer

6. Base display

7. One-touch speed dial key [C]

8. One-touch speed dial key [D]

9. Corded base handset

10. Base speaker

11. [▶/□] (play/stop) key

12. [||<<] (repeat/rewind) key

13. [>>|] (skip/forward) key

14. Curl cord

15. [∅] (delete) key

16. [on/off] key / answer on/off light

17. [greet] key

18. [flash] key

19. [page/hold] key

20. [redial/pause] key

21. Base Emergency [+ key

22. [menu/set] key

23. [select/+ key and [select/- key

24. [talk] key / speaker light

25. [*/tone] key

26. [#] key

27. Microphone

Side and Rear view

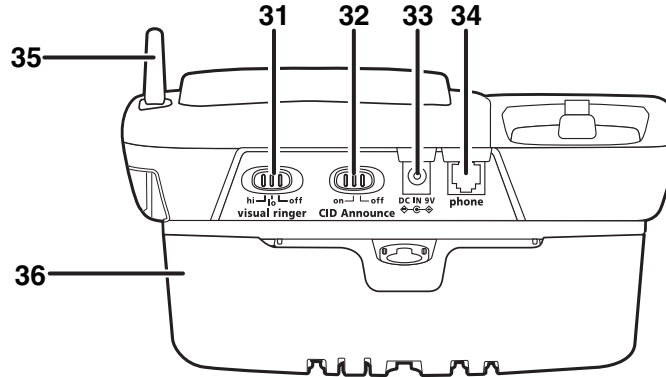
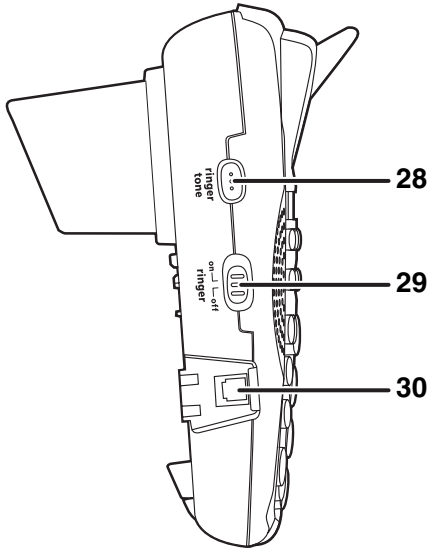

- | | |
|---|-------------------------------|
| 28. ringer tone button | 33. DC IN 9V jack |
| 29. ringer on/off switch | 34. phone jack |
| 30. Curl cord jack | 35. Base antenna |
| 31. visual ringer hi/lo/off switch | 36. Wall mount adapter |
| 32. CID Announce on/off switch | |

Parts of the Cordless Handset

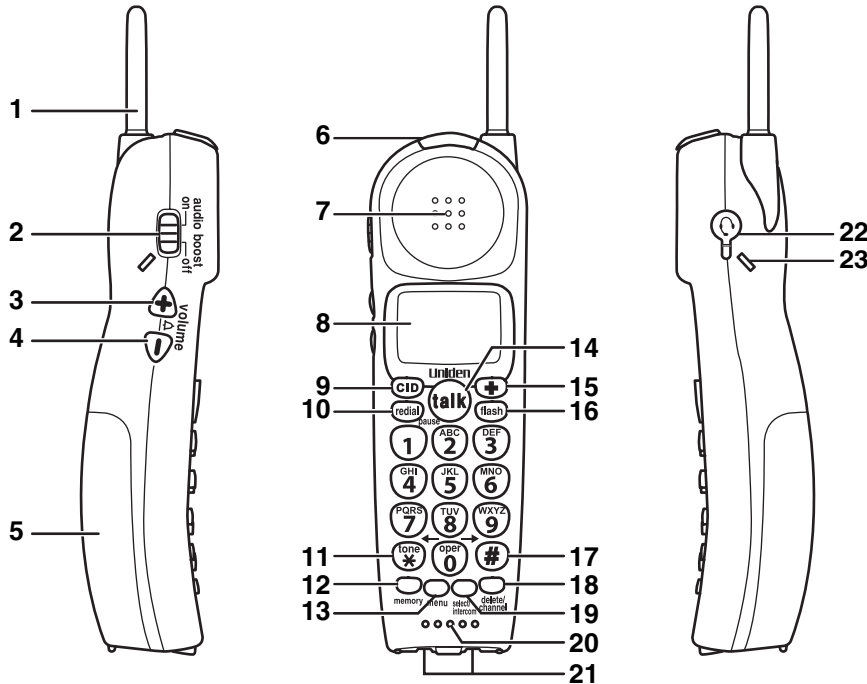

1. Handset antenna
2. **audio boost on/off** switch
3. Volume/ringer up [**volume/▲/+**] key
4. Volume/ringer down [**volume/△/-**] key
5. Handset battery compartment
6. Handset visual ringer
7. Handset earpiece
8. Handset display
9. **[CID]** key
10. **[redial/pause]** key
11. **[*/tone/←]** key
12. **[memory]** key
13. **[menu]** key
14. **[talk]** key
15. Handset Emergency [**+**] key
16. **[flash]** key
17. **[#/→]** (pound) key
18. **[delete/channel]** key
19. **[select/intercom]** key
20. Handset microphone and ringer speaker
21. Handset charging contacts
22. Headset jack
23. Beltclip hole

Parts of the Cordless Handset Charging Cradle

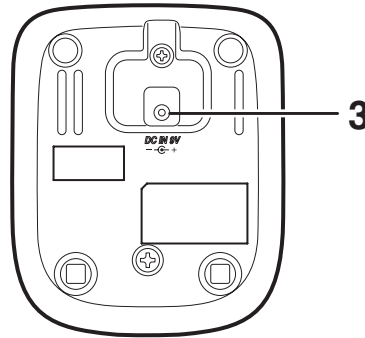
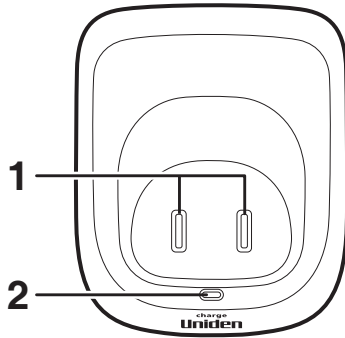

1. Charging contacts
2. Charge light
3. **DC IN 9V** jack

Using the Interface

Using the Base Menus

- Press **[menu/set]** on the base to access the base main menu.
- Use **[select/+]** or **[select/-]** to scroll through options.
- Press **[menu/set]** on the base to make a selection.
- For your convenience, voice prompts will guide you through the base main menu (except LCD Contrast and Dial Mode settings).
- To cancel your selection and return to standby, press **[▶/◻]** (play/stop) on the base.
- If you do not press a key within 30 seconds, the phone will time out and exit the menu. When setting Day and Time, the time-out period is extended to two minutes.

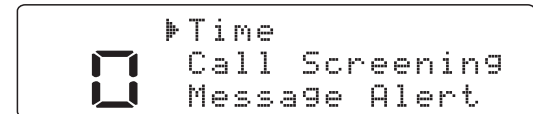
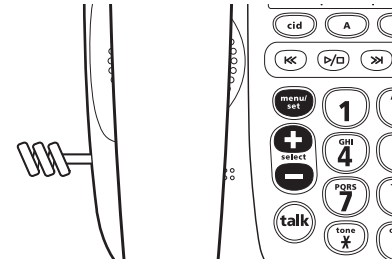

Using the Handset Menus

- Press **[menu]** on the cordless handset to access the main menu.
- Use **[volume/▲/+]** or **[volume/▲/-]** to scroll through the options.
- Press **[select/intercom]** on the cordless handset to make a selection.
- To return to standby, press **[menu]** on the cordless handset, or return the cordless handset to the cradle.

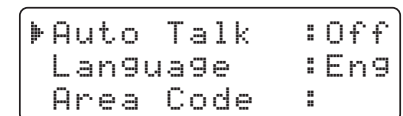
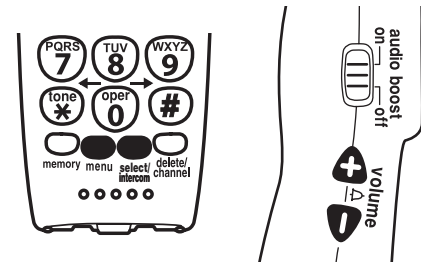

Installing the Phone

Choosing the Best Location

When choosing a location for your new phone, here are some important guidelines you should consider:

Avoid heat sources, such as radiators, air ducts, and sunlight
Avoid television sets and other electronic equipment

Avoid noise sources such as a window by a street with heavy traffic

Avoid microwave ovens

Avoid excessive moisture, extremely low temperatures, dust, mechanical vibration, or shock

Avoid personal computers

Choose a central location

Avoid other cordless telephones

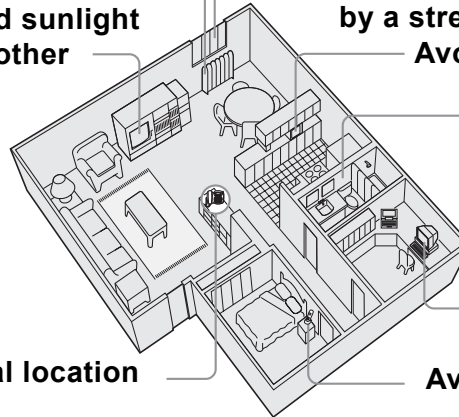

- The location should be close to both a phone jack and a power outlet that is not connected to a wall switch.
- The base and handset should be kept away from sources of electrical noise such as motors, microwave ovens, and fluorescent lighting.
- Don't place the base in direct sunlight or subject it to high temperatures. The battery may not charge properly.
- For better reception, place the base as high as possible.
- The base should be placed in an open area for optimum range and reception.
- If your home has wired alarm equipment connected to a phone line, be sure that installing the system does not disable your alarm equipment. If you have questions about what will disable alarm equipment, contact your telephone company or a qualified installer.

Connecting the Base and Corded Handset

- 1) Connect the corded handset curl cord to the left side of the phone and to the corded handset.
- 2) Route the curl cord inside the molded wiring channel as shown.
- 3) Connect the AC adapter to the **DC IN 9V** jack and to a standard 120V AC wall outlet.

CAUTION: To avoid risk of fire and shock, only use the Uniden AD-1007 AC adapter.

- 4) Route the AC adapter cord inside the molded wiring channel as shown.
- 5) Connect the AC adapter to a continuous power supply (i.e., an outlet that is not controlled by a switch).
- 6) Place the base unit close to the AC outlet to avoid long extension cords.
- 7) Connect the telephone cord to the **phone** jack and to a telephone outlet.
- 8) Set the base on a desk or tabletop. Place the corded base handset in the base cradle.

Tip: If your telephone outlet isn't modular, contact your telephone company for assistance.

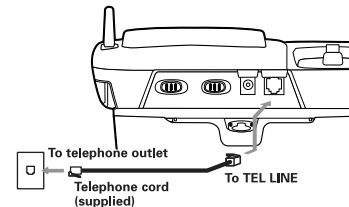
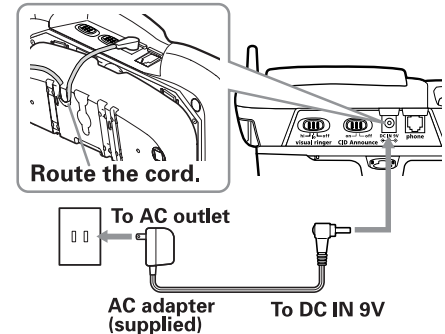
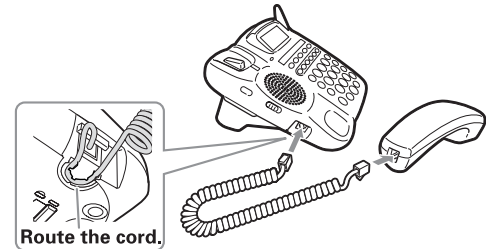

Testing the Connection

There's an easy way to test your connection: try making a call from your base. If your call connects, your phone's settings are fine. If your call does not connect:

- 1) Check the AC adapter cord. Make sure it is securely connected to the **DC IN 9V** connector and to a standard AC power outlet.
- 2) Change Dial Mode (Instructions below).

Changing the Dial Mode

Your phone can communicate with the telephone network in two different ways: tone dialing or pulse dialing. These days, most phone networks use a method called tone dialing, so your phone comes programmed for tone dialing. If your phone company uses pulse dialing, you will need to change your phone's dial mode. If you cannot connect to the telephone network, please follow the steps below to modify your phone's settings:

- 1) Press **[menu/set]** on the base.
- 2) Press **[select/-]** to move the pointer to select DIAL MODE, and then press **[menu/set]**.
- 3) Press **[select/+]** or **[select/-]** to select TONE or PULSE (the initial setting is TONE).
- 4) Press **[menu/set]**. You will hear a confirmation tone.

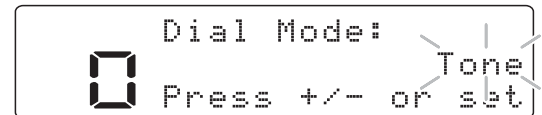

Adjusting the Visual Ringer Brightness

Your new phone has visual ringers located at the top of the base unit and at the top of the cordless handset. These visual ringers will flash during incoming calls, so if you are in a noisy work environment you will be able to see when the phone is ringing. The phone comes with a switch for base visual ringer control, so you can turn the visual ringers off when you do not want the base to flash brightly during incoming calls.

The **visual ringer hi/lo/off** switch allows you to set the brightness and turn off the visual ringer on the base. You can adjust the brightness by selecting one of three options: high, low and off. If you set the switch to off, the visual ringer on the base will not flash at all during incoming calls.

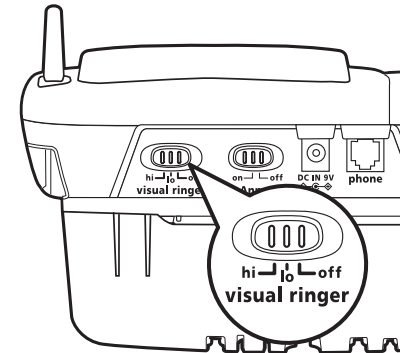

Turning CID Announce On/Off

Your new phone comes with a feature called CID Announce. If you subscribe to Caller ID services from your telephone provider and when this feature is turned on, your base unit will announce the name of the incoming caller when you receive a call. You can turn this feature on or off by moving the **CID Announce on/off** switch to the on or off position as desired.

Note: Your phone will only be able to announce the incoming caller names when that information is available for that call. If a private caller rings you, the announcement will say *Private Caller*.

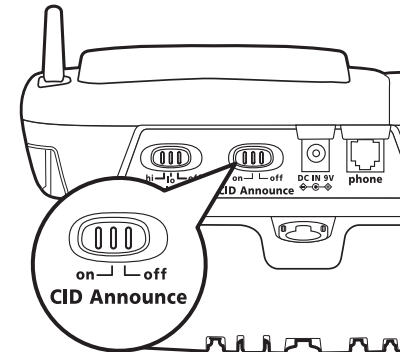

Wall Mounting the Base

This phone can be mounted on any standard wall plate.

- 1) Remove the wall mount adapter from the base and snap it into the notches on the bottom of the base.
- 2) Plug the AC adapter to the **DC IN 9V** jack.
CAUTION: To avoid risk of fire and shock, only use the Uniden AD-1007 AC adapter.
- 3) Route the AC adapter cord inside the molded wiring channel as shown.
- 4) Plug the AC adapter into a standard 120V AC wall outlet.
- 5) Plug the telephone cord into the **phone** jack.
- 6) Route the telephone cord inside the molded wiring channel as shown.
- 7) Plug the telephone cord into the telephone outlet.
- 8) Align the mounting slots on the base with the mounting posts on the wall. Then push in and down until the phone is firmly seated.
- 9) On the base unit, pull the handset retainer out of the slot. Rotate it clockwise 180 degrees.
- 10) Flip the retainer from front to back. Slide it back into the slot so that the lip of the retainer is up and the oval is down. The retainer holds the handset in place.

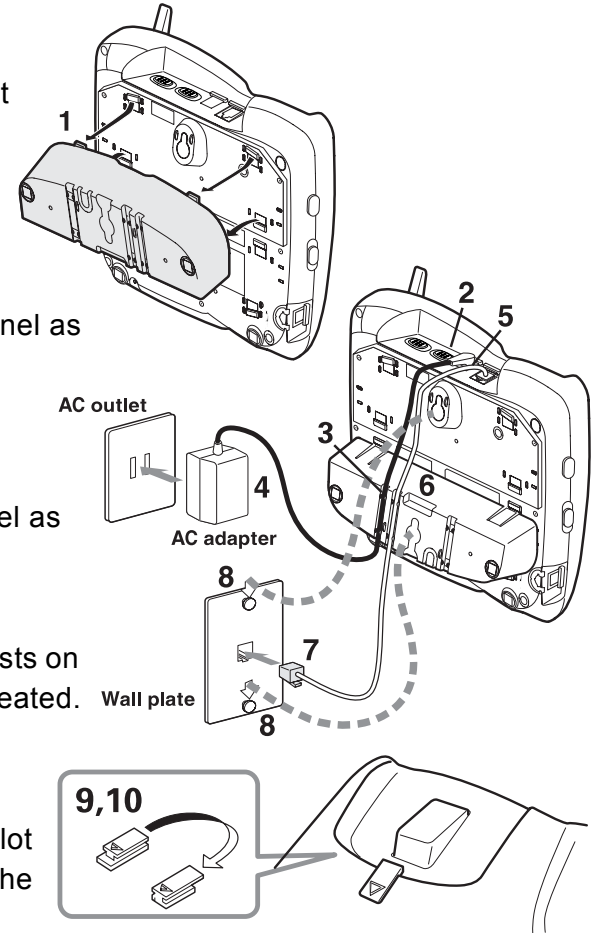

Direct Wall Mounting

If you don't have a standard wall plate, you can mount your phone directly to the wall. Before doing this, consider the following:

- Avoid electrical cables, pipes, or other items behind the mounting location that could cause a hazard when inserting screws into the wall.
 - Try to mount your phone within 5 feet of a working phone jack to avoid excessive cord lengths.
 - Make sure the wall material is capable of supporting the weight of the base and handset.
 - Use #10 screws (minimum length of 1-3/8 inches) with anchoring devices suitable for the wall material where the base unit will be placed.
- 1) Insert two mounting screws into the wall, (with their appropriate anchoring device), 3-15/16 inches apart. Allow about 1/8 of an inch between the wall and screw heads for mounting the phone.
 - 2) Refer to steps 1 through 10 on page 15 to mount the telephone.

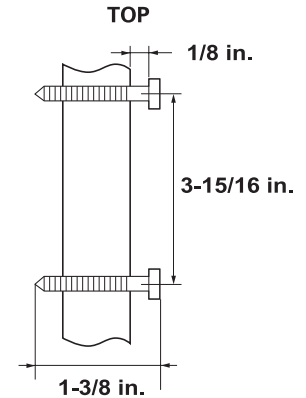

Connecting the Cordless Handset and Charger

The cordless handset is powered by a rechargeable battery pack. The battery recharges automatically when the handset is placed in the charger.

- 1) Connect the AC adapter to the **DC IN 9V** jack and to a standard 120V AC wall outlet.

CAUTION: Use only the Uniden AD-310 AC adapter.

- 2) Set the charger on a desk or tabletop, and place the handset in the charger with the keypad facing forward.
- 3) Make sure that the **charge** light illuminates. If the **charge** light does not illuminate, check to see that the AC adapter is plugged in and the handset makes good contact with the charging contacts.
- 4) Charge the handset battery pack for at least 15-20 hours before using your new cordless handset for the first time.
- 5) To test your connection, try making a call from the cordless handset. If your call does not connect, check to make sure the battery is fully charged. If you see **LOW BATTERY** on the cordless handset display, check to make sure the battery is properly connected. To check the battery, slide the battery compartment door open and check the battery cables to ensure a tight and proper connection. If your handset still does not work, please contact Uniden's Customer Service department. Please see back cover for contact information.

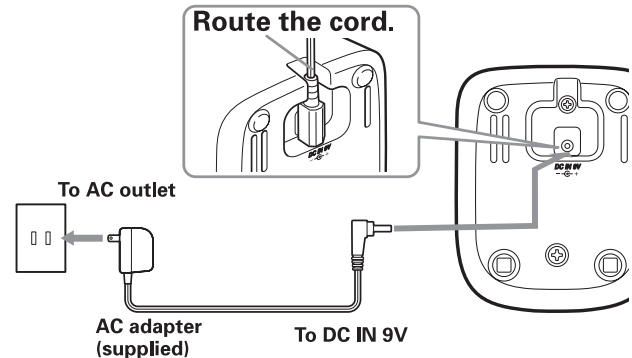

Installing the Beltclip

Line up the holes on each side of the cordless handset. To attach the beltclip, insert into the holes on each side of the handset. Press down until it clicks.

To remove the beltclip, pull either side of the beltclip to release the tabs from the holes.

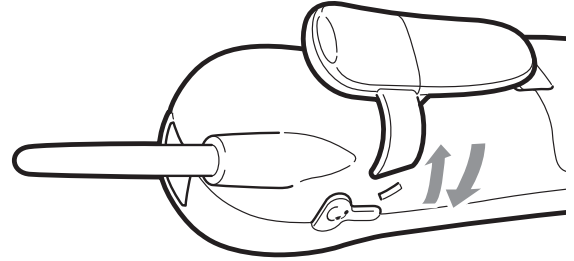

Installing the Optional Headset

Your cordless handset may be used with an optional headset. To use this feature, insert the headset plug into the headset jack. Your phone is ready for hands-free conversations. Headsets may be purchased by calling the Uniden Parts Department. See the back cover page for contact information.



Base Setup

Selecting a Language for your Answering Machine and Base Display

You can set the language of your base menu display and answering machine announcements to English, French, or Spanish.

- 1) Press **[menu/set]** on the base.
- 2) Press **[select/-]** to move the pointer to select LANGUAGE, and then press **[menu/set]**.
- 3) Press **[select/+]** or **[select/-]** to choose ENGLISH, FRANÇAIS (French), or ESPAÑOL (Spanish).
- 4) Press **[menu/set]**. You will hear a confirmation tone.

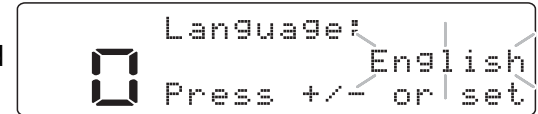

Setting the Day and Time

To set the day and time on your phone, do the following:

- 1) Press **[menu/set]** on the base.
- 2) Press **[menu/set]** to select TIME. The system announces "Time", the current time and the voice guidance for setting the time.
- 3) Press **[select/+]** or **[select/-]** to select the day of the week, and then press **[menu/set]**.
- 4) Enter a two-digit number (**01-12**) to set hour, and then press **[menu/set]**.
- 5) Enter a two-digit number (**00-59**) to set minute, and then press **[menu/set]**.

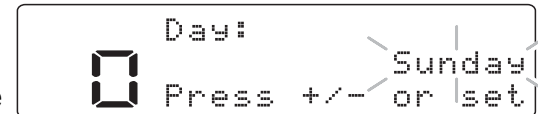

- 6) Press **[select/+]** or **[select/-]** to choose AM or PM, and then press **[menu/set]**. You will hear a confirmation tone.

Note: Use **[Ø]** (delete) to edit the hour and minute.

Adjusting the Base Display (LCD Contrast)

You can adjust the contrast or brightness of the text that appears on your base display. Choose one of ten levels for optimum viewing.

- 1) Press **[menu/set]** on the base.
- 2) Press **[select/-]** to move the pointer to select LCD CONTRAST and then press **[menu/set]**.
- 3) Press **[select/+]** or **[select/-]** to adjust the contrast of the base display.
- 4) Press **[menu/set]**. You will hear a confirmation tone.



Setting the Area Code

If in your local calling area you can make a local call by dialing only 7 digits (instead of 10), you can program your local area code in your phone. Calls that come from within your area code will show only the 7-digit phone number; calls from outside your area code will show all 10 digits. To enter an area code, follow the steps below:

- 1) Press **[menu/set]** on the base.
- 2) Press **[select/-]** to move the pointer to select AREA CODE, and then press **[menu/set]**.
- 3) Press the number keypad **[0-9]** to enter a 3-digit area code.

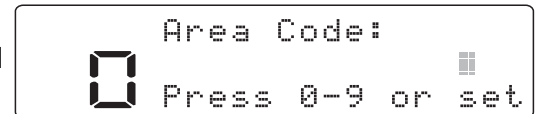

- 4) If you press **[menu/set]**, the stored number will be transferred to the cordless handset. If the transfer is successful, you will hear a confirmation tone from the base and cordless handset. Otherwise, AREA CODE SETTING FAILED! appears on the display and an error tone sounds. You will have to start over with the procedure you are performing.

Note: If the area code has already been stored in memory, the stored area code will be displayed. To change it, use **[Ø]** (delete) and the number keys to enter the new area code.

Setting Caller ID on Call Waiting (CIDCW)

Caller ID on Call Waiting (CIDCW) displays the name and number of an incoming call while you are on the line.

- 1) Press **[menu/set]** on the base.
- 2) Press **[select/-]** to move the pointer to select CIDCW, and then press **[menu/set]**.
- 3) Press **[select/+]** or **[select/-]** to select ON or OFF, and then press **[menu/set]**. You will hear a confirmation tone.

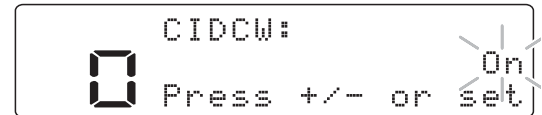

Handset Setup

Selecting a Language for the Handset Display

You can change the language the cordless handset will display. Choose from ENGLISH, FRENCH, or SPANISH.

- 1) Press **[menu]** on the cordless handset.
- 2) Press **[volume/Δ/-]** to move the pointer to select LANGUAGE.

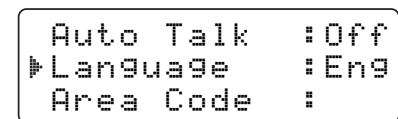

- 3) Press **[select/intercom]** to toggle between ENG (English), FR. (French) and ESP (Spanish).
- 4) Press **[menu]** to complete the setting. The handset returns to standby.

Setting AutoTalk

AutoTalk allows you to answer the phone simply by removing the cordless handset from the cradle. You do not have to press any keys to answer the call.

- 1) Press **[menu]** on the cordless handset.
- 2) Press **[select/intercom]** to turn AutoTalk on.
- 3) Press **[menu]** to complete the setting. The handset returns to standby.

```
▶ Auto Talk    : Off
  Language     : Eng
  Area Code    :
```

Checking the Area Code Setting from the Handset

If you have set a default area code in your base phone, your cordless handset will default to the same area code setting. You can only check the Area Code number you have set. If you want to enter or edit the number, you will have to use the base to modify. Please refer to *Setting the Area Code* on page 20.

- 1) Press **[menu]** on the cordless handset.
- 2) You can check the number entered in Area Code.
- 3) Press **[menu]**. The handset returns to standby.

```
▶ Auto Talk    : Off
  Language     : Eng
  Area Code    : 345
```

Emergency Dialing From the Base & Cordless Handset

Your corded base phone and cordless handset comes with a special Emergency Speed Dial [+] key that is already pre-programmed to dial 911 when pressed.

This key can be re-programmed with another special emergency dial number of your choice by following these steps:

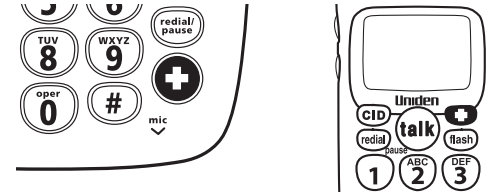

- 1) With the phone in standby, press and hold the Emergency Dial [+] key on the base or the cordless handset. If the Emergency Dial number is already programmed, the Edit screen appears. You can select EDIT NUMBER to edit this entry, select DELETE NUMBER to erase this entry or select GO BACK to return to the previous screen.
- 2) Store the number by following step 6 under *Storing Names and Numbers for Speed Dialing* on page 27.
- 3) Press [menu/set] on the base or [select/intercom] on the handset. You will hear a confirmation tone, and NUMBER STORED appears. Memory storage is complete.

Note:

- When editing the Emergency Dial number, you must press a key within 30 seconds or the phone will return to standby.
- The Emergency Dial number can be up to 48 digits on the base and up to 20 digits on the handset.
- When [+] on the base is pressed, base visual ringer tells you by flashing.
- If you press [+] accidentally, press [talk] on the same station to cancel the dialing.

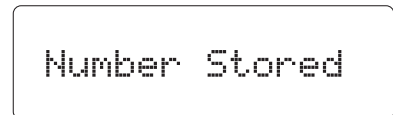
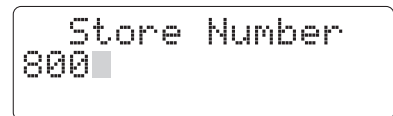
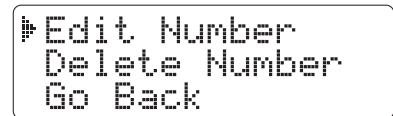
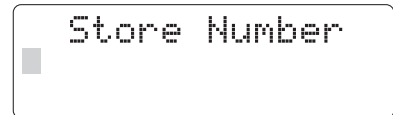

One-touch Speed Dialing from the Base

The base has 4 one-touch speed dial locations ([A], [B], [C] and [D]) that can be programmed for special or frequently dialed numbers. Use the following steps to set up these speed dial numbers:

- 1) With the base in standby, press and hold [A], [B], [C] or [D].
If the key already has a number programmed, the Edit screen appears. You can select EDIT NUMBER to edit this entry, select DELETE NUMBER to erase this entry or select GO BACK to return to the previous screen.

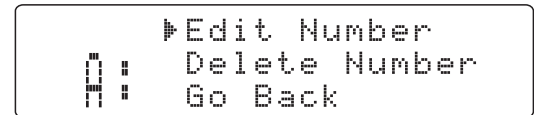
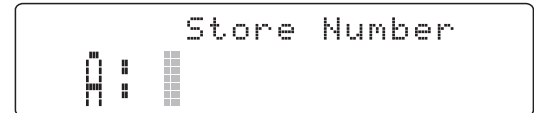

- 2) Store the number by following step 6 under *Storing Names and Numbers for Speed Dialing* on page 27.

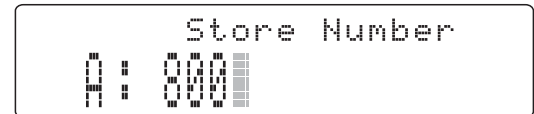

- 3) Press [menu/set] on the base. You will hear a confirmation tone, and NUMBER STORED appears. Memory storage is complete.

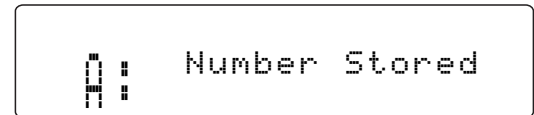

Note:

- When editing these Speed Dial numbers, you must press a key within 30 seconds or the phone will return to standby.
- The One-touch Speed Dial number can be up to 48 digits.

To make a call from a one-touch speed dial, simply press one of the one-touch speed dial keys [A-D], and your phone will automatically dial the number.

Speed Dialing from the Cordless Handset

Your cordless handset allows you to store up to 10 names and numbers for quick and easy dialing of frequently called numbers.

These 10 speed dials are not limited to just phone numbers. You can store any number (up to 20 digits) that you need to enter once your call connects. This is referred to as **Chain Dialing**. For example, you can save your bank account number to a speed dial. When you call your bank's telephone teller service and are prompted to enter your account number, simply press **[memory]** and the speed dial number where you stored your account number. Then press **[select/intercom]**. Or you can save and store prescription drug information for fast and easy reordering with your pharmacy.

Note: When editing a Speed Dial, you must press a key within 30 seconds or the phone will return to standby.

Storing Names and Numbers for Speed Dialing

- 1) With the phone in standby, press **[memory]**.
- 2) Enter **[0-9]** to select the speed dial number where you would like to store this entry. You can also scroll through the list with **[volume/▲/+]** or **[volume/▲/-]**. Press **[select/intercom]**.
- 3) STORE NAME appears and a cursor flashes indicating that the display is ready for the name to be entered.



```
Select Memory
1 [Empty]
2 JOHN DOE
```



```
Store Name
```

If the selected speed dial number is already assigned, the Edit screen appears. You can select MAKE A CALL to dial the number, select EDIT MEMORY to edit this entry, select DELETE MEMORY to erase this entry, or select GO BACK to choose another speed dial number.

```
# Make a Call
Edit Memory 1
Delete Memory 1
```

4) Enter a name according to the instructions below.

- The name can be up to 14 characters.
- Use **[*/tone/←]** and **[#/→]** to move the cursor to the desired location.
- Use **[delete/channel]** to delete characters as needed.
- Press and hold **[delete/channel]** to delete all the characters.
- If no name is required, go to step 5.

Refer to the letters on the number keys to select the desired characters.

Each time you press a numeric key, the displayed character appears in the following order: Upper case letters first, lower case letters next and finally the number corresponding to the key.

If you make a mistake while entering a name

Use **[*/tone/←]** or **[#/→]** to move the cursor to the incorrect character.

Press **[delete/channel]** to erase the wrong character. Then enter the correct character. To delete all characters, press and hold **[delete/channel]**.

For example, to enter **Movies**:

- 1) Press **[6]** once to enter **M**.
Then press **[#/→]** to move the cursor to the right.
- 2) Press **[6]** six times to enter **o**.
- 3) Press **[8]** six times to enter **v**.
- 4) Press **[4]** six times to enter **i**.
- 5) Press **[3]** five times to enter **e**.
- 6) Press **[7]** eight times to enter **s**.

| | Number of times key is pressed | | | | | | | | |
|---------------|--------------------------------|---|---|---|---|---|---------|---|---|
| keys | 1 | 2 | 3 | 4 | 5 | 6 | 7 | 8 | 9 |
| 1 | 1 | | | | | | | | |
| 2 ABC | A | B | C | a | b | c | 2 | | |
| 3 DEF | D | E | F | d | e | f | 3 | | |
| 4 GHI | G | H | I | g | h | i | 4 | | |
| 5 JKL | J | K | L | j | k | l | 5 | | |
| 6 MNO | M | N | O | m | n | o | 6 | | |
| 7 PQRS | P | Q | R | S | p | q | r | s | 7 |
| 8 TUV | T | U | V | t | u | v | 8 | | |
| 9 WXYZ | W | X | Y | Z | w | x | y | z | 9 |
| 0 oper | * | # | - | & | (|) | (blank) | 0 | |

- 5) Press **[select/intercom]**. STORE NUMBER is displayed. The cursor flashes indicating that the display is ready for the number to be entered.

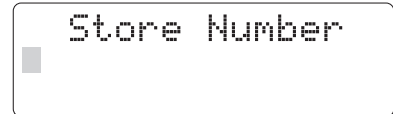

- 6) Use the keypad to enter the phone number; each number can be up to 20 digits. If you need the phone to pause during the dialing sequence, press **[redial/pause]** to insert a two-second pause between the numbers. You can enter multiple pauses to increase the delay. Each pause counts as a digit. The display shows a P for every pause.

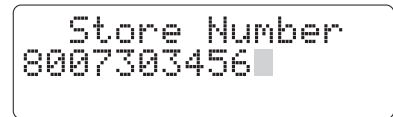

Note: If the next character uses the same number key, you must press **[#/→]** to move the cursor over. Otherwise the next time you press the number key, it changes the character that was previously set.

7) Press **[select/intercom]**. You will hear a confirmation tone.

```
Memory 1 Stored
```

8) After about 2 seconds, the speed dial entries will appear.

```
1# Movies  
2 JOHN DOE  
3 MOM AND DAD
```

9) Press **[memory]** to exit memory setup mode. The phone returns to standby.

Storing Caller ID Information to Speed Dial Locations

Caller ID names & numbers shown in the Caller ID list can be stored to a speed dial location.

For instructions on viewing the Caller ID information, see page 42. If the Caller ID information did not include the phone number, then you will not be able to store it.

Follow these steps to store a Caller ID name and number to a speed dial location:

1) Press **[CID]**. Select the phone number to be stored from the Caller ID list by pressing **[volume/▲/+]** or **[volume/▲/-]**.

```
5/17 12:30PM 03  
Jane Smith  
214-555-1234
```

2) Press **[memory]**.

```
Select Memory  
1# <Empty>  
2 JOHN DOE
```

- 3) Enter a number **[0-9]** or press **[volume/Δ/+]** or **[volume/Δ/-]** to select the memory location to be stored.
- 4) Press **[select/intercom]**. You will hear a confirmation tone, and the number is stored in memory. The display returns to the Caller ID data.

```
5/17 12:30PM
Jane Smith
214-555-1234
```

Note: If a message has already been stored in the selected memory number location, a confirmation screen is displayed. Press [volume/Δ/+] to select YES. Press [select/intercom] to overwrite. The display returns to the Caller ID data.

```
Replace Memory?
Yes
No
```

Using Your Phone

During a Power Failure

Because the phone is a corded/cordless combination phone, it can still perform several of its functions during a power failure. The following features will function with base corded handset even during a power failure:

- Making and receiving calls with the base corded handset
- Using your Emergency Dial **[+]** key after picking up the base corded handset
- Using your one-touch speed dial **[A-D]** keys after picking up the base corded handset
- Adjusting the volume (Base corded handset only)
- Call Waiting (Base corded handset only)
- Redialing the last number dialed (Base corded handset only)

All other features are disabled during a power failure.

Making and Receiving Calls

| | From the cordless handset | From the base speakerphone* | From the base corded handset |
|-------------------------|---|--|--|
| Making a call | 1) Pick up the handset from the cradle. 2) Press [talk] . 3) Listen for the dial tone. 4) Dial the number. OR 1) Remove the handset from the cradle. 2) Dial the number. 3) Press [talk] . | 1) Press [talk] . 2) Listen for the dial tone. 3) Dial the number. OR 1) Dial the number. 2) Press [talk] . | 1) Pick up the corded handset. 2) Listen for the dial tone. 3) Dial the number. OR 1) Dial the number. 2) Pick up the corded handset. |
| | Note: To insert a two-second pause in the dialing sequence in standby, press [redial/pause] . A P appears in the display. | | |
| Receiving a call | 1) Pick up the handset from the cradle. (If AutoTalk is on, the phone answers automatically when you pick up the handset from the charging cradle.) 2) Press [talk] . OR If the handset is off the cradle, press [talk] . (If AutoTalk is on, you can press any key in the twelve number keypad.) | Press [talk] . | Pick up the corded handset. |
| Hanging Up | Press [talk] or return the handset to the cradle. | Press [talk] . | Return the corded handset to the base. |

* The base microphone is located under the base. Position yourself as close to the base as possible.

Switching between the Base Speakerphone and Corded Handset During a Call

To switch a call from the corded handset on the base to the base speakerphone, press **[talk]** on the base. To switch from a base speakerphone call to the base corded handset, pick up the corded handset.

Making a Call from the Base Emergency Dial or Speed Dial Locations

Simply press the Emergency Dial **[+]** key or one of the four (4) One-touch Speed Dial **[A-D]** keys on the base, and your phone will automatically dial the number. To cancel, press **[talk]** on the base.

Making a Call from the Handset Emergency Dial or Speed Dial Locations

Simply press the Emergency Dial **[+]** key on the cordless handset and your phone will automatically dial the number. To cancel, press **[talk]** on the cordless handset.

To dial one of the speed dial numbers, simply follow these steps:

- 1) Press **[memory]**. The handset displays your programmed speed dial numbers.
- 2) Enter the number **[0-9]**, or press **[volume/Δ/+]** or **[volume/Δ/-]** to select the speed dial number you would like to dial.
- 3) Press **[talk]** on the handset and the displayed number is dialed.

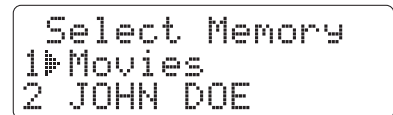

Select Memory
1# Movies
2 JOHN DOE

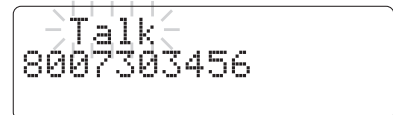

Talk
8007303456

To cancel speed dialing

Press **[talk]** on the handset again to cancel speed dialing. The phone returns to standby. Also, if the phone is idle (e.g., no key is pressed) for 30 seconds, the phone returns to standby.

Easy dialing

If you want to directly access the speed dial location, press and hold **[0-9]** when the handset is in standby, and when the stored number appear, press **[talk]** on the handset.

Making a Call from a Caller ID Listing

You can place a call from the Caller ID list.

- 1) Press **[cid]** on the base or **[CID]** on the cordless handset.
- 2) Select the phone number that you want to dial by pressing **[select/+]** or **[select/-]** on the base, or **[volume/▲/+]** or **[volume/▲/-]** on the handset.
- 3) To have the phone dial a 1 before the displayed Caller ID number for placing a long distance call, press **[1]**. To have the phone dial the stored area code before the displayed Caller ID number, press **[3]**.
- 4) Press **[talk]** on the base or handset or remove the corded handset from the base. The displayed phone number dials automatically.



Note:

- You can also press **[talk]** on the base or handset or remove the corded handset from the base before finding the phone number you want to dial. When you come to the phone number you want to dial, press **[menu/set]** on the base or **[select/intercom]** on the handset.
- You cannot make a call from the Caller ID list if your cordless phone is connected to a private branch exchange (PBX).

Call Waiting

If you subscribe to Call Waiting service, you can receive calls while on the line.

- 1) If a call comes in while you are on the phone, you will hear a call waiting tone. If you have CIDCW activated, you will see the name and number of the incoming caller.

- 2) Press **[flash]** on the base or cordless handset to accept the waiting call. After a short pause, you will hear the new caller.
- 3) To return to the original caller, press **[flash]** on the base or handset again.

Tip: You must subscribe through your local telephone company to receive Call Waiting service.

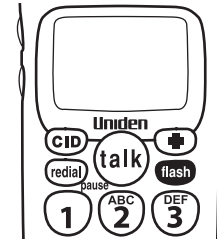
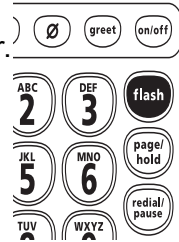

Redialing the Last Number Dialed

| From the cordless handset | From the base speakerphone | From the base corded handset |
|---|---|---|
| <ol style="list-style-type: none"> 1) Pick up the handset from the cradle. 2) Press [talk]. 3) Listen for the dial tone. 4) Press [redial/pause]. <p>OR</p> <ol style="list-style-type: none"> 1) Pick up the handset from the cradle. 2) Press [redial/pause]. 3) Press [talk]. | <ol style="list-style-type: none"> 1) Press [talk]. 2) Listen for the dial tone. 3) Press [redial/pause]. <p>OR</p> <ol style="list-style-type: none"> 1) Press [redial/pause]. 2) Press [talk]. | <ol style="list-style-type: none"> 1) Pick up the corded handset. 2) Listen for the dial tone. 3) Press [redial/pause]. <p>OR</p> <ol style="list-style-type: none"> 1) Press [redial/pause]. 2) Pick up the corded handset. |

Adjusting the Ringer, Earpiece and Speaker Volume

Adjusting the Base Ringer

Ringer on/off: The **ringer on/off** switch allows you to set the base ringer on or off. If you set the switch to off, the base ringer will be silent.

Ringer tone: Press the **ringer tone** button in standby to select one of 7 ring tones.

Ringer volume: The base has ten settings for ringer volume.

- 1) With the phone in standby, press **[select/+]** or **[select/-]**.
- 2) The base will sound the ringer volume at the selected setting and display the new ringer volume.

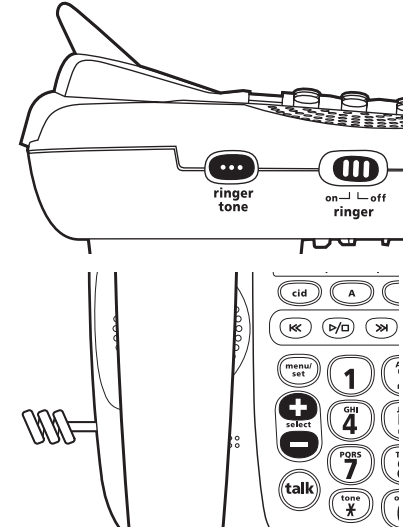

Adjusting the Handset Ring Tone and Volume

Your cordless handset has two different ring tones (A and B) and two different volumes for each (low and high).

- 1) With the phone in standby, press **[volume/▲/+]** or **[volume/▲/-]** to cycle through Ringer A High, Ringer A Low, Ringer B High, Ringer B Low, and Ringer off.
- 2) The phone will sound the different ring tones at different volumes. To turn the ringer off, select Ringer Off.

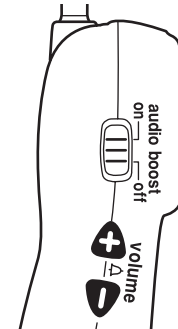

Adjusting the Earpiece and Speaker Volume

Base Speakerphone: You can select eight different volume levels for the base speaker. To adjust the base speaker volume while on a call, press [**select/+**] (to make it louder) or [**select/-**] (to make it softer). This setting will remain in effect after the telephone call has ended.

Base Corded Handset: You can select the earpiece volume from among four volume levels. To adjust the earpiece volume of corded handset while on a call, press [**select/+**] (to make it louder) or [**select/-**] (to make it softer). This setting will remain in effect after the telephone call has ended.

Cordless Handset: You can select the earpiece volume from among four volume levels. To adjust the earpiece volume of cordless handset while on a call, press [**volume/▲/+**] (to make it louder) or [**volume/▲/-**] (to make it softer). This setting will remain in effect after the telephone call has ended.

Temporarily Muting the Base Ringer

To mute the ring tone temporarily for the base, when the phone is ringing, press [**▶/□**] (play/stop) on the base. The mute will last for the current incoming call only. The ring tone will return to the previous setting starting with the next incoming call.

Audio Boost for the Cordless Handset

This feature allows you to hear phone conversations more clearly by boosting the high audio frequency tones.

To set audio boost on, slide the **audio boost on/off** switch upward. BOOST ON appears on the handset display under the volume setting when you start a call. To set audio boost off, slide the **audio boost on/off** switch downward.

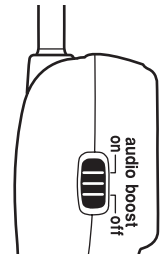

Selecting a Different Channel

If you encounter interference while using your cordless handset, you can manually change the handset's channel for clear operation. While using your handset, press **[delete/channel]**. SCANNING appears on the display, indicating the handset is changing to another channel. For more information on interference, refer to *Radio Interference* on page 66.

Finding the Lost Handset

If you misplace the cordless handset, press **[page/hold]** on the base. The visual ringer on the cordless handset flashes, and the cordless handset will beep for 60 seconds.

To cancel a find handset page, press **[page/hold]** on the base. Paging is also canceled when the phone receives an incoming call.

Placing a Call on Hold from the Base

- 1) During a call from the base, press **[page/hold]**. The call will be put on hold.
- 2) To return to the call, press **[page/hold]** again, pick up the corded handset or press **[talk]** on the base. To talk to the caller from the cordless handset, press **[talk]** on the cordless handset.

Note:

- You can place a call on hold for ten minutes. When ten minutes has passed, the call is disconnected, and the phone automatically returns to standby.
- You can return the corded handset to the base while a call is on hold, and the call will remain on hold.

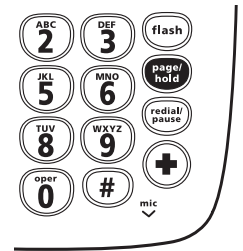

Conferencing

With this phone system, up to three people can participate in a conference call while using an outside line, the cordless handset, and the base.

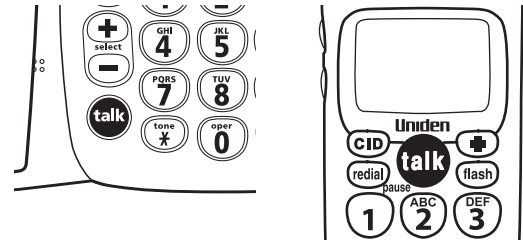

Joining a Conference Call

You can easily join a call already in progress.

| | From the cordless handset | From the base speakerphone | From the base corded handset |
|------------------------------------|--|---|--|
| Joining the conference call | During a call from the base, press [talk] on the handset. | During a call from the cordless handset, press [talk] on the base. | During a call from the cordless handset, pick up the corded base handset. |
| Exiting the conference call | Press [talk] on the handset or return the handset to the cradle. The base will still be connected to the call. | Press [talk] on the base. The cordless handset will still be connected to the call. | Return the corded handset to the base cradle. The cordless handset will still be connected to the call. |

Intercom

The intercom feature lets you communicate between the cordless handset and base without using the phone line. You can make an intercom call while an outside caller is on hold; making an intercom call will not terminate the call on hold. If the party does not answer within one minute, the operation is canceled.

Making an Intercom Page

| | From the cordless handset | From the base speakerphone | From the base corded handset |
|--|---|--|--|
| Making an Intercom Page (in standby) | <p>1) Press [select/intercom].</p> <p>2) The base will be paged. An intercom tone sounds.</p> <p>To cancel the Page: Press [select/intercom] or return the handset to the cradle.</p> | <p>1) Press [page/hold].</p> <p>2) The handset will be paged. An intercom tone sounds.</p> <p>To cancel the Page: Press [page/hold] or [talk].</p> | <p>1) Press [page/hold].</p> <p>2) The handset will be paged. An intercom tone sounds.</p> <p>3) Pick up the corded handset.</p> <p>To cancel the Page: Press [page/hold] or return the corded handset to the base.</p> |
| Making an Intercom Page (During a call) | <p>1) Press [select/intercom].</p> <p>2) The call will automatically be placed on hold, and the paging tone sounds.</p> <p>To cancel the Page: Press [select/intercom] or [talk].</p> | <p>1) Press and hold [page/hold].</p> <p>2) The call will automatically be placed on hold, and the paging tone sounds.</p> <p>To cancel the Page: Press [page/hold] or [talk].</p> | <p>1) Press and hold [page/hold].</p> <p>2) The call will automatically be placed on hold, and the paging tone sounds.</p> <p>To cancel the Page: Press [page/hold].</p> |

Answering and Hanging up an Intercom Page

| | On the cordless handset | With the base speakerphone | With the base corded handset |
|------------------------------------|--|---|--|
| Answering an Intercom Page | 1) Pick up the handset from the cradle. (If AutoTalk is on, the phone answers automatically when you pick up the handset from the charging cradle.) 2) Press [select/intercom] or [talk] . OR If the handset is off the cradle, press [select/intercom] or [talk] . (If AutoTalk is on, you can press any key in the twelve number keypad.) | Press [page/hold] or [talk] . | Pick up the corded handset. |
| Hanging up an Intercom Page | Press [select/intercom] or [talk] . | Press [talk] . | Return the corded handset to the base. |

Transferring a Call

You can transfer a call from one station to another. You may also place a call on hold, intercom page the other station and then transfer the call to that station.

During a call, press and hold **[page/hold]** on the base or press **[select/intercom]** on the cordless handset. To transfer the call, the other station must answer. The station transferring the call may now hang up.

Tone Dialing Switch Over

If your telephone company requires pulse dialing, you can switch to tone dialing after the call connects. This feature is useful when you need tone dialing to use automated menu systems, such as telephone bank tellers, telephone prescription refills, customer support menus, etc.

If your phone is set to pulse dialing, make your call normally. Once your call connects, press **[/tone]** on the base or press **[/tone/←]** on the cordless handset. Any digits you enter from then on will be sent as tone dialing. When this call ends, the phone automatically returns to pulse dialing.

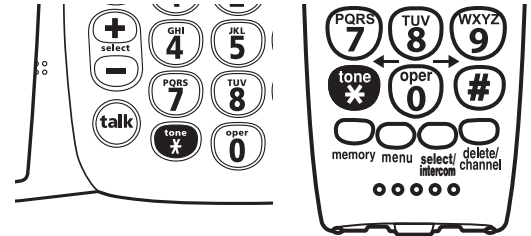

Using Caller ID and Call Waiting

If you subscribe to Caller ID service from your telephone company, your phone will show you the caller's phone number and name (if available) whenever a call comes in. If you subscribe to both Caller ID and Call Waiting, the phone will show you the name and number of any call that comes in while you are on the line.

Caller ID information is stored for up to 50 incoming calls - even unanswered calls. With Caller ID on Call Waiting (CIDCW), you will hear a Call Waiting tone while you are on a call, to accept the waiting call, press **[flash]** on the base or cordless handset (see page 32). Additionally, you can dial a number stored in the Caller ID list or save the information to one of your speed dial locations.

Today US telephone carriers only support the transmission of 15 characters for the Caller ID name; therefore, if someone calls you with a name longer than 15 characters, it will be common for it to be truncated to 15 characters only. Also, you may not receive your caller ID information if you answer the call before the second ring. When you receive a call from a PBX (Private Branch eXchange), the caller's phone number and name may not appear or you may see a common phone number for that PBX system. This is normal operation when receiving caller ID information from a PBX.

Base



Cordless Handset

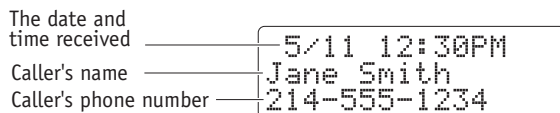

You may receive any one of the following messages:

| | |
|-------------------------------------|-----------------|
| When invalid data is received; | INCOMPLETE DATA |
| When a private name is received; | PRIVATE NAME |
| When a private number is received; | PRIVATE NUMBER |
| When an unknown name is received; | UNKNOWN NAME |
| When an unknown number is received; | UNKNOWN NUMBER |

Note: Data errors will appear on the display as "■."

Using the CID Announce (Base Only)

The CID Announce feature is a **Caller ID that Talks** and verbally announces from the base the name of incoming callers when you receive a call. To use this feature, you must subscribe to Caller ID service from your telephone company and you must have the **CID Announce switch** set to on.

Viewing Caller ID Information

With a Caller ID subscription from your local telephone company, you have two different ways to view Caller ID information. The first way is to look at your cordless handset or base unit when you receive an incoming call. The second is to view your Caller ID history list. To view your CID list, follow these steps:

- 1) With the phone in standby, press **[CID]** on the cordless handset (**[cid]** on the base). The summary screen appears. The screen shows the number of new messages and total messages.
- 2) To view the Caller ID information in historical order (from new to old or from old to new), use **[volume/▲/–]** on the cordless handset (**[select/–]** on the base) to scroll through the data from the latest to the earliest, or **[volume/▲/+]** on the cordless handset (**[select/+]** on the base) to scroll back through the messages.
- 3) To finish viewing the CID information, press **[CID]** on the cordless handset (**[cid]** on the base).



```
Caller ID
New :01
Total:02
```

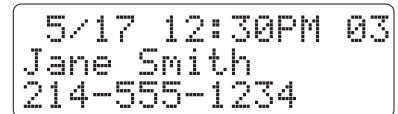

```
5/17 12:30PM 03
Jane Smith
214-555-1234
```

While viewing Caller ID information from your CID list, you may notice that a number will appear next to the received time of some Caller ID information. This indicates the number of times that you have received a call from that number. Once you view the information, the number will be cleared.

While viewing or deleting Caller ID information, if you do not press a key within 30 seconds, an error tone will sound and your phone will return to standby. Also, if you receive an incoming call or intercom page while viewing Caller ID information, your operation will be canceled allowing you to answer the call or intercom page.

Deleting Information from the Caller ID List

The cordless phone stores up to 50 Caller ID names and numbers. If the phone receives the 51st Caller ID, the oldest one in the list is automatically deleted. Individual Caller ID data can also be deleted manually by following these steps:

- 1) Press **[CID]** on the cordless handset (**[cid]** on the base) while in standby.
- 2) Find the message to be deleted from the Caller ID list by pressing **[volume/▲/+]** or **[volume/▲/-]** on the cordless handset (**[select/+]** or **[select/-]** on the base).
- 3) Press **[delete/channel]** on the cordless handset (**[Ø]** (delete) on the base).
- 4) Press **[volume/▲/+]** on the cordless handset (**[select/+]** on the base) to select YES, and then press **[select/intercom]** on the cordless handset (**[menu/set]** on the base).

You will hear a confirmation tone.

```
Caller ID
New :01
Total:02
```

```
5/17 12:30PM 03
Jane Smith
214-555-1234
```

```
Delete Message?
# Yes
No
```

To Delete the entire Caller ID List:

- 1) Press **[CID]** on the cordless handset (**[cid]** on the base) while in standby.
- 2) Press **[delete/channel]** on the cordless handset (**[Ø]** (delete) on the base).
- 3) Press **[volume/Δ/+]** on the cordless handset (**[select/+]** on the base) to select YES, and then press **[select/intercom]** on the cordless handset (**[menu/set]** on the base).

You will hear a confirmation tone and all Caller ID information is deleted.

```
Caller ID  
New :01  
Total:02
```

```
Delete All?  
▶ Yes  
No
```

```
Caller ID  
Total:00
```

Setting Up the Answering Machine

The phone has a built-in answering machine that answers and records incoming calls.

You can also use your system to announce a special outgoing message to callers when you are away from your phone.

Features

- Digital Tapeless Recording
- Up to 15 minutes of Recording Time
- Call Screening
- Personal or Pre-recorded Outgoing Messages
- Trilingual Display and Voice Prompts (English, Spanish, or French)
- Time and Day Announcement
- Remote Message Retrieval
- Toll Saver
- Message Alert

Selecting a Language

You can set the language of your base menu display and answering machine announcements to English, French, or Spanish. To select your language choice, please refer to *Selecting a Language for your Answering Machine and Base Display* on page 19 under *Base Setup*.

Setting the Record Time (or Announce Only)

You can select how long a caller has to record a message. You have three record time options. The options 1 MINUTE or 4 MINUTES set the duration for recording the incoming messages. ANNOUNCE ONLY answers the call and plays either your personal greeting or the pre-recorded system greeting, but prevents the caller from leaving a message.

- 1) Press **[menu/set]** on the base.
- 2) Press **[select/-]** to move the pointer to select RECORD TIME, and then press **[menu/set]**.
- 3) Press **[select/+]** or **[select/-]** to select Record Time 1 MINUTE, 4 MINUTES, or ANNOUNCE ONLY.
- 4) Press **[menu/set]**. You will hear a confirmation tone.

Note:

- For your convenience, voice prompts will guide you through the menus.
- Press **[▶/□]** (play/stop) on the base to return to standby.
- If you do not press a key within 30 seconds, the phone will time out and exit the menu.

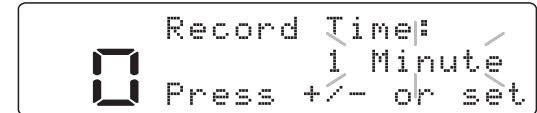

Activating Call Screening

Your phone allows you to listen to callers leaving you a message. This feature can be turned on or off with the following steps:

- 1) Press **[menu/set]** on the base.
- 2) Press **[select/-]** to move the pointer to select CALL SCREENING, and then press **[menu/set]**.

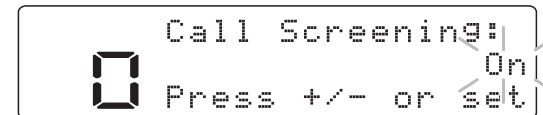

- 3) Press **[select/+]** or **[select/-]** to select ON or OFF.
- 4) Press **[menu/set]**. You will hear a confirmation tone.

Setting the Number of Rings

The ring time setting allows you to set the number of rings the caller hears before your answering machine plays the outgoing message. You can set the ring time to answer after two, four, or six rings. If you enable the Toll Saver, the answering machine picks up after two rings if you have new messages and after four rings if there are none.

- 1) Press **[menu/set]** on the base.
- 2) Press **[select/-]** to move the pointer to select RING TIME, and then press **[menu/set]**.
- 3) Press **[select/+]** or **[select/-]** to select a Ring Time (TOLL SAVER, 2 TIMES, 4 TIMES, or 6 TIMES).
- 4) Press **[menu/set]**. You will hear a confirmation tone.

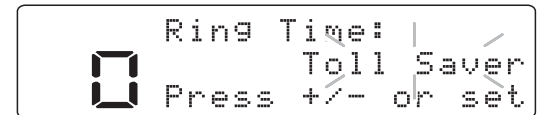

Activating the Message Alert

The Message Alert feature sounds a short alert tone every 15 seconds whenever you have a new message. Once all new messages have been played, the alert tone automatically stops beeping until you receive another new unplayed message.

- 1) Press **[menu/set]** on the base.
- 2) Press **[select/-]** to move the pointer to select MESSAGE ALERT, and then press **[menu/set]**.

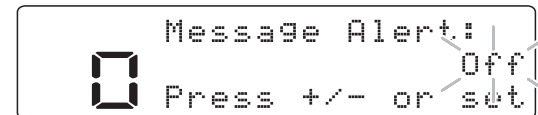

- 3) Press **[select/+]** or **[select/-]** to select ON or OFF.
- 4) Press **[menu/set]**. You will hear a confirmation tone.

To quickly turn off the Message Alert tone, press any key on the base unit; the tone will automatically quiet until you receive another new message.

Setting Your Greeting

When you receive a call, the answering machine automatically plays either the pre-recorded message or your own greeting. Your answering machine comes with the following pre-recorded message:

"Hello, no one is available to take your call. Please leave a message after the tone."

Or you can record your own personal outgoing greeting. Your recorded greeting must be between 2 seconds and 30 seconds long. Once you have recorded a personal greeting, you can switch back and forth between the pre-recorded greeting and your own personal greeting.

To Record a Personal Greeting:

- 1) Press **[greet]**. While the pre-recorded message is playing, press and hold **[greet]** again. You will hear the announcement "Record greeting" and a confirmation tone.

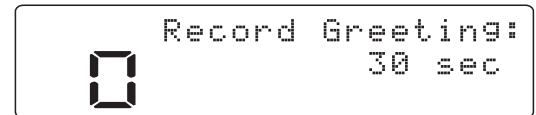

If you already have a greeting recorded, you can delete the current one and then record a new greeting. While the current greeting is playing, press **[Ø]** (delete). And then start over with the first.

- 2) Start recording your message. You will have 30 seconds, and the message counter will count down. When you are finished recording your greeting, press **[greet]**, **[▶□]** (play/stop) or **[menu/set]**. You will hear a confirmation tone, and then your greeting plays back for you.

Note:

- **Position yourself as close to the base as possible and speak clearly when recording your greeting.**
- **If you make an outside call or a call is received during the new greeting recording, the operation is canceled.**
- **The greeting must be more than two seconds long, or it will not be recorded.**
- **To delete the personal greeting, press [∅] (delete) while the message is playing. The system announces "Greeting has been deleted."**

Selecting Your Greeting

You can switch back and forth between your personal greeting and the pre-recorded system greeting. With the phone in standby, press **[greet]**. Then press **[greet]** again while the outgoing greeting is played. This switches between the prerecorded greeting and the personal greeting. After your greeting selection plays back, a confirmation tone is heard.

Setting a Security Code or Personal Identification Number (PIN)

To play your messages from a remote location outside of your home, you will need to enter a two-digit Security code or Personal Identification Number (PIN).

- 1) Press **[menu/set]** on the base.
- 2) Press **[select/-]** to move the pointer to select SECURITY CODE, and then press **[menu/set]**.

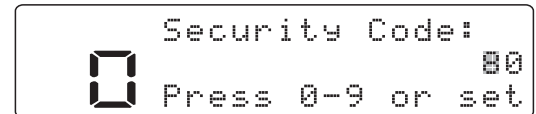

- 3) Enter a two-digit Security or PIN code (**01-99**) using the number keypad. To change the number, use [**Ø**] (delete) to backspace.
- 4) Press [**menu/set**]. You will hear a confirmation tone.

Using Your Answering Machine

The message counter on the base display will show the number of messages you have waiting. If **NEW** appears in the base display and flashes, you have new messages waiting that you have not yet listened to. The answering machine will play all of your new messages first and then play any old messages that you have not yet deleted from the system.

Turning your Answering System On & Off

| Turning On | Turning Off |
|---|--|
| <ol style="list-style-type: none"> 1) With the phone in standby, press [on/off] on the base. 2) The system announces "Answering System is on" and plays the current greeting. 3) The answer on/off light will be illuminated. If the answer on/off light flashes, then you have new messages waiting. | <ol style="list-style-type: none"> 1) With the phone in standby, press [on/off] on the base. 2) The system announces "Answering System is off". 3) The answer on/off light will no longer be illuminated. |

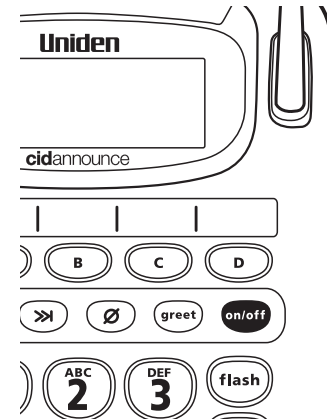

Note: When the answering machine is full, **FL** appears on the base display. You should delete some messages so that the system can record new messages.

Reviewing Messages

The base display indicates the number of messages you have waiting. When you have new messages, the **answer on/off** light on the base will flash and NEW will appear in the base display and flash. The answering machine plays your new messages first. After you listen to all of your new messages, you can then play your old messages.

To review your messages from the base:

| | |
|----------------------------------|--|
| Playing messages | With the phone in standby, press [▶/□] (play/stop). The system announces the number of new and old messages. It announces the message number, plays the message, then announces the time and date it was received. |
| Repeating a message | Press [<<] (repeat/rewind) once to go to the beginning of the current message. Press [<<] (repeat/rewind) repeatedly to go back to a previous message. Press and hold [<<] (repeat/rewind) to rewind through the current message. |
| Skipping a message | Press [>>] (skip/forward) to go to the beginning of the next message. Press and hold [>>] (skip/forward) to fast forward through the current message. |
| Deleting a message | While a message is playing, press [Ø] (delete). The message is permanently deleted. |
| Deleting all messages | While the phone is in standby, press [Ø] (delete). When the system asks you to confirm, press [Ø] (delete) again. All messages are permanently deleted. |
| Ending the message review | Press [▶/□] (play/stop) at any time to stop the message playback and return to standby. The message counter shows the number of messages stored in memory. |

Note: You can not delete unheard messages. If you try to delete messages before listening to them, the answering machine will beep and say "Please playback all messages."

Screening Calls

Your phone allows you to listen to callers leaving a message without answering the phone. You can always hear callers from the base speaker. To screen an incoming call, make sure your phone has Call Screening activated. To activate this feature, please see page 46.

- To adjust the volume, press **[select/+]** or **[select/-]** on the base.
- To answer the call, pick up the corded handset or press **[talk]** on the base.
- To mute the Call Screen, press **[▶/□]** (play/stop).
- To cancel muting, press **[select/+]** or **[select/-]**.
- If you turn the answering system off, you cannot screen a call.

Remotely Operating Your Answering Machine

You can access your answering machine while you are away from home to check, play, delete messages or even record a new greeting or turn your answering machine on and off. Once you enter the remote access menu, you must enter a command within 15 seconds, or the system automatically hangs up and returns to standby. For your convenience remote operation cards, located on page 72, are provided for you to use while away from home.

To remotely operate your answering machine from any touch-tone telephone:

- 1) Call your telephone number.
- 2) During the greeting, press **[0]** and enter your PIN code (see *Setting a Security Code or Personal Identification Number (PIN)* on page 49).
- 3) The system announces the current time and the number of messages stored in memory. Then you hear "To play incoming messages, press zero two. For help, press one zero."

4) You may continue to listen to the voice prompts, or you may select a command from the following chart:

| Command | Function | Command | Function |
|--------------|------------------------|--------------|-------------------------------|
| [0] then [1] | Repeat a Message | [0] then [6] | Answering System On |
| [0] then [2] | Play incoming Messages | [0] then [7] | Memo Record/Stop* |
| [0] then [3] | Skip a Message | [0] then [8] | Greeting Message Record/Stop* |
| [0] then [4] | Delete a Message | [0] then [9] | Answering System Off |
| [0] then [5] | Stop Operation | [1] then [0] | Voice Prompts |

* For Memo Record and Greeting Message Record, the first time you enter the corresponding command, it starts the recording automatically. If you want to stop the recording, enter the command again.

- 5) After all of the voice prompts have been played, you will hear intermittent beeps indicating that the system is in the command waiting mode. You may enter another command at this time from the chart.
- 6) When you are finished, hang up to exit. The system automatically returns to standby.

Note:

- **If you enter an incorrect security code three times, you will hear a beep and the system will return to standby.**
- **The voice memo messages are recorded as incoming messages.**
- **When the answering system is full, you cannot record a voice memo message until you clear some messages from the memory.**

Maintenance

Specifications

| | | | |
|------------------------------|--|---------------------|------------------------|
| Operation Temperature | -10°C to +50°C (+14°F to +122°F) | | |
| AC Adapter | | For the Base | For the Charger |
| | Part Number | AD-1007 | AD-310 |
| | Input Voltage | 120V AC, 60Hz | 120V AC, 60Hz |
| | Output Voltage | 9V DC @500mA | 9V DC @210mA |
| Handset Battery | Part Number | BT-905 | |
| | Capacity | 600mAh, 3.6V DC | |
| Frequency | 925.181424 - 927.451379 MHz 5739.320225 - 5746.130091 MHz | | |

Note: To avoid damage to the phone use only Uniden AD-1007, AD-310 and BT-905 with your phone.

Power Failure

During a power failure, you can make and receive calls with the base corded handset; however, you will not be able to use the base speakerphone or the cordless handset. The following features are available with the base corded handset during a power failure:

- Corded Volume Control
- Emergency Key
- 4 One-touch dial Keys
- Redial
- Pause
- Flash
- A special ring tone will sound during a power failure and you will not be able to control the volume setting of this ring.

Battery Life

With average use, your battery talk time will be approximately 5 hours and standby time will be approximately 10 days. For optimum performance, be sure to return the cordless handset to the charging cradle after each call. If the cordless handset is left off of the charger, the actual talk time duration will be reduced respective to the amount of time the handset is off the cradle.

Note: Do not place the power cord where it creates a trip hazard or where it could become chafed and create a fire or electrical hazard.

Low battery alert

When the battery pack is very low, the cordless handset is programmed to eliminate functions in order to save power. The battery pack needs to be charged when the cordless handset shows LOW BATTERY CHARGE HANDSET. None of the cordless handset keys will operate until the cordless handset is fully charged. If you are on a call and LOW BATTERY appears, complete your conversation as quickly as possible, and return the handset to the charger.



Low Battery
Charge Handset

Battery Replacement and Handling

With normal use, your cordless phone's battery should last approximately one year. To order replacement batteries or adapters, please contact Uniden's Parts department. Please see the back cover page for contact information.

Note: When replacing batteries, the information stored in the phone's memory will only be retained for 30 minutes after the battery pack is removed. This includes volume, ringer tone and last number dialed. You will want to replace the battery as quickly as possible in order to avoid losing your cordless handset settings.

Warning: To avoid the risk of personal injury or property damage from fire or electrical shock, only use the Uniden battery model and Uniden adapter model specifically designated for this product.

Caution:

- Use only the specified Uniden battery pack (BT-905).
- Do not remove the batteries from the handset to charge it.
- Never throw the battery into a fire, disassemble, or heat it.
- Do not remove or damage the battery casing.

Installing the Rechargeable Battery for Cordless Handset

- 1) Press down on the cordless handset battery case cover (use the finger indentation for a better grip) and slide the cover downward to remove.
- 2) Plug the battery pack connector (red & black wires) into the jack inside the battery compartment. (The connector notches fit into the grooves of the jack only one way.) Match the wire colors to the polarity label in the battery compartment, connect the battery and listen for a click to insure connection.
- 3) Make sure you have a good connection by slightly pulling on the battery wires. If the connection is secure, the battery jack will remain in place.
- 4) Place the battery case cover back on the handset and slide it upwards until it clicks into place.

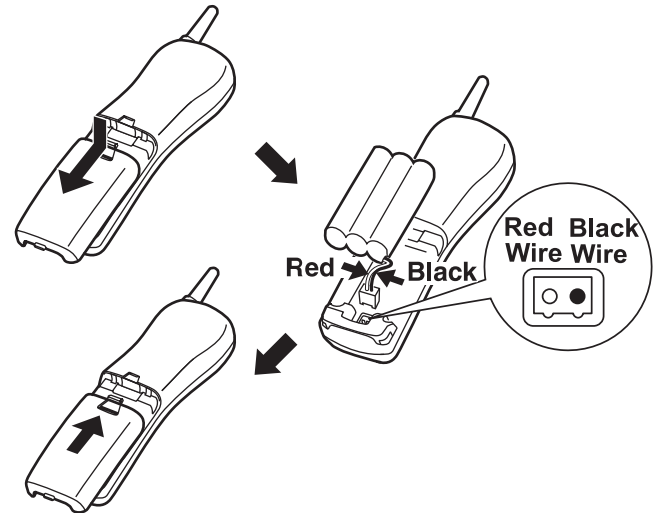

Note: Use only the Uniden BT-905 rechargeable battery pack supplied with your cordless telephone.

Cleaning the Battery Charging Contacts

To maintain a good charge, clean the charging contacts on both the cordless handset and charger once a month. Dampen a cloth with plain water. Gently rub the damp cloth over the charging contacts until all visible dirt is removed. Dry the contacts thoroughly before returning the handset to the cradle.

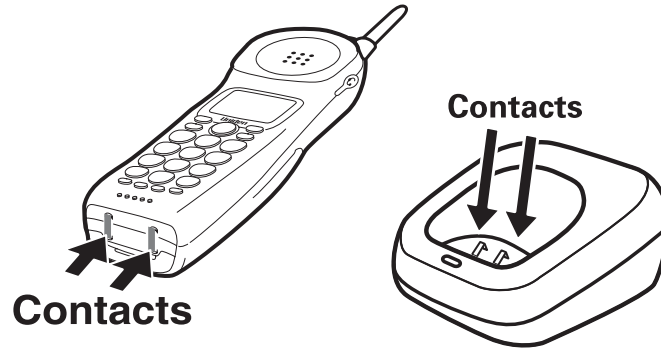

Caution:

Do not use paint thinner, alcohol, or other chemical products.

Doing so may discolor the surface of the telephone and damage the finish.

Troubleshooting

Traveling Out of Range

During a call, if you move your cordless handset too far away from your base, noise may increase. If you pass the range limits of the base, your call will terminate within one minute.

Common Issues

If your phone is not performing to your expectations, please try these simple steps first. If these steps do not solve your problem, please call our Customer Service Hotline. Please see the back cover page for contact information.

| Symptom | Suggestion |
|---|--|
| The charge light won't illuminate when the cordless handset is placed in the cradle. | <ul style="list-style-type: none">• Make sure the AC adapter is plugged into the cradle and wall outlet.• Make sure the cordless handset is properly seated in the cradle.• Make sure the charging contacts on the cordless handset and charger are clean. |
| The audio sounds weak and/or scratchy. | <ul style="list-style-type: none">• Move the handset and/or base away from metal objects or appliances and try again.• Press [delete/channel] during a call to help eliminate background noise.• Make sure that the cordless handset is not too far from the base. |
| Can't make or receive calls. | <ul style="list-style-type: none">• Check both ends of the telephone cord.• Make sure the AC adapter is plugged into the base and wall outlet.• Disconnect the AC adapter for a few minutes. Then reconnect it.• Make sure that the cordless handset is not too far from the base.• Check the dialing mode used by your telephone company. |

| Symptom | Suggestion |
|--|--|
| During power failure, can't make or receive a call. | <ul style="list-style-type: none"> • Make sure to use corded handset to make or receive a call. • Make sure that telephone cord is firmly connected. |
| The cordless handset doesn't ring or receive an intercom page. | <ul style="list-style-type: none"> • The battery pack may be weak. Charge the battery for 15-20 hours. • The cordless handset may be too far from the base unit. • Place the base unit away from appliances or metal objects. • Check the battery pack to ensure there is a secure connection. • Make sure ringer volume is not set to off. |
| Severe noise interference. | <ul style="list-style-type: none"> • Keep the handset away from microwave ovens, computers, remote control toys, wireless microphones, alarm systems, intercoms, room monitors, fluorescent lights, and electrical appliances. • Move the base to another location or turn off the source of interference. |
| The Caller ID does not display. | <ul style="list-style-type: none"> • The call was answered before the second ring. • The call was placed through a switchboard. • Your Caller ID service may not be active; contact your local telephone service provider. |
| The answering machine does not work. | <ul style="list-style-type: none"> • Make sure the AC adapter is plugged into a wall outlet. • Make sure the answering machine is turned on. |
| The answering machine does not record any messages. | <ul style="list-style-type: none"> • Set the record time to either the one minute or four minute option. • The memory may be full. Delete some or all of the saved messages. |

| Symptom | Suggestion |
|--|---|
| Messages are incomplete. | <ul style="list-style-type: none"> • The incoming messages may be too long. Remind callers to leave a brief message. • The memory may be full. Delete some or all of the saved messages. |
| After a power failure, the outgoing message is deleted. | <ul style="list-style-type: none"> • Record your personal outgoing message again. The default message should remain. |
| No sound on the base speaker during call monitoring or message playback. | <ul style="list-style-type: none"> • Adjust the speaker volume on the base. • Make sure the call screen feature is set to on. |
| Cannot access remote call-in features from another touch tone phone. | <ul style="list-style-type: none"> • Make sure you are using the correct PIN code. • Make sure that the touch-tone phone you're using can transmit the tone for at least two seconds. If it cannot, you may have to use another phone to access your phone. |
| CID Announce feature is not announcing new incoming calls. | <ul style="list-style-type: none"> • Check to make sure the CID Announce switch on the back of the base is set to ON. • Check your base speaker volume to ensure it is loud enough to hear the CID Announce feature. |

Liquid Damage

Moisture and liquid can damage your cordless phone.

- If the handset or base is exposed to moisture or liquid, but only the exterior plastic housing is affected, wipe off the liquid, and use as normal.
- If moisture or liquid has entered the plastic housing (i.e. liquid can be heard in the phone or liquid has entered the handset battery compartment or vent openings on the base), follow the steps below:

| Cordless Handset | Base |
|---|---|
| <ol style="list-style-type: none">1) Remove the battery cover and leave it off for ventilation.2) Disconnect the battery pack. Leave the battery cover off and the battery pack disconnected for at least 3 days.3) Once the handset is completely dry, reconnect the battery pack and the battery cover.4) Recharge the handset's battery pack for 15 to 20 hours before using. | <ol style="list-style-type: none">1) Disconnect the AC adapter from the base, cutting off electrical power.2) Disconnect the telephone cord from the base.3) Let dry for at least 3 days. |

IMPORTANT:

You must unplug the telephone line while recharging the battery packs to avoid charge interruption.

CAUTION:

DO NOT use a microwave oven to speed up the drying process. This will cause permanent damage to the handset, base and the microwave oven. After following these steps, if your cordless telephone does not work, please call our Customer Service Hotline. Please see the back cover page for contact information.

Precautions!

Before you read anything else, please note the following:

Warning!

Uniden America Corporation DOES NOT represent this unit to be waterproof. To reduce the risk of fire, electrical shock, or damage to the unit, DO NOT expose this unit to rain or moisture.

Rechargeable Nickel-Cadmium Battery

Warning

- This equipment contains a rechargeable nickel-cadmium battery.
- Cadmium is a chemical known to the State of California to cause cancer.
- The rechargeable nickel-cadmium battery contained in this equipment may explode if disposed of in a fire.
- Do not short-circuit the battery.
- Do not charge the rechargeable nickel-cadmium battery used in this equipment in any charger other than the one designed to charge this battery as specified in the owner's manual. Using another charger may damage the battery or cause the battery to explode.

Rechargeable Nickel-Cadmium Batteries Must Be Recycled or Disposed of Properly



- Uniden voluntarily participates in an RBRC[®] industry program to collect and recycle nickel-cadmium batteries at the end of their useful life, when taken out of service within the United States.
- The RBRC[®] program provides a convenient alternative to placing used nickel-cadmium batteries into the trash or municipal waste stream, which is illegal in some areas.
- Through the RBRC[®] program, Uniden makes it easy for you to drop off the used battery at local retailers of replacement nickel-cadmium batteries. You may also contact your local recycling center for information on where to return the used battery. Please call 1-800-8-BATTERY for information on Ni-Cd battery recycling in your area. Uniden's involvement in this program is part of its commitment to protecting our environment and conserving natural resources.
- RBRC[®] is a registered trademark of the Rechargeable Battery Recycling Corporation.



The exclamation point within an equilateral triangle is intended to alert the user to the presence of important operating and maintenance (servicing) instructions in the literature accompanying the appliance.

Uniden works to reduce lead content in our PVC coated cords in our products and accessories.

Warning!

The cords on this product and/or accessories contain lead, a chemical known to the State of California to cause birth defects or other reproductive harm. Wash hands after handling.

Important Safety Instructions

When using your telephone equipment, basic safety precautions should always be followed to reduce the risk of fire, electric shock and injury to persons, including the following:

1. Do not use this product near water, for example, near a bath tub, wash bowl, kitchen sink or laundry tub, in a wet basement or near a swimming pool.

2. Avoid using a telephone (other than a cordless type) during an electrical storm. There may be a remote risk of electric shock from lightning.
3. Do not use the telephone to report a gas leak in the vicinity of the leak.
4. Use only the power cord and batteries indicated in this manual. Do not dispose of batteries in a fire. They may explode. Check with local authorities for possible battery disposal instructions.
5. Do not disassemble any component of this product.

SAVE THESE INSTRUCTIONS

CAUTION!

Risk of explosion if battery is replaced by an incorrect type. Dispose of used batteries according to the instructions. Do not open or mutilate the battery, and disconnect the battery before shipping this product.

The FCC Wants You To Know

This equipment complies with Part 68 of the FCC rules and the requirements adopted by the ACTA. On the bottom of this equipment is a label that contains, among other information, a product identifier in the format US:AAAEQ##TXXXX. If requested, this number must be provided to the telephone company.

An applicable Universal Service Order Codes (USOC) certification for the jacks used in this equipment is provided (i.e., RJ11C) in the packaging with each piece of approved terminal equipment. A plug and jack used to connect this equipment to the premises wiring and telephone network must comply with the applicable FCC Part 68 rules and requirements adopted by the ACTA. A compliant telephone cord and modular plug is provided with this product. It is designed to be connected to a compatible modular jack that is also compliant. See installation instructions for details.

The REN is used to determine the number of devices that may be connected to a telephone

line. Excessive RENs on a telephone line may result in the devices not ringing in response to an incoming call. In most but not all areas, the sum of RENs should not exceed five (5.0). To be certain of the number of devices that may be connected to a line, as determined by the total RENs, contact the telephone provider. For products approved after July 23, 2001, the REN for this product is part of the product identifier that has the format US:AAAEQ##TXXXX. The digits represented by ## are the REN without a decimal point (e.g., 03 is a REN of 0.3). For earlier products, the REN is separately shown on the label.

If this equipment causes harm to the telephone network, the telephone company will notify you in advance that temporary discontinuance of service may be required. But if advance notice isn't practical, the telephone company will notify the customer as soon as possible. Also, you will be advised of your right to file a complaint with the FCC if you believe it is necessary. The telephone company may make changes in its facilities, equipment, operations or procedures that could affect the operation of the equipment. If this

happens the telephone company will provide advance notice in order for you to make necessary modifications to maintain uninterrupted service. Please follow instructions for repairing, if any (e.g. battery replacement section); otherwise do not substitute or repair any parts of the device except as specified in this manual. Connection to party line service is subject to state tariffs. Contact the state public utility commission, public service commission or corporation commission for information. This equipment is hearing aid compatible.

Should you experience trouble with this equipment, please contact Uniden customer service at 800-297-1023. If the equipment is causing harm to the telephone network, the telephone company may request that you disconnect the equipment until the problem is resolved.

NOTICE: According to telephone company reports, AC electrical surges, typically resulting from lightning strikes, are very destructive to

telephone equipment connected to AC power sources. To minimize damage from these types of surges, a surge arrestor is recommended. Changes or modifications to this product not expressly approved by Uniden, or operation of this product in any way other than as detailed by the owner's manual, could void your authority to operate this product.

This device complies with part 15 of the FCC rules. Operation is subject to the following two conditions: (1) This device may not cause harmful interference, and (2) This device must accept any interference received, including interference that may cause undesired operation. Privacy of communications may not be ensured when using this phone.

To insure the safety of users, the FCC has established criteria for the amount of radio frequency energy various products may produce depending on their intended usage. This product has been tested and found to comply with the FCC's exposure criteria. For body worn operation,

the FCC RF exposure guidelines were also met when used with the Uniden accessories supplied or designed for this product. Use of other accessories may not ensure compliance with FCC RF exposure guidelines and should be avoided.

Radio Interference

Radio interference may occasionally cause buzzing and humming in your cordless handset, or clicking noises in the base. This interference is caused by external sources such as TV, refrigerator, vacuum cleaner, fluorescent lighting, or electrical storm. Your unit is NOT DEFECTIVE. If these noises continue and are too distracting, please check around your home to see what appliances may be causing the problem. In addition, we recommend that the base not be plugged into a circuit that also powers a major appliance because of the potential for interference. Be certain that the antenna on the unit is fully extended when needed. In the unlikely event that you consistently hear other voices or distracting transmissions on your phone, you may be receiving radio signals from another cordless

telephone or other source of interference. If you cannot eliminate this type of interference, you need to change to a different channel. Finally, it should be noted that some cordless telephones operate at frequencies that may cause interference to nearby TVs and VCRs. To minimize or prevent such interference, the base of the cordless telephone should not be placed near or on top of a TV or VCR. If interference is experienced, moving the cordless telephone farther away from the TV or VCR will often reduce or eliminate the interference.

Cordless Telephone Privacy

Cordless telephones are radio devices. Communications between the handset and base of your cordless telephone are accomplished by means of radio waves which are broadcast over the open airways. Because of the inherent physical properties of radio waves, your communications can be received by radio receiving devices other than your own cordless telephone unit. Consequently, any communications using your cordless telephone may not be private.

I.C. Notice

Terminal Equipment

NOTICE: This equipment meets the applicable Industry Canada Terminal Equipment Technical Specifications. This is confirmed by the registration number. The abbreviation, IC, before the registration number signifies that registration was performed based on a Declaration of Conformity indicating that Industry Canada technical specifications were met. It does not imply that Industry Canada approved the equipment.

NOTICE: The Ringer Equivalence Number (REN) for this terminal equipment is marked on the equipment itself. The REN assigned to each terminal equipment provides an indication of the maximum number of terminals allowed to be connected to a telephone interface. The termination on an interface may consist of any combination of devices subject only to the requirement that the sum of the Ringer Equivalence Numbers of all the devices does not exceed five.

Radio Equipment

The term "IC:" before the radio certification number only signifies that Industry Canada technical specifications were met. Operation is subject to the following two conditions: (1) this device may not cause interference, and (2) this device must accept any interference, including interference that may cause undesired operation of the device. "Privacy of communications may not be ensured when using this telephone".

One Year Limited Warranty

Important: Evidence of original purchase is required for warranty service. WARRANTOR: UNIDEN AMERICA CORPORATION ("Uniden")
ELEMENTS OF WARRANTY: Uniden warrants, for one year, to the original retail owner, this Uniden Product to be free from defects in materials and craftsmanship with only the limitations or exclusions set out below.

WARRANTY DURATION: This warranty to the original user shall terminate and be of no further effect 12 months after the date of original retail sale. The warranty is invalid if the Product is (A) damaged or not maintained as reasonable or necessary, (B) modified, altered, or used as part of any conversion kits, subassemblies, or any configurations not sold by Uniden, (C) improperly installed, (D) serviced or repaired by someone other than an authorized Uniden service center for a defect or malfunction covered by this warranty, (E) used in any conjunction with equipment or parts or as part of any system not manufactured by Uniden, or (F) installed or programmed by

anyone other than as detailed by the owner's manual for this product.

STATEMENT OF REMEDY: In the event that the product does not conform to this warranty at any time while this warranty is in effect, warrantor will either, at its option, repair or replace the defective unit and return it to you without charge for parts, service, or any other cost (except shipping and handling) incurred by warrantor or its representatives in connection with the performance of this warranty. Warrantor, at its option, may replace the unit with a new or refurbished unit. THE LIMITED WARRANTY SET FORTH ABOVE IS THE SOLE AND ENTIRE WARRANTY PERTAINING TO THE PRODUCT AND IS IN LIEU OF AND EXCLUDES ALL OTHER WARRANTIES OF ANY NATURE WHATSOEVER, WHETHER EXPRESS, IMPLIED OR ARISING BY OPERATION OF LAW, INCLUDING, BUT NOT LIMITED TO ANY IMPLIED WARRANTIES OF MERCHANTABILITY OR FITNESS FOR A PARTICULAR PURPOSE.

THIS WARRANTY DOES NOT COVER OR PROVIDE FOR THE REIMBURSEMENT OR PAYMENT OF INCIDENTAL OR CONSEQUENTIAL DAMAGES. Some states do not allow this exclusion or limitation of incidental or consequential damages so the above limitation or exclusion may not apply to you.

LEGAL REMEDIES: This warranty gives you specific legal rights, and you may also have other rights which vary from state to state. This warranty is void outside the United States of America and Canada.

PROCEDURE FOR OBTAINING PERFORMANCE OF WARRANTY: If, after following the instructions in the owner's manual you are certain that the Product is defective, pack the Product carefully (preferably in its original packaging). Disconnect the battery from the Product and separately secure the battery in its own separate packaging within the shipping carton. The Product should include all parts and accessories originally packaged with the Product. Include evidence of original purchase and a note describing the defect that has caused you to

return it. The Product should be shipped freight prepaid, by traceable means, to warrantor at:
Uniden America Service
4700 Amon Carter Blvd.
Fort Worth, TX 76155



As an Energy Star[®] Partner, Uniden has determined that this product or product models meets the Energy Star[®] guidelines for energy efficiency. Energy Star[®] is a U.S. registered mark.

Index

| | |
|---|--------|
| A | |
| AC adapter information | 54 |
| Answering machine | |
| Remote operation | 52 |
| Reviewing messages | 51 |
| Setup | 45 |
| Turning on & off | 50 |
| Audio boost | 35 |
| B | |
| Battery pack | |
| Information | 54 |
| Installing | 56 |
| Replacement and handling | 55 |
| Beltclip installation | 18 |
| C | |
| Caller ID service | 41 |
| Call waiting | 32 |
| Deleting | 43 |
| Making a call | 32 |
| Viewing | 42 |
| Channel | 36 |
| Charging a battery back | 17 |
| CID announce | 14, 42 |
| Cleaning contacts | 57 |
| Clock | 19 |
| Connect the base unit | 12 |
| Connect the cradle | 17 |
| D, E, F, G, H | |
| Dial mode | 13 |
| Earpiece volume | 35 |
| Emergency dial | 23, 31 |
| Finding the lost handset | 36 |
| Greeting | 48, 49 |
| Headset installation | 18 |
| I, J, K, L | |
| I.C. Notice | 67 |
| Installing the phone | 11 |
| Intercom | 38 |
| Interference | 66 |
| Liquid damage | 61 |
| M, N, O, P, Q | |
| Maintenance | 54 |
| Making a call | 30 |
| Message alert | 47 |
| One-touch speed dial (Base) | 24 |
| Personal identification number (PIN) | 49 |
| Power failure | 29, 54 |
| Precautions | 62 |
| Product overview | 5 |
| R | |
| Receiving a call | 30 |
| Record time | 46 |
| Redial | 33 |
| Remote operation | 52 |
| Reviewing messages | 51 |

| | |
|--|--------|
| Ring time | 47 |
| Ringer tone and volume | 34 |
| S | |
| Screening calls | 46, 52 |
| Setting Caller ID on Call Waiting (CIDCW) | 21 |
| Setup | |
| Answering machine | 45 |
| Base | 19 |
| Handset | 21 |
| Speaker volume | 35 |
| Specifications | 54 |
| Speed dial memory | |
| Making calls | 31 |
| One-touch speed dial (Base) | 24 |
| Storing names and numbers | 25 |
| T, U | |
| Technical information | 54 |
| Tone dialing switch over | 40 |
| Transferring a call | 39 |
| Traveling out of range | 58 |
| Troubleshooting | 58 |
| V, W, X, Y, Z | |
| Visual ringer | 14 |
| Wall mounting | 15 |
| Warranty | 68 |

Memo

Remote Operation Card

C U T

REMOTE OPERATION CARD

Uniden®

Remote access away from home Turn on the answering system remotely

1. Call your phone number from a touch-tone phone.
 2. During the outgoing message, press **[0]** and enter your PIN code. The answering system announces the number of messages stored in memory and the voice prompts. The phone stands by for you to enter a command.
 3. To quit, hang up the phone.
1. Call your phone and let it ring 10 times until it answers.
 2. Press **[0]** and enter your PIN code.
 3. Press **[0]** then **[5]** to stop the announcement.
 4. Press **[0]** then **[6]** to turn the answering system on.

C U T

REMOTE OPERATION CARD

Uniden®

Remote access away from home Turn on the answering system remotely

1. Call your phone number from a touch-tone phone.
 2. During the outgoing message, press **[0]** and enter your PIN code. The answering system announces the number of messages stored in memory and the voice prompts. The phone stands by for you to enter a command.
 3. To quit, hang up the phone.
1. Call your phone and let it ring 10 times until it answers.
 2. Press **[0]** and enter your PIN code.
 3. Press **[0]** then **[5]** to stop the announcement.
 4. Press **[0]** then **[6]** to turn the answering system on.

C U T

MEMORY LOCATION MEMO

| Memory Location | Name | Phone Number |
|-----------------|------|--------------|
| 1 | | |
| 2 | | |
| 3 | | |
| 4 | | |
| 5 | | |

C U T

MEMORY LOCATION MEMO

| Memory Location | Name | Phone Number |
|-----------------|------|--------------|
| 1 | | |
| 2 | | |
| 3 | | |
| 4 | | |
| 5 | | |

Remote Operation Card

C U T

MEMORY LOCATION MEMO

| Memory Location | Name | Phone Number |
|-----------------|------|--------------|
| 6 | | |
| 7 | | |
| 8 | | |
| 9 | | |
| 10 | | |

C U T

MEMORY LOCATION MEMO

| Memory Location | Name | Phone Number |
|-----------------|------|--------------|
| 6 | | |
| 7 | | |
| 8 | | |
| 9 | | |
| 10 | | |

C U T

| Task | Key |
|------------------------------|-----|
| Repeat a Message | 0 1 |
| Play Incoming Messages | 0 2 |
| Skip a Message | 0 3 |
| Delete a Message | 0 4 |
| Stop Operation | 0 5 |
| Answering System On | 0 6 |
| Memo Record/Stop | 0 7 |
| Greeting Message Record/Stop | 0 8 |
| Answering System Off | 0 9 |
| Voice Prompts | 1 0 |

C U T

| Task | Key |
|------------------------------|-----|
| Repeat a Message | 0 1 |
| Play Incoming Messages | 0 2 |
| Skip a Message | 0 3 |
| Delete a Message | 0 4 |
| Stop Operation | 0 5 |
| Answering System On | 0 6 |
| Memo Record/Stop | 0 7 |
| Greeting Message Record/Stop | 0 8 |
| Answering System Off | 0 9 |
| Voice Prompts | 1 0 |

At Uniden, we'll take care of you!

Thank you for purchasing a Uniden product. If you have any questions or problems, **please do not return this product to the place of purchase.**

| | |
|--|---|
| Having trouble? | Our customer care specialists are here to help you! Visit our web-site at www.uniden.com or call our Customer Service Hotline at 1-800-297-1023 during regular business hours.* |
| Need a part? | To order headsets, accessory handsets, replacement batteries, or other accessories, visit our website at www.uniden.com or call 1-800-554-3988 during regular business hours.* |
| Help for our customers with special needs | If you need special assistance due to a disability or have questions on the accessibility features of this product, please call 1-800-874-9314 (voice or TTY) . |

* Central Standard Time. Detailed customer service hours are available at www.uniden.com.

Uniden®

May be covered under one or more of the following U.S. patents:

4,797,916 5,426,690 5,491,745 5,493,605 5,533,010 5,574,727 5,581,598 5,650,790 5,660,269 5,663,981 5,671,248
5,717,312 5,732,355 5,754,407 5,758,289 5,768,345 5,787,356 5,794,152 5,801,466 5,825,161 5,864,619 5,893,034
5,912,968 5,915,227 5,929,598 5,930,720 5,960,358 5,987,330 6,044,281 6,070,082 6,076,052 6,125,277 6,253,088
6,314,278 6,321,068 6,418,209 6,618,015 6,671,315 6,714,630 6,782,098 6,788,920 6,788,953 6,839,550 6,889,184
6,901,271 6,907,094 6,914,940 6,940,867 6,953,118 7,023,176 7,030,819 7,146,160 7,203,307 7,206,403

Other patents pending.

FOR
ACCESSORIES,
GO ONLINE @
WWW.UNIDEN.COM

REGISTER ONLINE TODAY!

THANK YOU FOR BUYING A UNIDEN PRODUCT.

A World Without Wires | **Uniden**[®]

Free Manuals Download Website

<http://myh66.com>

<http://usermanuals.us>

<http://www.somanuals.com>

<http://www.4manuals.cc>

<http://www.manual-lib.com>

<http://www.404manual.com>

<http://www.luxmanual.com>

<http://aubethermostatmanual.com>

Golf course search by state

<http://golfingnear.com>

Email search by domain

<http://emailbydomain.com>

Auto manuals search

<http://auto.somanuals.com>

TV manuals search

<http://tv.somanuals.com>