

**Uniden®**

**DCT 746M**

**SERIES**

**OWNER'S**

**MANUAL**

**OWNER'S MANUAL**

# Contents

<b>WELCOME/FEATURES</b>	<b>2</b>	<b>CALLER ID</b>	<b>45</b>
<b>TERMINOLOGY</b>	<b>3</b>	Caller ID and CIDCW (Caller ID on Call Waiting)	45
<b>CONTROLS &amp; FUNCTIONS</b>	<b>4</b>	<b>MULTI-HANSET FEATURES</b>	<b>50</b>
<b>DISPLAY AND ICONS</b>	<b>6</b>	Multi-Handset Features	50
<b>GETTING STARTED</b>	<b>7</b>	Using DirectLink Mode	50
Setting up the Phone	7	Intercom	52
Expanding Your Phone	12	Room/Baby Monitor	54
Register the Handset	14	<b>ADDITIONAL INFORMATION</b>	<b>55</b>
Changing the Digital Security Code	15	Note on Power Sources	55
Installing the Beltclip	15	General Information	57
Headset Installation	15	<b>TROUBLESHOOTING</b>	<b>58</b>
Main Menu Options	16	Troubleshooting	58
Setting Menu Options	17	Liquid Damage	60
<b>BASICS</b>	<b>26</b>	<b>PRECAUTIONS &amp; WARRANTY</b>	<b>61</b>
Using Your Phone	26	<b>I.C. NOTICE</b>	<b>63</b>
Call Waiting	28	<b>INDEX</b>	<b>64</b>
Placing a Call on Hold	28	<b>MEMORY LIST</b>	<b>65</b>
Redialing a Call	29		
Adjusting the Ringer, Earpiece and Speaker Volume	30		
Mute Microphone	31		
Tone Dialing Switch-over	32		
Traveling Out of Range	32		
Clarity Booster	33		
Privacy Mode	33		
Conferencing	34		
Using One Touch Voice Mail Access	34		
Find Handset	36		
<b>PHONEBOOK</b>	<b>37</b>		
Setting up the Phonebook	37		
Viewing the Phonebook	41		
Making Calls Using the Phonebook	42		
Speed Dialing	42		
Editing or Erasing a Stored Name, Phone Number, Distinctive Ring and Speed Dial	43		
Copying Phonebook Locations	44		

## Welcome

Congratulations on your purchase of the Uniden Multi-Handset Cordless Telephone System! This unit is different from conventional cordless telephones. When the base unit is connected to AC power and a telephone line, it can support up to four handsets. You can now place a fully-featured cordless handset anywhere in your home or office where AC power is available to connect the handset chargers. Extra handsets also allow you to establish a three-way conference call among two handsets and an outside lines.

**Note: Illustrations in this manual are used for explanation purposes. Some illustrations in this manual may differ from the actual unit.**



As an Energy Star® Partner, Uniden has determined that this product or product models meets the Energy Star® guidelines for energy efficiency.

Energy Star® is a U.S. registered mark.

## Features

- 2.4GHz Frequency Hopping Spread Spectrum
- 4 Multi-Handset Expandability (DCX700 handset sold separately)
- Hands Free Speakerphone
- Caller ID/Call Waiting Deluxe (subscribe through local telephone company)
- 80 Dynamic Memory Locations (Phonebook & Caller ID)
- Trilingual Display Options (English, French and Spanish)
- Intercom or Call Transfer between Handsets
- Distinctive Ring Options
- 34 ring types - (14 animal rings, 10 ring tones and 10 melody rings)
- Hold or Mute Call
- Clarity Boost
- True Banner
- DirectLink™ Mode
- Voice Mail Waiting Indicator at handset
- Room/Baby Monitoring
- Battery Level Indicator
- Clock Display

This series features **AutoTalk™** and **AutoStandby™**. AutoTalk allows you to answer a call by just removing the handset from the cradle so you don't have to waste time pushing buttons. AutoStandby allows you to hang up by simply returning the handset to the cradle.

To protect you against mis-billed calls that might result from your phone being activated by other equipment, this series has **Random Code™** digital security, which automatically selects one of more than 10,000,000 digital security codes for the handset and base.

Digital Spread Spectrum Technology uses a wider frequency band than standard digital transmissions. The result is a more secure conversation with the clarity of digital sound, extended range, and minimal interference from other cordless phones.

**IntegriSound™** Built in sound quality which provides life-like conversations.  
With **DirectLink™** mode, you can use two or more handsets as radio transceivers (walkie-talkies).

Be sure to visit our web site: [www.uniden.com](http://www.uniden.com)

Uniden® is a registered trademark of Uniden America Corporation.



AutoTalk, AutoStandby, DirectLink, IntegriSound and Random Code are trademarks of Uniden America.



Mossy Oak New Breakup Pattern is a registered trademark of HAAS Outdoors, Inc. ©2004, all rights reserved.

This Product contains a small selection from the extensive Sounddogs sound effects and production music libraries. For more information on Sounddogs sound effects and music libraries contact Sounddogs at 1-800-315-3647 or at [www.sounddogs.com](http://www.sounddogs.com)

## Terminology

- **Standby Mode** - The handset maybe sitting or off the cradle, but is NOT in use. **talk/flash** or  has not been pressed. No dial tone is present.
- **Talk Mode** - The handset is not in the cradle, and **talk/flash** or  has been pressed and enabling a dial tone.

# Controls & Functions

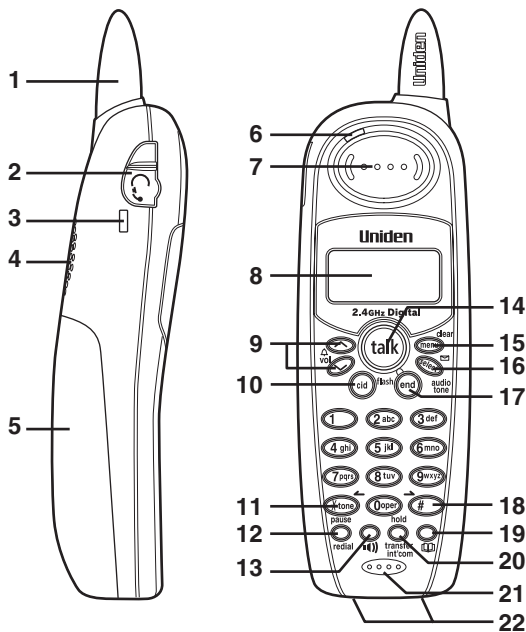

1. Handset Antenna
2. Headset Jack Cover
3. Beltclip Hole
4. Speakerphone Speaker and Ringer
5. Handset Battery Compartment
6. New Message LED
7. Handset Earpiece
8. LCD Display
9.  $\triangle$  (ring)/**vol** (volume) and  $\wedge/\vee$  (P. 30 & 17)  
a. ringer and volume control    b. scroll keys for display screen
10. **cid** (caller ID) (P. 47)
11. **\*/tone/** (P. 32 & 38)
12. **pause/redial** Key (P. 26 & 29)
13.  $\blacksquare$  (speaker) (P. 27)
14. **talk/flash** (P. 26 & 28)
15. **menu/clear** (P. 17 & P. 38)
16. **select/** (voice mail)/**audio tone** (P. 17, 34 & 31)
17. **end** (P. 27)
18. **#/** (P. 38)
19.  $\text{☎}$  (phonebook) (P. 37)
20. **hold/transfer/int'com** (intercom) (P. 28 & 52)
21. Handset Microphone
22. Handset Charging Contacts

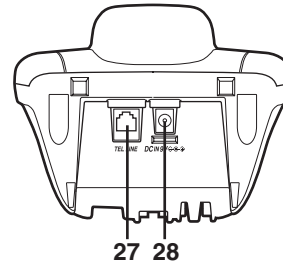
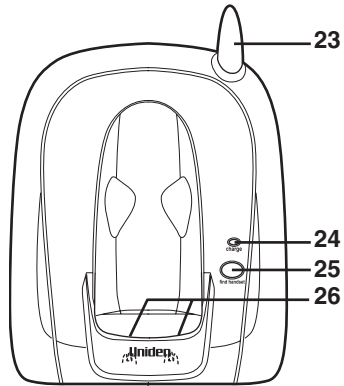

- 23. Base Antenna
- 24. **charge** LED
- 25. *find handset* (P. 36)
- 26. Base Charging Contacts
- 27. **TEL LINE** Jack
- 28. **DC IN 9V** Jack

# Display and Icons

Example of the standby mode display

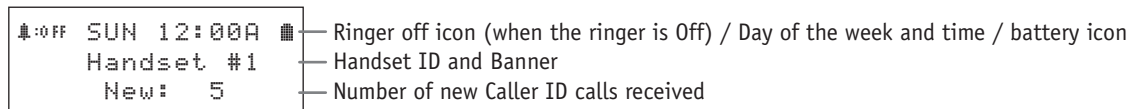

ICON	STATUS	DESCRIPTION
	Standby/Talk	<b>Battery</b> icons indicate the handset battery status. This icon cycles depending on the battery status (full, medium, low, and empty).
	Standby	<b>Ringer off</b> icon indicates that ringer is turned off.
	Talk	<b>Mute</b> icon appears when you mute the handset.
	Talk	<b>Speaker</b> icon appears when the handset speaker phone is used.
	Talk	<b>Booster</b> icon appears when the Clarity Booster feature is in use.
	Talk	<b>Privacy</b> icon appears when the Privacy Mode is turned on.



If your home has specially wired alarm equipment connected to phone line, be sure that installing the system does not disable your alarm equipment.

If you have questions about what will disable alarm equipment, contact your telephone company or a qualified installer.

## Setting up the Phone

Do the following steps:

- A. Choose the best location
- B. Install the rechargeable battery pack into the handset
- C. Connect the base unit and charge the handset
- D. Mount the base unit on a wall

### A. Choose the best location

Before choosing a location for your new phone, read "Installation Considerations" on page 62. Here are some important guidelines you should consider:

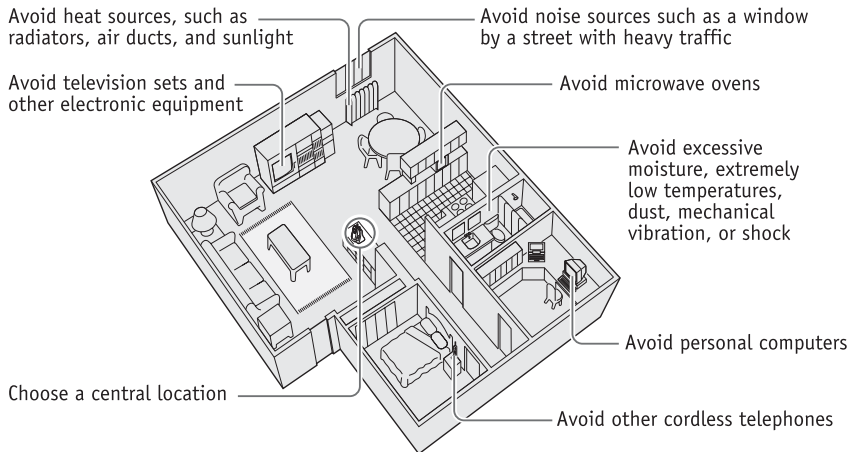



## B. Install the rechargeable battery pack into the handset

The handset is powered by a rechargeable battery pack. The battery recharges automatically when the handset is placed in the base unit.

- 1) Press down on the handset battery case cover (use the finger indentation for a better grip) and slide the cover downward to remove.
- 2) Plug the battery connector (red & black wires) into the jack inside the battery compartment. (The connector notches fit into the grooves of the jack only one way). Match the wire colors to the polarity label in the battery compartment, connect the battery and listen for a click to insure connection.
- 3) Make sure you have a good connection by gently pulling on the battery wires. If the connection is secure, the battery jack will remain in place.
- 4) Place the battery case cover back on the handset and slide it upwards until it clicks into place.

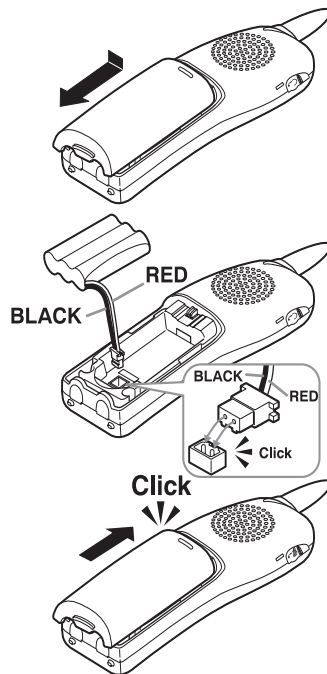

- Use only the Uniden (BT-446) rechargeable battery pack supplied with your cordless telephone.
- Replacement battery packs are also available through the Uniden Parts Department at (800) 554-3988, Monday thru Friday from 8:00 a.m. to 5:00 p.m. or online at [www.uniden.com](http://www.uniden.com)



•Use only the supplied AD-800 AC adapter. Do not use any other AC adapter.

•Do not place the power cord where it creates a trip hazard or where it could become chafed and create a fire or electrical hazard.

## C. Connect the base unit and charge the handset

- 1) Connect the AC adapter to the **DC IN 9V** jack and to a standard 120V AC wall outlet.

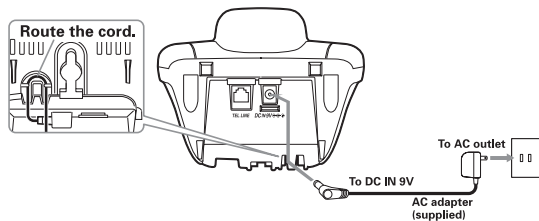

Note:

- Connect the AC adapter to a continuous power supply (i.e., an outlet that is not controlled by a switch).
- Place the base unit close to the AC outlet to avoid long extension cords.

- 2) Place the handset in the base unit with the keypad facing forward.

- 3) Make sure that the **charge** LED illuminates. If the LED does not illuminate, check to see that the AC adapter is plugged in and the handset makes good contact with the base charging contacts.



- 4) Charge your handset at least **15-20 hours before plugging into the phone line.**

- 5) Once the handset battery pack is fully charged, connect the telephone line cords to the **TEL LINE** jack and to a telephone outlets.



If your telephone outlet isn't modular, contact your telephone company for assistance.

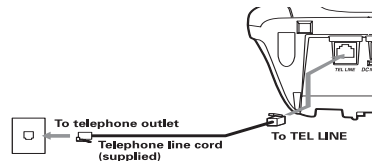

## D. Mount the Base Unit on a Wall

### Standard wall plate mounting

This phone can be mounted on any standard wall plate.

- 1) Plug the AC adapter into the **DC IN 9V** jack. Wrap the AC adapter cord inside the molded wiring channel as shown.
- 2) Plug the AC adapter into a standard 120V AC wall outlet.
- 3) Plug the telephone line cords into the **TEL LINE** jack.
- 4) Plug the telephone line cords into the telephone outlets.
- 5) Align the mounting slots on the base with the mounting posts on the wall. Then push in and down until the phone is firmly seated.

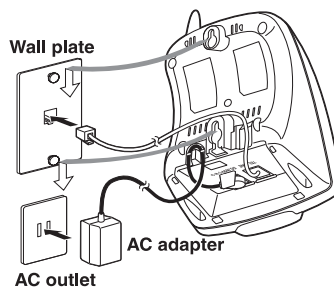

## Direct wall mounting

If you don't have a standard wall plate, you can mount your phone directly to the wall. Before doing this, consider the following:

- Avoid electrical cables, pipes, or other items behind the mounting location that could cause a hazard when inserting screws into the wall.
- Try to mount your phone within 5 feet of a working phone jack to avoid excessive lengths.
- Make sure the wall material is capable of supporting the weight of the base and handset.
- Use #10 screws (minimum length of 1 & 3/8 inches) with anchoring devices suitable for the wall material where the base unit will be placed.

- 1) Insert two mounting screws into the wall (with their appropriate anchoring device), 3 & 15/16 inches apart. Allow about 1/8 of an inch between the wall and screw heads for mounting the phone.
- 2) Refer to steps 1 through 5 on page 10 to mount the telephone.

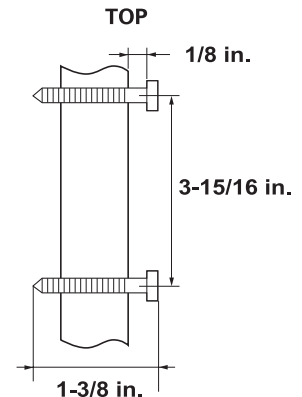

# Expanding Your Phone

## Four Handset Expandability

Your phone supports up to four handsets, including any handsets supplied with your phone. You can now place a fully-featured cordless handset anywhere AC power is available to connect the handset charger. Handsets can be used in DirectLink Mode or on an intercom call without interfering with incoming calls. It is possible to have a three-way conference among two handsets and an outside lines. All of the handsets ring when a call is received.

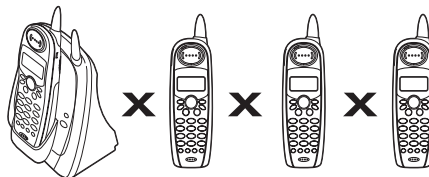

## Backward / Forward Compatibility

Your phone may be compatible with other Uniden 2.4 GHz Digital Expandable Systems. Please visit our website @ [www.uniden.com](http://www.uniden.com) <<http://www.uniden.com>>. Please go to section "Register the Handset" in this owner's manual to register additional handsets to your base.



### IMPORTANT

If you purchase a DCX700 expansion handset, please register the handset to the original/main base before use. The DCX700 will not operate until it is registered.

If you change a global setting in one handset, you change that particular setting for all registered handsets. All other settings (not included under Global Setup) must be set separately through each handset.

## Connect the expansion handset's charger

The handset is powered by a rechargeable battery pack. The battery recharges automatically when the handset is placed in the charger.

- 1) Connect the AC adapter to the DC IN 9V jack and to a standard 120V AC wall outlet.
- 2) Set the charger on a desk or tabletop, and place the handset in the charger with the keypad facing forward.
- 3) Make sure that the **charge** LED illuminates. If the LED does not illuminate, check to see that the AC adapter is plugged in and the handset makes good contact with the base charging contacts.
- 4) Charge the handset battery pack for at least 15-20 hours before using your new cordless telephone for the first time.

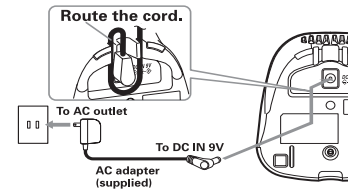

# Register the Handset

If you purchase an extra handset, you need to register the handset before use. Only one handset can be registered at a time.

Handsets supplied with the phone are registered to the base by the factory. When charged, pre-registered handsets display a handset ID number. Handsets that have not been registered display Models vary! Charge handset on the base for registration or refer to Owner's Manual. When you register an extra handset to the base, the handset ID will be assigned.

- 1) Before registering the extra handset, the battery pack **MUST** be charged for 15-20 hours.
- 2) Place the extra handset in the main base unit to begin registration.
- 3) While the handset is registering, Handset Registering will appear in the LCD. When Registration Complete is displayed, the handset has been registered to the base. If Registration Failed appears, please try these steps again.

**For the DCX640 expansion handset (DCT7 series-compatible model)**

- 1) **Disconnect the AC adapter.**
- 2) **While holding "find handset", connect the AC adapter.**  
Keep pressing "find handset" until the **CHARGE** LED starts to blink.
- 3) **On the handset, press and hold # until you hear beep.**

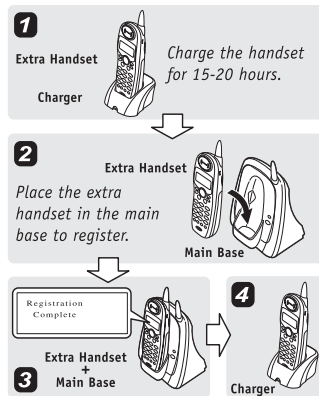

## Changing the Digital Security Code

The digital security code is an identification code used to connect the handset and the base unit. Normally, setting the code is not necessary. In the rare situation that you suspect another cordless telephone is using the same security code, you can change the code. To change the digital security code:

1. Perform the "System Reset" options ("De-register the Handset" and "Replacing the Base Setting") for all the handsets you have (see page 25).
2. Re-register each handset by following the steps on page 14.

## Installing the Beltclip

### To attach the beltclip

Insert the beltclip into the holes on each side of the handset. Press down until it clicks.

### To remove the beltclip

Pull either side of the beltclip to release the tabs from the holes.

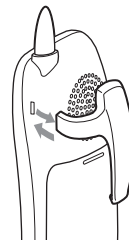

## Headset Installation

Your phone may be used with an optional headset. To use this feature, insert the headset plug into the headset jack. Your phone is ready for hands-free conversations. (Headset may be purchased by calling the Uniden Parts Department or visiting the web site. See page 57.)

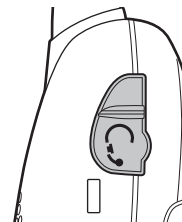



# Main Menu Options

Your phone has four main menu options: **DirectLink Mode**, **Room/Baby Monitor**, **Handset Setup** and **Global Setup** as well as submenu options.

## Default Settings

The default settings set from the factory match the features that most people use. You may not need to change them. However, there are a number of options you must set and entries you must make in memory to take full advantage of all the phone features. The table below lists the default settings.

Function	Handset	Function	Handset
Edit Voice Mail	None	Language (LCD)	English
Ringer Tones	Turkey	Key touch tone	On
Distinctive Ring	On	Day & time	SUN 12:00 AM
Auto Talk	Off	CIDCW	CIDCW on/CWDX off
Anykey Answer	Off	Area Code	None
Banner	" "	Dial Mode	Tone
		Voice Mail Tone	On



For Global Setup and System Reset, when setting options from the handset, make sure the line is not in use and the handsets are within range of the base.

# Setting Menu Options

## Using the interface

Below are some tips for using the software interface on your phone.

- Press **menu/clear** to access the main menu.
- Use **▲/vol/▲** or **▲/vol/▼** to scroll through options.
- Press **select/☒/audio tone** to make a selection.
- Press **menu/clear** to cancel setting and exit the menu.
- If you do not press a key within 30 seconds, the phone will time out and exit the menu mode. When setting Day and Time, the time-out period is extended to two minutes.

```
DirectLink Mode
▶Room Monitor
Handset Setup
```

## Handset Setup

The following submenu options must be set separately for each handset.

### Selecting a Ringer Tone

Ringer tone lets you choose from 14 animal sounds, 10 melodies, or 10 ringer tones:

You must set a separate ringer tone on each handset.

- Animal Sounds: Turkey, Bear, Boar, Crickets, Deer, Dove, Elephant, Elk, Goose, Hawk, Owl, Quail, Tiger, Wolf
- Melodies (Beethoven's Symphony #9 [Beethoven9], For Elise [Elise], We Wish You A Merry Christmas [Merry- Xmas], Home Sweet Home [Hm Swt Hm], Lorri Song #6 [Lorri Song], When the Irish Eyes Are Smiling [Irish Eyes], Aura Lee, Let Me Call You Sweet Heart [Sweetheart], Star Spangled Banner [Star Spngl], Old MacDonald [Old MacDld])
- Ringers (Flicker, Clatter, Soft Alert, Wake Up, Light Bug, Beep Boop, Tone Board, Chip Chop, Party Clap, Reminder)

- 1) Press **menu/clear**. Select the Handset Setup menu, and then the Ringer Tones submenu.
- 2) Press **▲/vol/▲** or **▲/vol/▼** to move the pointer. You will hear the ringer or melody as you scroll through the options.
- 3) Press **select/☒/audio tone**. You will hear a confirmation tone.

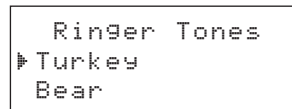

## Distinctive Ringer Setup

Distinctive Ringer allows you to assign a designated ring tone to a stored phonebook number. When a call is received and the Caller ID information matches the information in one of the phonebook memory entries, the phone uses the distinctive ring assigned to that particular caller. You can assign distinctive rings to multiple phonebook memory entries. Switching the setting to Distinctive Off disables distinctive ringing: all incoming calls will have a normal ring tone. Switching to Distinctive On activates all programmed distinctive rings.

- 1) Press **menu/clear**. Select the Handset Setup menu, and then the Distinctive Ring submenu.
- 2) Press **△/vol/∧** or **△/vol/∨** to select On or Off.
- 3) Press **select/☒/audio tone**. You will hear a confirmation tone.

```
Distinctive Ring
▶ On
  Off
```

## Setting AutoTalk

AutoTalk allows you to answer the phone simply by removing the handset from the cradle. You do not have to press any buttons to answer the call.

- 1) Press **menu/clear**. Select the Handset Setup menu, and then the AutoTalk submenu.
- 2) Press **△/vol/∧** or **△/vol/∨** to select On or Off.
- 3) Press **select/☒/audio tone**. You will hear a confirmation tone.

```
Auto Talk
  On
▶ Off
```

## Setting Anykey Answer

Anykey Answer allows you to answer the phone by pressing any number key,

**\*/tone/←** or **\*/→** on the handset.

- 1) Press **menu/clear**. Select the Handset Setup menu, and then the Anykey Answer submenu.
- 2) Press **△/vol/∧** or **△/vol/∨** to select On or Off.
- 3) Press **select/☒/audio tone**. You will hear a confirmation tone.

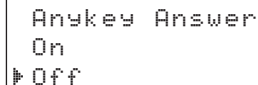

```
Anykey Answer
On
▶ Off
```

## Setting the True Banner

True Banner lets you customize the name your handset displays. The name will be displayed on the LCD screen during Standby Mode, Intercom, Intercom Hold, Room Monitor, and Copy Phonebook operation. The banner name will be displayed on the receiving handset as well.

- 1) Press **menu/clear**. Select the Handset Setup menu, and then the Banner submenu.
- 2) Use the number keypad (**0-9**), **\*/tone/←**, **\*/→**, or **menu/clear** to enter or edit the name.
- 3) Press **select/☒/audio tone**. You will hear a confirmation tone.



```
Banner
Mon's Phone
▲
▶
▼
```

## Selecting a Language

You can change the language the menu display will use. Choose from English, French, or Spanish.

- 1) Press **menu/clear**. Select the Handset Setup menu, and then the Language submenu.
- 2) Press **▲/vol/▲** or **▲/vol/▼** to choose "English," "Français" (French), or "Español" (Spanish).
- 3) Press **select/☒/audio tone**. You will hear a confirmation tone.

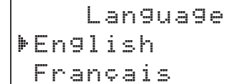

```
Language
▶English
Français
```

## Setting the Key Touch Tone

Key Touch Tone is the tone your keypad makes when keys are pressed. You can turn this tone on or off.

- 1) Press **menu/clear**. Select the Handset Setup menu, and then the Key Touch Tone submenu.
- 2) Press **▲/vol/▲** or **▲/vol/▼** to select On or Off.
- 3) Press **select/☒/audio tone**. You will hear a confirmation tone.

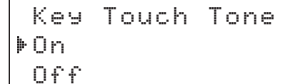

```
Key Touch Tone
▶On
Off
```

## Global Setup

If you change one of the global settings, you change that setting for all registered handsets. Only one handset can change global settings at a time.

### Setting Day and Time

Day & Time sets the day and time of your display.

- 1) Press **menu/clear**. Select the Global Setup menu, and then the Day & Time submenu option.
- 2) Press **▲/vol/▲** or **▲/vol/▼** to select the day of the week, and then **select/☒/audio tone**.
- 3) Press **▲/vol/▲** or **▲/vol/▼** to set hour, and then press **select/☒/audio tone**.
- 4) Press **▲/vol/▲** or **▲/vol/▼** to set minute, and then press **select/☒/audio tone**.
- 5) Press **▲/vol/▲** or **▲/vol/▼** to choose AM or PM, and then press **select/☒/audio tone**. You will hear a confirmation tone.

```
Day & Time
SUN 12:00 AM
[←/↑/↓/→/SELECT]
```



If no key is pressed for two minutes, the phone will exit the menu mode.

## Setting CIDCW (Caller ID on Call Waiting)

CIDCW sets the Caller ID on Call Waiting (CIDCW) displays the name and number of an incoming call while you are on the line. Call Waiting Deluxe (CWDX) allows you to handle call waiting calls in seven different ways. See page 46 for instructions on using call waiting deluxe.

- 1) Press **menu/clear**. Select the Global Setup menu, and then the CIDCW submenu.
- 2) Press  $\Delta$ /**vol**/ $\wedge$  or  $\Delta$ /**vol**/ $\vee$  to select CW On/CWDX On, CW On/CWDX Off, or CW Off/CWDX Off.
- 3) Press **select**/ $\boxtimes$ /**audio tone**. You will hear a confirmation tone.

```
CIDCW
CW On /CWDX On
▶CW On /CWDX Off
```

## Setting the Area Code

If you enter a 3-digit area code number in the "Area Code" option, your local area code does not appear in the Caller ID message. When calls are received from outside your local area code, you will see a full 10-digit number.

- 1) Press **menu/clear**. Select the Global Setup menu, and then the Area Code submenu.
- 2) Use the number keypad (**0-9**) to enter a 3-digit area code. If an area code has already been stored, it will appear in the display. Press **menu/clear** to delete the stored code, then enter a new one.
- 3) Press **select**/ $\boxtimes$ /**audio tone**. You will hear a confirmation tone.

```
Area Code
■---
```



## Setting the Dial Mode

Dial Mode sets the dial mode to tone or pulse. Most phone systems use tone dialing; the default setting is tone dialing. Set the dialing mode to match the dialing system used by your local phone service.

- If you are not sure of your dialing system, make a trial call. If the call connects, leave the setting as is; otherwise set the unit to pulse dialing.
- If your phone system requires pulse dialing and you need to send DTMF tones in certain situations during a call, you may switch over to tone dialing (refer to "Tone Dialing Switch-over" on page 32).

- 1) Press **menu/clear**. Select the Global Setup menu, and then the Dial Mode submenu.
- 2) Press **△/vol/∧** or **△/vol/∨** to select Tone or Pulse (the initial setting is Tone).
- 3) Press **select/☒/audio tone**. You will hear a confirmation tone.

```
Dial Mode
▶ Tone
Pulse
```

## System Reset

### De-register the Handset

- 1) Press and hold **#** and **end** for more than 5 seconds. Select the Deregister HS submenu.
- 2) Press **△/vol/∧** or **△/vol/∨** to select the handset ID to be de-registered from the list, and then press **select/☒/audio tone**. Deregister HS appears.
- 3) Press **select/☒/audio tone**. You will hear a confirmation tone.  
When de-registration is complete, Models vary!  
Charge handset on the base for registration or refer to Owner's Manual.

```
Which Handset?  
▶ Handset #1  
Handset #2
```

```
Deregister HS  
Yes  
▶ No
```

### Replacing the Base Setting

- 1) Press and hold **#** and **end** for more than 5 seconds. Select the Replacing Base submenu. Replace base appears.
- 2) Press **select/☒/audio tone**. You will hear a confirmation tone.  
The base information will be deleted.  
When the base information is deleted, the handset displays Models vary! Charge handset on the base for registration or refer to Owner's Manual.  
Register the handset to the new base (see page 14).

```
Replace base  
Yes  
▶ No
```

# Using Your Phone

## Making and Receiving Calls

### Making a call

#### From the handset

- 1) Remove the handset from the base.
- 2) Press **talk/flash**.
- 3) Listen for the dial tone.
- 4) Dial the number.

OR

- 1) Remove the handset from the base.
- 2) Dial the number.

If pause is required in the dialing sequence, press **pause/redial**. P appears in the display, which represents a 2-second pause.

- 3) Press **talk/flash**.

#### From the Handset Speakerphone

- 1) Remove the handset from the base.
- 2) Press **☎**.
- 3) Listen for the dial tone.
- 4) Dial the number.
- 5) When the other party answers, talk into the microphone.



- To set "Autotalk," see page 19 or to set "Anykey Answer" see page 20.
- If the line(s) is already in use, the base and all registered handsets that are not currently in use will display "Line In Use."
- The handset microphone is located at the bottom of the handset.
- For best performance, use the speaker phone in a quiet room and let the caller finish speaking before you speak. If you or the other party has difficulty hearing, adjust the speaker volume.

## Receiving a call

- 1) Remove the handset from the base. (If AutoTalk is on, the phone will automatically answer the call when you pick it up.)
- 2) Press **talk/flash**.

OR

If the handset is off the base, press **talk/flash**. If Any Key Answer is on, you can also press any number key.

## Hanging Up

From the handset, press **end** or return the handset to the base.

From the handset speakerphone, press **end** or return the handset to the base.

## Switching to the Handset Speakerphone During a Call

To switch a normal call to the speakerphone, press **⏻** on the handset. To switch from a speakerphone call to a normal call, press **⏻**.

## Call Waiting

If you have Call Waiting service and a call waiting tone sounds while you are on a call, press **talk/flash** on the handset to accept the waiting call. There is a short pause, and then you will hear the new caller. To return to the original caller, press **talk/flash** again.

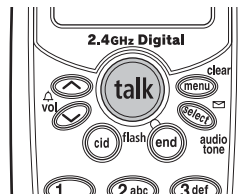

## Placing a Call on Hold

- 1) During a call, press **hold/transfer/int'com** on the handset. The call will be put in hold.
- 2) To talk to the caller, press **talk/flash** or **Ⓜ** on a handset. The phone will return to the call.



- You must subscribe through your local telephone company to receive Call Waiting or Caller ID on call waiting service.
- You can place a call on hold for 5 minutes. When 5 minutes has passed, the call is disconnected, and the phone returns to standby mode.
- While a call is on hold, CIDCW can not be received.



- If the number exceeds 32 digits, only the first 32 digits are retained in redial memory.
- If the redial memory is empty, you will hear a beep.
- To store redial numbers in the Phonebook, see page 40.

## Redialing a Call

The last three phone numbers dialed can be quickly redialed from the handset.

### Redialing from Standby Mode

- 1) With the phone in standby mode, press **pause/redial**.
- 2) Press **pause/redial** or  $\Delta$ /**vol**/ $\wedge$  or  $\Delta$ /**vol**/ $\vee$  to scroll through the last three number dialed.
- 3) Press **talk/flash** or  $\blacksquare$  to dial the number in the display.
- 4) To hang up, press **end**.

### Redialing from Talk Mode

- 1) Press **talk/flash** or  $\blacksquare$ .
- 2) Press **pause/redial**. The last number dialed will be displayed and redialed. To hang up, press **end**.

### Deleting a Redial Record

- 1) With the phone in standby mode, press **pause/redial**.
- 2) Press **pause/redial** repeatedly to display the number to be deleted.
- 3) Press **menu/clear**.
- 4) Press  $\Delta$ /**vol**/ $\wedge$  or  $\Delta$ /**vol**/ $\vee$  to choose **Yes**.
- 5) Press **select**/ $\boxtimes$ /**audio tone** or **menu/clear**. The redialed number is deleted.

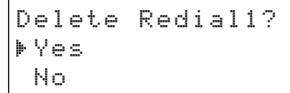
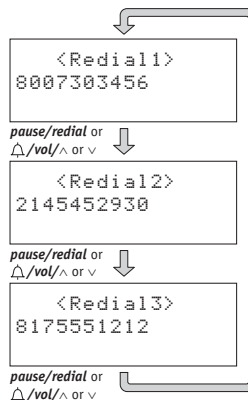

# Adjusting the Ringer, Earpiece and Speaker Volume

## Handset ringer volume

Press the volume up key or volume down key in standby mode to select one of three ringer volume (off, low, or high).

## Earpiece and speaker volume

During a call, press the volume up key or volume down key on the handset to change the earpiece or speaker volume. This setting will remain in effect after the telephone call has ended.

If you press the volume up key when the earpiece is at the maximum volume level, an error tone sounds.

The error tone also sounds if you press the volume down key at the lowest volume.

## Ringer Mute

You can mute the ringer tone temporarily for each handset. When the phone is ringing, press **end** on the handset you want to mute. The mute will last for the current incoming call only. The ringer tone will return to the previous setting starting with the next incoming call.

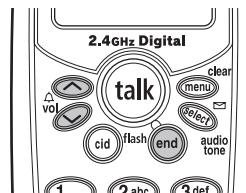

While charging a handset, you can not mute the ringer tone for the handset.



- You can change the audio tone level during a call, intercom, room monitor or DirectLink.
- The Audio Tones feature can not be used while using speaker phone.

## Audio Tones

The audio tone features provide three different tone levels. If you have difficulty hearing a caller, press **select/☒/audio tone**. The default setting, Natural Tone, is recommended for hearing aid users.

## Mute Microphone

You can temporarily mute the microphone so that the caller cannot hear you.

- 1) Press **menu/clear** during talk mode (while the phone is in use) to mute the microphone.
- 2) Press **▲/vol/▲** or **▲/vol/▼** to move the pointer to **Mute** and then **select/☒/audio tone**.

**Mute On** and  appear in the display. To cancel muting, repeat above step again when **Mute** is set to on, **Mute Off** appears.



## Tone Dialing Switch-over

If your telephone company requires pulse dialing, you can switch-over to tone dialing after the call connects. This feature is useful when you need tone dialing to use any automated menu systems, such as telephone bank tellers, telephone prescription refills, customer support menus, etc.

If your phone is set to pulse dialing mode, make your call normally. Once your call connects, press the **\*/tone/←** key. Any digits you enter from then on will be sent as tone digits. When this particular call ends, the phone automatically returns to pulse dialing mode.

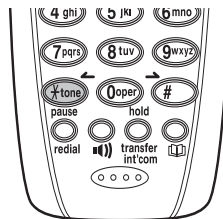

## Traveling Out of Range

During a call, as you begin to move your handset too far from your base unit, noise may increase. If you pass the range limits of the base unit, you will hear a beep and see **Out of Range** on the display, and then the handset returns to standby mode. You may return to the call if you move your handset within the range limits of the base and press **talk/flash** or **ⓘ** within 30 seconds.



## Clarity Booster

If you encounter interference while using your phone, you can manually improve the sound by setting the Clarity Booster to on. **This works only when the phone is in use.**

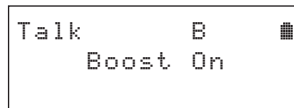

- 1) While on a call, press *menu/clear*.
- 2) Press  $\Delta$ /*vol*/ $\wedge$  or  $\Delta$ /*vol*/ $\vee$  to move the pointer to Clarity Boost, and then *select*/ $\boxtimes$ /*audio tone*.  
Boost On and B appear in the display.  
Use the same procedure to turn off Clarity Booster. Boost Off appears.

## Privacy Mode

Privacy mode prevents interruption from other registered handsets. **This works only when the phone is in use.**

- 1) While on a call, press *menu/clear*.
- 2) Press  $\Delta$ /*vol*/ $\wedge$  or  $\Delta$ /*vol*/ $\vee$  to move the pointer to Privacy Mode, and then *select*/ $\boxtimes$ /*audio tone*.

Privacy Mode On and  appear in the display. To allow other registered handset to join a call, exit privacy mode. Use the same procedure above. Privacy Mode Off appears.

If another handset is in Privacy Mode, you cannot join the call. If someone is using the handset in Privacy Mode, Unavailable appears in the display when you try to join the call.

# Conferencing

If you have more than one handset, up to three people can participate in a conference call. A three-way conference call consists of an outside line and two handsets. You can easily join a call already in progress.

- 1) Press **talk/flash** or **Ⓜ** on the handset to join the call.
- 2) To hang up, return the handset to the cradle or press **end** on the handset. The other handset will still be connected to the call.

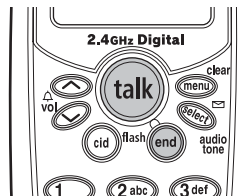

# Using One Touch Voice Mail Access

If you subscribe to voice mail service, you can use your phone to access your voice mailbox. The new message LED flashes whenever you have messages waiting in your voice mailbox. Just program the handset with your access number, and you can get your messages at the touch of a button on the handset. (The voice mail service provider will supply you with the access number. This number may be simply a phone number. Refer to the provider's literature).

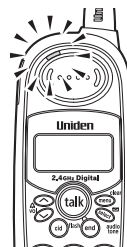

When you have messages, simply pick up the handset and press **select/☒/audio tone**. If you have not entered the access number or it has been deleted, when you press **select/☒/audio tone**, No Number Stored Store number in menu setup appears and you will hear a beep. The phone returns to standby mode.



You must subscribe to voice mail service from your telephone company in order to use this feature. The voice mail service company will provide you with the access number.

## Programming your Voice Mail Access Number

Edit Voice Mail No. allows you to program or delete the voice mail access number.

- 1) Press **menu/clear**. Select the Handset Setup menu, and then the Edit Voice Mail submenu.
- 2) Use the number keypad to enter your personal access number (up to 20 digits). If you have an access number already entered, the current number will appear in the display. To delete that number, press **menu/clear**.
- 3) If you need to have the phone wait before sending the next digits, press **pause/redial**. A P appears in the display each time you press **pause/redial**; each pause inserts a two-second delay in the dialing sequence, and each pause counts as one digit.
- 4) Press **select/☒/audio tone**. You will hear the confirmation tone.

```
Edit V_mail No.  
1234567890■
```

## Voice Mail Tone

- 1) Press **menu/clear**. Select the Global Setup menu, and then the Voice Mail Tone submenu.
- 2) Press **▲/vol/▲** or **▲/vol/▼** to set the voice message indication (SDT message signal) to On or Off.
- 3) Press **select/☒/audio tone**. You will hear a confirmation tone.

```
Voice Mail Tone  
▶ On  
Off
```

## Resetting the New Message LED

If the LED remains on after you've retrieved your messages, you may need to reset the indicators. With the phone is in standby mode, press and hold ***find handset*** on the base until the paging sound stops (about 5 seconds).

## Find Handset

To locate the handset, press ***find handset*** on the base when the phone is in standby mode. All registered handsets beep for 60 seconds, and **Paging** appears on the handset display. To cancel paging, press any key on the handset or ***find handset*** on the base.

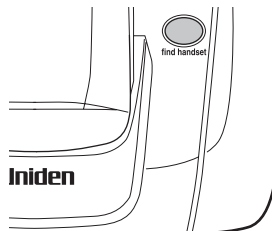

If the battery pack is completely drained, the handset will not beep.

# Setting up the Phonebook

You can store names and numbers in your phone's phonebook, search for names alphabetically, and dial phonebook entries with just a few key presses. Phonebook memory is stored independently in the cordless handsets. You can store up to 80 numbers in each handset.

The phone uses the same memory locations to store phonebook entries and Caller ID messages. Any empty phonebook locations are used to store Caller ID messages. For example, if you have stored 80 phonebook entries on your handset, the base will not store Caller ID messages.

The memory locations in the handset are not limited to phone numbers. You can also store a group of numbers (up to 20 digits) that you need to enter once your call connects. This is referred to as Chain Dialing.

## Storing and Editing Phone Numbers, Names, Distinctive Rings and Speed Dial

- 1) When the phone is in standby mode, press **☰**.
- 2) Press **▲/vol/▲** or **▲/vol/▼** to select **Store newly**.
- 3) Press **select/☒/audio tone**. **Store/Edit Name** appears.

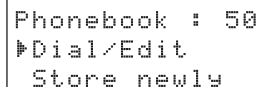

Phonebook : 50  
▶Dial/Edit  
Store newly

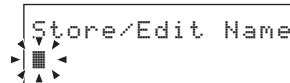

Store/Edit Name

4) Enter the name (up to 16 characters) by using the number keypad. If a name is not required, go to step 5 <No Name> will be used as the name.

Refer to the letters on the number keys to select the desired characters. With each press of a number key (0-9), the displayed character appears in the following order: Upper case letters first, lower case letters next and finally the number corresponding to the key.

	Number of times key is pressed								
keys	1	2	3	4	5	6	7	8	9
1	1								
2 abc	A	B	C	a	b	c	2		
3 def	D	E	F	d	e	f	3		
4 ghi	G	H	I	g	h	i	4		
5 jkl	J	K	L	j	k	l	5		
6 mno	M	N	O	m	n	o	6		
7 pqrs	P	Q	R	S	P	q	r	s	7
8 tuv	T	U	V	t	u	v	8		
9 wxyz	W	X	Y	Z	w	x	y	z	9
0 oper	&	<	>	<	>	/	(blank)	...	...
	*	*	*	?	!	@	'	"	*
	#	0							

For example, to enter Movies:

- 1) Press 6 once, and then press #/ → to move the cursor to the right.
- 2) Press 6 six times.
- 3) Press 8 six times.
- 4) Press 4 six times.
- 5) Press 3 five times.
- 6) Press 7 eight times.

### If you make a mistake while entering a name

Use \*/tone/← or #/→ to move the cursor to the incorrect character.

Press **menu/clear** to erase the wrong character, and then enter the correct character. To delete all characters press and hold **menu/clear**.



- Selecting a phonebook location where a number is already stored overwrites the old number. The new number will be stored in the phonebook location.
- When the memory is full, you will hear a beep and **Memory Full** appears. You cannot store names and numbers.
- The pause key counts as one digit. Pressing **pause/redial** more than once increases the length of the pause between numbers. Each pause represents a 2 second delay.

5) Press **select/☒/audio tone** to store the name; **Store/Edit No.** appears.

```
Store/Edit No.
8007303456■
```

6) Use the number keypad, **\*/tone/←**, or **#/→** to enter the phone number (up to 20 digits).

If you make an error, use **menu/clear** to erase the incorrect digits. When you are finished, press **select/☒/audio tone** to store the number.

7) If you store the phonebook location from the handset, **Distinctive Ring** appears. Press **△/vol/∧** or **△/vol/∨** to move the pointer to one of the Distinctive Ring options and then press **select/☒/audio tone**.

```
Distinctive Ring
▶No Selectn
Turkey
```

If you choose not to store a Distinctive Ring, simply select the "No Selectn" option.

8) **Speed Dial** appears. Press **△/vol/∧** or **△/vol/∨** to move the pointer to select the Speed dial location (10 locations: SPD1-SPD0).

```
Speed Dial
▶No Selectn
SPD1:<Empty>
```

If you choose not to store the name/number as a Speed Dial, simply choose the "No Selectn" option.

9) Press **select/☒/audio tone**. You will hear a confirmation tone, and **Done!** appears in the display.

```
Movies
800-730-3456
▶Beethoven9/SPD1
```



## Storing Caller ID Messages in the Phonebook

Messages shown in the Caller ID list (see page 47) can be stored in the phonebook. The phone number and name of the party on the Caller ID list can be stored in memory.

- 1) When the phone is in standby mode, select the Caller ID message to be stored.
- 2) Press **select/☒/audio tone**. *Store/Edit Name* appears.  
If the Caller ID message is already stored in memory, you will hear a beep and *This data is already stored!!* appears. The number will not be stored.
- 3) To complete the setting, follow the steps 4-9 in "Storing and Editing Phone Numbers, Names, Distinctive Rings and Speed Dial" on page 37.



## Storing a Redial Record

- 1) With the phone in standby mode, press **pause/redial**.
- 2) Press **pause/redial** repeatedly to display the number to be stored.
- 3) Press **select/☒/audio tone**. *Store/Edit Name* appears.
- 4) To complete the setting, follow the steps 4-9 in "Storing and Editing Phone Numbers, Names, Distinctive Rings and Speed Dial" on page 37.



- If a call comes in via a telephone system that does not offer Caller ID service, no information is stored.
- If the Caller ID message was received as a private/unknown number, or the message does not have the number, you cannot store the message in the phonebook. If it was received as private/unknown name, the message will be stored as <No Name>.
- Even if all 80 memory locations are full, the message will be stored in the phonebook. However, the message will be erased from the Caller ID list.

## Viewing the Phonebook

- 1) Press .
- 2) Press  $\Delta$ /**vol**/ $\wedge$  or  $\Delta$ /**vol**/ $\vee$  to select **Dial/Edit**, and then press **select**/**/audio tone**.
- 3) Press  $\Delta$ /**vol**/ $\wedge$  or  $\Delta$ /**vol**/ $\vee$  to scroll through the phonebook locations. Phonebook locations appear in alphabetical order (from first to last when you press  $\Delta$ /**vol**/ $\vee$ , from last to first when you press  $\Delta$ /**vol**/ $\wedge$ ).

You can also use the letters on the number keys to select the first letter of the desired name. Press a number key (**2-9** and **0**) once for the first letter, twice for the second letter, and so on. The first location that begins with the letter you entered appears.

For example, to search for an entry beginning with the letter M, press **6** once. Press  $\Delta$ /**vol**/ $\wedge$  or  $\Delta$ /**vol**/ $\vee$ , until the phonebook location is displayed.

- 4) To finish the viewing operation, press **end** (or  during a call).

# Making Calls Using the Phonebook

- 1) When the phone is in standby mode, view the phonebook location to dial (see "Viewing the Phonebook" on page 41).
- 2) Press **talk/flash** or **Ⓜ**.
- 3) To hang up press **end**.

```
Movies
800-730-3456
↓Beethoven9/SPD1
```

## From Talk Mode



- 1) Press **talk/flash** or **Ⓜ**.
- 2) View the phonebook location to dial (see "Viewing the Phonebook" on page 41).
- 3) Press **select/☒/audio tone**. The number in the displayed phonebook location is dialed.
- 4) To hang up press **end**.

# Speed Dialing

You can program up to ten speed dial numbers in each handset. You must program a speed dial number before you can use the speed dialing feature. When the phone is in standby mode, press and hold a number key (**0-9**) associated with the speed dial until the phone number appears, and then press **talk/flash** or **Ⓜ** on the handset. The number stored in the speed dial (SPD1 - SPD0) is dialed.

## Editing or Erasing a Stored Name, Phone Number, Distinctive Ring and Speed Dial

1) When the phone is in standby mode, press .

To delete all phonebook locations, press  $\Delta$ /**vol**/ $\wedge$  or  $\Delta$ /**vol**/ $\vee$  to select **Delete All**, and press **select**/**/audio tone**. **Delete All?** appears. Use  $\Delta$ /**vol**/ $\wedge$  or  $\Delta$ /**vol**/ $\vee$  to select **Yes**, and then press **select**/**/audio tone**. You will hear a confirmation tone.

Phonebook : 50
Copy
▶Delete All

2) Press  $\Delta$ /**vol**/ $\wedge$  or  $\Delta$ /**vol**/ $\vee$  to select **Dial/Edit**, and then press **select**/**/audio tone**.

3) Use  $\Delta$ /**vol**/ $\wedge$  or  $\Delta$ /**vol**/ $\vee$  or the number keypad to select desired phonebook entry (see "Viewing the Phonebook" on page 41).

4) When you have found the desired phonebook entry, Press **select**/**/audio tone** to edit the entry. To delete the entry, press **menu/clear**.

5) If you are deleting the entry, you will hear a confirmation tone, and **Deleted!** appears in the display.

If you are editing the entry, follow the steps 4 to 9 under "Phonebook (Storing Phone Numbers, Names, Distinctive Rings, and Speed Dial)" on page 37 to complete the editing operation.

# Copying Phonebook Locations

If you have more than one handsets, copy Phonebook allows you to transfer stored phonebook locations from handset to the other handset without having to manually re-enter names and numbers. You can transfer one memory (phonebook location) at a time, or all memory locations at once.

- 1) When the phone is in standby mode, press **☰**.
- 2) Press **△/vol/∧** or **△/vol/∨** to select **Copy**, and then press **select/☒/audio tone**.
- 3) Press **△/vol/∧** or **△/vol/∨** to select the handset to which you want transfer the phonebook locations and then press **select/☒/audio tone**.
- 4) Press **△/vol/∧** or **△/vol/∨** to select **One Memory** or **All Memory**, and then press **select/☒/audio tone**.

```
Copy Phonebook
▶ One Memory
All Memory :xxx
```

If you select **All Memory**, **Are you sure?** appears on the display screen. Press **△/vol/∧** or **△/vol/∨** to select **Yes**, and then press the **select/☒/audio tone**.

If you select **One Memory**, press **△/vol/∧** or **△/vol/∨**, or the number key (**2-9 and 0**) to select the phonebook location you want to export and then press **select/☒/audio tone**.

- 5) The phonebook locations will be transferred to the handset. Copying and the receiving handset name appear. When the transfer is completed, **Done!** appears on the handset.



- Even if all 80 memory locations are full, the message will be stored in the phonebook. However, the oldest Caller ID message will be erased from the Caller ID list.
- If you stored 80 Phonebook locations, you can not store the phonebook locations and you will hear the beep.
- If the selected handset is party is in out of range or data transfer is canceled, **Unavailable** appears in the display. Phonebook locations will not be transferred.



- If you answer a call before the Caller ID message is received, the Caller ID message will not appear.
- When the call is received via a telephone company that does not offer Caller ID service, the caller's phone number and name does not appear. (This includes some international calls.)
- When the call is via a private branch exchange (PBX), the caller's phone number and name may not appear.

## Caller ID and CIDCW (Caller ID on Call Waiting)

You must subscribe to Caller ID services through your local telephone provider to use these features.

When the telephone rings, the Caller ID feature allows you to view the caller's name, phone number, date and time of call. With CIDCW (Caller ID on Call Waiting), you will hear a call waiting tone while you are on a call, and the Caller ID data is displayed. To accept the waiting call, press **talk/flash**. Additionally, you can dial a number stored in the Caller ID list or save data to your Phonebook locations.

### Important:

Memory locations for Caller ID messages and Phonebook locations (including Speed Dials) are common; you can store up to all 80 locations for each handset. A Caller ID message is not stored when you have stored 80 of the phonebook locations.

When you have stored all 80 of the phonebook locations and Caller ID messages in total, the earliest Caller ID message is overwritten.

The date and time received	10/12 11:20AM
Caller's name	Jane Smith
Caller's phone number	214-555-1234

When the Caller ID message is received, the display shows the caller's phone number along with the date and time. The incoming call information is stored in the Caller ID record. If the Caller ID service includes the caller's name, the name will appear in the display (up to 15 characters).

You may receive any one of the following messages:

When a private name is received; Private Name

When a private number is received; Private Number

When a unknown name is received; Unknown Name

When a unknown number is received; Unknown Number

When invalid data is received; Incomplete Data



Data errors appear as "I."

## Call Waiting Deluxe Features

Your phone gives you new options for call waiting. At the touch of a button, you can place the caller on hold, send them to your voice mail service, or conference them into your current call. You must subscribe to Call Waiting and Call Waiting Deluxe to use these features. Not all features are available in all areas. Check with your local telephone company for details.

- 1) When you receive a Call Waiting call, press **menu/clear** for a list of options.
- 2) Press  $\Delta$ /**vol**/ $\wedge$  or  $\Delta$ /**vol**/ $\vee$  to select CW Deluxe, and then press **select**/ $\boxtimes$ /**audio tone**.
- 3) Press  $\Delta$ /**vol**/ $\wedge$  or  $\Delta$ /**vol**/ $\vee$  or the number keypad (**1-7**) to select an option.

**Ask to Hold** - A prerecorded message states that user will be available shortly, and the call is place on hold.

**Tell Busy** - A prerecorded message tells the caller you are busy, and the waiting call is disconnected.



- To activate features, select CW On/CWDX On in the CIDCW option. See page 23.
- If you don't press a key within 30 seconds while in the operation, the phone back to a call. To return back to a call, press **talk/flash**.



• Check with your local telephone company for a full list of options.

• The number of calls from the same Caller ID appears next to the received time. Once you view the new message, the number will disappear.

**Forward Call** - The caller is sent to your voice mail box, if available.

**Answer/Drop 1** - Disconnects the first call, and connects to the new caller.

**Conference** - Starts a conference call with your first and second callers.

**Drop First/Drop Last** - During a conference call, allows you to choose to drop the first or last caller.

4) Press **select**/**/audio tone**. A confirmation screen will appear, and the phone returns to the call.

## Viewing the Caller ID List



The Caller ID list stores information for incoming calls - even unanswered calls.



You can store up to 80 Caller ID messages and phonebook locations (including Speed Dials) for each handset. You can view the Caller ID list through the handset during a call or when the phone is in standby mode.

1) Press **cid**.

The summary screen appears. The screen shows the number of new messages and total messages.

2) To view the Caller ID messages in historical order (newest to oldest or from oldest to newest), use,

 **/vol**/ to scroll through the messages from the

latest to the earliest, or  **/vol**/ to scroll back through the messages.

To view the Caller ID messages with alphabetical search, press the number key pad (**2-9** and **0**) with the letter associated with the first letter of the desired message.

Caller ID
New : 5
Total: 25





Once you view the Caller ID list with alphabetical search, you cannot switch back to historical order unless you exit and re-enter the operation.

3) To finish the viewing operation, press **end** (or **cid** during a call).

### Deleting Information from the Caller ID List

- 1) When the phone is in standby mode, view the Caller ID information to be deleted (see "Viewing the Caller ID List" on page 47).
- 2) Press **menu/clear**.
- 3) Press  $\Delta$ /**vol**/ $\wedge$  or  $\Delta$ /**vol**/ $\vee$  to select **Yes**.
- 4) Press **select**/ $\boxtimes$ /**audio tone**. You will hear a confirmation tone.

```

Delete Caller ID
▶ Yes
  No
  
```

### Deleting all Caller ID name/numbers

- 1) When the phone is in standby mode, press **cid**.
- 2) Press **menu/clear**. **Delete All?** appears.
- 3) Press  $\Delta$ /**vol**/ $\wedge$  or  $\Delta$ /**vol**/ $\vee$  to choose **Yes**.
- 4) Press **select**/ $\boxtimes$ /**audio tone**. You will hear a confirmation tone.

```

Caller ID
New : 5
Total: 25
  
```

```

Delete All?
  Yes
▶ No
  
```



- During a call, don't press **end** or the call will disconnect.

- Once the Caller ID data has been deleted, the information cannot be retrieved



- When a long distance call has been set, "1" appears in the display.
- You cannot make a call from the Caller ID list if your phone is connected to a private branch exchange (PBX).

## Calling a Party from the Caller ID List

- 1) When the phone is in standby mode, select the Caller ID message (see "Viewing the Caller ID List" on page 47).
- 2) To have the phone dial a "1" before the displayed Caller ID number, press **\*/tone/←**. To have the phone dial the stored area code before the displayed Caller ID number, press **#/→**.
- 3) Press **talk/flash** or **(M)**. The displayed phone number dials automatically.

10/12 11:20AM Jane Smith 214-555-1234
---------------------------------------------

OR

- 1) Press **talk/flash** or **(M)**.
- 2) View the Caller ID message you want to dial (see "Viewing the Caller ID List" on page 47).
- 3) Press **select/☒/audio tone**. The displayed phone number will be dialed.

# Multi-Handset Features

The features in this section require a minimum of two handsets to operate. To add additional handsets to your system, see "Expanding Your Phone" on page 12.

## Using DirectLink Mode

In DirectLink Mode, a pair of handsets can function as two-way radios. You can have up to two pairs of handsets in DirectLink Mode at a time. DirectLink Mode does not interfere with the main base's ability to make or receive telephone calls. Use them at sporting events or while shopping to stay in contact with family members or friends. You must set both handsets to DirectLink Mode to activate this feature.

- 1) Press **menu/clear** and select DirectLink Mode menu.  
To enter DirectLink mode press [SELECT] appears.
- 2) Press **select/☒/audio tone** to enter DirectLink mode.  
You will hear a confirmation tone, and DirectLink Mode Complete appears.
- 3) To return to normal standby mode (cancel direct link), press **menu/clear** and then **select/☒/audio tone**, or return the handset to the cradle.

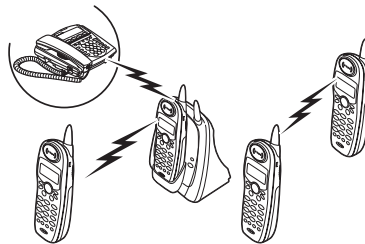

```
To enter  
DirectLink mode  
press [SELECT]
```

note

- Handsets can be in Direct Link mode while other handsets are in use.
- While a pair of handsets are in Directlink mode, they cannot be used to make or receive calls. Other handsets can still make and receive calls.

### DirectLink call

- 1) When the phone is in DirectLink standby mode, press **talk/flash** (example of DirectLink from handset #1).
- 2) Select the handset to which you wish to DirectLink with by pressing the number keys (**1-4**). Your handset will then page the other handset.
- 3) On the receiving handset, press **talk/flash**, or if Any Key Answer is on, press any number key, **\*/tone/←**, or **#/→**.
- 4) When you finish your conversation, press **end** on either handset. Return the handset to the cradle, or press **menu/clear**, and then **select/☒/audio tone** to return to normal standby mode (canceling DirectLink mode).

```
SUN 12:00A  📶  
Handset #1  
DirectLink Mode
```

```
To DirectLink  📶  
a handset  
Press [1-4]
```

```
DirectLink  📶  
←← Handset #1
```

# Intercom

The intercom feature lets you communicate with another handset without using the phone line.

## Making an Intercom Page

- 1) With the phone in standby mode, press **hold/transfer/int'com**.
- 2) Use  $\Delta$ /**vol**/ $\wedge$  or  $\Delta$ /**vol**/ $\vee$  to select the handset you want to talk with, and then press **select**/ $\boxtimes$ . If you select **#11**, all other handsets will be paged. An intercom tone sounds.  
To cancel intercom, press **end**.

To intercom	
▶ Handset	#2
Handset	#3

## Answering an Intercom Page

When the intercom page tone sounds, the display will show the ID of the handset that is paging.

- 1) Pick up the handset from the cradle. (If AutoTalk is enabled, the handset will automatically answer when you pick it up. Or if Any Key Answer is enabled, pressing a number key, **\*/tone/** $\leftarrow$ , or **\*/** $\rightarrow$  will answer the page.)
- 2) Press **talk/flash** or **hold/transfer/int'com**.

To hang up an intercom page, press **end** on either handset or return the handset to the cradle.



- If the party is busy, the handset returns to standby mode.
- If the party is out of range, "Unavailable" appears in the display, and the operation will be canceled.
- If you receive an outside/intercom call or page while selecting the other handset, the operation will be canceled.
- If you do not select a handset within thirty seconds, the operation will be canceled.
- If the party does not answer within one minute, the operation is canceled.



- If all handsets are paged, only the first party to answer the page will connect.
- If you do not select a handset within ten seconds, the operation will be canceled.

## Call Transfer Feature

The call transfer feature allows you to transfer a call between two handsets.

- 1) During a call, press **hold/transfer/int'com**.
- 2) Use  $\Delta$ /**vol**/ $\wedge$  or  $\Delta$ /**vol**/ $\vee$  to select the handset you want to transfer the call to, then press **select/☒/ audio tone**.

The call will automatically be placed on hold, and a paging tone sounds.

To cancel the transfer, press **talk/flash** or  $\text{Ⓜ}$  on the initiating handset.

Hold, to transfer	
▶ Handset	#2
Handset	#3

## Answering a Call Transfer Page

When the page tone sounds, the display will show the ID of the handset that is transferring the call.

- 1) Pick up the handset from the cradle. (If AutoTalk is enabled, the handset will automatically answer when you pick it up. Or if Any Key Answer is enabled, pressing a number key, **\*/tone/←**, or **\*/→** will answer the page.)
- 2) Press **talk/flash** or **intcom/hold**.

## Accepting the call transfer

After answering the page, if you want to accept the call and speak to the outside caller, press **talk/flash**.

# Room/Baby Monitor

This feature allows you to monitor sounds in another room. Place a handset in the room you wish to monitor; it will function as a microphone. A second handset can be set to function as a remote speaker, allowing you to monitor sounds in the room.

## Using Room/Baby Monitor

- 1) Press **menu/clear** and enter the Room Monitor menu. Listen to; appears.
- 2) Select the handset you want to monitor by using **▲/vol/▲** or **▲/vol/▼**.
- 3) Press **select/✉/audio tone**.  
RoomMonitor appears, and you hear sounds in the room where the handset is installed.
- 4) To turn off the Room Monitor, press **end** or return the handset to the cradle.

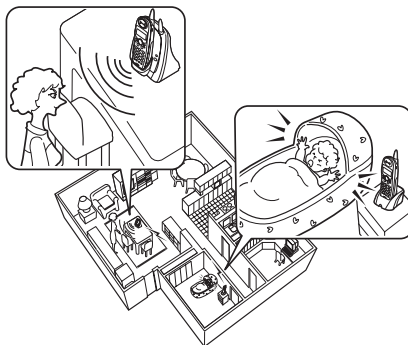

```
DirectLink Mode
▶ Room Monitor
Handset Setup
```

note

- This feature only works when both handsets are within the range of the base.
- If the party is out of range, **Unavailable** appears in the display, and the operation will be canceled.
- While a pair of handsets are in Room/Baby Monitor mode, they cannot be used to make or receive calls. Other handsets can still make and receive calls.

## Note on Power Sources

### **Power Failure**

During the period that the power is off you will not be able to make or receive calls with the telephone.

### **Battery replacement and handling**

When the operating time becomes short, even after the battery is recharged, please replace the battery. With normal usage, your battery should last about one year. Please contact your place of purchase or the Uniden Parts Department for a replacement battery.

### **Warning**

To avoid the risk of personal injury or property damage from fire or electrical shock, only use the Uniden battery model and Uniden adapter model specifically designated for this product.

#### Caution

- Use only the specified Uniden battery pack (BT-446).
- Do not remove the batteries from the handset to charge them.
- Never throw the battery into a fire, disassemble them, or heat them.
- Do not remove or damage the battery casing.



## Low battery alert

When the battery pack is very low, the phone is programmed to eliminate functions in order to save power.

The battery pack needs to be charged when:

- The empty battery icon appears.
- Low Battery appears in the display.

If the phone is in standby mode, none of keys will operate. If you are on a call, complete your conversation as quickly as possible, and return the handset to the cradle.

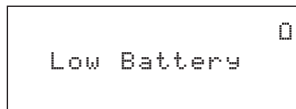

## Cleaning the battery charging contacts

To maintain a good charge, clean the charging contacts on the handset once a month. Dampen a cloth with plain water. Gently rub the damp cloth over the charging contacts until all visible dirt is removed. Dry the contacts thoroughly before returning the handset to the base.

**Caution:** Do not use paint thinner, benzene, alcohol, or other chemical products. Doing so may discolor the surface of the telephone and damage the finish.

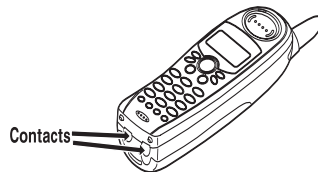

Even when the battery pack is not being used, it will gradually discharge over a long period of time. For optimum performance, be sure to return the handset to the base unit after each telephone call.

# General Information

The phone complies with FCC Parts 15 and 68. Operating temperature:  
0 °C to +50 °C (+32 °F to +122 °F)

## AC Adapter Information

AC Adapter part number: AD-800  
Input Voltage: 120 AC 60Hz  
Output Voltage: 9V DC 350mA

## Battery Information

Battery part number: BT-446  
Capacity: 800mAh, 3.6V



- To avoid damage to the phone use only Uniden AD-800 and BT-446 with your phone.
- If the handset is left off of the base, the actual Talk mode duration will be reduced respective to the amount of time the handset is off the base.

Recharge your phone on a regular basis by returning the handset to the base after each phone call. When the operating time becomes short even after the battery is recharged, please replace the battery. With normal usage, the battery should last about one year.

A replacement Uniden adapter or battery may be purchased by contacting the Uniden Parts Department (800) 554-3988. Hours are from 8:00 a.m. to 5:00 p.m. Central Time, Monday through Friday, or **[www.uniden.com](http://www.uniden.com)**.

Specifications, features, and availability of optional accessories are all subject to change without prior notice.

# Troubleshooting

If your phone is not performing to your expectations, please try these simple steps first.

Symptom	Suggestion
The <b>charge</b> LED won't illuminate when the handset is placed in the cradle.	<ul style="list-style-type: none"> <li>• Make sure the AC adapter is plugged into the base or the charger (if you have more than one handset) and wall outlet.</li> <li>• Make sure the handset is properly seated in the cradle.</li> <li>• Make sure the charging contacts on the handset are clean.</li> </ul>
The audio sounds weak.	<ul style="list-style-type: none"> <li>• Move the handset and/or base away from metal objects or appliances and try again.</li> <li>• Make sure that you are not too far from the base.</li> </ul>
Can't make or receive calls.	<ul style="list-style-type: none"> <li>• Make sure that you are not too far from the base.</li> <li>• Make sure the line is not in use. If an out call is already using a line, you cannot use that line to make another outside call.</li> <li>• Check both ends of the base telephone line cord.</li> <li>• Make sure the AC adapter is plugged into the base and wall outlet.</li> <li>• Disconnect the AC adapter for a few minutes, and then reconnect it.</li> <li>• Change the Digital Security Code (see page 15).</li> </ul>
The handset doesn't ring or receive a page.	<ul style="list-style-type: none"> <li>• Make sure that you are not too far from the base.</li> <li>• Charge the batteries in the handset for 15-20 hours by placing the handset on the base or charging cradle.</li> <li>• Change the Digital Security Code (see page 15).</li> </ul>
Severe noise interference.	<ul style="list-style-type: none"> <li>• Keep the handset away from microwave ovens, computers, remote control toys, wireless microphones, alarm systems, intercoms, room monitors, fluorescent lights, and electrical appliances.</li> <li>• Move to another location or turn off the source of interference.</li> </ul>

Symptom	Suggestion
The Caller ID does not display.	<ul style="list-style-type: none"> <li>• The call was placed through a switchboard.</li> <li>• Call your local telephone company to verify your Caller ID service is current. There may be a problem with your Caller ID service.</li> </ul>
You cannot register the handset at the base.	<ul style="list-style-type: none"> <li>• Charge the battery pack for 15-20 hours.</li> <li>• Change the Digital Security Code (see page 15).</li> </ul>
The handset doesn't communicate with other handsets.	<ul style="list-style-type: none"> <li>• Change the Digital Security Code (see page 15).</li> <li>• Make sure that you have registered all handsets.</li> </ul>
An extra handset can't join the conversation.	<ul style="list-style-type: none"> <li>• Make sure there are not 2 handsets already using the conference feature.</li> <li>• Make sure that another handset is not in privacy mode.</li> </ul>
Room Monitor feature does not work.	<ul style="list-style-type: none"> <li>• Make sure to place the handset(s) within the range of the base.</li> </ul>

# Liquid Damage

Moisture and liquid can damage your cordless phone. In case of accidental submersion, please read the following steps.

Case	Action
If the handset or base is exposed to moisture or liquid, but only affects the exterior plastic housing.	Wipe off the liquid, and use as normal.
If moisture or liquid has entered the plastic-housing (i.e. liquid can be heard in the phone or liquid has entered the handset battery compartment or vent openings on the base).	<p><b>Handset:</b></p> <ol style="list-style-type: none"> <li>1) Remove the battery cover and leave it off for ventilation.</li> <li>2) Remove the battery pack by disconnecting.</li> <li>3) Leave the battery cover off and the battery pack disconnected for at least 3 days.</li> <li>4) Once the handset is completely dry, reconnect the battery pack and the battery cover.</li> <li>5) Recharge the handset's battery pack for 20 hours before using again.</li> </ol> <p><b>Base:</b></p> <ol style="list-style-type: none"> <li>1) Disconnect the AC adapter from the base unit, cutting off electrical power.</li> <li>2) Disconnect the telephone cord from the base unit.</li> <li>3) Let dry for at least 3 days.</li> </ol> <p><b>IMPORTANT:</b> You must <b>unplug the telephone line while recharging the battery packs</b> to avoid charge interruption.</p> <p><b>CAUTION:</b> DO NOT use a microwave oven to speed up the drying process. This will cause permanent damage to the handset, base and the microwave oven.</p> <p>After following these steps, if your cordless telephone does not work, please send to:</p> <p style="text-align: center;">Uniden America Corporation Parts and Service Division 4700 Amon Carter Blvd. Ft. Worth TX 76155 1-800-554-3988. Monday through Friday 8 a.m. to 5 p.m. CST</p>

## Precautions!

Before you read anything else, please observe the following:

### Warning!

Uniden America Corporation DOES NOT represent this unit to be waterproof. To reduce the risk of fire, electrical shock, or damage to the unit, DO NOT expose this unit to rain or moisture.

### Rechargeable Nickel-Metal-Hydride Battery Warning

- This equipment contains a rechargeable Nickel-Metal-Hydride battery.
- Nickel is a chemical known to state of California to cause cancer.
- The rechargeable Nickel-Metal-Hydride battery contained in this equipment may explode if disposed of in a fire.
- Do not short-circuit the battery.
- Do not charge the rechargeable Nickel-Metal-Hydride battery used in this equipment in any charger other than the one designed to charge this battery as specified in the owner's manual. Using another charger may damage the battery or cause the battery to explode.

### Rechargeable Nickel-Metal-Hydride Batteries Must Be Recycled or Disposed of Properly

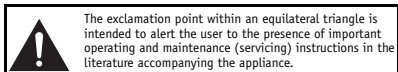

The exclamation point within an equilateral triangle is intended to alert the user to the presence of important operating and maintenance (servicing) instructions in the literature accompanying the appliance.

Uniden works to reduce lead content in our PVC coated cords in our products and accessories.

### Warning!

The cords on this product and/or accessories contain lead, a chemical known to the State of California to cause birth defects or other reproductive harm. **Wash hands after handling.**

### Important Safety Instructions

When using your telephone equipment, these basic safety precautions should always be followed to reduce the risk of fire, electrical shock, and injury to persons:

1. Read and understand all instructions.
2. Follow all warnings and instructions marked on the product.
3. Unplug this product from the wall outlet before cleaning. Use a dry cloth for cleaning without liquid or aerosol cleaners.
4. Do not use this product near water; for example, near a bathtub, wash bowl, kitchen sink or laundry tub, in a wet basement, or near a swimming pool.
5. Do not place this product on an unstable cart, stand, or table. The telephone may fall, causing serious damage to the unit.

6. Slots and openings in the cabinet and the back or bottom are provided for ventilation. To protect the product from overheating, these openings must not be blocked or covered. This product should never be placed near or over a radiator or heat register. This product should not be placed in a built-in installation unless proper ventilation is provided.
7. This product should be operated only from the type of power source indicated on the marking label. If you are not sure of the type of power supply to your home, consult your dealer or local power company.
8. Do not allow anything to rest on the power cord. Do not locate this product where the cord will be damaged by persons walking on it.
9. Do not overload wall outlets and extension cords, as this can result in the risk of fire or electrical shock.
10. Never push objects of any kind into this product through cabinet slots, as they may touch dangerous voltage points or short out parts that could result in a risk of fire or electric shock. Never spill liquid of any kind on the product.
11. To reduce the risk of electric shock, do not disassemble this product. Take it to qualified service personnel when service or repair work is required. Opening or removing covers may expose you to dangerous voltages or other risks. Incorrect reassembly can cause electric shock when the appliance is subsequently used.
12. Unplug this product from the wall outlet and refer servicing to qualified service personnel under the following conditions:
  - A. When the power supply cord is damaged or frayed.
  - B. If liquid has been spilled into the product.
  - C. If the product has been exposed to rain or water.
  - D. If the product does not operate normally when following the operating instructions. (Adjust only those controls that are covered by the operating instructions. Improper adjustment of other controls may result in damage and will often require extensive repair work by a qualified technician.)
  - E. If the product has been dropped or the cabinet has been damaged.
  - F. If the product exhibits a distinct change in performance.
13. Do not use the telephone to report a gas leak in the vicinity of the leak.

### Additional Battery Safety Precautions

*Caution! To reduce the risk of fire or injury to persons by the battery, read and follow these instructions:*

1. Use only the Uniden battery pack specified in the owner's manual.
2. Do not dispose of the battery pack in a fire. The cell may explode. Check the Nickel Metal Hydride battery disposal package insert for disposal instructions.
3. Do not open or mutilate the battery pack. Released electrolyte is corrosive and may cause damage to the eyes or skin. It may be toxic if swallowed.
4. Exercise care in handling the battery in order not to short the battery with conducting materials such as rings, bracelets, and keys. The battery or conductor may overheat and cause burns.

5. Charge the battery pack provided with or identified for use with this product only in accordance with the instructions and limitations specified in the owners manual provided for this product.
6. Observe proper polarity orientation between the battery pack and battery charger.
7. Batteries must be disconnected and removed from the product before shipment to prevent accidental operation during transport. Any batteries transported with the product must be separately secured and cushioned with any exposed terminals covered to prevent their breakage, leakage, movement within the packaging, or short circuits. Failure to follow these recommendations for shipment may result in serious damage and/or personal injury during transport and may be against the U.S. Department of Transportation (DOT), International Civil Aviation Administration (ICAO), International Air Transport Association (IATA), and/or the International Maritime Organization (IMO) regulations.

### SAVE THESE INSTRUCTIONS!

## Important Electrical Considerations

Unplug all electrical appliances when you know an electrical storm is approaching. Lightning can pass through your household wiring and damage any device connected to it. This phone is no exception.

## The FCC Wants You To Know

Changes or modifications to this product not expressly approved by Uniden, or operation of this product in any way other than as detailed by the owner's manual, could void your authority to operate this product. Your telephone complies with Part 68 of FCC Rules. You must, upon request, provide the FCC registration number and the REN to your telephone company. Both numbers are on the base unit.

### Note: You must not connect your phone to:

- coin-operated systems
- most electronic key telephone systems

This device complies with part 15 of the FCC rules. Operation is subject to the following two conditions: (1) This device may not cause harmful interference, and (2) This device must accept any interference received, including interference that may cause undesired operation. Privacy of communications, may not be ensured when using this phone.

## Range

Your new phone is designed to achieve the maximum possible range by transmitting and receiving according to the highest specifications set forth by the FCC. We have rated this phone to operate at a maximum distance with the qualification that the range depends upon the environment in which the telephone is used. Many factors limit range, and it would be impossible to include all the variables in our rating. The Maximum Range rating of this phone is meant to be used as a means of comparison against other range claims.

## Telephone Line Problems

The FCC has granted the telephone company the right to disconnect service in the event that your phone causes problems on the telephone

line. Also, the telephone company may make changes in facilities and services which may affect the operation of your unit. However, your telephone company must give adequate notice in writing prior to such actions to allow you time for making necessary arrangements to continue uninterrupted service. If you are having trouble with your telephone service, you must first disconnect your phone to determine if it is the cause of your problem. If you determine that it is the cause, you must leave it disconnected until the trouble has been corrected.

### Radio Interference

Radio interference may occasionally cause buzzing and humming in your cordless handset, or clicking noises in the base. This interference is caused by external sources such as TV, refrigerator, vacuum cleaner, fluorescent lighting, or electrical storm. Your unit is NOT DEFECTIVE. If these noises continue and are too distracting, please check around your home to see what appliances may be causing the problem. In addition, we recommend that the base not be plugged into a circuit that also powers a major appliance because of the potential for interference. Be certain that the antenna on the unit is fully extended when needed. In the unlikely event that you consistently hear other voices or distracting transmissions on your phone, you may be receiving radio signals from another cordless telephone or other source of interference. If you cannot eliminate this type of interference, you need to change to a different channel.

Finally, it should be noted that some cordless telephones operate at frequencies that may cause interference to nearby TVs and VCRs. To minimize or prevent such interference, the base of the cordless telephone should not be placed near or on top of a TV or VCR. If interference is experienced, moving the cordless telephone farther away from the TV or VCR will often reduce or eliminate the interference.

### More than One Cordless Telephone

If you want to use more than one cordless telephone in your home, they must operate on different channels. Press the channel key to select a channel that provides the clearest communication.

### Cordless Telephone Privacy

Cordless telephones are radio devices. Communications between the handset and base of your cordless telephone are accomplished by means of radio waves which are broadcast over the open airways. Because of the inherent physical properties of radio waves, your communications can be received by radio receiving devices other than your own cordless telephone unit. Consequently, any communications using your cordless telephone may not be private.

## Installation Considerations

### Selecting a Location

Before choosing a location for your new phone, there are some important guidelines you should consider:

- The location should be close to both a phone jack and continuous power outlet. (A continuous power outlet is an AC outlet which does not have a switch to interrupt its power.)
- Keep the base and handset away from sources of electrical noise such as motors or fluorescent lighting.
- Be sure there is sufficient space to fully extend the base antenna.
- The base can be placed on a desk or tabletop or mounted on a standard telephone wall plate.
- You should charge your new phone for 15-20 hours before completing the installation or using the handset.

### Telephone Line Outlets

There are two types of phone outlets:

#### Modular Jack

Most phone equipment available now uses modular jacks. Phone cords are fitted with a molded plastic connector which plugs into this type of jack. If you do not have modular phone jacks, contact your local telephone company for information about their installation.

#### Hardwired Jack

Some equipment is wired directly to a phone jack, and these types of installations require a modular jack converter. This type of installation is not difficult; however, you should contact your Uniden telephone dealer or a telephone supply store for advice about the proper adapter or converter for your particular situation.

### Connecting the Telephone Cords

Consider these safety guidelines before connecting the telephone cords: Caution!

- *Never install telephone wiring during a lightning storm.*
- *Never touch uninsulated telephone wires or terminals unless the telephone line has been disconnected.*
- *Use caution when installing or modifying telephone lines.*

### Applying Power to the Base

This phone requires an AC outlet, without a switch to interrupt power, and the included AC adapter. To relieve strain on the DC plug when the phone is placed on a desk or table, wrap the power cord around the strain relief notch on the bottom of the base.

*NOTE: Place the power cord so that it does not create a trip hazard, or where it could become chafed and create a fire or other electrical hazards.*

## One Year Limited Warranty

Important: Evidence of original purchase is required for warranty service. WARRANTY: UNIDEN AMERICA CORPORATION ("Uniden") ELEMENTS OF WARRANTY: Uniden warrants, for one year, to the original retail owner, this Uniden Product to be free from defects in materials and craftsmanship with only the limitations or exclusions set out below.

WARRANTY DURATION: This warranty to the original user shall terminate and be of no further effect 12 months after the date of original retail sale. The warranty is invalid if the Product is (A) damaged or not maintained as reasonable or necessary, (B) modified, altered, or used as part of any conversion kits, subassemblies, or any configurations not sold by Uniden, (C) improperly installed, (D) serviced or repaired by someone other than an authorized Uniden service center for a defect or malfunction covered by this warranty, (E) used in any conjunction with equipment or parts or as part of any system not manufactured by Uniden, or (F) installed or programmed by anyone other than as detailed by the owner's manual for this product.

STATEMENT OF REMEDY: In the event that the product does not conform to this warranty at any time while this warranty is in effect, warrantor will either, at its option, repair or replace the defective unit and return it to you without charge for parts, service, or any other cost (except shipping and handling) incurred by warrantor or its representatives in connection with the performance of this warranty. Warrantor, at its option, may replace the unit with a new or refurbished unit. THE LIMITED WARRANTY SET FORTH ABOVE IS THE SOLE AND ENTIRE WARRANTY PERTAINING TO THE PRODUCT AND IS IN LIEU OF AND EXCLUDES ALL OTHER WARRANTIES OF ANY NATURE WHATSOEVER, WHETHER EXPRESS, IMPLIED OR ARISING BY OPERATION OF LAW, INCLUDING, BUT NOT LIMITED TO ANY IMPLIED WARRANTIES OF MERCHANTABILITY OR FITNESS FOR A PARTICULAR PURPOSE. THIS WARRANTY DOES NOT COVER OR PROVIDE FOR THE REIMBURSEMENT OR PAYMENT OF INCIDENTAL OR CONSEQUENTIAL DAMAGES. Some states do not allow this exclusion or limitation of incidental or consequential damages so the above limitation or exclusion may not apply to you.

LEGAL REMEDIES: This warranty gives you specific legal rights, and you may also have other rights which vary from state to state. This warranty is void outside the United States of America and Canada. PROCEDURE FOR OBTAINING PERFORMANCE OF WARRANTY: If, after following the instructions in the owner's manual you are certain that the Product is defective, pack the Product carefully (preferably in its original packaging). Disconnect the battery from the Product and separately secure the battery in its own separate packaging within the shipping carton. The Product should include all parts and accessories originally packaged with the Product. Include evidence of original purchase and a note describing the defect that has caused you to return it. The Product should be shipped freight prepaid, by traceable means, to warrantor at:

#### Uniden America Corporation

Parts and Service Division  
4700 Amon Carter Blvd.  
Fort Worth, TX 76155

(800) 297-1023, 8 a.m. to 5 p.m. CST, Monday through Friday

# I.C. Notice

## TERMINAL EQUIPMENT

**NOTICE:** This equipment meets the applicable Industry Canada Terminal Equipment Technical Specifications. This is confirmed by the registration number. The abbreviation, IC, before the registration number signifies that registration was performed based on a Declaration of Conformity indicating that Industry Canada technical specifications were met. It does not imply that Industry Canada approved the equipment.

**NOTICE:** The Ringer Equivalence Number (REN) for this terminal equipment is marked on the equipment itself. The REN assigned to each terminal equipment provides an indication of the maximum number of terminals allowed to be connected to a telephone interface. The termination on an interface may consist of any combination of devices subject only to the requirement that the sum of the Ringer Equivalence Numbers of all the devices does not exceed five.

## RADIO EQUIPMENT

The term "IC:" before the radio certification number only signifies that Industry Canada technical specifications were met.

Operation is subject to the following two conditions: (1) this device may not cause interference, and (2) this device must accept any interference, including interference that may cause undesired operation of the device. "Privacy of communications may not be ensured when using this telephone".



# Index

- A**
- Animal sounds . . . . . 18
  - Anykey Answer . . . . . 20
  - Area Code . . . . . 23
  - Audio Tone . . . . . 31
  - AutoTalk . . . . . 19
- B**
- Banner . . . . . 20
  - Battery
    - Preparing and charging . . . . . 8
    - Replacement and handling. . . . . 55
  - Beltclip . . . . . 15
- C**
- Call transfer feature . . . . . 53
  - Caller ID
    - Call Waiting . . . . . 28
    - Caller ID services . . . . . 45
    - Calling . . . . . 49
    - CIDCW . . . . . 45
    - CWDX . . . . . 46
    - Deleting . . . . . 48
    - Setting . . . . . 23
    - Storing . . . . . 40
    - Viewing . . . . . 47
  - Clarity Booster . . . . . 33
  - Clock . . . . . 22
  - Conferencing . . . . . 34
- D**
- Deluxe Call Waiting Features . . . . . 46
  - De-register the Handset . . . . . 25
  - Dial mode . . . . . 24
  - Digital security code . . . . . 15
  - DirectLink . . . . . 50
  - Distinctive ringer . . . . . 19
- E, F, G, H, I, J**
- Earpiece volume . . . . . 30
  - Expanding your phone . . . . . 12
  - General information . . . . . 57
  - Hands-free conversation . . . . . 26
  - Headset installation . . . . . 15
  - Hold . . . . . 28
  - I.C. notice . . . . . 63
  - Important safety instructions. . . . . 61
  - Intercom . . . . . 52
- K, L, M, N, O**
- Key touch tone . . . . . 21
  - Language . . . . . 21
  - Liquid damage . . . . . 60
  - Making a call . . . . . 26
  - Mute . . . . . 31
- P, Q**
- Phonebook
    - Copying . . . . . 44
    - Editing . . . . . 43
    - Erasing . . . . . 43
    - Making calls . . . . . 42
    - Storing . . . . . 37
    - Viewing . . . . . 41
  - Precautions . . . . . 61
  - Privacy Mode . . . . . 33
- R**
- Receiving a call . . . . . 27
  - Redialing a call . . . . . 29
  - Register the handset . . . . . 14
  - Ring options . . . . . 18
  - Ringer
    - mute . . . . . 31
  - Room/baby monitor . . . . . 54
- S**
- Setting up
    - base unit . . . . . 9
    - Handset . . . . . 8
    - Menu options . . . . . 17
    - Telephone Line . . . . . 9
  - Speed dialing . . . . . 42
- T, U, V, W, X, Y, Z**
- Transferring a call . . . . . 53
  - Troubleshooting . . . . . 58
  - Voice Mail Access . . . . . 34
  - Voice Mail Tone . . . . . 35
  - Warranty . . . . . 62

# Memory List

	Name	Phone No.		Name	Phone No.		Name	Phone No.
1			35			69		
2			36			70		
3			37			71		
4			38			72		
5			39			73		
6			40			74		
7			41			75		
8			42			76		
9			43			77		
10			44			78		
11			45			79		
12			46			80		
13			47					
14			48					
15			49					
16			50					
17			51					
18			52					
19			53					
20			54					
21			55					
22			56					
23			57					
24			58					
25			59					
26			60					
27			61					
28			62					
29			63					
30			64					
31			65					
32			66					
33			67					
34			68					

# Memo

**At Uniden, we'll take care of you!**

If you need any assistance with this product, please call our Customer Hotline at

**1-800-297-1023**

**PLEASE DO NOT RETURN THIS PRODUCT TO THE PLACE OF PURCHASE.**

Our Uniden representatives will be happy to help you with any matters regarding the operation of this unit, available accessories, or any other related matters.

Thank you for purchasing a Uniden product.

Hours: M-F 8:00 AM to 5:00 PM CST.

**www.uniden.com**



For information on the accessibility features of this product, please call  
**1-800-874-9314 (V/TTY)**

**Uniden®**

May be covered under one or more of the following U.S. patents:

4,523,058	4,595,795	4,797,916	5,381,460	5,426,690	5,434,905
5,491,745	5,493,605	5,533,010	5,574,727	5,581,598	5,650,790
5,660,269	5,661,780	5,663,981	5,671,248	5,696,471	5,717,312
5,732,355	5,754,407	5,758,289	5,768,345	5,787,356	5,794,152
5,801,466	5,825,161	5,864,619	5,893,034	5,912,968	5,915,227
5,929,598	5,930,720	5,960,358	5,987,330	6,044,281	6,070,082
6,125,277	6,253,088	6,314,278	6,418,209		

FOR  
ACCESSORIES,  
GO ONLINE @  
WWW.UNIDEN.COM

**REGISTER ONLINE TODAY!**

**THANK YOU FOR BUYING A UNIDEN PRODUCT.**

A World Without Wires | **Uniden**<sup>®</sup>

## Free Manuals Download Website

<http://myh66.com>

<http://usermanuals.us>

<http://www.somanuals.com>

<http://www.4manuals.cc>

<http://www.manual-lib.com>

<http://www.404manual.com>

<http://www.luxmanual.com>

<http://aubethermostatmanual.com>

Golf course search by state

<http://golfingnear.com>

Email search by domain

<http://emailbydomain.com>

Auto manuals search

<http://auto.somanuals.com>

TV manuals search

<http://tv.somanuals.com>