

Uniden®

OWNER'S MANUAL

DCT 5280/DCT 5280-2

**BUY AN
ADDITIONAL
HANDSET FOR
THE DCT 5280
SERIES**
(see back
for details)



2.4GHz

MULTI HANDSET CORDLESS SYSTEM

**QUICK & EASY
SET-UP GUIDE**

SEE QUICK REFERENCE GUIDE SECTION download from www.Somanuals.com. All Manuals Search And Download.

EASILY REGISTER THIS
PRODUCT ONLINE AT
WWW.UNIDEN.COM

www.uniden.com

Contents

WELCOME/FEATURES	3	Editing or Erasing a Stored Name, Phone Number, Distinctive Ring, and Speed Dial	43
QUICK REFERENCE GUIDE	5	Chain Dialing	44
CONTROLS AND FUNCTIONS	6	CALLER ID	45
DISPLAY AND ICONS	8	Viewing the Caller ID List	46
ABOUT SOFT KEY FUNCTION/TERMINOLOGY	9	Deleting Information from the Caller ID List	47
GETTING STARTED	10	Using the Caller ID Message List	48
Read this First	10	Call Waiting Deluxe Features	49
Checking the Package Contents	11	THE INTEGRATED ANSWERING DEVICE	50
Setting up the Phone	12	Turning the Answering System On/Off	51
Mounting the Base Unit on a Wall	16	Setting up your Answering System	51
DCT5280 Flow Chart	18	Using your Answering System	58
About the Menu	20	Remote Operation	61
Setting up the Menu	23	EXPANDING YOUR PHONE	64
BASICS	31	Connecting the Charger	64
Making and Receiving Calls	31	Register the Handset	65
Placing a Call on Hold	32	Using the DirectLink Mode	65
Redialing a Call	33	4-Way Conferencing	66
Ringer Mute (temporarily)	34	Intercom/Call Transfer Feature	67
Adjusting the Earpiece and Handset Speaker Volume	34	Replacing the Base	68
Mute Microphone	34	ADDITIONAL INFORMATION	69
Tone Dialing Switch-over	35	Changing the Digital Security Code	69
Traveling Out-of-Range	35	Installing the Beltclip	69
Clarity Booster	35	Headset Installation	69
3-way Conferencing	36	Note on Power Sources	70
Intercom/Call Transfer Feature	36	Maintenance	70
Flash and Call Waiting	37	General Information	71
New Message LED	37	TROUBLESHOOTING	72
PHONEBOOK	38	Liquid Damage	74
Storing Phone Numbers, Names, Distinctive Rings, and Speed Dial	38	PRECAUTIONS & WARRANTY	75
Steps for Entering Names and Special Characters	40	I.C. NOTICE	77
Viewing the Phonebook	42	INDEX	78
Making Calls Using the Phonebook	43	REMOTE OPERATION CARD	79
Speed Dialing	43		

Welcome

Congratulations on your purchase of the Uniden DCT5280 series Multi Handset Cordless System telephone. This unit is different from conventional cordless telephones. When the base unit is connected to AC power and a telephone line, it can support up to 4 handsets. Using extra handsets, you can establish a 4-way conference call (2 H/S- Base Speaker Phone-an outside line, or 3 handsets- an outside line). Additionally, with 4-way conference using 2 handsets, another 2 handsets can establish an intercom call. You can now place a fully featured cordless handset anywhere in your home or office where AC power is available to connect the handset chargers.

Note: Some illustrations in this manual may differ from the actual unit for explanation purposes.



As an Energy Star® Partner, Uniden has determined that this product or product models meets the Energy Star® guidelines for energy efficiency. Energy Star® is a U.S. registered mark.

Note: Energy Star® applies to DCT5280 only.

Features

- 2.4GHz Frequency Hopping Spread Spectrum
- Integrated Answering Device (Trilingual Announcement Option)
- 4 Multi-Handset Expandability
- Hands Free Speakerphone in the Handset
- Call Waiting Deluxe
- Caller ID/Caller ID on Call Waiting
- 100 Dynamic Memory Location (Phonebook & Caller ID)
- Trilingual Function Menus (English-French-Spanish) (Handset)
- Intercom/Call Transfer
- 16 Distinctive Ring Options (8 ringer tones and 8 melody ringers)
- Mute Feature
- Flash and Pause
- 88 Channel Auto Scan
- DirectLink™ Mode
- Battery Level Indicator
- Clock Display

The DCT5280 series features include **AutoTalk™** and **AutoStandby™**. AutoTalk allows you to answer a call by just removing the handset from the cradle so you don't have to waste time pushing buttons. AutoStandby allows you to hang up by simply returning the handset to the cradle.

To protect you against mis-billed calls, which might result from your phone being activated by other equipment, the DCT5280 series has **Random Code™** digital security, which automatically selects one of over approx. 130,000 digital security codes for the handset and base.

Frequency Hopping Spread Spectrum (FHSS) technology improves calling range and clarity, and eliminates cross talk. Because it rapidly changes transmission frequencies within the 2.4GHz bandwidth, this cordless phone helps reduce the possibility of eavesdropping.

DirectLink™ Mode is used when you have 2 or more handsets. You can use your handsets as transceivers.

Be sure to visit our web site: www.uniden.com

Uniden® is a registered trademark of Uniden America Corporation.

AutoTalk, AutoStandby, DirectLink, and Random Code are trademarks of Uniden America Corporation.

Step 1 Charging the Batteries

INSTALL THE AA BATTERIES

- 1 Remove the cover.

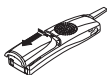

- 2 Install the batteries, observing the correct polarity.



- 3 Replace the cover.



PLUG INTO AC POWER

- 1 Plug the AC adapter cord into the base unit and then to a 120V AC outlet.

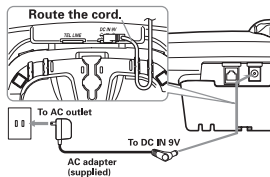

- 2 Place the handset in the base.

Note: You must charge the batteries continuously for 17-20 hours before using the phone.

Step 2 Connecting

CONNECT TO A PHONE LINE

When the handset batteries are fully charged, plug the telephone cord into the base unit and then into a telephone wall jack.

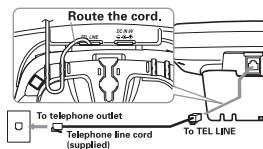

Your phone is set for tone dialing. If your local network requires pulse dialing, please see "Setting the Dial Mode" on page 30.

Step 3 Using the Phone

TO SELECT CALLER ID OPTIONS

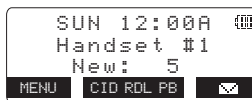

- 1 Press the **MENU** soft key in the standby mode.
- 2 Press **volume/▲** or **▼** to select "Global Setup", then the **OK** soft key.
- 3 Press **volume/▲** or **▼** to select "CIDCW", then the **OK** soft key.
- 4 Press **volume/▲** or **▼** to select "Cw On/CWDX On", "Cw On/CWDX Off", or "Cw Off/CWDX Off", then the **OK** soft key.

TO CHOOSE THE LANGUAGE

- 1 Press the **MENU** soft key in the standby mode.
- 2 Press **volume/▲** or **▼** to select "Handset Setup", then the **OK** soft key.
- 3 Press **volume/▲** or **▼** to select "Language", then the **OK** soft key.
- 4 Press **volume/▲** or **▼** to choose a Language, then the **OK** soft key.

Step 4 Setting up Answering System

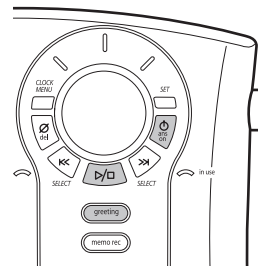

TO TURN THE ANSWERING SYSTEM ON/OFF

Each time **ans on** is pressed, the answering mode is switched between On and Off.

TO SET GREETING MESSAGE

- 1 Press and hold **greeting**.
- 2 Start recording your message. Position yourself as near to the base as possible.
- 3 When finished, press **greeting** or **▷/□**.

Controls and Functions

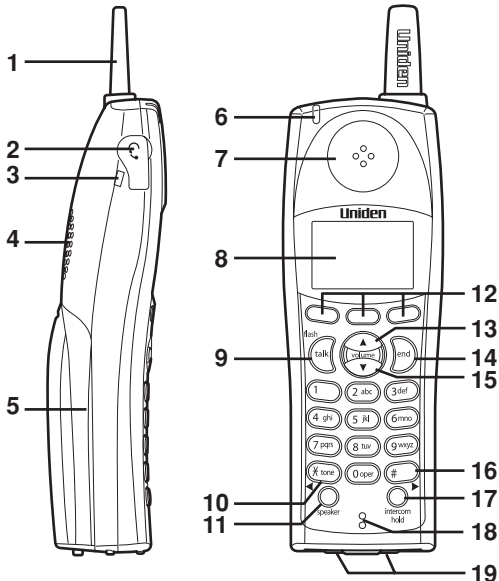

1. Handset Antenna
2. Headset Jack Cover
3. Beltclip Hole
4. Hands Free Speaker
5. Handset Battery Compartment
6. New Message LED
7. Handset Earpiece
8. LCD Display
9. Talk/flash Key
10. * /tone/◀ Key
11. Speaker Key
12. Soft keys
13. Volume/▲ (up) Key
14. End Key
15. Volume/▼ (down) Key
16. #/▶ Key
17. Intercom/hold Key
18. Handset Microphone
19. Handset Charging Contacts

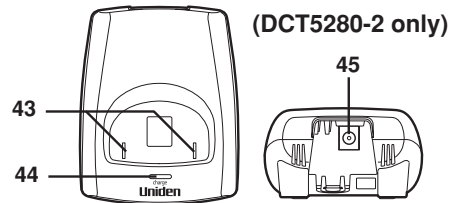
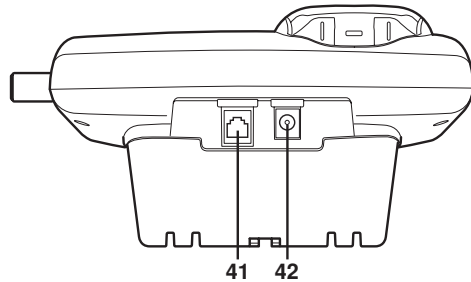
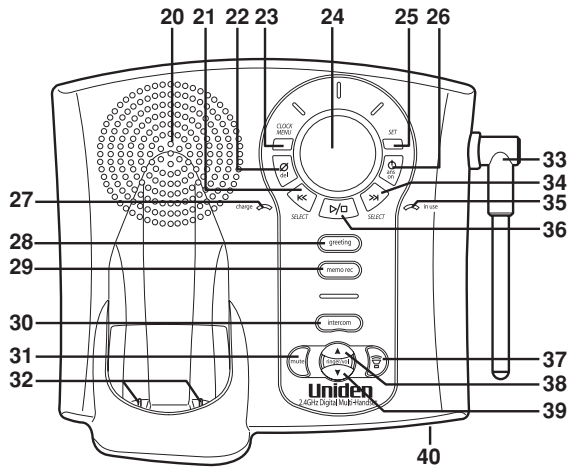

- 20. Base Speaker
- 21. K<< (repeat)/SELECT Key
- 22. Ø del (delete) Key
- 23. CLOCK/MENU Key
- 24. Message Counter Display
- 25. SET Key
- 26. ☉ ans (answer) on Key
- 27. Charge LED
- 28. Greeting Key
- 29. Memo rec (record) Key

- 30. Intercom Key
- 31. Mute Key
- 32. Base Charging Contacts
- 33. Base Antenna
- 34. >>X (skip)/SELECT Key
- 35. In use LED
- 36. ▷/□ (play/stop) Key
- 37. ☎ (talk) Key/speaker LED

- 38. Ringer/vol (volume) ▲ (up) Key
- 39. Ringer/vol (volume) ▼ (down) Key
- 40. Microphone
- 41. Telephone Input
- 42. DC Power Input
- 43. Charging Contacts (DCT5280-2 only)
- 44. Charge LED (DCT5280-2 only)
- 45. DC Power Input (DCT5280-2 only)

Display and Icons

Example of the standby mode display

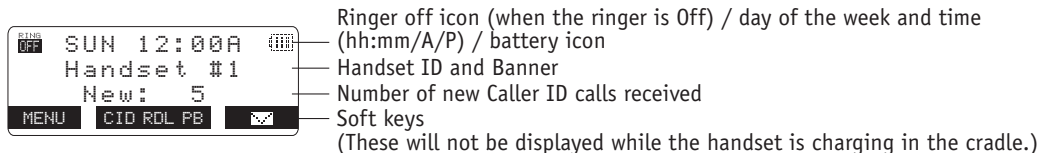

ICON	STATUS	DESCRIPTION
	Standby/Talk	Battery icons indicate the handset battery status. This icon cycles depending on the battery status (empty, low, medium, and full). ⊗ indicates that the batteries installed are not for use with this phone, remove the batteries immediately.
	Standby	Ringer off icon indicates that ringer is set to Off.
	Standby	Handset Remote soft key is used to play an incoming message remotely.
	Talk	Mute icon appears when you mute the handset.
	Talk	Speaker icon appears when the handset speaker phone is used.
	Talk	Recording icon appears while recording a conversation.

About Soft Key Function

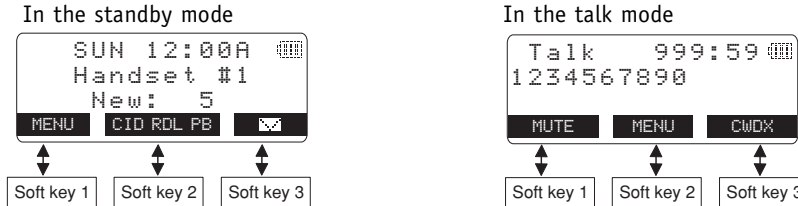

Soft key functions consists of soft key icons and soft keys (No. 1, 2, and 3). Each soft key corresponds to the icon displayed above, and each icon will be changed depending on the operation. Press the corresponding soft key to enter a menu, or select an item. In this manual, we refer to this combination of icons and keys as the soft key.

For example, you will use the soft keys when you want to:

- Access the main menu
- Set up CIDCW options
- Access Caller ID messages stored
- Store or edit phone numbers
- Redial one of the last three numbers dialed from the handset
- Etc....

Note: The soft keys will not appear while charging the handset.

Terminology

Throughout this manual, terms such as Standby and Talk Mode are used. Below is the terminology explanation.

Standby Mode - The handset is not in use, is off the cradle, and *talk/flash* or *speaker* has not been pressed. A dial tone is not present.

Talk Mode - The handset is not in the cradle and *talk/flash* or *speaker* has been pressed enabling a dial tone. "Talk" appears on the display.

Read this First

This cordless telephone must be set up before use. Follow these steps:

Step 1 (page 11)

Unpack the telephone and accessories.

Step 2 (page 12)

Next, choose the best location to set up the base unit.

Step 3 (page 13 to 17)

Then, insert the batteries into the handset. Connect the base unit. You must charge the batteries **for 17-20 hours before plugging into the phone line and using the phone.** Then set the dial mode.

Step 4 (page 18 to 30)

Finally, set the menu. You can set, for example: clock, CIDCW setting, area code, TAD menu, and Autotalk from the menu.

About the digital security code

This cordless telephone uses a digital security code to prevent unauthorized access to your base unit. This security code prevents other cordless handsets from making calls through your base unit. If you want to change the security code, see page 69.

Checking the Package Contents

Make sure you have received the following items in the package. If any of these items are missing or damaged, contact the Uniden Parts Department.

- Base unit (1)
- Handset [DCT5280 (1) / DCT5280-2 (2)*]
- AC adapter [DCT5280 (1) / DCT5280-2 (2)]
- Desk top / Wall Mount adapter (1)
- Rechargeable batteries [DCT5280 (2) / DCT5280-2 (4)]
- Long telephone cord (1)
- Short telephone cord (1)
- Beltclip [DCT5280 (1) / DCT5280-2 (2)]
- Charger (1) [DCT5280-2 only]

Also included:

- This Owner's Manual
- Other Printed Material

* For operations and restrictions on using multi handsets, read "Expanding Your Phone" on page 64.

Uniden Parts Department

(800) 554-3988

Hours: M-F 8:00 a.m. to 5:00 p.m. CST.

We can also be reached on the web at **www.uniden.com**.



If your home has specially wired alarm equipment connected to the telephone line, be sure that installing the system does not disable your alarm equipment.

If you have questions about what will disable alarm equipment, contact your telephone company or a qualified installer.

Setting up the Phone

Do the following steps:

- A. Choose the best location
- B. Install the AA batteries into the handset
- C. Connect the base unit
- D. Choose the dialing mode

A. Choose the best location

Before choosing a location for your new phone, read "Installation Considerations" on page 76. Here are some important guidelines you should consider:

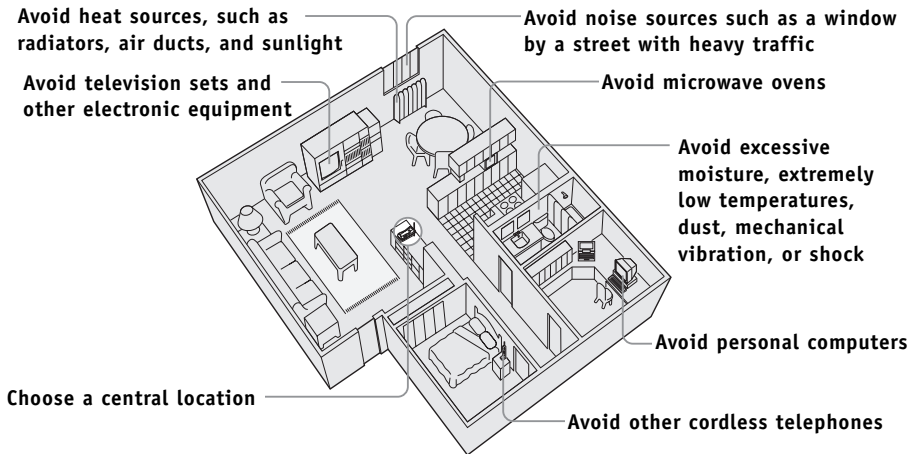

B. Install the AA batteries into the handset

Charge the batteries for at least 17-20 hours before plugging the phone line into your base unit.

- 1) Press down on the battery cover release and slide the cover down until it comes off.
- 2) Install the batteries supplied with your phone, observing correct + - polarity.
- 3) Securely close the battery compartment cover by sliding it up until it snaps into place.

The DCT5280 series will only work with "AA" Ni-MH rechargeable batteries. If you use any other type of batteries, the display will show "Use rechargeable battery only".

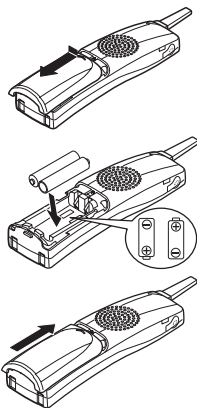

- Use only "AA" rechargeable Ni-MH batteries. Do Not use Alkaline, Lithium, or non-rechargeable batteries. To insure maximum performance and safety, use replacement batteries specifically matched for this phone, contact www.uniden.com. Using incorrect batteries could damage or limit the performance and could cause bodily injury.
- Recharge your phone on a regular basis by returning the handset to the cradle after each phone call.

Battery use time (per charge)

Fully charged (17-20 hours charge time)

- Up to 7 hours continuous use
- Up to 14 days when the handset is in the standby mode

Low battery alert

When the batteries are very low and need to be charged, the phone is programmed to eliminate functions in order to save power.

The batteries need to be charged when:

- The battery icon  appears.
- "Low Battery" appears in the display.

If the phone is in the standby mode, none of the keys will operate. If you are on a call, complete your conversation as quickly as possible, and return the handset to the cradle.

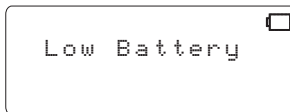

Cleaning the battery charging contacts

To maintain a good charge, it is important to clean the charging contacts on both the handset and the base unit once a month. Use a dry cloth or pencil eraser to clean. If the contacts become very dirty, using water only, dampen a cloth to clean the charging contacts. Then make sure to go back over the charging contacts with a dry cloth before returning the handset to the base to charge.

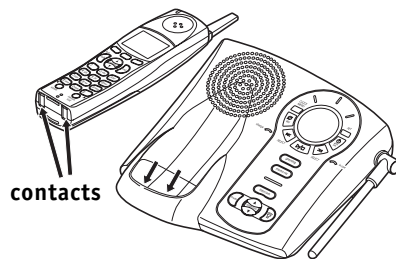

C. Connect the base unit

- 1) Install the desk top/wall mount adapter into the notches on the base top.
- 2) Connect the AC adapter to the **DC IN 9V** jack and to a standard 120V AC wall outlet.

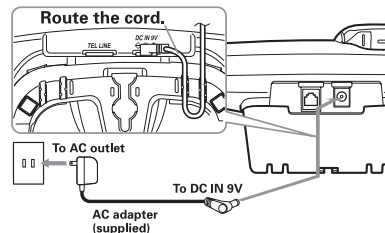
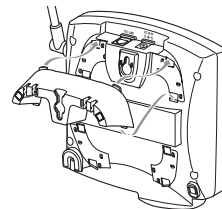

- 3) Set the base on a desk or tabletop, and place the handset in the base unit as shown.
- 4) Make sure the **charge** LED illuminates. If the LED does not illuminate, check to see that the AC adapter is plugged in and that the handset makes good contact with the base charging contacts.



- **Use only the supplied AD-830 AC adapter.**
Do not use any other AC adapter.
- Connect the AC adapter to a continuous power supply.
- Place the base unit close to the AC outlet so that you can unplug the AC adapter easily.
- While charging, all handset keys will be disabled.

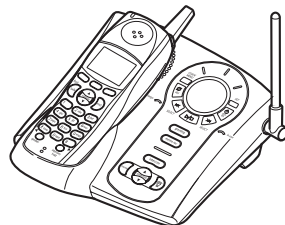

- After installing the batteries in the handset, charge your handset at least **17-20 hours before plugging into the phone line.**
- 5) Once the handset batteries are fully charged, connect the telephone line cord to the **TEL LINE** jack and to a telephone outlet.



If your telephone outlet isn't modular type, contact your telephone company for assistance.



Modular

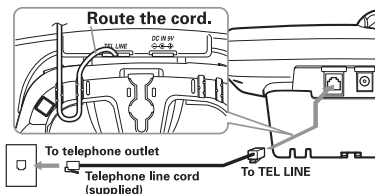

Place the power cord so that it does not create a trip hazard or where it could become chafed and create a fire or electrical hazard.

D. Choose the dialing mode

Most phone systems use tone dialing, which sends DTMF tones through the phone lines. However some phone systems still use pulse dialing such as in rural areas. The default setting is tone dialing. Depending on your dialing system, set the dial mode. To set the dial mode, see "Setting the Dial Mode" on page 30.



- If you are not sure of your dialing system, set the unit to tone dialing. Make a trial call. If the call connects, leave the setting as is, otherwise set the unit to pulse dialing.
- If your phone system requires pulse dialing and you need to send DTMF tones in certain situations during a call, you may "switch-over" to tone dialing. (Refer to "Tone Dialing Switch-over" on page 35.)



Do not use an outlet controlled by a wall switch.

Mounting the Base Unit on a Wall

Standard wall plate mounting

This phone can be mounted on any standard telephone wall plate.

- 1) Snap the desk top/wall mount adapter into the notches on the base bottom.
- 2) Plug the AC adapter to the **DC IN 9V** jack. Route the AC adapter cord inside the molded wiring channel as shown.
- 3) Plug the AC adapter into a standard 120V AC wall outlet.
- 4) Plug the telephone line cord into the **TEL LINE** jack. Route the cord inside the molded wiring channel as shown.
- 5) Plug the telephone line cord into the telephone outlet.
- 6) Raise the antenna to a vertical position.
- 7) Align the mounting slots on the base with the mounting posts on the wall. Push in and down until the base is firmly seated.

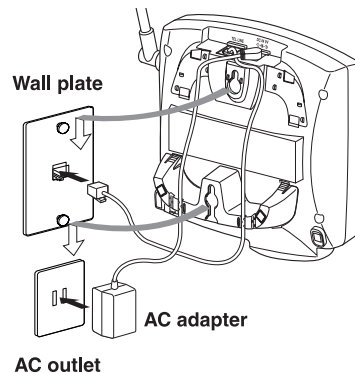
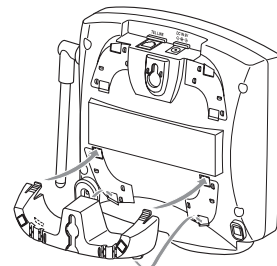

Direct wall plate mounting

If you don't have a standard wall plate, you can mount your base directly to the wall. Before doing this, consider the following:

- Avoid electrical cables, pipes, or other items behind the mounting location that could cause a hazard when inserting screws into the wall.
- Try to mount your phone within 10 - 15 feet of a working phone jack to avoid excessive cord lengths.
- Make sure the wall material is capable of supporting the weight of the base and handset.
- Use #10 screws (minimum length of 1-3/8 inches) with anchoring devices suitable for the wall material where the base unit will be placed.

- 1) Insert two mounting screws into the wall, (with their appropriate anchoring device), 3-15/16 inches apart. Allow about 1/8 of an inch between the wall and screwheads for mounting the base.
- 2) Refer to steps 1 through 7 on page 16 to mount the base.

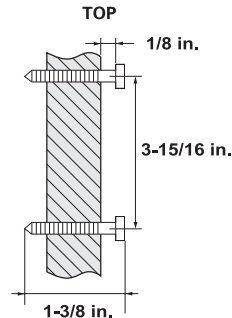

DCT5280 Flow Chart

• From the standby mode

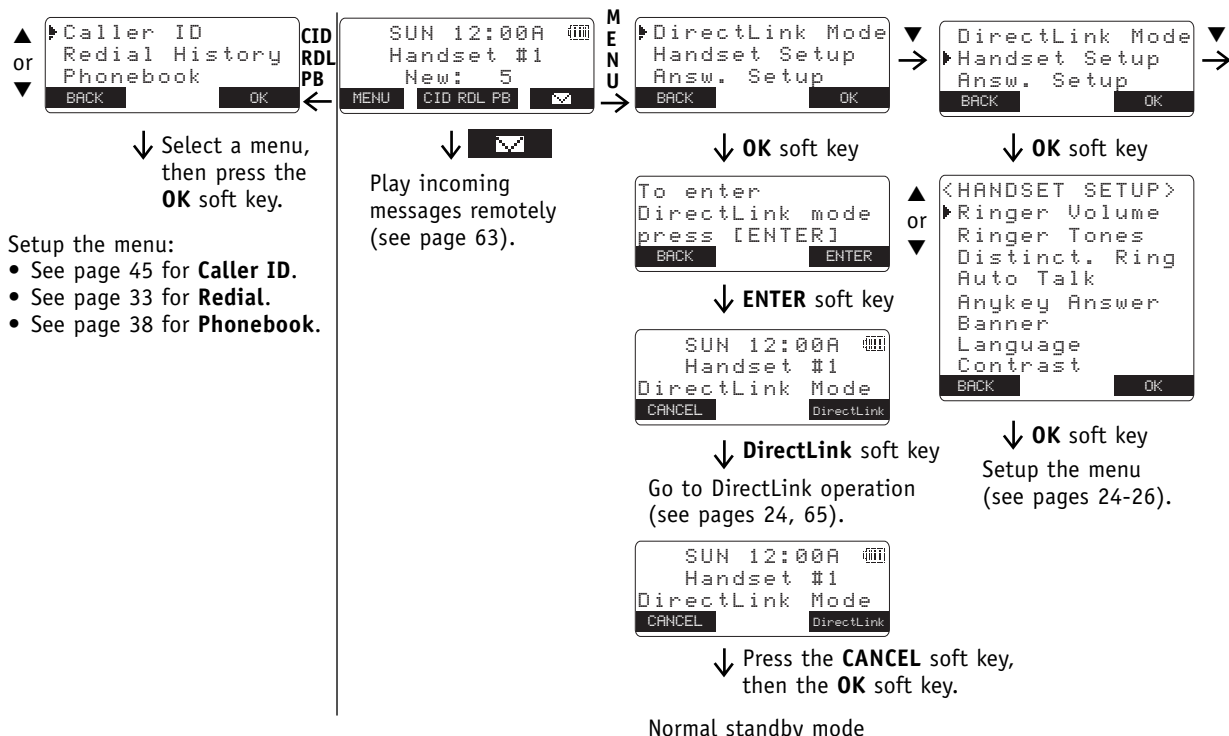

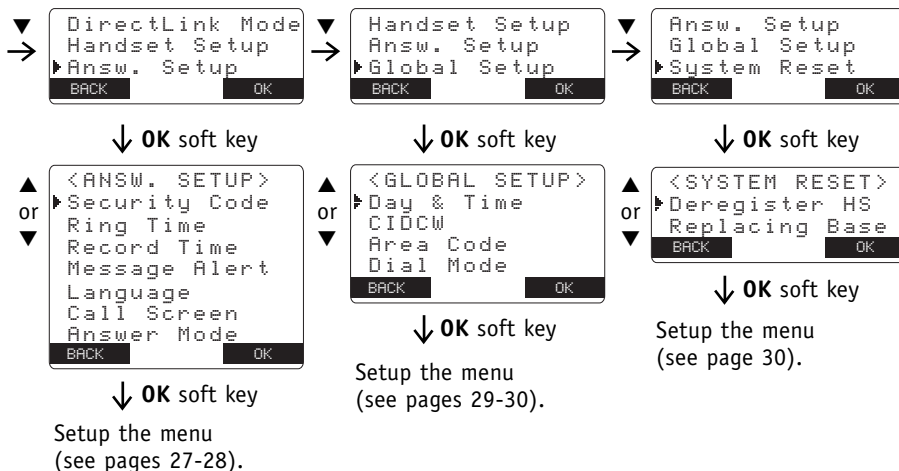

• From the Talk mode

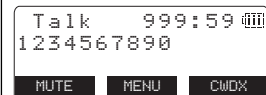

- Press the **MUTE** soft key to mute a call.
- Press the **MENU** soft key, then select:
 - "Booster On" to improve the sound quality (see page 35).
 - "Recording" to record the conversation (see page 60).
 - "Caller ID" to view Caller ID list (see page 46).
 - "Phonebook" to view phonebook locations (see page 42).
 - "Redial History" to view the last three number dialed (see page 33).
- Press the **CWDX** soft key to access the Call Waiting Deluxe Features (see page 49).



The **CWDX** soft key appears only when the Caller ID setup is set to "Cw On/CWDX On".



For Answ. Setup, Global Setup and System Reset (Deregister HS) menu, make sure the line is not in use, and the handsets are within the range limits of the base.

About the Menu

Most of the handset settings are set from the menu. The menu has 5 main menus (**DirectLink Mode, Handset Setup, Answ. Setup, Global Setup, and System Reset**) and submenus respectively.

Summary of the Main Menu and Submenu

DirectLink Mode

Select this menu to enter the handset into DirectLink mode. If you have 2 or more handsets, a pair of handsets work as transceivers. Use them at sporting events to stay in contact with family and friends, or at a shopping mall. To use this feature, you must set the two handsets to the DirectLink mode first (see page 24).



This menu only applies when you have 2 or more handsets.

Handset Setup

All settings must be set separately for each handset in the Handset Setup menu.

Submenu name	Description
Ringer Volume	Adjust the ringer volume (see page 24).
Ringer Tones	Adjusting the ringer tone (see page 25).
Distinct. Ring (Distinctive ring)	Set the distinctive ring (see page 25). "Distinctive Ringer" allows you to preset memory locations with a designated ring tone. When an incoming call is received and the Caller ID information matches the information in one of the memory locations, the distinctive ring that has been stored for that particular Caller will sound. If you have set multiple memory locations with distinctive rings, switching the setting to "Distinctive Off" will result in no distinctive ringing. All incoming calls will have a normal ring tone. Switching to "Distinctive On" will activate all programmed distinctive ring memory locations.

Submenu name	Description
AutoTalk	Allows you to answer the phone without pressing talk/flash or speaker . When the AutoTalk is set to On, simply remove the handset from the cradle and the phone automatically answers the call (see page 25).
Anykey Answer	Allows you to answer the phone without pressing talk/flash or speaker . When the Anykey Answer is On, you can answer a call by pressing any number key, X/ tone/◀ , or #/▶ on the handset (see page 26).
Banner	Customize the name of your handset, and display it in the LCD in the standby mode. For example, you can name the handset "John" (see page 26).
Language	Language option can be used to choose the language of your display. You can select from English, French, or Spanish (see page 26).
Contrast	Adjust the handset LCD brightness for better viewing (10 levels) (see page 26).

Answering Setup

This menu allows you to set up TAD settings from your handset. You can also set these setup menus from the base (see page 53).

Submenu name	Description
Security Code	Select a two-digit Personal Identification Number (PIN) code. A PIN code is required to play your messages from a remote location, you will need to enter a two-digit PIN code (see page 27).
Ring Time	Allows you to set the number of rings the caller hears before your answering system plays the outgoing message. You can set the ring time to answer after two, four, or six rings. Setting "TS" (Toll Saver), the answering system picks up after two rings if you have new messages, and after four rings if there are none (see page 27).
Record Time	Set the duration for recording the incoming messages. You have three record time options. The options "1 minute" or "4 minutes" set the duration for recording the incoming messages. "Announce only" answers the call with the preset greeting or your personal greeting but prevents the caller from leaving a message (see page 27)
Message Alert	Lets you know when you have a new incoming message by sounding a short alert tone (see page 28).

Submenu name	Description
Language	Select the Language of your answering system announcements from English, French, or Spanish (see page 28).
Call Screen	Set the call screening feature to On or Off (see page 28).
Answer Mode	Set your answering system to On or Off (see page 28).

Global Setup

If you change the setting in one of the handsets, you change the settings for all handset(s) in the Global Setup menu. Only one handset can change a setting at a time.

Submenu name	Description
Day & time	Set the day and time of your display (see page 29).
CIDCW	Set the Caller ID on Call Waiting (CIDCW) setting. CIDCW performs the same as regular Caller ID on call waiting number (see page 29). CW Deluxe allows you to handle call waiting calls in seven different ways (see page 49).
Area Code	Store or edit the area code. If you enter a 3-digit area code number in the "Area Code" option, your local area code does not appear in the Caller ID message. For calls received from outside your local area code, you will see a full 10-digit number (see page 29). Note: If your calling area requires 10-digit dialing, do not program this option.
Dial Mode	Set the dial mode to tone or pulse (see page 30).

System Reset

This menu is used to clear the handset ID from the base, or the base ID from the handset.

Submenu name	Description
Deregister HS	Clear the handset ID from the base. Use this menu, for example when you change the digital security code (see page 30).
Replacing Base	Clear the base ID. Use this menu, for example, if you replace the base with a different base of the DCT series model (DCT5260/DCT5280/DCT5285) (see page 30).

Setting up the Menu

Entering the Menu

- 1) Press the **MENU** soft key in the standby mode.
- 2) Press **volume/ ▲** or **▼** to move the pointer to a desired main menu (**DirectLink Mode, Handset Setup, Answ. Setup, Global Setup, and System Reset**).
- 3) Press the **OK** soft key to enter the menu. To return to the previous screen, press the **BACK** soft key.
- 4) Use **volume/ ▲** or **▼** to select a desired submenu, then press the **OK** soft key to enter.

In the submenu, **volume/ ▲** or **▼** is used to select an item. Press the **OK** soft key to confirm your setting. To return to the previous screen, press the **BACK** soft key. For detailed instructions, see the following sections for the desired submenu.

- 5) To exit the menu, press the **end** key.

- If any of the following occurs during the menu operation, the operation will be cancelled.
 - Press the **end** key.
 - Press **talk/flash** or **speaker**.
 - Charge the handset.
 - Receive an outside/intercom call.
- If the handset remains idle for 30 seconds, the phone will return to the standby mode.



For Answering Setup menu, you can also set them from the base (see page 53).



- If you select “Ringer Volume Off”,  icon appears in the display.
- If you press **volume/▲** in Ringer Volume High or **volume/▼** in Ringer Volume Off, you will hear a beep.

DirectLink Mode

Using the DirectLink Mode

- 1) Enter the “DirectLink Mode” menu (see “Entering the Menu” on page 23).
- 2) Press the **ENTER** soft key to enter the DirectLink mode. You will hear a confirmation tone, and “DirectLink Mode Complete” appears.
- 3) To return back to the normal mode, exit the DirectLink mode. To exit the DirectLink mode, press the **CANCEL** soft key, then the **OK** soft key, or return the handset to the cradle.

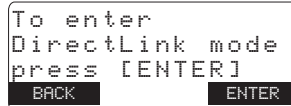

Handset Setup

Setting a Ringer Volume

- 1) Enter the “Handset Setup” menu, then the “Ringer Volume” submenu (see “Entering the Menu” on page 23).
- 2) Press **volume/▲** or **▼** to adjust the ringer settings (Ringer Volume Off, Ringer Volume Low, or Ringer Volume High). You will hear a ringer or melody at the selected volume (if you select “Ringer Volume Off”, no ringer or melody will sound).
- 3) Press the **OK** soft key. You will hear a confirmation tone.

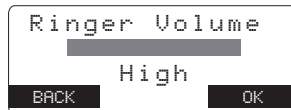

Selecting a Ringer Tone

- 1) Enter the "Handset Setup" menu, then the "Ringer Tones" submenu (see "Entering the Menu" on page 23).

You can choose from 8 ringers or 8 melodies:

- Ringers [Flicker, Clatter, Soft Alert, Wake Up, Light Bug, Beep Boop, Tone Board, Chip Chop]
- Melodies [Beethoven's Symphony #9 (Beethoven9), For Elise (Elise), We Wish You A Merry Christmas (Merry-Xmas), Home Sweet Home (Hm Swt Hm), Lorri Song #6 (Lorri Song), When The Irish Eyes Are Smiling (Irish Eyes), Aura Lee, Let Me Call You Sweet Heart (Sweetheart)]

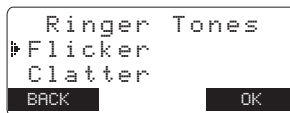

- 2) Press **volume/ ▲** or **▼** to move the pointer. You will hear the ringer or melody as you scroll through the options.
- 3) Press the **OK** soft key. You will hear a confirmation tone.

Distinctive Ringer Setup

- 1) Enter the "Handset Setup" menu, then the "Distinct. Ring" submenu (see "Entering the Menu" on page 23).
- 2) Press **volume/ ▲** or **▼** to select "On" or "Off".
- 3) Press the **OK** soft key. You will hear a confirmation tone.

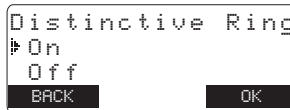

Setting the AutoTalk

- 1) Enter the "Handset Setup" menu, then the "Auto Talk" submenu (see "Entering the Menu" on page 23).
- 2) Press **volume/ ▲** or **▼** to change the selection, "On" or "Off".
- 3) Press the **OK** soft key. You will hear a confirmation tone.

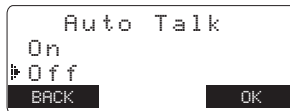

If you set the ringer to Off, the ringer tone will not sound.



If you don't enter a banner, the phone will use the handset ID for the banner (for example Handset #1).

Setting the Anykey Answer

- 1) Enter the "Handset Setup" menu, then the "Anykey Answer" submenu (see "Entering the Menu" on page 23).
- 2) Press **volume/ ▲** or **▼** to change the selection, "On" or "Off".
- 3) Press the **OK** soft key. You will hear a confirmation tone.

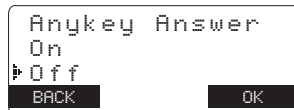

Setting the Banner

- 1) Enter the "Handset Setup" menu, then the "Banner" submenu (see "Entering the Menu" on page 23).
- 2) Use the number keypad (**0-9**), ***/tone/◀**, **#/▶**, or the **DELETE** soft key to enter or edit the name. To delete the current banner, press and hold the **DELETE** soft key, then enter the new name.
- 3) Press the **OK** soft key. You will hear a confirmation tone.

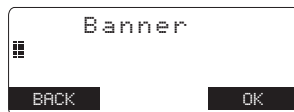

Selecting a Language

- 1) Enter the "Handset Setup" menu, then the "Language" submenu (see "Entering the Menu" on page 23).
- 2) Press **volume/ ▲** or **▼** to choose English, French (Français), or Spanish (Español).
- 3) Press the **OK** soft key. You will hear a confirmation tone.

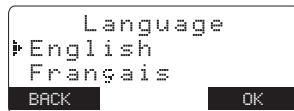

Adjusting the LCD Contrast

- 1) Enter the "Handset Setup" menu, then the "Contrast" submenu (see "Entering the Menu" on page 23).
- 2) Press **volume/ ▲** or **▼** to adjust the contrast of the LCD (10 levels).
- 3) Press the **OK** soft key. You will hear a confirmation tone.



If you press **volume/ ▲** in the highest contrast level or **volume/ ▼** in the lowest contrast level, you will hear a beep.

Answering System Setup

Setting a PIN Code

- 1) Enter the "Answ. Setup" menu, then the "Security Code" submenu (see "Entering the Menu" on page 23).
- 2) Enter a two-digit PIN code (01-99) using the number keypad (**0-9**).
- 3) Press the **OK** soft key. You will hear a confirmation tone.



Setting the Ring Time

- 1) Enter the "Answ. Setup" menu, then the "Ring Time" submenu (see "Entering the Menu" on page 23).
- 2) Press **volume/ ▲** or **▼** to select a Ring Time (Toll Saver, 2 Times, 4 Times, or 6 Times).
- 3) Press the **OK** soft key. You will hear a confirmation tone.

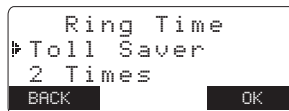

Setting the Record Time

- 1) Enter the "Answ. Setup" menu, then the "Record Time" submenu (see "Entering the Menu" on page 23).
- 2) Press **volume/ ▲** or **▼** to select Record Time (1 Minute, 4 Minutes, or Announce Only).
- 3) Press the **OK** soft key. You will hear a confirmation tone.

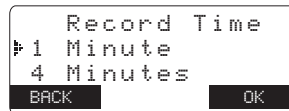

For Answering Setup menu, you can also set them from the base (see page 53).

Setting the Message Alert On or Off

- 1) Enter the "Answ. Setup" menu, then the "Message Alert" submenu (see "Entering the Menu" on page 23).
- 2) Press **volume/ ▲** or **▼** to choose "On" or "Off".
- 3) Press the **OK** soft key. You will hear a confirmation tone.



Setting the Language of your Answering System

- 1) Enter the "Answ. Setup" menu, then the "Language" submenu (see "Entering the Menu" on page 23).
- 2) Press **volume/ ▲** or **▼** to choose English, French (Français), or Spanish (Español).
- 3) Press the **OK** soft key. You will hear a confirmation tone.

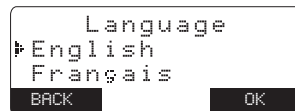

Setting the Call Screen

- 1) Enter the "Answ. Setup" menu, then the "Call Screen" submenu (see "Entering the Menu" on page 23).
- 2) Press **volume/ ▲** or **▼** to choose "On" or "Off".
- 3) Press the **OK** soft key. You will hear a confirmation tone.

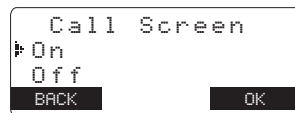

Setting the Answer Mode

- 1) Enter the "Answ. Setup" menu, then the "Answer Mode" submenu (see "Entering the Menu" on page 23).
- 2) Press **volume/ ▲** or **▼** to choose "On" or "Off".
- 3) Press the **OK** soft key. You will hear a confirmation tone.

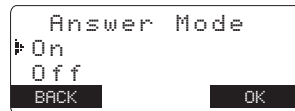

Global Setup

Setting Day and Time

- 1) Enter the "Global Setup" menu, then the "Day & Time" submenu (see "Entering the Menu" on page 23).
- 2) Press **volume/ ▲** or **▼** to select the day of the week, then press the **NEXT** soft key.
- 3) Press the number keypad (**0-9**) to set the time, then press the **NEXT** soft key.
- 4) Press **volume/ ▲** or **▼** to choose "AM" or "PM", then press the **OK** soft key. You will hear a confirmation tone.

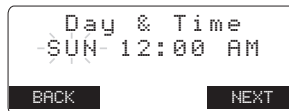

note

- You can set the clock either by the handset or base (see "Setting the time" on page 54).
- When a Global setting is changed from one handset, this affects all registered handsets.
- For setting the day and time, the idle time-out is extended to 2 minutes.

Setting CIDCW

- 1) Enter the "Global Setup" menu, then the "CIDCW" submenu (see "Entering the Menu" on page 23).
- 2) Press **volume/ ▲** or **▼** to select "CW On/CWDX On", "CW On/CWDX Off", or "CW Off/CWDX Off", then press the **OK** soft key. You will hear a confirmation tone.

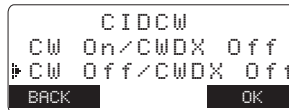

Setting the Area Code

- 1) Enter the "Global Setup" menu, then the "Area Code" submenu (see "Entering the Menu" on page 23).
- 2) Press the number keypad (**0-9**) to enter a 3-digit area code.
- 3) Press the **OK** soft key. You will hear a confirmation tone.



note

When the area code has already been stored in memory, the stored area code will be displayed. To change it, use the **DELETE** soft key and number keys to enter the new area code.

Setting the Dial Mode

- 1) Enter the "Global Setup" menu, then the "Dial Mode" submenu (see "Entering the Menu" on page 23).
- 2) Press **volume/ ▲** or **▼** to change the selection, "Tone" or "Pulse" (the initial setting is Tone).
- 3) Press the **OK** soft key. You will hear a confirmation tone.

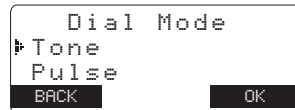

System Reset

De-register the Handset

- 1) Enter the "System Reset" menu, then "Deregister HS" submenu (see "Entering the Menu" on page 23).
- 2) Press **volume/ ▲** or **▼** to select the handset ID to be de-registered from the list, then press the **OK** soft key.
- 3) Press the **OK** soft key. You will hear a confirmation tone.
When de-registration is complete, "Deregistration Complete" appears.
- 4) After de-registering the handset, move to "Replacing the Base Setting" below.

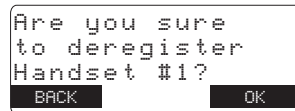
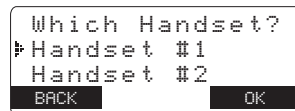

Replacing the Base Setting

- 1) Enter the "System Reset" menu, then "Replacing Base" submenu (see "Entering the Menu" on page 23). "Do you want to replace Base?" appears.
- 2) Press the **OK** soft key. You will hear a confirmation tone. The base information will be deleted.

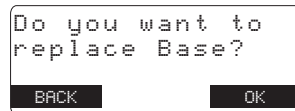

When replacing the base is complete, "Please Register" appears, register the handset(s) to the new base (see page 65).

Making and Receiving Calls

From the handset

On the handset, you may also use the speakerphone while talking to an outside call. Using the handset speakerphone is called “hands-free conversation”. This feature allows you to easily communicate while performing other tasks, such as cooking.  appears during hands-free conversations.



You can easily switch a call from normal conversation to “hands-free conversation”. To switch a call, press the **speaker** key during the call.

	Normal conversation	Hands-free conversation
To answer a call	Handset On the Cradle Pick up the handset (AutoTalk) or pick up the handset and press talk/flash . Handset Off the Cradle Press any number key, ✕ /tone/ ◀, or #/▶ (Any Key Answer), or press talk/flash .	Handset Off the Cradle Press speaker .
To make a call	Handset Off the Cradle 1) Press talk/flash . 2) Listen for the dial tone. 3) Dial the number. OR Dial the number, then press talk/flash .	Handset Off the Cradle 1) Press speaker . 2) Listen for the dial tone. 3) Dial the number. OR Dial the number, then press speaker .
To hang up	Press the end key, or return the handset to the cradle (AutoStandby).	
To enter a pause within the dialing sequence	When you dial the number in the standby mode, press the PAUSE soft key. “P” appears in the display, which represents a pause.	



- To set “Autotalk”, see page 25 or “Anykey Answer”, see page 26.
- The handset microphone is located at the bottom of the handset (see “Controls and Functions” on page 6). Position yourself as near to the handset as possible and speak clearly.
- If the line is in use by another handset(s), “Line In Use” appears in all registered handset’s display, that are not in use.

From the Base (Receiving calls only)

- 1) Press  (talk) and begin speaking.
- 2) To hang up, press  (talk).

 **note** The base microphone is located under the base (see "Controls and Functions" on page 7). Position yourself as near to the base as possible.

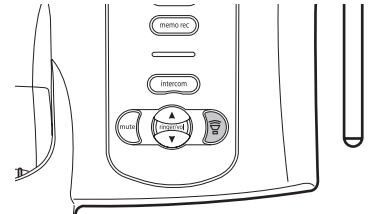

Placing a Call on Hold

- 1) During a call, press **intercom/hold**. The call will be put on hold.

 **note** Once 10 seconds has passed or when you press the **end** key, the call will be put on hold.

- 2) To talk to the caller, press **talk/flash** or **speaker** on a handset. The phone will return back to the call.

-  **note**
- You can hold a call for 5 minutes, when 5 minutes has passed, the call is disconnected and the phone returns to the standby mode.
 - While a call is on hold, CIDCW can not be received.

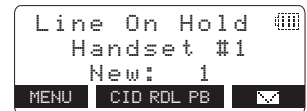
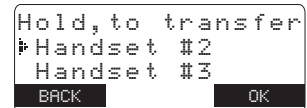

Redialing a Call

The last three phone numbers dialed can be quickly redialed.

Redialing from Standby Mode

- 1) Press the **CID RDL PB** soft key in the standby mode.
- 2) Press **volume/ ▲** or **▼** to select "Redial History", then press the **OK** soft key. The phone number that was last dialed appears in the display.
- 3) Press **volume/ ▲** or **▼** to toggle through the last three phone numbers dialed.
- 4) Press **talk/flash** or **speaker**. The selected number is dialed.
- 5) To hang up, press the **end** key.

Redialing from Talk Mode

- 1) Press **talk/flash** or **speaker**, then the **MENU** soft key.
- 2) Select the number you dialed by following steps 2-3 in "Redialing from Standby Mode". To go back, press the **BACK** soft key.
- 3) Press the **DIAL** soft key.
- 4) To hang up, press the **end** key.

Deleting a Redial Record

- 1) In the standby mode, recall the desired number by following steps 1-3 in "Redialing from Standby Mode".
- 2) Press the **DELETE** soft key.
- 3) Press **volume/ ▲** or **▼** to choose "Yes".
- 4) Press the **OK** soft key. The redialed number is deleted.

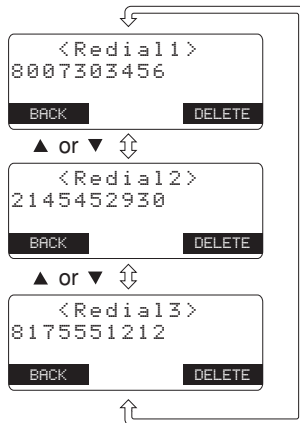

- If the number exceeds 32 digits, only the first 32 digits are retained in redial memory.
- If the redial memory is empty, you will hear a beep.
- If you have not pressed any key for 30 seconds, the phone returns to the standby mode.
- If you press the **end** key, the operation is canceled.



- To adjust the base ringer or speaker volume, see pages 52-53.

Ringer Mute (temporarily)

You can temporarily mute the handset and the base ringer tone. To mute the handset ringer tone, when the handset is off the cradle and the phone is ringing, press the **MUTE** soft key. To mute the base ringer tone, press \triangleright/\square on the base. The ringer tone will return to the previous setting starting with the next incoming call.

Adjusting the Earpiece and Handset Speaker Volume

You can select different volume levels for the handset earpiece and the handset speaker (6 levels: Low to Max). The volume can only be adjusted during a call. Press **volume/** \blacktriangle or \blacktriangledown to select the volume settings. When you hang up, the phone keeps the last volume setting selected.



If you press **volume/** \blacktriangle in the maximum volume level or **volume/** \blacktriangledown in the lowest volume level, you will hear a beep.

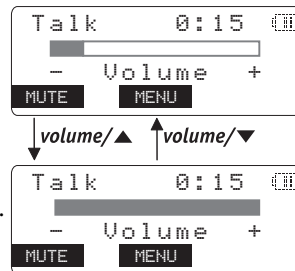

- If you press the **end** key to cancel muting, the call is disconnected and the phone will return to the standby mode.

Mute Microphone

With the handset

You can temporarily turn Off the microphone so that the person you are talking with cannot hear you.

During a telephone call press the **MUTE** soft key to turn Off the microphone. "Mute" and  appear in the display. Press the **MUTE OFF** soft key to cancel muting.

With the base

While using the base speaker phone, press **mute** on the base to turn Off the microphone. Press **mute** again or press  (talk) to cancel muting.

Tone Dialing Switch-over

Some telephone companies use equipment that requires pulse dialing (sometimes referred to as rotary dialing). If you need to enter tone dialing digits, you can switch-over to tone dialing during the call. For example, entering your bank account number after you have called your bank.

Initially make your call with the pulse dialing mode. Once your call connects, press *** /tone/ ◀**. Enter the desired number. These digits will be sent as tone dialing. Once the call ends, the tone mode is canceled and pulse dialing mode resumes.

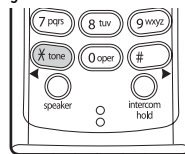

- The tone feature only applies when the dial mode is set to pulse.
- This special number can be stored in a memory location. This is referred to as Chain Dialing (see page 44).

Traveling Out-of-Range

During a call, as you begin to move your handset too far from your base unit, noise increases. If you pass the range limits of the base unit, you will hear a beep and "Out of Range" appears, then the handset returns to the standby mode. You may return back to the call if you move your handset within the range limits of the base, and press **talk/flash** or **speaker** within 30 seconds.

Clarity Booster

If you encounter interference while using your phone, you can manually improve the sound quality for clear operation. This works only when the phone is in use.

- 1) Press the **MENU** soft key.
- 2) Select "Booster On", then press the **OK** soft key. "Clarity Booster" appears in the display.

To turn Off the Clarity Booster, press the **MENU** soft key, select "Booster Off", then press the **OK** soft key again.

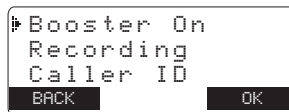



- Normally, the talk time is 7 hours, however, when the Clarity Booster is On, the talk time duration will be up to 5 hours with fully charged batteries.

3-Way Conferencing

The phone permits 3-way conversations between the handset, base, and an outside line.

When speaking on the handset

- 1) Press  (talk) on the base to initiate the 3-way conversation.
- 2) To hang up, press  (talk) on the base. The handset will still be connected to the call.

When speaking on the base

- 1) Press **talk/flash** or **speaker** on the handset to initiate the 3-way conversation.
- 2) To hang up, return the handset to the cradle, or press the **end** key on the handset. The base will still be connected to the call.

 If you purchase a DCX520 extra handset, the phone permits 4-way conversations, see “4-way Conferencing” on page 66 for details.

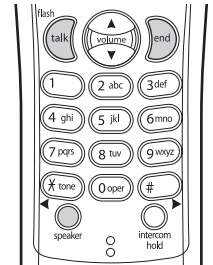
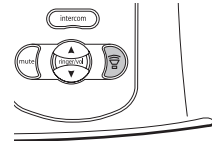

Intercom/ Call Transfer Feature

Intercom and transfer features are available for your phone. See “Intercom/Call Transfer Feature” on page 67 for details.

Flash and Call Waiting

If you have Call Waiting service and a call waiting tone sounds while you are on a call, press **talk/flash** to accept the waiting call. There is a short pause, then you will hear the new caller. To return to the original caller, press **talk/flash** again.

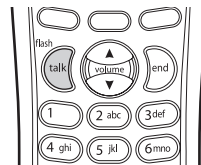

You must subscribe through your local telephone company to receive Call Waiting Service.

New Message LED

The **new message** LED on the handset is designed to work with your answering system. The LED flashes when you have new messages in your answering system.

The LED stops flashing when all new messages are played back (see “Using your Answering System” on page 58).



You have a total of 100 locations. However, Caller ID messages and Phonebook share the memory locations.

Phonebook

Phonebook allows you to dial a number using just a few key presses. Your phone stores names/numbers in the phonebook memory location, and you can search names in alphabetical order. You have a total of 100 locations that can be used for the phonebook (including the Speed dials) and Caller ID messages.



- If any of the following occurs during a phonebook operation, the operation will be canceled.
 - Press the **end** key. The phone will return to the standby mode (or the call will be disconnected).
 - Press **talk/flash** or **speaker**.
 - Receive an outside/intercom call.
 - Charge the handset
 - Receive a CIDCW (Caller ID on Call Waiting) (during a call or when the line is in use).
- If the handset remains idle for 30 seconds, the phone will return to the standby mode (or back to the call).

Storing Phone Numbers, Names, Distinctive Rings, and Speed Dial

- 1) When the phone is in the standby mode, press the **CID RDL PB** soft key.
- 2) Press **volume/ ▲** or **▼** to move pointer to "Phonebook", then press the **OK** soft key. The handset displays the following items:
 - (1st line) The number of the phonebook locations used
 - (2nd line) How to search (press the number keypad, **volume/ ▲** or **▼**)
 - (3rd line) How to enter the storing operation (press the **STORE** soft key)
 - (4th line) The **BACK** and the **STORE** soft keys.



3) Press the **STORE** soft key, "Store/Edit Name" appears.

4) Enter the name (up to 16 characters) by using the number keypad (see the "Steps for Entering Names and Special characters" on page 40).

If a name is not required, go to step 5. <No Name> will be used as the name.

5) Press the **OK** soft key to store the name, "Store/Edit No." appears.

6) Press the number keypad to enter the phone number (up to 20 digits), press the **OK** soft key to store the number.

7) "Distinctive Ring" appears. Press **volume/ ▲** or **▼** to move the pointer to one of the Distinctive Ring options, then press the **OK** soft key.



If you choose not to store a "Distinctive Ring", simply select the "No Selectn" option.

8) "Speed Dial" appears. Press **volume/ ▲** or **▼** to move the pointer to select the Speed dial location (10 locations: SPD1-SPD0).



If you choose not to store the name/number as a Speed Dial, simply select the "No Selectn" option.

9) Press the **OK** soft key. You will hear a confirmation tone and "Done!" appears in the display.

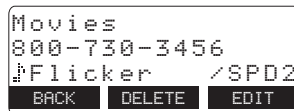
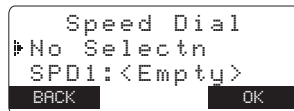
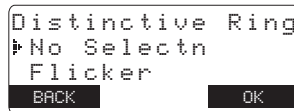

- When the memory is full, you will hear a beep and "Memory Full" appears. You cannot store names and numbers.
- The pause key counts as one digit. Pressing the **PAUSE** soft key more than once increases the length of the pause between numbers. Each pause represents a 2 second delay.
- Selecting a speed dial location where a number is already stored, releases the old number's speed dial setting. The new number will be stored in the speed dial location.

Steps for Entering Names and Special Characters

Refer to the letters on the number keys to select the desired characters. With each press of a number key (0-9), the displayed character appears in the following order: Upper case letters first, lower case letters next and finally the number corresponding to the key.

	Number of times key is pressed								
keys	1	2	3	4	5	6	7	8	9
1	1								
2 abc	A	B	C	a	b	c	2		
3 def	D	E	F	d	e	f	3		
4 ghi	G	H	I	g	h	i	4		
5 jkl	J	K	L	j	k	l	5		
6 mno	M	N	O	m	n	o	6		
7 pqrs	P	Q	R	S	P	q	r	s	7
8 tuv	T	U	V	t	u	v	8		
9 wxyz	W	X	Y	Z	w	x	y	z	9
0 oper	&	<	>	<	>	/	(blank)	-	_
	.	,	:	?	!	@	'	"	*
	#	0							

If you make a mistake while entering a name

Use ***/tone/◀** or ***/▶** to move the cursor to the incorrect character. Press the **DELETE** soft key to erase the wrong character, then enter the correct character. To delete all characters, press and hold the **DELETE** soft key.

For example, to enter **Movies**:

- 1) When the phone is in the standby mode, recall the "Phonebook" menu by following steps 1-2 in "Storing Phone Numbers, Names, Distinctive Rings, and Speed Dial" on page 38.
- 2) Press the **STORE** soft key, "Store/Edit Name" appears.
- 3) Press **6** once, then press ***/▶** to move the cursor to right.
- 4) Press **6** six times.
- 5) Press **8** six times.
- 6) Press **4** six times.
- 7) Press **3** five times.
- 8) Press **7** eight times.
- 9) When finished, press the **OK** soft key.

To continue to store the telephone number, proceed to step 6 on page 39.



If the next character uses the same number key, you must press ***/▶** to move the cursor over. Otherwise the next time you press the number key, it changes the character that was previously set.



- “/SPDn” appears when you view a speed dial.

- During a call, don't press the **end** key or the call will be disconnected.

Viewing the Phonebook

Your phone stores names/numbers in the phonebook memory locations, and you can search names in alphabetical order. You can view the phonebook even while the phone is in use.

- 1) Press the **CID RDL PB** soft key (or the **MENU** soft key during a call).
- 2) Press **volume/ ▲** or **▼** to move the pointer to “Phonebook”, then press the **OK** soft key.

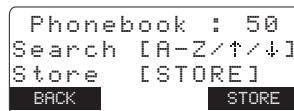

If you recall the phonebook during a call, the following screen appears.



- 3) Press **volume/ ▲** or **▼**, or the number keypad to scroll through the phonebook locations. Phonebook locations appear in alphabetical order (from first to last when you press **volume/ ▼**, from last to first when you press **volume/ ▲**). Or, refer to the letters on the number keys to select the first letter of the desired name. Press a number key (**2-9** and **0**) once for the first letter, press twice for the second letter, and so on. The first location that begins with the letter you entered appears.
For example, to search for “Movies”, press **6** once. Press **volume/ ▲** or **▼** until the phonebook location is displayed.
- 4) To finish the viewing operation, press the **BACK** soft key repeatedly or the **end** key.

Making Calls Using the Phonebook

From Standby Mode

- 1) When the phone is in the standby mode, view the phonebook location to dial (see "Viewing the Phonebook" on page 42).
- 2) Press **talk/flash** or **speaker**. The displayed number is dialed.
- 3) To hang up press the **end** key.



From Talk Mode

- 1) Press **talk/flash** or **speaker**.
- 2) View the phonebook location to dial (see "Viewing the Phonebook" on page 42).
- 3) Press the **DIAL** soft key. The number in the displayed phonebook location is dialed.
- 4) To hang up press the **end** key.

Speed Dialing

If you store a phone number in a speed dial memory location (10 locations: SPD1 - SPD0), you can use the speed dialing feature. When the phone is in the standby mode, press and hold a number key (0-9) associated with the speed dial until the phone number appears, then press **talk/flash** or **speaker**. The number stored in the speed dial (SPD1 - SPD0) is dialed.

Editing or Erasing a Stored Name, Phone Number, Distinctive Ring, and Speed Dial

- 1) When the phone is in the standby mode, press the **CID RDL PB** soft key.
- 2) Press **volume/ ▲** or **▼** to move the pointer to "Phonebook", then press the **OK** soft key.

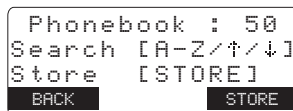

- 3) Press **volume/ ▲** or **▼**, or the number keypad to view the phonebook locations (see “Viewing the Phonebook” on page 42).

a. Editing the Stored Data

- 1) When the phonebook location to be edited appears, press the **EDIT** soft key. “Store/Edit Name” appears.
- 2) Follow the steps 4 to 8 under “Storing Phone Numbers, Names, Distinctive Rings, and Speed Dial” on page 39 to complete the editing operation.
- 3) Press the **OK** soft key. You will hear a confirmation tone.



b. Deleting the Stored Data

- 1) When the phonebook location to be deleted appears, press the **DELETE** soft key. “Delete Memory?” appears.
- 2) Press **volume/ ▲** to move the pointer to “Yes”.
- 3) Press the **OK** soft key. You hear a confirmation tone. “Deleted!” appears in the display.

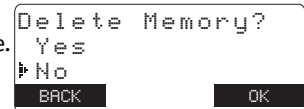

Chain Dialing

The memory locations in the handset are not limited to phone numbers. You can also store a group of numbers (up to 20 digits), that you need to enter once your call connects. This is referred to as Chain Dialing.

An example of this is a bank account number. Store a special number in the phonebook location (refer to “Storing Phone Numbers, Names, Distinctive Rings and Speed Dial” on page 38). Once you have called your bank, and when you are prompted to enter the account number, just as you do when viewing the phonebook location, view the special number, then press the **DIAL** soft key.

Caller ID

You must subscribe to Caller ID service to use this feature.

When the telephone rings, the Caller ID feature allows you to view the caller's name and phone number in the display before you answer the phone. Additionally, you can dial the displayed number and store the information for memory dialing. Make sure you have turned On the CIDCW feature (see page 29).

Important:

Memory locations for Caller ID messages and Phonebook locations (including Speed Dials) are common, you can store up to 100 in total. A Caller ID message is not stored when you have stored 100 of the phonebook locations. The earliest Caller ID message is overwritten when you have stored 100 of the phonebook locations and Caller ID messages in total.

- If any of the following occurs during Caller ID operation, the operation will be canceled.
 - Press the **end** key. The phone will return to the standby mode (or the call will be disconnected).
 - Press **talk/flash** or **speaker**.
 - Receive an outside/intercom call.
 - Receive a CIDCW (Caller ID on Call Waiting) (during a call or when the line is in use).
 - Charge the handset.
- If the handset remains idle for 30 seconds, the phone will return to the standby mode (or back to the call).

- 1) When the Caller ID message is received, the display shows the caller's phone number along with the date and time. The incoming call information is stored in the Caller ID record. If the Caller ID service includes the caller's name, the name will appear in the display (up to 15 characters).

The date and time received _____
Caller's name _____
Caller's phone number _____
Soft keys _____

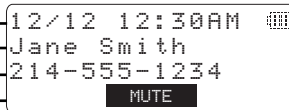

note

- If you answer a call before the Caller ID message is received (Example: before the second ring), the Caller ID message will not appear.
- When the call is received via a telephone company that does not offer Caller ID service, the caller's phone number and name does not appear. (This includes some international calls.)
- When the call is via a private branch exchange (PBX), the caller's phone number and name may not appear.



- The number of calls from the same Caller ID appears next to the received time. Once you have reviewed the new message, the number will be cleared and disappears.
- During a call, don't press the **end** key or the call will be disconnected.

You may receive any one of the following messages:

When invalid data is received	"Incomplete Data"
When a private name is received	"Private Name"
When a private number is received	"Private Number"
When an unknown name is received	"Unknown Name"
When an unknown number is received	"Unknown Number"

- 2) When you receive the call, the display changes to "Talk".

Viewing the Caller ID List

The Caller ID list stores information for incoming calls – even unanswered calls.

You can store 100 of the Caller ID messages and Phonebook locations (including Speed Dials) in total. You can view the Caller ID list during a call or when the phone is in the standby mode.

- 1) Press the **CID RDL PB** soft key in the standby mode (or the **MENU** soft key during a call).
- 2) Press **volume/ ▲** or **▼** to move the pointer to "Caller ID", then press the **OK** soft key. The screen shows the number of new messages and the total number of messages.
- 3) To view the Caller ID messages in historical order (from new to old or from old to new), repeatedly press **volume/ ▼** to scroll through the messages from the latest to the earliest, or **volume/ ▲** to scroll back through the messages.
Or, to view the Caller ID messages with alphabetical search, press the number key pad (**2-9** and **0**) with the letter associated with the first letter of the desired message.



- Once you view the Caller ID list with alphabetical search, you cannot switch back to historical order (from new to old or from old to new) unless you exit and re-enter the operation.
- 4) To finish the viewing operation, press the **BACK** soft key repeatedly or the **end** key.

Deleting Information from the Caller ID List

Deleting a Caller ID message

- 1) When the phone is in the standby mode, view the Caller ID information to be deleted (see "viewing the Caller ID List" on page 46).
- 2) Press the **DELETE** soft key.
"Delete Caller ID" appears.
- 3) Press **volume/ ▲** or **▼** to choose "Yes".
- 4) Press the **OK** soft key. You will hear a confirmation tone.

```

Delete Caller ID
▶ Yes
  No
  BACK      OK
  
```

Deleting all Caller ID names/numbers

- 1) When the phone is in the standby mode, press the **CID RDL PB** soft key.
- 2) Press **volume/ ▲** or **▼** to move the pointer to "Caller ID", then press the **OK** soft key. The number of new and total records appear.
- 3) Press the **DELETE** soft key.
- 4) Press **volume/ ▲** or **▼** to choose "Yes".
- 5) Press the **OK** soft key. You will hear a confirmation tone.

```

Caller ID
New : 5
Total: 25
  BACK      DELETE
  
```

```

Delete All?
▶ Yes
  No
  BACK      OK
  
```

note

Once the Caller ID data has been deleted, the information cannot be retrieved.



- You cannot make a call from the Caller ID list if your phone is connected to a private branch exchange (PBX).
- When a long distance call has been set, “1” appears in the display.
- If a call comes in via a telephone system that does not offer Caller ID service, no information is stored.
- If the Caller ID message was received as a private/unknown number, or the message does not have the number, you cannot store the message in the Phonebook. Or it was received as private/unknown name, the message will be stored as <No Name>.
- Even if the 100 memory locations are full, the message will be stored in the Phonebook. However, the message will be erased from the Caller ID list.

Using the Caller ID Message List

Calling a party from the Caller ID list

From Standby mode

- 1) When the phone is in the standby mode, view the Caller ID message (see “Viewing the Caller ID List” on page 46).
- 2) Press **talk/flash** or **speaker**. The displayed phone number dials automatically.

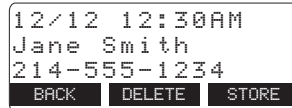

From Talk mode

- 1) Press **talk/flash** or **speaker**.
- 2) View the Caller ID message you want to dial (see “Viewing the Caller ID list” on page 46).
- 3) Press the **DIAL** soft key. The displayed phone number will be dialed.

Long Distance calls and Area Code Setting/Cancellation

While the present Caller ID information is displayed, pressing ***/tone/◀** will place or remove the prefix “1” in the display to set the call for a long distance call, or pressing **#/▶** will set or cancel an area code (see page 29).

Storing Caller ID messages in the Phonebook

Messages shown in the Caller ID list can be stored in the phonebook. The phone number and name of the party on the Caller ID list can be stored in memory.

- 1) When the phone is in the standby mode, view the Caller ID message to be stored. Then press the **STORE** soft key. “Store/Edit Name” appears.
- 2) To complete the setting, follow the steps 5-9 in “Storing Phone Numbers, Names, Distinctive Rings, and Speed dial” on page 39.

Call Waiting Deluxe Features

Your phone gives you new options for call waiting. At the touch of a button, you can place the caller on hold, send them to your voice mail service, or conference them into your current call. You may be required to subscribe to Call Waiting and Call Waiting Deluxe to use these features. Not all features are available in all areas. Check with your local telephone company for details.

- 1) When you receive a Call Waiting call, press the **CWDX** soft key for a list of options.
- 2) Press **volume/ ▲** or **▼**, or the number keypad (**1-7**) to select an option.

For example:

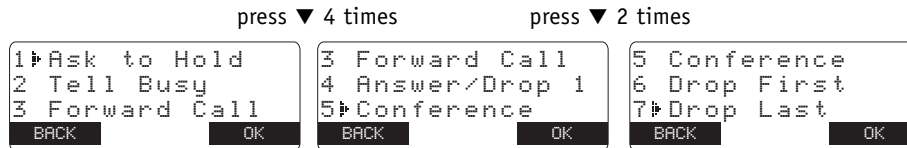

- 3) Press the **OK** soft key. A confirmation screen will appear, and returns back to the call.

Your phone is pre-programmed with seven call waiting options. You may select to ask the calling party to hold, send them a busy message, forward them to your voice mail, or answer and drop the first caller. You may also select to conference them into the current call or, at any time, choose to drop the first or drop the last caller. Check with your local telephone company for a full list of options.



- To activate features and display the **CWDX** soft key, select "CW On/CWDX On" in the Caller ID setup. See page 29.
- You can also answer a waiting call immediately by pressing **talk/flash**, the first caller will be placed on hold. To return to the original caller, press **talk/flash** again.
- To return back to a call, press the **BACK** soft key.

The Integrated Answering Device

The phone has a built-in answering system that answers and records incoming calls. You can also use your answering system to record a conversation, leave a voice memo message, or to announce a special outgoing message to callers when you're away from your phone.

Features

- Digital Tapeless Recording
- Call Screening On/Off
- Voice Prompts for Menu Setup Guidance
- Remote Message Retrieval
- Conversation Recording
- Trilingual Language Option
- Remote Operation from the Handset
- Approx. 12 Minutes of Recording Time
- Selectable Outgoing Messages
- Time and Day Announcement
- Toll Saver
- Voice Memo
- Message Alert

Digital Tapeless Recording allows you to quickly review, save, or delete the messages you choose. You will never have to worry about a tape wearing out, jamming, or resetting improperly.

The Integrated Answering System is easy and convenient to use, but **please read** through all of the instructions carefully.

Turning the Answering System On/Off

- 1) To turn the answering system On, press **⓪ ans on** in the standby mode. After the announcement "Answering System is on", the current greeting message will be played and you will hear a confirmation tone. The message counter displays the number of messages stored in memory. If the display flashes, then there are new messages waiting for you.
- 2) To turn the answering system Off, press **⓪ ans on**. After the announcement "Answering System is off", the message counter display will no longer be illuminated.

You can also turn the Answering System On or Off from the handset using the menu mode (see page 28).

Setting up your Answering System

Setting your outgoing message (Greeting)

When you receive a call, the answering system automatically plays either the pre-recorded message or your own greeting.

Pre-recorded message

The following message is pre-recorded:

"Hello, no one is available to take your call. Please leave a message after the tone."

Recording a personal outgoing message (Greeting)

You can record a greeting up to 30 seconds long (must be more than 2 seconds long).

- 1) When the phone is in the standby mode, press and hold **greeting**.
- 2) Start your recording after the announcement "Record greeting". The message counter displays "30", then begins to count down.
- 3) When you have finished recording your greeting, press **greeting**, **▷/□** or **set**. You will hear a confirmation tone and your recorded greeting plays back for you.



- When the answering system is full, "FL" appears on the base. You should delete some messages so that the system can record new messages.
- Position yourself as near to the base as possible and speak clearly when recording your outgoing message.
- If you make an outside call, or a call is received on the base during the operation, the operation is canceled.



- If an outside call is received during the operation, the operation is canceled.
- If you press **ringer/vol ▲** in the maximum volume level (3) or **ringer/vol ▼** in the ringer off (0), you will hear a beep.

Choosing between the two outgoing messages

When the phone is in the standby mode, press **greeting**. Press **greeting** again when the outgoing message is played. Each time **greeting** is pressed, the outgoing message is switched between the pre-recorded and the personal outgoing message.

Deleting an outgoing message

To delete the personal outgoing message, press **∅ del** while the message is playing. The system announces "Greeting has been deleted".

Setting the base ringer volume

You have four ringer volume options. One allows you to turn the base ringer off. The other three are volume levels.

- 1) When the phone is in the standby mode, press **ringer/vol ▲** or **▼**. You hear the ringer at the current volume level ("3" High, "2" Medium, "1" Low, or "0" Off) (if you set the base ringer volume to off "Ringer Off" is announced), and it appears on the base.
- 2) Press **ringer/vol ▲** or **▼** repeatedly until the desired ringer volume appears. You will hear a ringer at the selected volume level. The system returns to the standby mode.

You can also set the base ringer volume or while the phone is ringing, press **ringer/vol ▲** or **▼** repeatedly to select the desired ringer volume.

Adjusting the speaker volume level

When the base speaker is in use, press *ringer/vol* ▲ or ▼ on the base to adjust the volume. Press *ringer/vol* ▲ for louder or *ringer/vol* ▼ for softer.

The numbers 1-10 appear on the base indicating the volume levels. 1 being the softest and 10 being the loudest.

Using the menu mode

The Menu mode allows you to set the following Answering System functions.

- To scroll through the menu options, repeatedly press **CLOCK/MENU** on the base in the standby mode. The system returns to standby after the last menu option. A confirmation tone sounds to indicate the standby mode.
- If you press ▷/◻, the operation is canceled.
- If the system remains idle for about 5 seconds after the announcement, the system returns to standby. Once >> /SELECT or << /SELECT is pressed, the idle time is extended to 10 seconds.
- If there is an incoming call, the operation is canceled.
- When you have completed the setting, press ▷/◻ to exit the menu mode, or **CLOCK/MENU** to move to the next menu option.
- You can also set these menus from the handset. See "Answering System Setup" on page 27 for instructions.



For your convenience, voice prompts will guide you through the menu setup mode.

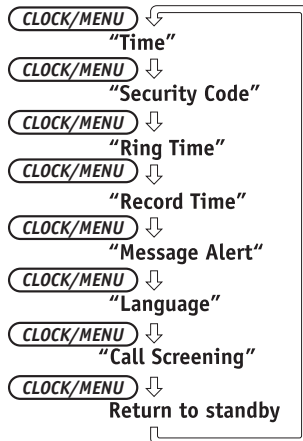

- If you press *ringer/vol* ▲ in the maximum volume level (10) or *ringer/vol* ▼ in the lowest volume level (1), you will hear a beep.
- Press and hold *ringer/vol* ▲ or ▼ on the base to scroll quickly through the volume levels.



- Normally, if the system remains idle for 10 seconds after **>> /SELECT** or **<< /SELECT** is pressed, the system will return to standby. However, for setting the time, the idle time is extended to two minutes.
- Press and hold **>> /SELECT** or **<< /SELECT** to quickly scroll through the numbers on the display.
- Time stamp will not be heard until you have set the time.

Setting the Time

Follow these steps to set the clock on the answering system to the correct time.

- 1) Press **CLOCK/MENU**.
- 2) Press **>> /SELECT** or **<< /SELECT** until the correct day is announced and the corresponding number (from "1" Sunday to "7" Saturday) appears.
- 3) Press **SET** to select the day.
- 4) Press **>> /SELECT** or **<< /SELECT** until you hear the correct hour setting. The numbers "1" through "12" appear on the base as each hour is announced.
- 5) Press **SET** to select the hour.
- 6) Press **>> /SELECT** or **<< /SELECT** until you hear the correct minute setting. The numbers "00" through "59" appears on the base as each minute is announced.
- 7) Press **SET** to select the minute.
- 8) Press **>> /SELECT** or **<< /SELECT** until you hear the correct AM or PM setting. The message counter displays "A" or "P".
- 9) Press **SET** to select the AM/PM setting. A confirmation tone sounds, the day and time you set are announced for your review.

Setting a PIN code

To play your messages from a remote location, you will need to enter a two-digit Personal Identification Number (PIN) code (01-99). To select a PIN code, perform the following steps:

- 1) Press **CLOCK/MENU** twice. The current PIN code appears on the base and it is announced.
- 2) Press **>> /SELECT** or **<< /SELECT** until the desired number appears. Press and hold **>> /SELECT** or **<< /SELECT** to quickly scroll through the numbers on the display.
- 3) Press **SET** to select the PIN code. A confirmation tone sounds, the system announces the new PIN code.

Setting the ring time

The ring time setting allows you to set the number of rings the caller hears before your answering system plays the outgoing message. You can set the ring time to answer after two, four, or six rings. Setting "TS" (Toll Saver), the answering system picks up after two rings if you have new messages, and after four rings if there are none. This way, if you make a long distance call to check your messages, you can hang up after the second ring to avoid billing charges.

- 1) Press **CLOCK/MENU** three times.

The current ring time setting ("2" 2, "4" 4, "6" 6, "TS" Toll saver) appears on the base and it is announced.

- 2) Press **>> /SELECT** or **<< /SELECT** until the desired ring time appears.
- 3) Press **SET** to select the new ring time.

A confirmation tone sounds, the system announces the new ring time.

Selecting the message record time

You have three record time options. The options "1 minute" or "4 minutes" set the duration for recording the incoming messages. "Announce only" answers the call with the preset greeting or your personal greeting but prevents the caller from leaving a message.

- 1) Press **CLOCK/MENU** four times.

The current recording time ("1" 1 minute, "4" 4 minutes, "R" Announce only) appears on the base and it is announced.

- 2) Press **>> /SELECT** or **<< /SELECT** until the desired message record time appears.
- 3) Press **SET** to select the new recording time.

A confirmation tone sounds, the system announces the new record time.



When using the Announce only feature, you may want to change your outgoing message, if the message prompts the caller to leave a message. The pre-recorded message changes automatically.

Announce only feature

The Announce only feature plays a pre-recorded outgoing message or your own personal outgoing message, but it will not allow the caller to leave a message. To set “Announce only”, follow the steps on page 55. To choose between the pre-recorded message or your own personal greeting, press ***greeting***, when the outgoing message is played. Press ***greeting*** to select the greeting of your choice.

A confirmation tone sounds. If you want to use your own greeting, you may want to change your greeting to omit the prompt to leave a message. Refer to “Recording a personal outgoing message (Greeting)” on page 51.

The following message is pre-recorded:

“Hello, no one is available to take your call. Please call again.”

Setting the message alert

Message Alert feature lets you know when you have a new incoming message by sounding a short alert tone.

If you set the Message Alert On, and when a new message is received, the alert tone will sound every 15 seconds. Set the Message Alert to On or Off by using the **CLOCK/MENU** key.

- 1) Press **CLOCK/MENU** five times. The current setting (On or Off) appears on the base and it is announced.
- 2) Press **>> /SELECT** or **<< /SELECT** to choose “On” or “Off”.
- 3) Press **SET**.

A confirmation tone sounds, the system announces the current setting you have selected.

When the first new message is received, the alert tone will begin to sound.

Turning the message alert tone Off by pressing any key

To quickly turn Message Alert Off, press any key on the base unit and the tone will automatically deactivate.

Turning the message alert tone Off when you are away from your phone

When all new messages are played back using the remote playback feature (see pages 61-63) the Message Alert will automatically deactivate. The tone will not deactivate until all new messages are played back.

Selecting the language

You can select the Language of your answering system announcements to English, French, or Spanish.

- 1) Press **CLOCK/MENU** six times.

The current setting ("E" English, "F" French, or "S" Spanish) appears on the base, and it is announced ("English" English, "Français" French, or "Español" Spanish).

- 2) Press **>> /SELECT** or **<< /SELECT** to select the language.
- 3) Press **SET**.

A confirmation tone sounds, the system announces the new setting in the selected language.

Setting the call screen

You can screen calls when the Call Screen function is set to On.

- 1) Press **CLOCK/MENU** seven times.

The current Call Screen setting (On or Off) appears on the base.

- 2) Press **>> /SELECT** or **<< /SELECT** to choose "On" or "Off".
- 3) Press **SET**. A confirmation tone sounds, and the system announces the new setting.

You can mute the Call Screen temporarily. When the system is answering, press **▷/□**.

The Call Screen function resumes when the system is no longer in answering mode.

Additionally, to adjust the volume, press **ringer/vol ▲** or **▼**.



If you set the answering system to Off, you cannot screen a call.

Screening a call

To screen an incoming call, do the steps as follows:

- 1) After the answering system answers, the base speaker will let you hear the calls as the machine records the message.
- 2) To answer the call, press **☎** (talk) or pick up the handset from the base (when AutoTalk is set to On). If the handset is away from the base, press **talk/flash, speaker** or any number key, ***/tone**, or **#** (when AutoTalk is set to On). The answering system will disconnect automatically.



- If an outside call is received during the operation, the operation is canceled.

- To stop playing your messages, press \triangleright/\square again at any time.
- When the answering system is full, "FL" appears on the base. You should delete some messages so that the system can record new messages. (Refer to "Deleting a message" on page 59.)

Using your Answering System

The message counter displays the number of messages stored in memory. If the display flashes, then there are new messages waiting for you. The answering system is designed to play your new messages first. After you play all your new messages, you can then play your old messages.

Playing your messages

- 1) When the phone is in the standby mode, press \triangleright/\square .
The system announces the number of new and old messages while the message counter displays only the number of new messages. The time and day that each message was received is announced after the message is played. The message counter will then display the number of current stored messages.
- 2) When all new messages have been played, you hear a confirmation tone and the system announces "End of message". The system returns to standby. After you have reviewed your new messages, you can play your old messages by again pressing \triangleright/\square .
Once you have listened to a new message, it then becomes an old message. The old messages will be played in the order in which they were received.

Repeating a message

- 1) Press \triangleright/\square to review your messages. The number of stored messages is announced.
- 2) To repeat the current message, press $\ll /SELECT$ after a few seconds of beginning the message. To quickly scroll backwards through a message, press and hold $\ll /SELECT$.
To repeat the previous message, press $\ll /SELECT$ within a few seconds (about 4 seconds during remote operation) after a message begins playing. If you have several messages, press $\ll /SELECT$ repeatedly until you return to the message you want to replay. If the current message is the first new message, the system plays back from the beginning of the current message (it does not go back into the old message group).
- 3) Press \triangleright/\square at any time to stop reviewing messages and return to standby.
The message counter shows the number of messages stored in memory.

Skipping a message

- 1) Press ▸/□ to review your messages. The number of stored messages is announced.
- 2) Press >> /**SELECT** at anytime to skip to the next message.
Each time >> /**SELECT** is pressed, the system scans forward one message. If you have several messages, press >> /**SELECT** repeatedly to find the message you want to play. To quickly scroll through a message, press and hold >> /**SELECT**. The system advances through the playback at double speed.
- 3) Press ▸/□ at anytime to stop reviewing your messages and return to standby.
The message counter shows the number of messages stored in memory.

Deleting a message

To maintain maximum record time, delete the old messages.

- 1) Press ▸/□ to review your messages.
- 2) Press ∅ **del** at anytime during the message to delete the message.
You hear a confirmation tone and the message is deleted.
- 3) To delete all messages, press ∅ **del** in the standby mode. Press ∅ **del** again after the announcement "To delete all message, press delete again."

When you try to delete all messages without first listening to your new messages, you hear several short beeps followed by an announcement "Please playback all messages". This protects you from accidentally erasing messages you have not yet reviewed.

Important:

When you press ∅ **del**, you are permanently deleting the message. Once deleted, the message cannot be replayed or retrieved.



Every state has different regulations governing the recording of conversations over the telephone. Make sure to check your local, state and federal laws before using this product to record any telephone conversation in order to determine that your use is in compliance with such laws or guidelines.

Voice memo

The voice memo function allows the user to record messages (more than 2 seconds and within 4 minutes).

- 1) Press and hold **memo rec**. You hear a beep.
- 2) Start your recording after the announcement "Record Memo Message" and a confirmation tone. The message counter displays "--".
- 3) When you have finished, press **memo rec**, \triangleright/\square , or **set** to stop recording. The system returns to standby.



- The voice memo messages are recorded as an incoming messages.
- When the answering system is full, "FL" appears on the display and recording is terminated.
- If an outside call is received during the operation, the operation is canceled.

Recording a conversation

You can record a conversation from the handset or the base (more than 2 seconds and within 10 minutes).



- A recorded conversation is treated as an incoming message and will be added to the stored messages.
- You cannot record 3-way or intercom conversations.
- When the answering system becomes full, "FL" appears on the display and recording is terminated.

From the handset

- 1) During a conversation, press the **MENU** soft key on the handset.
- 2) Press **volume/ ▲** or **▼** to select "Recording", then press the **OK** soft key.  appears on the handset, and "--" flashes on the base.
A confirmation tone, that can be heard by both parties, sounds during recording.
- 3) Press the **STOP** soft key to finish recording. You will hear a confirmation tone.

From the base

- 1) During a conversation using the base speaker phone, press and hold **memo rec** on the base until you hear a confirmation tone. The unit begins recording and "--" flashes on the display.
A confirmation tone, that can be heard by both parties, sounds during recording.
- 2) To stop recording, press \triangleright/\square or **memo rec**. You hear a confirmation tone.

Remote Operation

You can operate your answering system from a remote location using any touch-tone telephone or the handset.

Remote access away from home

You can check, play, or delete messages, even record a new greeting message when you are away from home. Additionally, you can turn On or Off your answering system from a remote location.



- Time stamp will not be heard until you have set the time. see “Setting the Time” on page 54.
- The system will only playback messages for four minutes and then it returns to the command waiting mode. To continue playing your messages, press **0** then **2** again within 15 seconds.
- If you enter an incorrect PIN code three times, you will hear a beep and the system will return to standby.
- During the remote operation, “Lr” appears on the base.

- 1) Call your telephone number and wait for the system to answer. If the answering system is off, it will answer after about 10 rings and sounds a series of beeps.
- 2) During the greeting message (or a series of beeps when the answering system is off), press **0** and enter your PIN code within 2 seconds (see “Setting a PIN Code” on page 27 or 54).
- 3) The answering system announces the current time and the number of messages stored in memory. You hear “To play incoming messages, press zero-two. For help, press one-zero”. You will hear a beep.
- 4) Enter a command within 15 seconds, each command there after must be entered within 2 seconds. You may select a command from the following chart:



For your convenience a remote operation card is provided for you to use while away from home (refer to page 79).

Command	Function
0 then 1	Repeat a Message*
0 then 2	Playing incoming Messages
0 then 3	Skipping a Message
0 then 4	Deleting a Message
0 then 5	Stop Operation

Command	Function
0 then 6	Answering System On
0 then 7	Memo Record/Stop **
0 then 8	Greeting Message Record/Stop **
0 then 9	Answer System Off
1 then 0	Help Guidance

- * For Repeat a Message function, press **0** then **1** within about four seconds to repeat the previous message, or press **0** then **1** after about four seconds to repeat the current message.
- ** For Memo Record and Greeting Message Record function, the first time you enter the corresponding command, it starts the Recording function. If you want to stop the recording, press **0** then **7** or **8**.
- 5) After the command has finished, you hear intermittent beeps indicating that the system is in the command waiting mode. You may enter another command at this time from the chart above.
- 6) When you are finished, hang up to exit the system. The answering system automatically returns to standby.

Remote access with the handset

You can check your new incoming messages, skip, repeat, or delete your incoming messages with the handset. For example, you can install the answering system in the living room, and check your incoming message from a bedroom with the handset. You can also use speakerphone on the handset for remote operation (see “Making and receiving calls” on page 31).





- If you press the **end** key before the answering system answers, the phone will return to standby.
- When the answering system does not answer within 6 seconds, you hear a beep and the phone will return to standby.
- The base’s keypad is disabled during remote operation.
- When you receive a call, the remote operation is canceled.
- You can change the handset volume during a remote operation.
- During the remote operation “r-P” appears on the base.

Playing incoming messages



- 1) When the phone is in the standby mode, press the  soft key on the handset. "Remote Playback" appears on the handset display. The answering system announces the current time and the number of messages stored in the memory. Messages will be played in the order in which they were received. The time and day that each message was received is announced after the message is played.
- 2) When you are finished, hang up to exit the system. The answering system automatically returns to standby.

When the last message has been played, the system announces "End of messages". And the system returns to standby.

Repeating a message

After a message begins playing, press the  soft key within about four seconds to repeat the previous message, or press the  soft key after about four seconds to repeat the current message.



Skipping a message

While the message is playing, press the  soft key on the handset. Each time the  soft key is pressed, the system scans forward one message.

Deleting a message

While the message is playing, Press the **DELETE** soft key on the handset. The message playing is deleted.



- If you have new messages and old messages, only the new messages will be played. After you have reviewed your new messages, you can play your old messages by again pressing the  soft key. Once you have listened to a new message, it then becomes an old message.
- If you have new messages and old messages, only the new messages will be repeated.
- If you press the  soft key while the earliest message is playing, you can repeat only the current message.



- To use the DCX520, register it to the DCT5280 series base.
- Save this manual for the detailed operation.
- All of the handsets ring when a call is received.

Expanding Your Phone

Your phone supports up to 4 handsets (including the handset(s) supplied with your phone). You can now place a fully featured cordless handset anywhere AC power is available to connect the handset charger.

Effective combinations, for example:

- 4-way conferencing (the base, 2 handsets, and one outside line), while on an intercom call using the other 2 handsets, or
- 4-way conferencing (3 handsets and an outside line)

IMPORTANT:

- If you purchase a DCX520 extra handset, please register the handset to the DCT5280 series base before use. The DCX520 will not operate until it is registered.
- If you change a setting of the Global Setup menu in one of the handsets, you change settings for all the handsets. For all other features they must be set separately through each handset.

Connecting the Charger

- 1) Connect the AC adapter to the **DC IN 9V** jack and to a standard 120V AC wall outlet.
- 2) Set the charger on a desk or tabletop, and place the handset in the charger with the keypad facing forward.
(See "B. Install the AA batteries into the handset" on page 13).

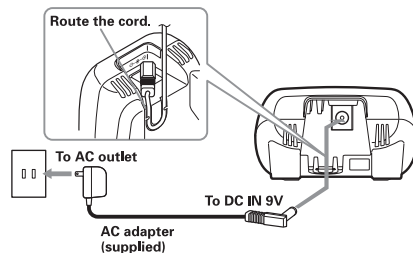

Register the Handset

If you purchase an extra handset, you need to register the handset before use. Only one handset can be registered at a time.

The handset ID for the supplied handset(s) was assigned at the factory, which has #1 (#1 and #2 for DCT5280-2) in the display. When you register additional handsets to the base, the handset ID will be assigned.

- 1) Before registering the extra handset, charge the phone's battery for 10 minutes.
- 2) Place the extra handset in the main base unit to begin registration.
- 3) While the handset is registering, "Handset Registering" will appear in the LCD. When "Registration Complete" is displayed, the handset has been registered to the base. If "Registration Failed" appears, please try these steps again.
- 4) Place the handset back in the charging cradle and fully charge the phone's battery for 17 to 20 hours.



An extra handset can be registered when the base is in the standby mode.

Using the DirectLink Mode

To use this feature, you must enter the two handsets into the DirectLink mode first.

To enter the DirectLink mode ⇨ See page 24



- During DirectLink Mode, batteries use time when fully charged is as follows:
 - Up to 7 hours continuous use.
 - Up to 24 hours in the standby mode.
- Placing the handset in the cradle causes the handset to exit the DirectLink mode.

DirectLink call

- 1) When the phone is in the DirectLink standby mode, press the **DirectLink** soft key. (Example of DirectLink from handset #1).
- 2) Select the party by pressing the number keys (**1-4**). Your handset will page the other handset.
- 3) On the receiving handset, press **talk** or the **ANSWER** soft key, or any number key, ***/tone/◀**, or **#/▶** (when Anykey Answer is On).
- 4) When you finish your conversation, press the **end** key or the **END** soft key on either handset.
Return the handset to the cradle, or press the **CANCEL** soft key then the **OK** soft key to return to normal mode.

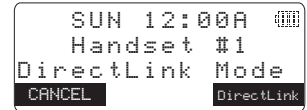

4-Way Conferencing

Fourth person, at either the handset or the base, may be added to the conference call. For example, to add a fourth party to an ongoing conference call at the base or another handset, press **talk/flash** on the fourth party's handset (or **☎** (talk) on the base). To remove either caller from your conversation, press the **end** key on the party's handset (or **☎** (talk) on the base). The other parties will still be connected to the call.

Intercom/Call Transfer Feature

Intercom and Call Transfer features are available for your phone.



- If the party is busy or out of range, you will hear a beep and the handset returns to the standby mode.
- If any of the following occurs, the operation will be canceled.
 - Press **talk/flash** or **speaker** on the handset, and **☎** (talk) on the base.
 - Receive an outside/intercom call (while selecting the other handset).
- When the party does not answer within 1 minute, Intercom or Call Transfer is canceled.

Intercom

From handset to handset or to the base

- 1) Press **intercom/hold** in the standby mode.
- 2) Select the base or the handset you want to talk with from the selection list within 30 seconds. To select the handset (or the base), press **volume/▲** or **▼**, then press the **OK** soft key.

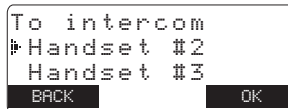

If you select "R11", all handsets and the base will be paged. An intercom tone sounds.



- 3) On the receiving handset (or the base), to answer the call, press **talk/flash**, **intercom/hold**, or the **ANSWER** soft key (or **intercom** or **☎** (talk) on the base). Or press any number key, ***/tone/◀**, or **#/▶** (when Any Key Answer is On), or pick up the handset from the cradle (when AutoTalk is On).
- 4) To hang up the intercom call, press the **end** key or the **END** soft key on either handset (or **intercom** on the base).

From the base to a handset

- 1) Press **intercom** on the base in the standby mode.
- 2) All the handsets will be paged.
- 3) On the receiving handset, to answer the call, press **talk/flash**, **intercom/hold**, or the **ANSWER** soft key. Or press any number key, ***/tone/◀**, or **#/▶** (when Any Key Answer is On), or pick up the handset from the cradle (when AutoTalk is On).
- 4) To hang up the intercom call, press the **end** key or the **END** soft key on the handset or **intercom** on the base.

Call Transfer Feature

From handset to handset or to the base

- 1) During a call, press **intercom/hold** on the handset.
- 2) Select a handset or the base to transfer the call to within 10 seconds (refer to step 2 under “Intercom” section). The call will automatically be placed on hold, and an intercom tone sounds. To cancel the transfer, press the **CANCEL** soft key, **talk/flash**, **speaker**, or the **BACK** soft key on the initiating handset.
- 3) On the receiving handset, to answer the page, press **talk/flash**, **intercom/hold**, or the **ANSWER** soft key (or  (talk) or **intercom** on the base). Or press any number key, ***/tone/◀**, or **#/▶** (when Any Key Answer is On), or pick up the handset from the cradle (when AutoTalk is On). The intercom mode is activated, but the caller is still on hold.
- 4) To speak to the caller, press **talk/flash** or **speaker** (or  (talk) on the base) on the receiving handset.

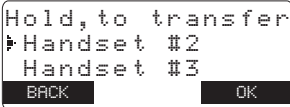

Hold, to transfer
▶ Handset #2
Handset #3
BACK OK

From the base to a handset

- 1) During a call, press **intercom** on the base. The call will automatically be placed on hold, and an intercom tone sounds. All the handset(s) will be paged.
- 2) On the receiving handset, to answer the call, press **talk/flash**, **intercom/hold**, or the **ANSWER** soft key. The intercom mode is activated, but the caller is still on hold. Or press any number key, ***/tone/◀**, or **#/▶** (when Any Key Answer is On), or pick up the handset from the cradle (when AutoTalk is On).
- 3) To speak to the caller, press **talk/flash**, or **speaker** on the receiving handset.

Replacing the Base

When you replace the base with a different base of the DCT series model (DCT5260, DCT5280, or DCT5285 series), you need to clear the handset and base ID. To do this, perform the “System Reset” menu options (“De-register the Handset” and “Replacing the Base Setting” (see page 30), then register all the handsets you have (see page 65).

Changing the Digital Security Code

The digital security code is an identification code used to connect the handset and the base unit. Normally, setting the code is not necessary. In the rare situation that you suspect another cordless telephone is using the same security code, you can change the code. To change the digital security code:

1. Perform the "System Reset" menu options ("De-register the Handset" and "Replacing the Base Setting") for all the handsets you have (see "System Reset" on page 30).
2. To register all the handsets do the following steps:
 - 1) Place a handset, one at a time in the base.
 - 2) Registration starts automatically.
While registering "Handset Registering" appears in the display.
 - 3) When the registration is complete, "Registration Complete" appears in the display.
 - 4) Repeat steps 1-3 for another handset(s).

If the registration fails, "Registration Failed" appears in the display. Try the steps above again.

Installing the Beltclip

To attach the beltclip

Insert the beltclip into the holes on each side of the handset.
Press down until it clicks.

To remove the beltclip

Pull both sides of the beltclip to release the tabs from the holes.



Headset Installation

Your phone may be used with an optional headset, the Uniden HS910. To use this feature, insert the headset plug into the headset jack. Your phone is ready for hands-free conversations. (Headset may be purchased by calling the Uniden Parts Department or visiting the web site. See page 11.)

Note on Power Sources

Battery replacement and handling

When the operating time becomes short, even after a battery is recharged, please replace the battery. Please use only "AA" rechargeable Ni-MH batteries.

Warning

To avoid the risk of personal injury or property damage from fire or electrical shock, only use the Uniden adapter model specifically designated for this product, and "AA" rechargeable Ni-MH batteries.

Power Failure

During the period that the power is off, you will not be able to make or receive calls with the telephone.

Caution

- Use only "AA" rechargeable Ni-MH batteries.
- Do not remove the batteries from the handset to charge them.
- Never throw the batteries into a fire, disassemble them, or heat them.
- Do not remove or damage the battery casing.

Maintenance

When the handset or base unit becomes slightly dirty

Wipe with a soft, dry cloth.

When the handset or base unit becomes very dirty

Wipe with a soft cloth that has been dampened with diluted, neutral detergent. Dry with a dry cloth.

When the charging contacts become very dirty on both the handset and base unit

Using water only, dampen a cloth to clean the charging contacts. Then make sure to go back over the charging contacts with a dry cloth before returning the handset to the base unit to charge.

Caution

Do not use paint thinner, benzene, alcohol, or other chemical products. Doing so may discolor the surface of the telephone and damage the finish.

General Information

The phone complies with FCC Parts 15 and 68. Operating temperature: 0 °C to +50 °C (+32 °F to +122 °F)

AC Adapter Information

AC Adapter part number:	AD-830 for the base	AD-310 for the charger (DCT5280-2 only)
Input Voltage:	120V AC 60Hz	120V AC 60Hz
Output Voltage:	9V DC 400 mA	9V DC 210 mA

Battery Information

Battery part number:	BT-211AR
Capacity:	1500 mAh, 1.2V
Battery use time (per charge) from fully charged:	
Talk mode duration (normal or DirectLink mode)	Up to 7 hours (up to 5 hours when the Clarity Booster is On)
Standby mode duration	Up to 14 days (up to 24 hours in DirectLink mode)



If the handset is left off of the cradle, the actual Talk mode duration will be reduced respective to the amount of time the handset is off the cradle.

Recharge your phone on a regular basis by returning the handset to the cradle after each phone call. When the operating time becomes short, even after the batteries are recharged, please replace the batteries.

A replacement Uniden adapter may be purchase at your local Uniden dealer or by contacting the Uniden Parts Department (800) 554-3988. Hours are from 8:00 a.m. to 5:00 p.m. CST, Monday through Friday. We can also be reached on the web at www.uniden.com.

For replacement batteries, use only "AA" rechargeable Ni-MH batteries. Do Not use Alkaline, Lithium, or non-rechargeable batteries. To insure maximum performance and safety, replacement batteries specifically matched for this phone, contact www.uniden.com. Using incorrect batteries could damage or limit the performance and could cause bodily injury.

Specifications, features, and availability of optional accessories are all subject to change without prior notice.

Troubleshooting

If your phone is not performing to your expectations, please try these simple steps first.

Symptom	Suggestion
The charge LED won't illuminate when the handset is placed in the cradle.	<ul style="list-style-type: none">• Make sure the AC adapter is plugged into the base (or the charger (for DCT5280-2 only)) and wall outlet.• Make sure the handset is properly seated in the base.• Make sure the charging contacts on the handset and the base (or the charger (for DCT5280-2 only)) are clean.
The audio sounds weak and/or scratchy.	<ul style="list-style-type: none">• Move the handset and/or base to a different location away from metal objects or appliances and try again.• Make sure that you are not too far from the base.
Can't make or receive calls.	<ul style="list-style-type: none">• Check both ends of the base telephone line cord.• Make sure the AC adapter is plugged into the base and wall outlet.• Disconnect the AC adapter for a few minutes, then reconnect it.• Remove the base ID (see "Replacing the Base Setting" on page 30) and register the handset (see "Register the Handset" on page 65).• Make sure that you are not too far from the base.• If an outside call is already established, you may not be able to make another outside call.
Can't make an internal call.	<ul style="list-style-type: none">• Make sure that the receiving handset is not already in use.• Make sure that the handset or the base is in the standby mode.• When a handset is recording a conversation, an intercom call from the base is not available. Make sure a handset is not recording a conversation.
The handset or the base doesn't ring or receive an intercom call.	<ul style="list-style-type: none">• Charge the batteries in the handset for 17-20 hours by placing the handset on the base or charging cradle.• The handset may be too far away from the base unit.• Place the base unit away from appliances or metal objects.• Remove the base ID (see "Replacing the Base Setting" on page 30) and register the handset (see "Register the Handset" on page 65).
"Unavailable" appears in the display.	<ul style="list-style-type: none">• Make sure that another handset(s) or the base is not in use, and try the phone again.• Make sure that you are not too far from the base.
Severe noise interference.	<ul style="list-style-type: none">• Keep the handset away from microwave ovens, computers, remote control toys, wireless microphones, alarm systems, intercoms, room monitors, fluorescent lights, and electrical appliances.• Move to another location or turn off the source of interference.

Symptom	Suggestion
The Caller ID does not display.	<ul style="list-style-type: none"> • The handset was picked up before the second ring. • The call was placed through a switchboard. • Call your local telephone company to verify your Caller ID service is current.
You cannot register the handset at the base.	<ul style="list-style-type: none"> • Please make sure your batteries are charged at least 10 minutes (see “Register the Handset” on page 65). • Remove the base ID (see “Replacing the Base Setting” on page 30) and register the handset (see “Register the Handset” on page 65). • Only 4 handsets can be registered to the base.
The handset doesn't communicate with the base or other handsets.	<ul style="list-style-type: none"> • Remove the base ID (see “Replacing the Base Setting” on page 30) and register the handset (see “Register the Handset” on page 65). • Make sure that you have registered all handsets (DCX520 only).
The handset or the base can't join the conversation.	<ul style="list-style-type: none"> • Make sure that more than 3 handsets (or 2 handsets when the base is used for the conference) are not in use. • When recording a conversation, the 2nd handset (or the base) cannot join the conversation.
The answering system does not work.	<ul style="list-style-type: none"> • Make sure the base unit is plugged in. • Make sure that the answering system is turned On. • Make sure that the message record time is not set to Announce only (see page 55).
Messages are incomplete.	<ul style="list-style-type: none"> • The incoming messages may be too long. Remind callers to leave a brief message. • The memory may be full. Delete some or all of the saved messages.
After a power failure, the outgoing message is deleted.	<ul style="list-style-type: none"> • Record your greeting again. The default message should remain.
No sound on the base unit speaker during call monitoring or message playback.	<ul style="list-style-type: none"> • Adjust the speaker volume on the base unit. • Make sure the call screen feature is set to On.
Cannot access remote call-in features from another touch-tone phone.	<ul style="list-style-type: none"> • Make sure you are using the correct PIN number. • Make sure that the touch-tone phone you're using can transmit the tone for at least two seconds. If it cannot, you may have to use another phone to access your phone.
Time stamp cannot be heard.	<ul style="list-style-type: none"> • Make sure you have set the time (see “Setting Day and Time” on page 29 or “Setting the Time” on page 54).
If you still have a problem.	<ul style="list-style-type: none"> • Call our customer hotline at 1-800-297-1023.

Liquid Damage

Moisture and liquid can damage your cordless phone. In case of accidental submersion, please read the following steps.

Case	Action
If the handset or base is exposed to moisture or liquid, but only affects the exterior plastic housing.	Wipe off the liquid and use as normal.
If moisture or liquid has entered the plastic-housing (i.e. liquid can be heard in the phone or liquid has entered the handset battery compartment or vent openings on the base).	<p>Handset:</p> <ol style="list-style-type: none">1) Remove the battery cover and leave it off for ventilation.2) Remove the batteries by disconnecting.3) Leave the battery cover off and the batteries disconnected for at least 3 days.4) Once completely dry, reinstall the batteries and the battery cover.5) Recharge the handset's batteries for 20 hours in the base unit before using the phone. <p>Base:</p> <ol style="list-style-type: none">1) Disconnect the AC adapter from the base unit, cutting off electrical power.2) Disconnect the telephone cord from the base unit.3) Let dry for at least 3 days. <p>IMPORTANT: You must unplug the telephone line while recharging the batteries to avoid charge interruption.</p> <p>CAUTION: DO NOT use a microwave oven to speed up the drying process. This will cause permanent damage to the handset, base and the microwave oven. After following these steps, if your cordless telephone does not work, please send to: Uniden America Corporation Parts and Service Division 4700 Amon Carter Blvd. Ft. Worth TX76155 1-800-554-3988. Monday through Friday 8 a.m. to 5 p.m. CST</p>

Precautions!

Before you read anything else, please observe the following:

Warning!

Uniden America Corporation DOES NOT represent this unit to be waterproof. To reduce the risk of fire, electrical shock, or damage to the unit, DO NOT expose this unit to rain or moisture.

Rechargeable Nickel-Metal-Hydride Battery Warning

- This equipment contains a rechargeable Nickel-Metal-Hydride battery.
- Nickel is a chemical known to state of California to cause cancer.
- The rechargeable Nickel-Metal-Hydride battery contained in this equipment may explode if disposed of in a fire.
- Do not short-circuit the battery.
- Do not charge the rechargeable Nickel-Metal-Hydride battery used in this equipment in any charger other than the one designed to charge this battery as specified in the owner's manual. Using another charger may damage the battery or cause the battery to explode.

Rechargeable Nickel-Metal-Hydride Batteries Must Be Recycled or Disposed of Properly



The exclamation point within an equilateral triangle is intended to alert the user to the presence of important operating and maintenance (servicing) instructions in the literature accompanying the appliance.

Uniden works to reduce lead content in our PVC coated cords in our products and accessories.

WARNING:

The cords on this product and/or accessories contain lead, a chemical known to the State of California to cause birth defects or other reproductive harm. **Wash hands after handling.**

Important Safety Instructions

When using your telephone equipment, these basic safety precautions should always be followed to reduce the risk of fire, electrical shock, and injury to persons:

1. Read and understand all instructions.
2. Follow all warnings and instructions marked on the product.
3. Unplug this product from the wall outlet before cleaning. Use a dry cloth for cleaning without liquid or aerosol cleaners.
4. Do not use this product near water; for example, near a bathtub, wash bowl, kitchen sink or laundry tub, in a wet basement, or near a swimming pool.
5. Do not place this product on an unstable cart, stand, or table. The telephone may fall, causing serious damage to the unit.
6. Slots and openings in the cabinet and the back or bottom are provided for ventilation. To protect the product from overheating, these openings must not be blocked or covered. This product should never be placed near or over a radiator or heat register. This product should not be placed in a built-in installation unless proper ventilation is provided.
7. This product should be operated only from the type of power source indicated on the marking label. If you are not sure of the type of power supply to your home, consult your dealer or local power company.
8. Do not allow anything to rest on the power cord. Do not locate this product where the cord will be damaged by persons walking on it.
9. Do not overload wall outlets and extension cords, as this can result in the risk of fire or electrical shock.
10. Never push objects of any kind into this product through cabinet slots, as they may touch dangerous voltage points or short out parts that could result in a risk of fire or electric shock. Never spill liquid of any kind on the product.
11. To reduce the risk of electric shock, do not disassemble this product. Take it to qualified service personnel when service or repair work is required. Opening or removing covers may expose you to dangerous voltages or other risks. Incorrect reassembly can cause electric shock when the appliance is subsequently used.
12. Unplug this product from the wall outlet and refer servicing to qualified service personnel under the following conditions:
 - A. When the power supply cord is damaged or frayed.
 - B. If liquid has been spilled into the product.
 - C. If the product has been exposed to rain or water.
 - D. If the product does not operate normally when following the operating instructions. (Adjust only those controls that are covered by the operating instructions. Improper adjustment of other controls may result in damage and will often require extensive repair work by a qualified technician.)
 - E. If the product has been dropped or the cabinet has been damaged.
 - F. If the product exhibits a distinct change in performance.
13. Do not use the telephone to report a gas leak in the vicinity of the leak.

Additional Battery Safety Precautions

Caution! To reduce the risk of fire or injury to persons by the battery, read and follow these instructions:

1. Use only the batteries specified in the owner's manual.
2. Do not dispose of the batteries in a fire. The cell may explode. Check the Nickel Metal Hydride battery disposal package insert for disposal instructions.
3. Do not open or mutilate the batteries. Released electrolyte is corrosive and may cause damage to the eyes or skin. It may be toxic if swallowed.
4. Exercise care in handling the battery in order not to short the battery with conducting materials such as rings, bracelets, and keys. The battery or conductor may overheat and cause burns.
5. Charge the batteries provided with or identified for use with this product only in accordance with the instructions and limitations specified in the owner's manual provided for this product.
6. Observe proper polarity orientation between the batteries and battery charger.

SAVE THESE INSTRUCTIONS!

Important Electrical Considerations

Unplug all electrical appliances when you know an electrical storm is approaching. Lightning can pass through your household wiring and damage any device connected to it. This phone is no exception.

The FCC Wants You To Know

Changes or modifications to this product not expressly approved by Uniden, or operation of this product in any way other than as detailed by the owner's manual, could void your authority to operate this product. Your telephone complies with Part 68 of FCC Rules. You must, upon request, provide the FCC registration number and the REN to your telephone company. Both numbers are on the base unit.

Note: You must not connect your phone to:

- coin-operated systems
- most electronic key telephone systems

Range

Your new phone is designed to achieve the maximum possible range by transmitting and receiving according to the highest specifications set forth by the FCC. We have rated this phone to operate at a maximum distance with the qualification that the range depends upon the environment in which the telephone is used. Many factors limit range, and it would be impossible to include all the variables in our rating. The Maximum Range rating of this phone is meant to be used as a means of comparison against other range claims.

Telephone Line Problems

The FCC has granted the telephone company the right to disconnect service in the event that your phone causes problems on the telephone line. Also, the telephone company may make changes in facilities and services which may affect the operation of your unit. However, your telephone company must give adequate notice in writing prior to such actions to allow you time for making necessary arrangements to continue uninterrupted service. If you are having trouble with your telephone service, you must first disconnect your phone to determine if it is the cause of your problem. If you determine that it is the cause, you must leave it disconnected until the trouble has been corrected.

Radio Interference

Radio interference may occasionally cause buzzing and humming in your cordless handset, or clicking noises in the base. This interference is caused by external sources such as TV, refrigerator, vacuum cleaner, fluorescent lighting, or electrical storm. Your unit is NOT DEFECTIVE. If these noises continue and are too distracting, please check around your home to see what appliances may be causing the problem. In addition, we recommend that the base not be plugged into a circuit that also powers a major appliance because of the potential for interference. Be certain that the antenna on the unit is fully extended when needed.

In the unlikely event that you consistently hear other voices or distracting transmissions on your phone, you may be receiving radio signals from another cordless telephone or other source of interference. If you cannot eliminate this type of interference, you need to change to a different channel.

Finally, it should be noted that some cordless telephones operate at frequencies that may cause interference to nearby TVs and VCRs. To minimize or prevent such interference, the base of the cordless telephone should not be placed near or on top of a TV or VCR. If interference is experienced, moving the cordless telephone farther away from the TV or VCR will often reduce or eliminate the interference.

More than One Cordless Telephone

If you want to use more than one cordless telephone in your home, they must operate on different channels. Press the channel key to select a channel that provides the clearest communication.

Cordless Telephone Privacy

Cordless telephones are radio devices. Communications between the handset and base of your cordless telephone are accomplished by means of radio waves which are broadcast over the open airways. Because of the inherent physical properties of radio waves, your communications can be received by radio receiving devices other than your own cordless telephone unit. Consequently, any communications using your cordless telephone may not be private.

Installation Considerations

Selecting a Location

Before choosing a location for your new phone, there are some important guidelines you should consider:

- The location should be close to both a phone jack and continuous power outlet. (A continuous power outlet is an AC outlet which does not have a switch to interrupt its power.)
- Keep the base and handset away from sources of electrical noise such as motors or fluorescent lighting.
- The base can be placed on a desk or tabletop or mounted on a standard telephone wall plate.
- You should charge your new phone for 17-20 hours before completing the installation or using the handset.

Telephone Line Outlets

There are two types of phone outlets:

Modular Jack

Most phone equipment available now uses modular jacks. Phone cords are fitted with a molded plastic connector which plugs into this type of jack. If you do not have modular phone jacks, contact your local telephone company for information about their installation.

Hardwired Jack

Some equipment is wired directly to a phone jack, and these types of installations require a modular jack converter. This type of installation is not difficult; however, you should contact your Uniden telephone dealer or a telephone supply store for advice about the proper adapter or converter for your particular situation.

Connecting the Telephone Cords

Consider these safety guidelines before connecting the telephone cords:

Caution!

- Never install telephone wiring during a lightning storm.
- Never touch uninsulated telephone wires or terminals unless the telephone line has been disconnected.
- Use caution when installing or modifying telephone lines.

Applying Power to the Base

This phone requires an AC outlet, without a switch to interrupt power, and the included AC adapter. To relieve strain on the DC plug when the phone is placed on a desk or table, wrap the power cord around the strain relief notch on the bottom of the base.

NOTE: Place the power cord so that it does not create a trip hazard, or where it could become chafed and create a fire or other electrical hazards.

One Year Limited Warranty

Important: Evidence of original purchase is required for warranty service.

WARRANTOR: UNIDEN AMERICA CORPORATION ("Uniden")

ELEMENTS OF WARRANTY: Uniden warrants, for one year, to the original retail owner, this Uniden Product to be free from defects in materials and craftsmanship with only the limitations or exclusions set out below.

WARRANTY DURATION: This warranty to the original user shall terminate and be of no further effect 12 months after the date of the original retail sale. The warranty is invalid if the Product is (A) damaged or not maintained as reasonable or necessary, (B) modified, altered, or used as part of any conversion kits, subassemblies, or any configurations not sold by Uniden, (C) improperly installed, (D) serviced or repaired by someone other than an authorized Uniden service center for a defect or malfunction covered by this warranty, (E) used in any conjunction with equipment or parts or as part of any system not manufactured by Uniden, or (F) installed or programmed by anyone other than as detailed by the owner's manual for this product.

STATEMENT OF REMEDY: In the event that the product does not conform to this warranty at any time while this warranty is in effect, warrantor will either, at its option, repair or replace the defective unit and return it to you without charge for parts, service, or any other cost (except shipping and handling) incurred by warrantor or its representatives in connection with the performance of this warranty. Warrantor, at its option, may replace the unit with a new or refurbished unit. THE LIMITED WARRANTY SET FORTH ABOVE IS THE SOLE AND ENTIRE WARRANTY PERTAINING TO THE PRODUCT AND IS IN LIEU OF AND EXCLUDES ALL OTHER WARRANTIES OF ANY NATURE WHATSOEVER, WHETHER EXPRESS, IMPLIED OR ARISING BY OPERATION OF LAW, INCLUDING, BUT NOT LIMITED TO ANY IMPLIED WARRANTIES OF MERCHANTABILITY OR FITNESS FOR A PARTICULAR PURPOSE. THIS WARRANTY DOES NOT COVER OR PROVIDE FOR THE REIMBURSEMENT OR PAYMENT OF INCIDENTAL OR CONSEQUENTIAL DAMAGES. Some states do not allow this exclusion or limitation of incidental or consequential damages so the above limitation or exclusion may not apply to you.

LEGAL REMEDIES: This warranty gives you specific legal rights, and you may also have other rights which vary from state to state. This warranty is void outside the United States of America and Canada.

PROCEDURE FOR OBTAINING PERFORMANCE OF WARRANTY: If, after following the instructions in the owner's manual you are certain that the Product is defective, pack the Product carefully (preferably in its original packaging). The Product should include all parts and accessories originally packaged with the Product. Include evidence of original purchase and a note describing the defect that has caused you to return it. The Product should be shipped freight prepaid, by traceable means, to warrantor at:

Uniden America Corporation
Parts and Service Division
4700 Amon Carter Blvd.
Fort Worth, TX 76155

1-800-297-1023, 8 a.m. to 5 p.m. CST, Monday through Friday

I.C. Notice

TERMINAL EQUIPMENT

NOTICE: This equipment meets the applicable Industry Canada Terminal Equipment Technical Specifications. This is confirmed by the registration number. The abbreviation, IC, before the registration number signifies that registration was performed based on a Declaration of Conformity indicating that Industry Canada technical specifications were met. It does not imply that Industry Canada approved the equipment.

NOTICE: The Ringer Equivalence Number (REN) for this terminal equipment is marked on the equipment itself. The REN assigned to each terminal equipment provides an indication of the maximum number of terminals allowed to be connected to a telephone interface. The termination on an interface may consist of any combination of devices subject only to the requirement that the sum of the Ringer Equivalence Numbers of all the devices does not exceed five.

RADIO EQUIPMENT

The term "IC:" before the radio certification number only signifies that Industry Canada technical specifications were met.

Operation is subject to the following two conditions: (1) this device may not cause interference, and (2) this device must accept any interference, including interference that may cause undesired operation of the device. "Privacy of communications may not be ensured when using this telephone".

Index

0 - 9

- 3-way conferencing36
- 4-way conferencing66
- 16 ring options25

A

- Announce only feature56
- Answering system
 - Deleting a message59
 - Playing your messages58
 - Recording a conversation60
 - Remote access.....61
 - Repeating a message58
 - Skipping a message59
 - Turning On/Off.....28, 51

- Anykey answer.....26
- Area code29
- AutoTalk.....25

B

- Banner26
- Base speaker volume53
- Battery
 - Preparing and charging13
 - Replacement and handling.....70
- Beltclip69
- Booster35

C

- Caller ID
 - Caller ID service45
 - Calling48
 - Call Waiting.....29, 49
 - Deleting47
 - Setting.....29

- Storing.....48
- Using.....48
- Viewing46
- Call transfer feature68
- Chain dialing44
- Clock29, 54
- Conversation, recording60

D

- Deluxe Call Waiting features49
- De-register the handset30
- Dialing mode15, 30
- Digital security code10, 69
- Distinctive ringer.....25

E, F, G, H

- Earpiece volume.....34
- Expanding your phone64
- Hands-free conversation31
- Headset installation69

I, J, K, L

- I.C. Notice77
- Important safety instructions.....75
- Intercom67
- Language
 - handset26
 - base57
- LCD contrast26
- Liquid damage.....74

M, N, O

- Maintenance70
- Making a call31
- Mute34
- New message LED.....37

- Outgoing message51

P, Q

- Phonebook38
 - Editing.....43
 - Erasing.....43
 - Making calls43
 - Storing.....38
 - Viewing42
- Precautions.....75

R

- Receiving a call31, 32
- Redialing a call33
- Register the handset65
- Remote access
 - away from home61
 - from your handset62
- Replacing the base.....68
- Ring volume
 - handset24
 - base52

S

- Setting up
 - base unit12
 - extra handset64
 - handset13
- Soft key function.....9
- Speed dialing43

T, U, V, W, X, Y, Z

- Transferring a call67
- Voice memo60
- Warranty.....76

Remote Operation Card

CUT

REMOTE OPERATION CARD

Uniden®

Remote access away from home

1. Call your phone number from a touch-tone phone.
2. During the outgoing message, press 0 and enter your PIN code. The answering system announces the number of messages stored in memory and the help guidance.
3. To quit, hang up the phone.

Turn on the answering system remotely

1. Call your phone and let it ring 10 times until you hear a beep.
2. Press 0 and then enter your PIN code.
3. Press 0 then 5 to stop the announcement.
4. Press 0 then 6 to turn the answering system on.

CUT

Task	Key
Repeat a Message	0 1
Playing incoming Messages	0 2 abc
Skipping a Message	0 3 def
Deleting a Message	0 4 ghi
Stop Operation	0 5 jkl
Answering System On	0 6 mno
Memo Record/Stop	0 7 pqrs
Greeting Message Record/Stop	0 8 tuv
Answer System Off	0 9 wxyz
Help Guidance	1 0 oper

At Uniden, we'll take care of you!

If you need any assistance with this product, please call our Customer Hotline at

1-800-297-1023

PLEASE DO NOT RETURN THIS PRODUCT TO THE PLACE OF PURCHASE.

Our Uniden representatives will be happy to help you with any matters regarding the operation of this unit, available accessories, or any other related matters.

Thank you for purchasing a Uniden product.
Hours: M-F 8:00 AM to 5:00 PM CST.



For information on the accessibility features of this product, please call

1-800-874-9314 (V/TTY)

Uniden®

May be covered under one or more of the following U.S. patents:

4,511,761	4,523,058	4,595,795	4,797,916	5,381,460	5,426,690
5,434,905	5,491,745	5,533,010	5,543,605	5,574,727	5,581,598
5,650,790	5,660,269	5,661,780	5,663,981	5,671,248	5,696,471
5,717,312	5,732,355	5,754,407	5,758,289	5,768,345	5,787,356
5,794,152	5,801,466	5,825,161	5,838,721	5,864,619	5,893,034
5,912,968	5,915,227	5,929,598	5,930,720	5,960,358	5,987,330
6,044,281	6,070,082	6,125,277	6,253,088		

EXPAND YOUR SYSTEM!

DCX 520 HANDSET + CHARGER

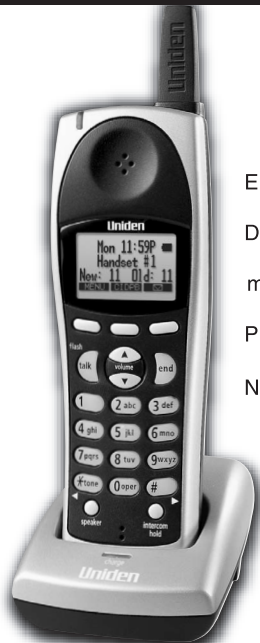

Easily expand your cordless phone system by adding the DCX 520 Handset and Charger*. The DCX 520 gives you the mobility you need to stay connected with friends and family.

Place this handset and charger in any convenient location.

No phone jack required.

* Accessory handset DCX 520 is compatible with models: DCT 5260, DCT 5280, and DCT 5285 Series.

©2003 Uniden America Corporation, Fort Worth, Texas. Contains additional foreign articles. Custom manufactured in China.

Download from www.Somanuals.com. All Manuals Search And Download.

Free Manuals Download Website

<http://myh66.com>

<http://usermanuals.us>

<http://www.somanuals.com>

<http://www.4manuals.cc>

<http://www.manual-lib.com>

<http://www.404manual.com>

<http://www.luxmanual.com>

<http://aubethermostatmanual.com>

Golf course search by state

<http://golfingnear.com>

Email search by domain

<http://emailbydomain.com>

Auto manuals search

<http://auto.somanuals.com>

TV manuals search

<http://tv.somanuals.com>