

# Start Here!

1

2

3

Quick Start Guide - next page ...



# DG72

Digital Spread Spectrum

provides the longest range,

the clearest sound

and the best privacy.

# QUICK START GUIDE

## Uniden



This symbol indicates important operating and servicing instructions.

## INSTALLATION & SAFETY

### Choosing the best location for your telephone.

When choosing a location for your phone there are a number of appliances the phone should not be near, and areas you should avoid.

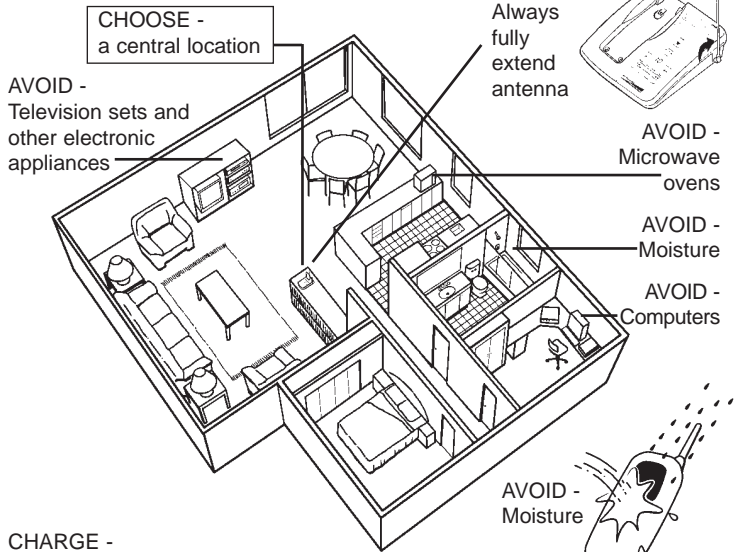

**CHARGE -**  
the new phone  
for 20 hrs and  
raise the  
antenna before  
making a call.

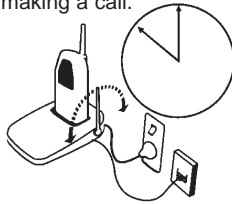

**DON'T -**  
overload the  
power outlet.

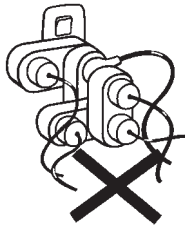

**AVOID -**  
multi power  
boards

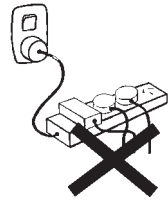

**AVOID -**  
Moisture

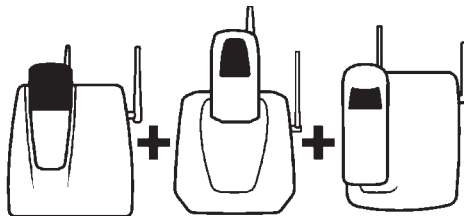

**AVOID -**  
connecting  
more than

**3**

phones as ringing  
may be impaired

PRECAUTIONS

*This page is a very condensed version of your owners manual. It is designed to allow you to get your phone installed and operating as quickly as possible - however it does not attempt to explain any of the advanced features of your phone.*

# Start Here!

# 1

# 2

# 3

# 1

## Installation

### CONNECTIONS

- 1 Plug the AC adaptor cord into base unit and then into a 240V AC outlet.
- 2 Connect the telephone cord to the phone, then plug into the phone jack in your home.
- 3 Place handset on base.
- 4 Select ringer and volume options on the handset and on the base.



Before connecting your phone line, fully charge the battery pack for 15-20 hours.

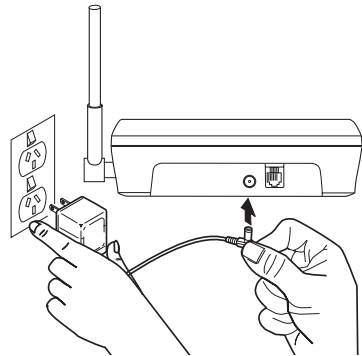

Use only the Uniden AC adaptor supplied with this phone and make sure it is switched on at all times.

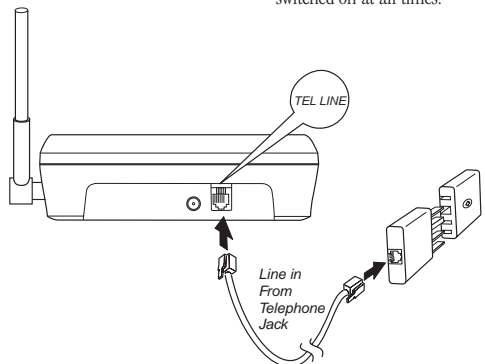

## 2

### Charging the Battery

#### Installing the Handset Batteries

- 1 Press battery cover to release. Slide cover off.

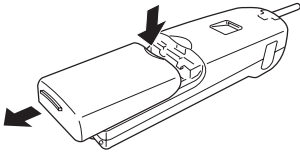

- 2 Align the plastic connector of the battery with its socket and press firmly until it clicks into place.

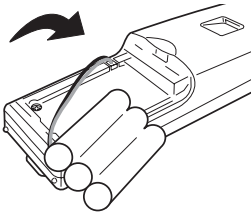

- 3 Place the battery pack inside. Please observe how the lead is positioned.

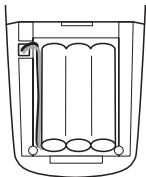

- 4 Slide the battery cover forward until it snaps into place.

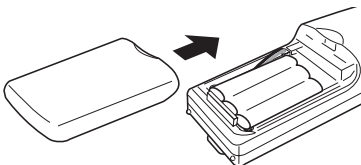

## 3

### Using the Phone

#### Adjusting the Handset Earpiece Volume

During a conversation, you can adjust the earpiece volume by pressing the **vol**



Louder — press the **vol** ▲

Softer — press the **vol** ▼

#### To Make a Call

- 1 Press **(talk)** (on the handset) and listen for dial tone or press **(speaker)** (on the base unit) and listen for dial tone.
- 2 Dial a number. (For memory dial feature, see “Using Memory Dialing” in your owner’s manual.)

#### To Hang Up

- 1 Press **(talk)** or return handset to base.

#### To Answer a Call

- 1 Handset on the Base —  
Remove handset from base and speak.
- 2 Handset off the Base —  
Lift handset, press **(talk)**, speak.
- 3 Press **(speaker)** button on the base unit, speak.

# CONTENTS

OF YOUR OWNERS MANUAL

## CONTENTS

<b>Precautions</b> . . . . .	Inside Front Cover
<b>Controls And Functions</b> . . . . .	2
<b>Introduction</b>	
Welcome . . . . .	4
Features . . . . .	4
Included In Your Package . . . . .	5
<b>Installing and Adjusting your Phone</b>	
Desk/Tabletop Installation . . . . .	6
Installing & Charging the Battery Pack . . . . .	8
Cleaning the Battery Contacts . . . . .	9
Adjusting the Volume Controls . . . . .	9
Adjusting the Ringer Tone . . . . .	9
Installing the Beltclip . . . . .	10
Automatic Digital Code Security . . . . .	10
<b>Using Your New Phone</b>	
Making and Receiving Calls . . . . .	11
Call Waiting . . . . .	12
Hold . . . . .	12
Mute . . . . .	13
Intercom . . . . .	13
Room Monitor . . . . .	13
Call Transfer . . . . .	13
Storing a Phone Number in Memory . . . . .	14
Dialing a Number In Memory . . . . .	15
Erasing a Stored Number from Memory . . . . .	15
Chain Dialing . . . . .	15
Travelling Out-Of-Range . . . . .	16
PABX Connection . . . . .	16
<b>Troubleshooting</b>	
Quick Reference Chart . . . . .	17
<b>Warranty</b> . . . . .	16

Introduction

Installing and  
Adjusting

Using Your  
New Phone

Troubleshooting

## CONTROLS & FUNCTIONS

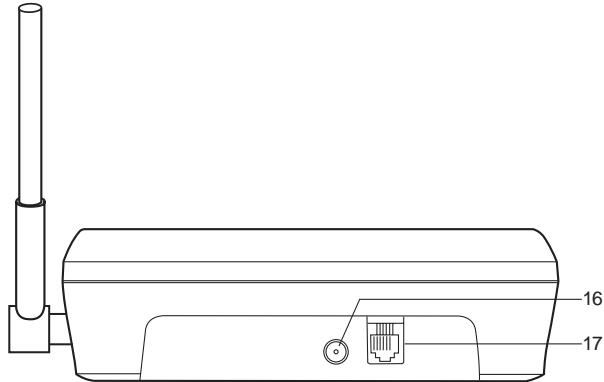

- |  |  |
|--|--|
| 1. Battery Compartment                 | A. <b>speaker</b> Button               |
| 2. Handset Antenna                     | B. Base Microphone                     |
| 3. <b>talk</b> Button                  | C. Power LED                           |
| 4. <b>redial</b> / <b>pause</b> Button | D. In use/Hold/Mute LED                |
| 5. Talk LED                            | E. Charge LED                          |
| 6. Battery Low LED                     | F. <b>redial</b> / <b>pause</b> Button |
| 7. <b>c.wait</b> Button                | G. Volume ▲▼ Button                    |
| 8. Numeric Keypad                      | H. <b>flash</b> Button                 |
| 9. <b>flash</b> Button                 | I. <b>mute</b> Button                  |
| 10. <b>int</b> Button                  | J. <b>int</b> Button                   |
| 11. <b>mem</b> Button                  | K. ★ Star Button                       |
| 12. Volume ▲▼ Button                   | L. <b>hold</b> Button                  |
| 13. Handset Microphone                 | M. <b>mem</b> Button                   |
| 14. # Hash Button                      | N. # Hash Button                       |
| 15. ★ Star Button                      | O. Numeric Keypad                      |
| 16. AC Adaptor                         | P. Speaker                             |
| 17. Tel Line                           | Q. Handset Retainer                    |

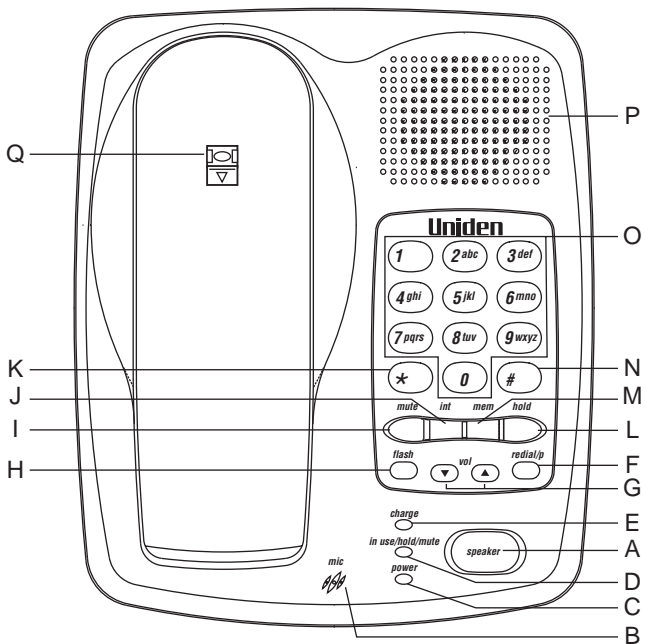
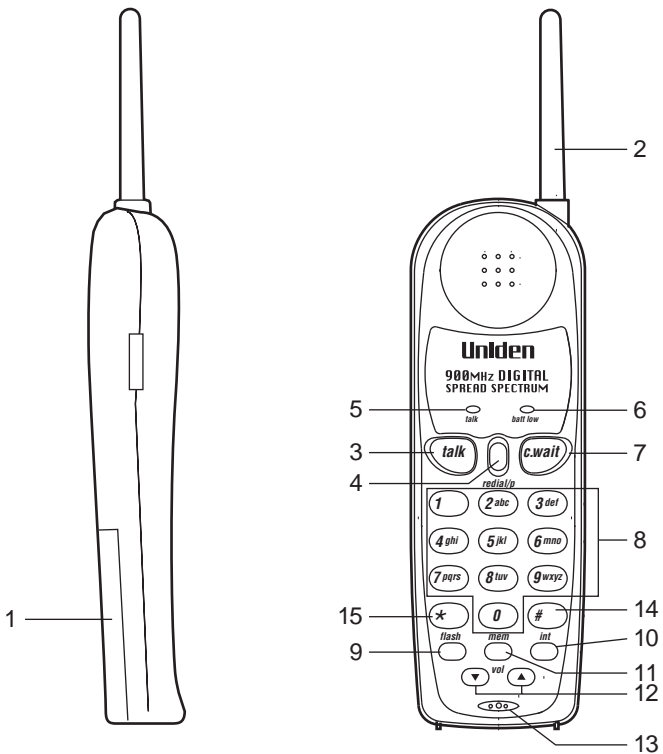

## WELCOME

Congratulations on your purchase of the Uniden **DG72** cordless telephone. This phone is designed for reliability, long life, and outstanding performance utilising the latest in 900 MHz Digital Spread Spectrum Technology.

## FEATURES

- 15 channels (Aust), 7 channels (NZ)
- 900 Digital MHz Spread Spectrum Technology
- Speakerphone
- Dual Keypad
- 40 Enhanced Memory Dial Locations (16 digits maximum per memory)
- 32 Digit Redial
- Redial, Flash, Pause, Mute and Hold
- Tone Dialing
- Call Waiting Compatible
- Page/Intercom system
- 14-Day Standby Battery Time
- 4-Hour Talk Time
- Handset Earpiece and Ringer Volume Control
- Hearing Aid Compatible
- Auto talk
- Auto Standby
- Any key Answer

**Digital Spread Spectrum Technology** utilises a digital transmission and a “wider frequency band” compared to a “single narrow band” 30/39 Standard Analogue transmission. The result is a more secure conversation with the clarity of digital sound, extended range, and minimal interference from other cordless phones.

**Random Code™** digital security automatically selects one of over 16 million codes for the handset and base. This feature prevents unauthorised calls as a result of your phone being activated by other equipment.



# INCLUDED IN YOUR PACKAGE



To get the most from your phone, please read this owner's manual thoroughly. Be sure to complete and mail the product registration form.



If any of these items are missing or damaged, contact your place of purchase.



Handset

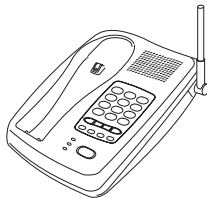

Base



Rechargeable Battery

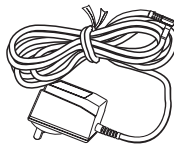

AAD 900S  
AC Adaptor

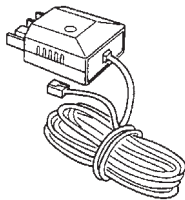

Long Telephone  
Cord/Plug

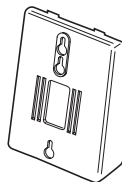

Wall Mount Adaptor

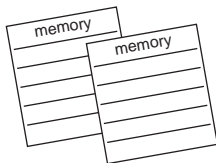

2 x Memory Stickers

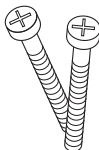

Wall Mounting Screws

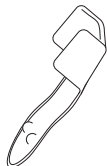

Belt Clip

- This Owner's Manual
- Registration Card
- and other printed materials



Be careful not to insert the mounting screws into possible electrical hazards such as cables, wiring, or pipes.

# INSTALLING

## AND ADJUSTING YOUR PHONE

### WALL INSTALLATION

1. Insert two mounting screws (with their appropriate anchoring device) into the wall 100mm apart. Allow about 5mm between the wall and screw heads for mounting the phone.

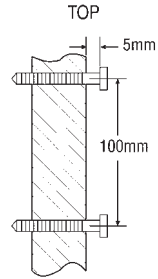

2. Snap the desktop/wall mount adaptor into the bottom of the base as shown.

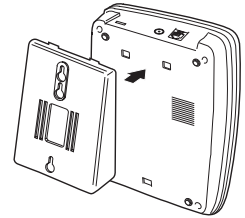

3. Plug the AC adaptor cord into the 9V DC input jack on the back of the base.
4. Put the AC adaptor cord inside the wall mount adaptor. Plug the AC adaptor into a standard 240V AC wall outlet.

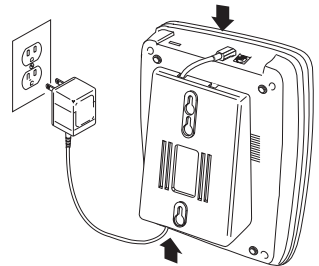

5. Plug one end of the telephone cord into the **TEL LINE** jack on the back of the base. Plug the other end into a telephone jack.

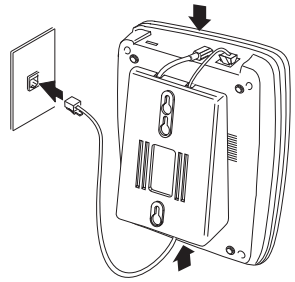

6. Align the mounting slots on the base with the mounting screws on the wall. Push in and down until the phone is firmly seated.

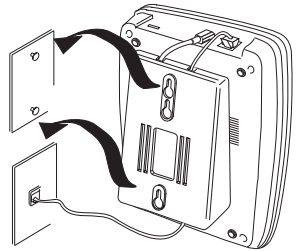

7. On the base, pull the handset retainer out of the slot. Rotate clockwise 180°.

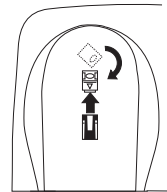

8. Flip the retainer from front to back. Slide it back into the slot so that the lip of the retainer is up (arrow on the retainer clip must be pointing down). The retainer holds the handset in place.

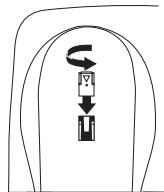

## INSTALLING & CHARGING THE BATTERY PACK



The battery connector will fit together only one way. Make sure the connector is properly aligned. Use only the Uniden battery pack (model BT-434)

### Installing the Battery Pack

The rechargeable battery pack must be fully charged before using your phone for the first time. Before plugging the phone line into your new phone, you must charge the battery for approximately 15-20 hours without interruption.

1. Remove the Handset battery cover.
2. Plug the battery's cable into the handset press the plug in firmly until it clicks into place. Place the battery pack inside the battery compartment.
3. Replace the battery cover.

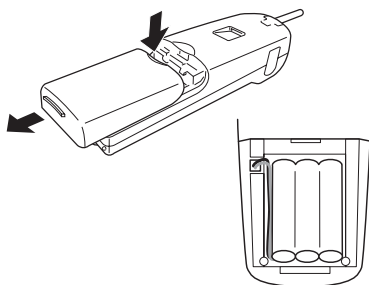

### Charging the Battery Pack

#### ▼ Initial battery charging

**Before connecting your the phone line for the first time, fully charge the rechargeable battery pack for 15-20 hours without interruption.**

1. Place the handset on the base (facing up or down).
2. Make sure that **charge** LED lights. If the LED doesn't light, be sure the AC adaptor is plugged in and the handset makes good contact with the base charging contacts.

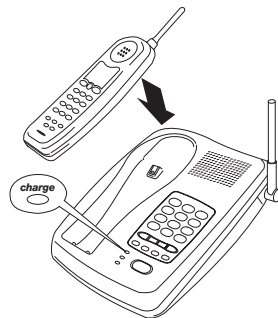

#### ▼ Low battery indicator

The low battery indicator shows when the battery pack is very low and needs to be charged. If the phone is not in use, the **batt low** LED flashes every four seconds. If the phone is in use, the **batt low** LED flashes every four seconds and the handset beeps. Complete your conversation as quickly as possible and return the handset to the base for charging.

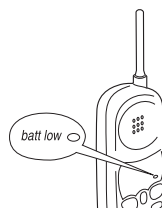

## CLEANING THE BATTERY CONTACTS

To maintain a good charge, clean all charging contacts on the handset and base about once a month. Use a pencil eraser or other contact cleaner. DO NOT use liquids or solvents; you may damage your phone.

## ADJUSTING THE VOLUME CONTROLS

### ▼ Handset ringer volume

Press the **vol** (▲) or (▼) key on the handset to set the handset ringer volume. There are two ringer volume settings; high and low.

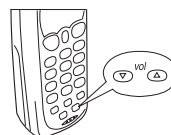

### ▼ Handset earpiece volume

There are four volume settings for the handset earpiece; max., high, low and min. **The handset earpiece volume can be adjusted only during a call.**

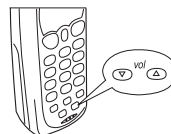

To lower the volume, press **vol** (▼). To raise the volume, press **vol** (▲).

The volume will remain on the same setting when you hang up.

## ADJUSTING RINGER TONE

1. Press **(flash)** button.
2. Press **(1)**, **(2)**, **(3)** or **(4)** on the keypad to select ringer tone.

Note: The procedure is the same for both the handset and base unit.

## INSTALLING THE BELTCLIP

### ▼ To attach the beltclip.

Insert the beltclip into the empty slot and press down until it clicks.

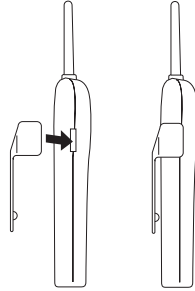

### ▼ To remove the beltclip

Pull back on the release tab and lift the beltclip up.



## AUTOMATIC DIGITAL CODE SECURITY

To prevent other parties from making unauthorised calls on your phone line, a digital code was added to the DG72. Your phone's handset and base share this code. This code is randomly set each time you place the handset in the base. If the phone experiences a power failure, you must reset the digital security code by placing the handset on the base.

### ▼ To reset the digital security code



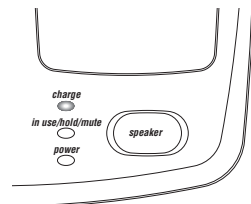

1. Restore power to the base.
2. Place the handset on the base.

**(talk)** (on the handset) and **in use/hold/mute** (on the base) LEDs momentarily blinks. The digital security code is reset.

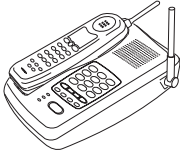

### MAKING AND RECEIVING CALLS

#### ▼ Basic phone operation

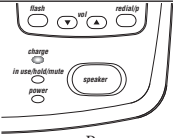
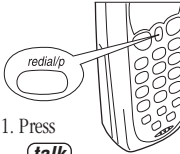
	Handset On Base	Handset Off Base	Base Only
			
<b>To answer a call</b>	Pick up handset.	 <p>Press <b>talk</b>.</p>	 <p>Press <b>speaker</b>.</p>
<b>To make a call</b>	<ol style="list-style-type: none"> <li>1. Pick up the handset.</li> <li>2. Press <b>talk</b>.</li> <li>3. Listen for the dial tone.</li> <li>4. Dial the number.</li> </ol>	<ol style="list-style-type: none"> <li>1. Press <b>talk</b>.</li> <li>2. Listen for the dial tone.</li> <li>3. Dial the number.</li> </ol>	<ol style="list-style-type: none"> <li>1. Press <b>speaker</b>.</li> <li>2. Listen for the dial tone.</li> <li>3. Dial the number.</li> </ol>
<b>To hang up</b>	Press <b>talk</b> , or return the handset to the base (AutoStandby).		Press <b>speaker</b> .
<b>To redial</b>	<ol style="list-style-type: none"> <li>1. Pick up the handset.</li> <li>2. Press <b>talk</b>.</li> <li>3. Listen for the dial tone.</li> <li>4. Press <b>redial</b>.</li> </ol> <p>Note: If any key is pressed before <b>redial</b>, the last telephone number dialed will not be redialed.</p>	 <ol style="list-style-type: none"> <li>1. Press <b>talk</b>.</li> <li>2. Listen for the dial tone.</li> <li>3. Press <b>redial</b>.</li> </ol>	<ol style="list-style-type: none"> <li>1. Press <b>speaker</b>.</li> <li>2. Listen for the dial tone.</li> <li>3. Press <b>redial</b>.</li> </ol>



The **c.wait** procedure toggles between the incoming and original call (vice versa). The **c.wait** procedure will drop the current call and pick up the incoming call or call on hold.



The **flash** + **2** call waiting procedure toggles between the incoming and original call (and visa versa).

The **flash** + **1** procedure will drop the current call connection and pick up the incoming call on hold.



In New Zealand you must subscribe to Telecom's Call Waiting Service before you can use this feature.

## CALL WAITING

### ▼ For Australian Version

#### Using the c.wait feature

Please call your local telephone service provider to check the availability of this service in your area.

1. While talking you hear the Call Waiting signal.
2. Press **c.wait** button.
3. The existing call is placed on hold.
4. Talk to the second caller.
5. Press **talk** button to end the current call.
6. The phone will ring back indicating that the first caller is still on hold.
7. Press **talk** button to answer this call.
8. Press **talk** button to end the call.

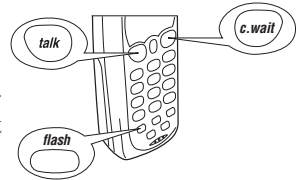

#### Using the Flash Key

To access Telstra's Call Waiting Service, you can either use the **c.wait** button or the **flash** key.

1. While talking you hear the Call Waiting signal.
2. Press **flash** then **2** to switch call and put the current call on hold.
3. To switch back to your original call, press **flash** then **1**.

### ▼ For New Zealand Version

#### Using the c.wait or flash key

1. While talking you hear the Call Waiting beep signal.
2. Press **c.wait** or the **flash** key. This feature sends a 600ms timed "hook-flash" on the telephone line for accessing services such as Call Waiting etc.

## HOLD

To use the hold feature during a conversation, press **hold**. Both parties will not be able to hear.

To disable the hold feature, press **hold** again.

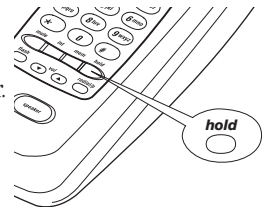



## MUTE

To use the mute feature during a conversation, press **(mute)**. The other party will not be able to hear you although you can hear them. To disable the mute feature, press **(mute)** again.

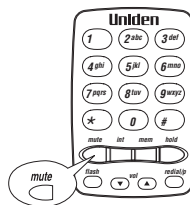

## INTERCOM

### ▼ *Intercom from the Base Unit*

1. Press **(int)** on the base unit. (If there is no answer press **(int)** again to disconnect).
2. Press **(int)** on the handset to answer the intercom.
3. Speak into the mouthpiece.
4. To turn off the intercom, press **(int)** on the base unit.

**-OR-**

Press **(int)** on the handset.

## ROOM MONITOR

You may use the **DG72** handset to monitor activity near the base unit without anyone present at the base unit.

To turn Room Monitoring on:

1. Press **(int)** on the handset.
2. There is a beep sound from the base unit then automatically two-way communications are now set up between the base unit and the handset.
3. To turn monitoring off, press **(int)** on the handset.

## CALL TRANSFER

### ▼ *Transferring a call from the Handset to the Base Unit*

When a phone call is answered at the handset, you can transfer the call to the base unit.

1. During a call, press **(int)** on the handset, the call is placed on hold automatically and the base unit is paged. (If there is no answer press **(int)** again to return to the call).

- At the base unit, press **(int)** to answer the page. An intercom link is now established between the handset and the base unit. Speak into the microphone.
- Press **(speaker)** on the base unit to establish communications between the calling party.

### ▼ **Transferring a call from the Base Unit to the Handset**

- During a call, press **(int)** on the base unit, the call is placed on hold automatically and the handset is paged. (If there is no answer press **(int)** again to return to the call on hold).
- At the handset, press **(int)** to answer the page. An intercom link is now established between base unit the and the handset. Speak into the microphone.
- Press **(talk)** on the handset to establish communications.

## STORING A PHONE NUMBER IN MEMORY

### ▼ **Entering Handset Memory Numbers**

- Remove the handset from the base.
- Press **(mem)**. The **talk** LED blinks.
- Enter the phone number, up to 16 digits. If a pause is needed during dialing to access long distance service, press **(redial/p)** to insert a pause.
- Press **(mem)** again.
- Enter the two digit memory location **(0) (1) - (2) (0)** on the keypad. A tone indicates that the number is stored.

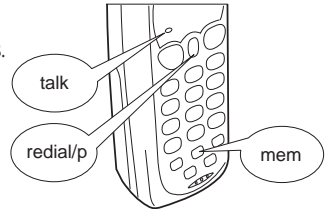

### ▼ **Entering Base Unit Memory Numbers**

- Press **(mem)**. The **in use/hold/mute** LED blinks.
- Enter the phone number, up to 16 digits. If a pause is needed during dialing to access long distance service, press **(redial/p)** to insert a pause.
- Press **(mem)** again.
- Enter the two digit memory location **(0) (1) - (2) (0)** on the keypad. A tone indicates that the number is stored.

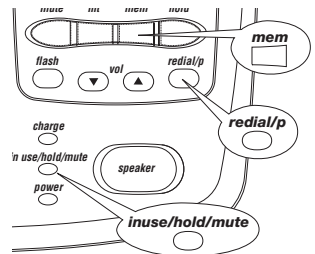

The pause button count as one digit. Pressing **(redial/p)** more than once increases the length of pause between numbers.

## DIALING A NUMBER IN MEMORY

### ▼ *Using the memory location features*

1. Press **(talk)** on handset or **(speaker)** on the base Unit
2. Press **(mem)** .
3. Enter the two digit memory location **(0 1)** - **(2 0)** .  
The number automatically dials.

## ERASING A STORED NUMBER FROM MEMORY

1. Remove the handset from the base unit.
2. Press **(mem)** button twice.
3. Press the two digit memory location **(0 1)** - **(2 0)** to be erased.  
A tone indicates that the stored number is erased from memory.

## CHAIN DIALING

On certain occasions after dialing a number, you may be requested by the party or service you are calling to enter a special access code, such as when performing a banking transaction. To store this number, refer to “Storing a Phone Number in Memory” on page 14.

### ▼ *From the Handset*

For example, if your bank’s telephone number is stored in handset memory location **(0 3)** , and your account number is stored in handset memory location **(0 4)** :

1. Press **(talk)** on the handset.
2. Press **(mem)** on the handset and number **(0 3)** on the handset keypad.
3. At the appropriate time, press **(mem)** and number **(0 4)** on the handset keypad.
4. Your handset dials the number and you may proceed with your transaction.

### ▼ **From the Base Unit**

For example, if your bank's telephone number is stored in base unit memory location **0 3**, and your account number is stored in handset memory location **0 4**:

1. Press **speaker** on the base unit.
2. Press **mem** on the base unit and number **0 3** on the base unit keypad.
3. At the appropriate time, press **mem** and number **0 4** on the base unit keypad.
4. Your base unit dials the number and you may proceed with your transaction.

## **TRAVELLING OUT-OF-RANGE**

As you begin to move too far from the base, you will first hear a clicking sound. As you travel further, the noise increases. If you travel out-of-range, your call terminates.



Check with your PABX supplier if you are not sure whether your PABX network uses Analogue or Digital interface.

## **PABX CONNECTION**

This telephone may work with a 2-wire Analogue PABX network. However, the hook-flash timing fixed at 100msec, some PABX equipment that uses a different hook flash timing may have its special feature (i.e. placing a call on hold or transferring a call) inaccessible.

## QUICK REFERENCE CHART

If your phone is not performing to your expectations, please try these simple steps first before calling Uniden customer service.

PROBLEM	SUGGESTION
<b>The charge light won't come on when the handset is placed on the base.</b>	<ul style="list-style-type: none"> <li>• Make sure the AC adaptor is plugged into the base and wall outlet.</li> <li>• Make sure the handset is properly seated in base.</li> <li>• Make sure the charging contacts on the handset and base are clean.</li> </ul>
<b>The audio sounds weak and/or scratchy</b>	<ul style="list-style-type: none"> <li>• Make sure that the base antenna is in a vertical position.</li> <li>• Move the handset and/or base to a different location away from metal objects or appliances and try again.</li> </ul>
<b>Can't make or receive calls.</b>	<ul style="list-style-type: none"> <li>• Check both ends of the base telephone line cord.</li> <li>• Make sure the AC adaptor is plugged into the base and wall outlet.</li> <li>• Disconnect the AC adaptor for a few minutes, then reconnect it.</li> <li>• Place the handset back on the charging cradle for a few seconds. The <b>(talk)</b> and <b>in use/hold/mute</b> LEDs blinks momentarily indicating that the phone has been reset.</li> </ul>
<b>The handset doesn't ring or receive a page.</b>	<ul style="list-style-type: none"> <li>• The battery pack may be weak. Charge the battery for 15-20 hours.</li> <li>• Be sure the antenna is in a vertical position.</li> <li>• The handset may be too far away from the base. Place the base away from appliances or metal objects.</li> <li>• Place the handset back on the charging cradle for a few seconds. The <b>in use</b> LED lights indicating that the phone has been reset.</li> <li>• You may have exceeded the REN limit. Disconnect some telephones.</li> </ul>

<b>PROBLEM</b>	<b>SUGGESTION</b>
<b>No dial tone.</b>	<ul style="list-style-type: none"> <li>• Check the telephone line cord connectors at both ends that they are pushed in firmly until they click.</li> <li>• If you had a power failure or had unplugged the base unit, replace the handset on the base unit for two to five second to reset the system.</li> </ul>
<b>Does not ring.</b>	<ul style="list-style-type: none"> <li>• You may have exceeded the Ringer Equivalence Number (REN) limit of how many phones can be connected to the same line. The REN total of all devices (printed on the label on the bottom of each unit) should not exceed three (3). Disconnect the appropriate units to lower the REN total.</li> </ul>
<b>No power on handset unit</b>	<ul style="list-style-type: none"> <li>• Check the battery pack connection inside the main battery compartment on the handset.</li> <li>• The handset rechargeable battery pack may need to be charged.</li> </ul>
<b>Does not charge</b>	<ul style="list-style-type: none"> <li>• Make sure the charging contacts on both the base unit and the handset are in contact during charging.</li> <li>• The charging contacts may need to be cleaned.</li> <li>• The battery pack may need to be discharged first before a full charge.</li> </ul>
<b>Range is limited</b>	<ul style="list-style-type: none"> <li>• Raise or reposition the antenna on the base or handset.</li> <li>• Move the base unit so that it is centrally located in your residence or office and make sure that the base unit is not located near appliances.</li> </ul>
<b>Calls received flutters or fades</b>	<ul style="list-style-type: none"> <li>• The handset rechargeable battery pack may need charging.</li> <li>• You may be out of normal operating range. Move closer to the base unit.</li> </ul>
<b>Cannot store or recall phone numbers from memory</b>	<ul style="list-style-type: none"> <li>• When storing phone numbers, make sure that the handset is in the standby position.</li> <li>• When recalling stored phone numbers, check first for a dial tone.</li> <li>• Always use two digits when entering/recalling memory numbers.</li> </ul>

## WARRANTY

### One Year Limited Warranty

Important: Evidence of original purchase is required for warranty service.

Warrantor: Uniden Australia Pty Limited ABN 58 001 865 498  
Uniden New Zealand Limited

**ELEMENT OF WARRANTY:** Uniden warrants to the original retail owner for the duration of this warranty, its DG72 (herein after referred to as the Product), to be free from defects in materials and craftsmanship with only the limitations or exclusions set out below.

**WARRANTY DURATION:** This warranty to the original retail owner only, shall terminate and be of no further effect 12 months after the date of original retail sale. This warranty will be deemed invalid if the product is; (A) Damaged or not maintained as reasonable and necessary, (B) Modified, altered or used as part of any conversion kits, subassemblies, or any configurations not sold by Uniden, (C) Improperly installed, (D) Repaired by someone other than an authorised Uniden Repair Agent for a defect or malfunction covered by this warranty, (E) Used in conjunction with any equipment or parts or as part of a system not manufactured by Uniden.

**PARTS COVERED:** This warranty covers for one (1) year, the Base/Charging Unit and Handset only. All accessories (AC Adaptor, Wall mount bracket etc) are covered for 90 days only.

**STATEMENT OF REMEDY:** In the event that the product does not conform to this warranty at any time while this warranty is in effect, the warrantor at its discretion, will repair the defect or replace the product and return it to you without charge for parts or service. THIS WARRANTY DOES NOT COVER OR PROVIDE FOR THE REIMBURSEMENT OR PAYMENT OF INCIDENTAL OR CONSEQUENTIAL DAMAGES. THIS GUARANTEE IS IN ADDITION TO AND DOES NOT IN ANY WAY AFFECT YOUR RIGHTS UNDER THE CONSUMER GUARANTEE ACT.

**PROCEDURE FOR OBTAINING PERFORMANCE OR WARRANTY:** In the event that the product does not conform to this warranty, the Product should be shipped or delivered, freight pre-paid, with evidence of original purchase (eg. a copy of the sales docket), to the warrantor at:

UNIDEN AUSTRALIA PTY LIMITED  
SERVICE DIVISION  
345 Princes Highway,  
Rockdale NSW 2216  
Ph (02) 9599 3355 Fx (02) 9599 3278  
Toll Free 1300 366 895

UNIDEN NEW ZEALAND LIMITED  
SERVICE DIVISION  
150 Harris Road,  
East Tamaki, Auckland  
Ph (9) 273 8383 Fx (9) 274 4253  
Toll Free 0800 4 UNIDEN  
4 864 336

Customers in other States should ship or deliver the Product freight pre-paid to their nearest Uniden Authorised Repair Centre (Contact Uniden for the nearest Warranty Agent to you)

WARRANTY

# THANK YOU

FOR PURCHASING A UNIDEN PHONE!

## Uniden

© 2002 Uniden Australia Pty Limited  
Uniden New Zealand Limited



## Free Manuals Download Website

<http://myh66.com>

<http://usermanuals.us>

<http://www.somanuals.com>

<http://www.4manuals.cc>

<http://www.manual-lib.com>

<http://www.404manual.com>

<http://www.luxmanual.com>

<http://aubethermostatmanual.com>

Golf course search by state

<http://golfingnear.com>

Email search by domain

<http://emailbydomain.com>

Auto manuals search

<http://auto.somanuals.com>

TV manuals search

<http://tv.somanuals.com>