

**Uniden®**

**DSS3455  
DSS3455+1  
DSS3455+2  
and DSS3435+1**

**Owners Manual**

**OWNER'S MANUAL**

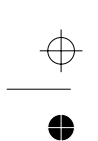

## Table of Contents

**Table of Contents** ..... 1

**Welcome**..... 4

    Terminology Used in this Manual ..... 5

**Product Overview** ..... 6

    Main Phone Features..... 6

    Answering System Features ..... 6

    Parts of the Handset ..... 7

    Parts of the Answering System Base (DSS3435)..... 8

    Parts of the Answering System/Dual-keypad Base (DSS3455)..... 9

**Using the Interface** ..... 10

    Reading the Display..... 10

    Using the Four-way Function Key ..... 11

    Using the Handset Menus..... 11

    Entering Text from Your Handset..... 12

**Installing the Phone** ..... 13

    Choosing the Best Location ..... 13

    Wall Mounting the Base ..... 13

    Installing the Battery..... 14

    Connecting the Base and Charging the Handset ..... 15

    Connecting to the Phone Line..... 15

    Testing the Connection ..... 15

    Changing the Dial Mode (Australian Model Only)..... 16

    Installing the Belt Clip..... 16

**Basic Setup**..... 17

    Setting the Day and Time ..... 17

    Activating Caller ID on Call Waiting ..... 17

    Activating Distinctive Ring..... 17

    Activating the Key Touch Tone..... 18

    Activating Name Tag (POP ID) ..... 18

    Activating the Insert 0 ..... 18

**Adding Accessory Handsets**..... 19

    Compatible Handsets ..... 19

    Charging Accessory Handsets ..... 20

    Registering Accessory Handsets..... 20

    Resetting Handsets ..... 21

**Setting Up the Phonebook** ..... 22

    Creating Phonebook Entries..... 22

    Finding a Phonebook Entry ..... 24

    Editing an Existing Phonebook Entry..... 24

    Storing Caller ID or Redial Numbers in the Phonebook..... 24

    Deleting Phonebook Entries ..... 25

    Copying Phonebook Entries to Another Handset..... 25

**Programming Base Speed Dial Numbers (Dual-keypad Base Only)** ..... 26

    Deleting Base Speed Dial Numbers ..... 27

**Customizing Your Phone**..... 27

    Changing the Handset Banner ..... 27

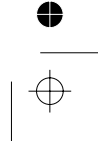
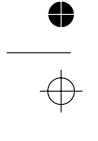
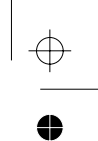

Selecting a Ring Tone (Handset Only).....	28	Answering a Transferred Call .....	38
Activating AutoTalk (Handset only) .....	29	<b>Using Special Features.....</b>	<b>38</b>
Activating Any Key Answer (Handset only) .....	29	Do Not Disturb (All Calls).....	38
<b>Using Your Phone .....</b>	<b>30</b>	Muting the Ringer (One Call Only).....	38
Keypad Lock .....	31	Muting the Microphone .....	39
Making a Call from the Phonebook.....	31	Privacy Mode.....	39
Making a Call with Handset Speed Dial .....	31	Using the DirectLink Communication Feature.....	40
Making a Call with Base Speed Dial (Dual-keypad Base Only).....	31	Using the Intercom .....	41
Switching to the Handset Speakerphone During a Call .....	31	Room/Baby Monitor.....	42
<b>Using Caller ID and Call Waiting .....</b>	<b>32</b>	Tone Dialing Switch Over (Australian Model Only) .....	43
Using the Caller ID List .....	32	Installing the Optional Headset.....	43
Making a Call from a Caller ID Record.....	32	<b>Setting Up the Answering System.....</b>	<b>44</b>
Deleting Caller ID Numbers .....	33	Features .....	44
Using Call Waiting.....	33	Using the Answering System Interface.....	45
<b>Redialing a Number.....</b>	<b>34</b>	Setting the Number of Rings.....	46
Deleting a Redial Record .....	34	Setting the Day & Time.....	47
<b>Adjusting the Ringer, Earpiece and Speaker Volume .....</b>	<b>35</b>	Recording a Personal Greeting .....	48
Adjusting the Ringer Volume.....	35	Selecting a Greeting .....	48
Adjusting the Earpiece Volume .....	35	Deleting Your Personal Greeting.....	49
Adjusting the Speaker Volume.....	35	Setting the Record Time (or Announce Only) ....	49
Adjusting the Audio Tone.....	35	Activating the Message Alert .....	50
Using the Clarity Boost Feature .....	36	Activating Call Screening.....	50
<b>Finding a Lost Handset.....</b>	<b>36</b>	Setting a Security Code or Personal Identification Number (PIN) .....	51
<b>Using Hold, Conference and Transfer .....</b>	<b>36</b>	<b>Using the Answering System.....</b>	<b>52</b>
Placing a Call on Hold.....	36	Turning Your Answering System On and Off.....	52
Conferencing.....	37		
Transferring a Call .....	37		

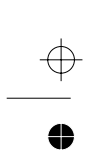

Reviewing Messages ..... 52  
Screening Calls..... 54  
Recording a Conversation..... 54  
Recording a Voice Memo..... 55  
Turning Off the Message Alert Tone ..... 55  
**Operating the Answering System While You Are  
Away from Home..... 56**  
**Maintenance..... 57**  
Specifications..... 57  
Power Failures ..... 57  
Battery Life..... 58  
Low Battery Alert..... 58  
Battery Replacement and Handling..... 58  
Change the Batteries Annually..... 59  
Clean the Battery Contacts ..... 59  
**Troubleshooting ..... 59**  
Resetting the Handset..... 59  
Resetting the Handset Without the Base..... 60

Changing the Digital Security Code..... 61  
Traveling Out of Range..... 61  
Common Issues..... 61  
Liquid Damage ..... 64  
**Index ..... 65**  
**Remote Operation Card ..... 66**  
**Warranty ..... 70**

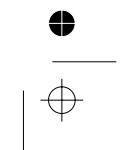
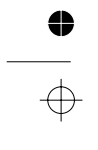
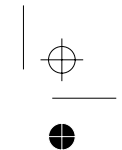

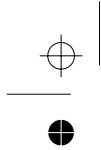

## Welcome

Thank you for purchasing a Uniden Multi-Handset phone with integrated answer machine. This unit is different from conventional cordless telephones. When the base unit is connected to AC power and a telephone line, it can support up to 4 handsets. Using extra handsets, you can establish a 3-way conference call (2 handsets and an outside line), while two other handsets are making an intercom call. You can now place a fully featured cordless handset anywhere in your home or office where AC power is available to connect the handset chargers.

**Note: Illustrations in this manual are used for explanation purposes.  
Some illustrations in this manual may differ from the actual unit.**

**Caution: The earcap of this telephone may attract and retain small metallic objects.**

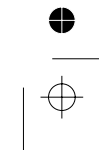
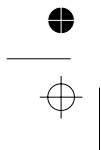

## Terminology Used in this Manual

Accessory Handset	This phone system is expandable: one base supports a total of four handsets. The accessory handset is a handset that is compatible with this model.
Base	The main part of the phone that connects to your phone line and lets you make and receive calls.
CID	Caller ID is available from your telephone provider. With this service, you can see the name and number of incoming callers
CID/CW or CIDCW	Caller ID on Call Waiting is available from your telephone provider. With this service, you can see incoming caller information while on another call. Note: Caller ID on Call Waiting is currently unavailable in NZ.
Charger	A cradle that comes with an accessory handset and charges the handset battery. It connects to power but does not connect to a phone line.

DirectLink	If you have accessory handsets on your system, you can use two handsets as 2-way radios.
Global settings	Apply to registered handsets and the base. If you change something under the global menu, you change it for all registered handsets and the base. Only one handset can change global settings at a time, and the phone must be in standby.
Standby	The handset is not in use. If it is off the cradle, no line has been activated. No dial tone is present.
Station	Any handset or the base.
Talk	A telephone line has been activated on the handset or the base, enabling a dial tone.



## Product Overview

### Main Phone Features

- 2.4GHz Digital Expandable System expands up to 4 Handsets
- Integrated Digital Answering System
- Caller ID\*
  - Caller ID on Call Waiting\*
  - Distinctive Ring\*\* by Party
  - Name Tag\*\* (POP ID) - Caller Name Identification
- Base Keypad (DSS3455 base only)
- 100 shared Phonebook Entries/Caller ID Numbers
- DirectLink Two-Way Communication
- Room/Baby Monitoring
- Speakerphones on Base & Handset
- 20 Ringer Options (10 Tones/10 Melodies)
- 10 Handset Speed Dial Numbers
- 10 Base Speed Dial Numbers (DSS3455 base only)
- Last 3 Number Redial
- Copy Phonebook Entries to Another Handset
- Call Transfer
- Conferencing
- Intercom
- Keypad Lock

\* Requires subscription to Caller ID and Caller ID on Call Waiting service provided by Network supplier. There is usually a fee for this service. The Caller ID on Call Waiting service is currently unavailable in NZ.

\*\* These features rely on the Caller ID service to function.

# Range may vary depending on environmental and/or topographical conditions.

### Answering System Features

- Digital Tapeless Recording
- Up to 12 Minutes of Recording Time
- Personal or Pre-recorded Outgoing Messages
- Day and Time Announcement
- Remote Message Retrieval
- Toll Saver
- Conversation Recording
- Voice Memo
- Message Alert
- Records Up to 59 messages

## Parts of the Handset

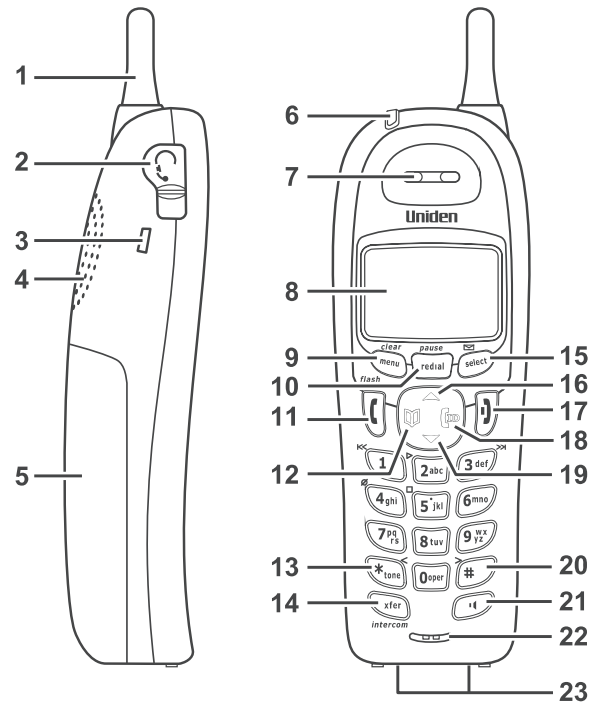

1. Handset Antenna
2. Headset Jack Cover
3. Beltclip Hole
4. Speakerphone Speaker and Ringer
5. Handset Battery Compartment
6. New Message LED
7. Handset Earpiece
8. LCD Display
9. [menu/clear] key
10. [redial/pause] key
11. [ / flash] key (talk/flash)
12. [☎] key (phonebook)
13. [\* / tone / <] key
14. [xfer/intercom] key
15. [select/✉] key (select/messages)
16. [▲] key (up)
17. [⏏] key (end call)
18. [☎] key (caller ID)
19. [▼] key (down)
20. [# / >] key (pound)
21. [🔊] key (speaker)
22. Handset Microphone
23. Handset Charging Contacts



## Parts of the Answering System Base DSS3435

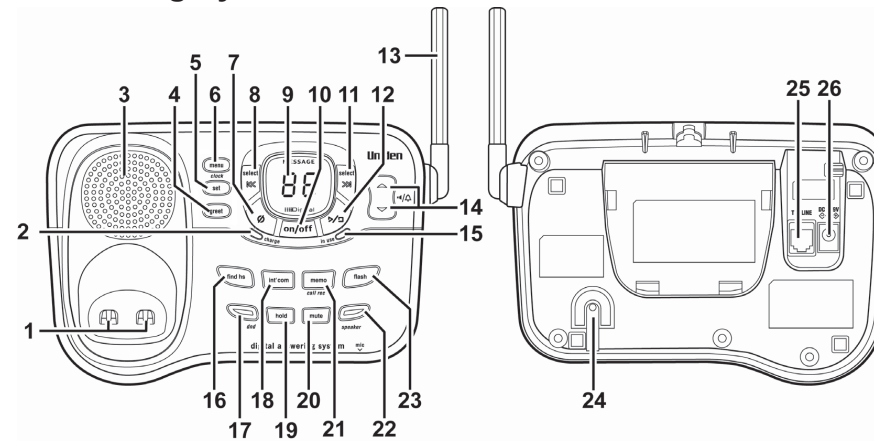

- |  |  |   |                         |
|--|--|---|-------------------------|
| 1. Base charging contacts                | 9. Message counter LED                                   | 15. <b>in use</b> LED                   | 23. <b>[flash]</b> key  |
| 2. <b>charge</b> LED                     | 10. <b>[on/off]</b> key (answering system on/off)        | 16. <b>[find hs]</b> key (find handset) | 24. Base microphone     |
| 3. Base speaker                          | 11. <b>[&gt;&gt;/select]</b> key (skip/select)           | 17. <b>[dnd]</b> key (do not disturb)   | 25. TEL LINE phone jack |
| 4. <b>[greet]</b> key (record greeting)  | 12. <b>[▶/□]</b> key (play/stop)                         | 18. <b>[int'com]</b> key (intercom)     | 26. DC IN 9V power jack |
| 5. <b>[set]</b> key                      | 13. Base antenna   | 19. <b>[hold]</b> key                   |                         |
| 6. <b>[menu/clock]</b> key               | 14. <b>[▲/▼]</b> key (volume up/down for speaker/ringer) | 20. <b>[mute]</b> key                   |                         |
| 7. <b>[∅]</b> key (delete)               |  | 21. <b>[memo/call rec]</b> key          |                         |
| 8. <b>[◀/select]</b> key (repeat/select) |  | 22. <b>[speaker]</b> key                |                         |

## Parts of the Answering System /Dual-keypad Base DSS3455

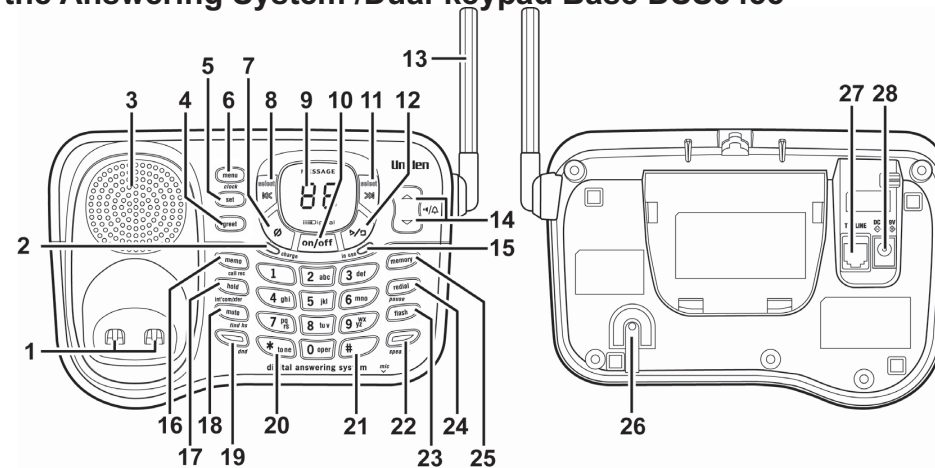







- |   |  |   |                               |
|---|--|---|-------------------------------|
| 1. Base charging contacts               | 9. Message counter LED                                   | 15. <b>in use</b> LED                                       | 22. <b>[speaker]</b> key      |
| 2. <b>charge</b> LED                    | 10. <b>[on/off]</b> key (answering system on/off)        | 16. <b>[memo/call rec]</b> key                              | 23. <b>[flash]</b> key        |
| 3. Base speaker                         | 11. <b>[&gt;&gt;]</b> key (skip/select)                  | 17. <b>[hold/int'com/xfer]</b> key (hold/intercom/transfer) | 24. <b>[redial/pause]</b> key |
| 4. <b>[greet]</b> key (record greeting) | 12. <b>[▶/□]</b> key (play/stop)                         | 18. <b>[mute/find hs]</b> key (mute/ find handset)          | 25. <b>[memory]</b> key       |
| 5. <b>[set]</b> key                     | 13. Base antenna   | 19. <b>[dnd]</b> key (do not disturb)                       | 26. Base microphone           |
| 6. <b>[menu/clock]</b> key              | 14. <b>[▲/▼]</b> key (volume up/down for speaker/ringer) | 20. <b>[*/tone]</b> key                                     | 27. TEL LINE phone jack       |
| 7. <b>[∅]</b> key (delete)              |  | 21. <b>[#]</b> key (pound)                                  | 28. DC IN 9V power jack       |
| 8. <b>[K&lt;]</b> key (repeat/select)   |  |   |                               |

## Using the Interface

### Reading the Display

The handset display uses icons to tell you the status of your phone. The table below lists the icons and what they mean.

ICON	STATUS	DESCRIPTION
	Standby/Talk	The <b>battery</b> icon indicates the handset battery status: full, medium, low, and empty.
	Standby	The <b>ringer off</b> icon indicates that the ringer is turned off.
	Talk	The <b>mute</b> icon appears when you mute the handset.
	Talk	The <b>call record</b> icon appears while recording a conversation.
	Talk	The <b>boost</b> icon appears when the Clarity Boost feature is activated.
	Talk	The <b>speaker</b> icon appears when the handset speakerphone is in use.
	Talk	The <b>privacy</b> icon appears when Privacy Mode is turned on.

## The Standby Screen

When the phone is in standby, the display shows the following items:

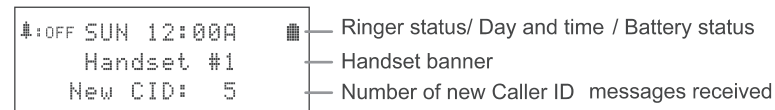

## Using the Four-way Function Key

Your handset has a four-way function key that allows you to move the cursor or pointer on the display and access the most commonly used features at the touch of a button. By moving this key to the left, you open the phonebook. Move the key to the right to access Caller ID information. To use this four-way key, place your thumb over the key on the handset and move to the four positions to get the feel of how it moves and operates.

## Using the Handset Menus

To open the menu, press **[menu/clear]**. Select the option you want by pressing the four-way function key. This will move the cursor; the option currently selected has a triangle beside it. Activate the selected option by pressing **[select/☐]**. To exit the menu and return to standby, press **[\*]**.

If you do not press a key within 30 seconds, the phone will time out and exit the menu. When setting the date and time, the time-out period is extended to two minutes.

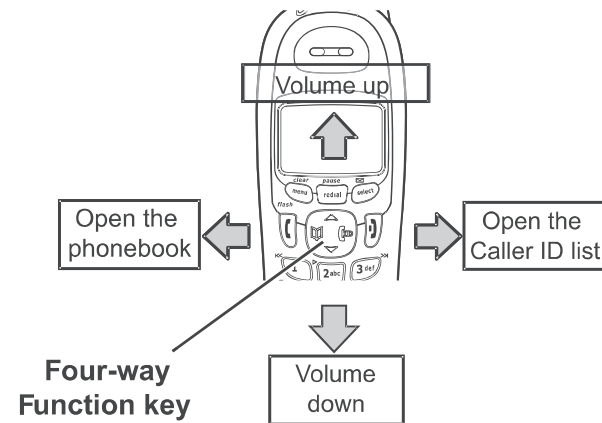

## Entering Text from Your Handset

You can use the number keypad on your phone to enter text by referring to the letters printed on each number key. When you press the number key in a text entry field, the phone displays the first letter printed on the number key. Press the number key twice to display the second letter and three times to display the third. Capital letters are displayed first, then lower case letters, then the number on the key.

If two letters in a row use the same number key, enter the first letter, then use  **[#> ]** to move the cursor to the next position to enter the second letter. For example, to enter the word "Movies":

1. Press **[6]** once to enter M.
2. Use  **[#> ]** to move the cursor to the right.
3. Press **[6]** six times to enter o.
4. Press **[8]** six times to enter v.
5. Press **[4]** six times to enter i.
6. Press **[3]** five times to enter e.
7. Press **[7]** eight times to enter s.
8. Press **[select/ ✉ ]** to end your text entry.

	Number of times key is pressed								
keys	1	2	3	4	5	6	7	8	9
<b>1</b>	1								
<b>2 abc</b>	A	B	C	a	b	c	2		
<b>3 def</b>	D	E	F	d	e	f	3		
<b>4 ghi</b>	G	H	I	g	h	i	4		
<b>5 jkl</b>	J	K	L	j	k	l	5		
<b>6 mno</b>	M	N	O	m	n	o	6		
<b>7 pqrs</b>	P	Q	R	S	P	q	r	s	7
<b>8 tuv</b>	T	U	V	t	u	v	8		
<b>9 wxyz</b>	W	X	Y	Z	w	x	y	z	9
<b>0 oper</b>	&	<	>	<	>	/	(blank)	-	-
	.	,	:	?	!	@	'	"	*
	#	0							

If you make a mistake while entering a name, use **[\*/tone/<]** or  **[#> ]** to move the cursor to the incorrect character. Press **[menu/clear]** to erase the wrong character, and then enter the correct character. To delete all characters, press and hold **[menu/clear]**.

## Installing the Phone

### Choosing the Best Location

When choosing a location for your new phone, here are some important guidelines you should consider:

- The location should be close to both a phone jack and a power outlet that is not controlled by a wall switch.
- The base and handset should be kept away from sources of electrical noise such as motors, microwave ovens, and fluorescent lighting.
- Don't place the base in direct sunlight or subject it to high temperatures. The battery may not charge properly.
- For better reception, place the base as high as possible.
- The base should be placed in an open area for optimum range and reception.
- If your home has specially wired alarm equipment connected to a phone line, be sure that installing the system does not disable your alarm equipment. If you have questions about what will disable alarm equipment, contact your telephone company or a qualified installer.

### Wall Mounting the Base

This phone can be mounted on any standard wall plate.

1. Snap the wall mount adapter into the notches on the base top.
2. Plug the AC adapter into the DC IN 9V jack.

**CAUTION: To avoid risk of fire and shock, only use the Uniden AAD-041S AC adapter.**

3. Wrap the AC adapter cord inside the molded wiring channel as shown.
4. Plug the AC adapter into a standard 240V AC wall outlet.



5. Plug the telephone line cord into the TEL LINE jack. Tuck any excess cord into the center cavity of the bracket.
6. Plug the telephone cord into the telephone jack.
7. Align the mounting slots on the base with the mounting posts on the wall. Then push in and down until the phone is firmly seated.

### Installing the Battery

Follow the steps below to install the handset battery.

1. Press in on the handset battery case cover (use the finger indentation for a better grip) and slide the cover downward to remove.
2. Place the battery pack in the battery compartment with the connectors on the battery and on the compartment aligned.
3. Place the battery case cover back on the handset and slide it upwards until it clicks into place.

**Note: Use only the Uniden BT-909 rechargeable battery pack supplied with your cordless telephone.**

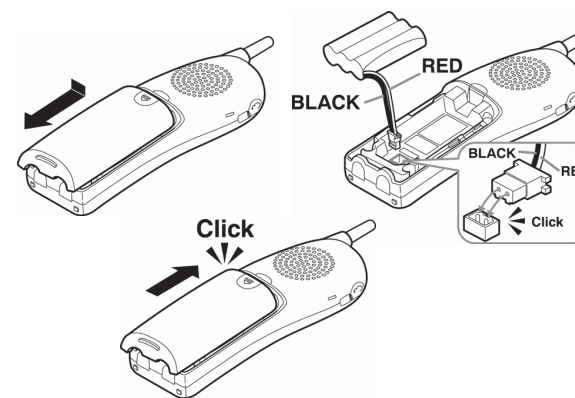
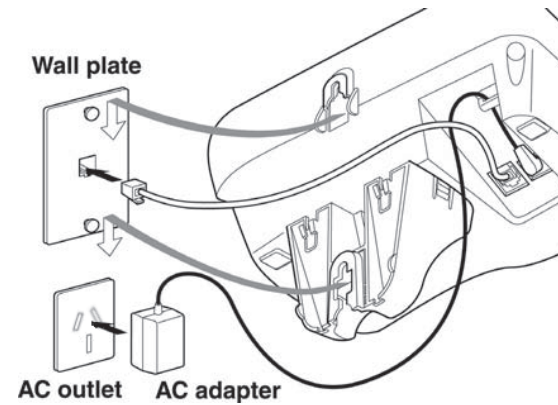

## Connecting the Base and Charging the Handset

1. Connect the AC adapter to the DC IN 9V jack.

**CAUTION: To avoid risk of fire and shock, only use the Uniden AAD-041S AC adapter.**

2. Connect the AC adapter to a standard 240V AC wall outlet.
3. Place the handset in the base with the LCD screen facing forward.
4. Make sure that the charge LED illuminates. If the LED does not illuminate, check to see that the AC adapter is plugged in and the handset makes good contact with the charging contacts.
5. Charge your handset at least 15 to 20 hours before plugging into the phone line.

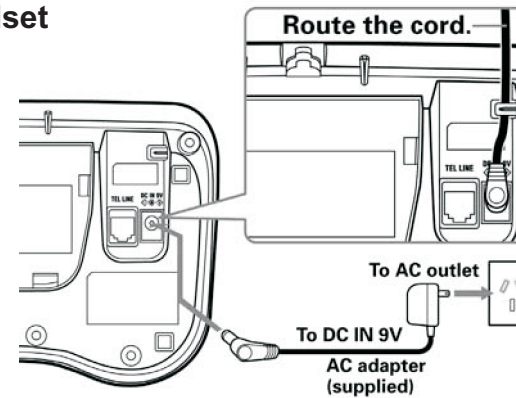

## Connecting to the Phone Line

Once the battery pack is fully charged, connect the telephone cord to the TEL LINE jack and to a telephone jack.

### High Speed Internet

If your phone line also has High Speed Internet please ensure you are using an approved line filter before connecting the telephone cord.

### Testing the Connection

Try making a call. If your call does not connect or you cannot get a dial tone, try the following steps:

1. Make sure the AC adapter cord is securely connected to the DC IN 9V jack and a standard power outlet.

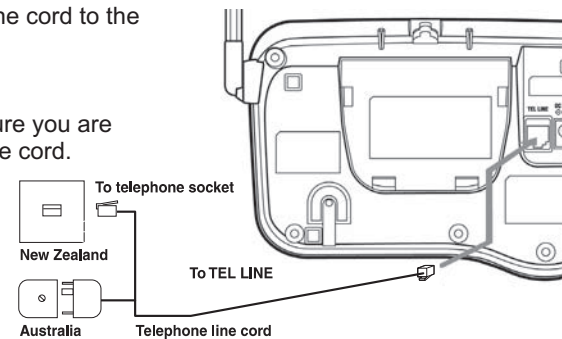

[15]



2. Check to make sure the battery is fully charged. (If you don't see the "battery full" icon, check to make sure the battery is properly connected).
3. Change the dial mode (instructions below).

### Changing the Dial Mode (Australian Model Only)

Your phone can communicate with the telephone network in two different ways: tone dialing or pulse dialing. These days, most phone networks use a method called tone dialing, so your phone comes programmed for tone dialing. If your phone company uses pulse dialing, you will need to change your phone's dial mode. If you don't get a dial tone or can't connect to the telephone network, please follow the steps below to modify your phone's settings:

1. Press **[menu/clear]**. Select the GLOBAL SETUP menu, and then the DIAL MODE submenu.
2. Scroll **[▼]** to select PULSE.
3. Press **[select/☑]**. You will hear a confirmation tone.  
If you ever need to change the dial mode back to tone dialing, follow the same procedure, but select TONE in step 2.

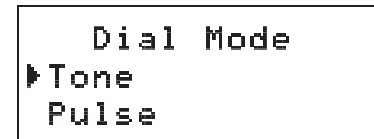

### Installing the Belt Clip

Line up the holes on each side of the handset. To attach the belt clip, insert into the holes on each side of the handset. Press down until it clicks.

**To remove the belt clip**, pull either side of the belt clip to release the tabs from the holes.

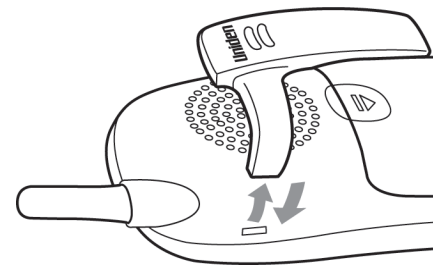

## Basic Setup

### Setting the Day and Time

To change the day and time shown in the display, follow the steps listed below.

**Note: If you don't press any keys for two minutes when setting the day and time, the phone will exit the menu.**

1. Press **[menu/clear]**. Select the GLOBAL SETUP menu, and then the DAY & TIME submenu option.
2. Move the cursor to select the day of the week, and then **[select/ ]**.
3. Move the cursor to set the hour, and then press **[select/ ]**.
4. Move the cursor to set the minute, and then press **[select/ ]**.
5. Move the cursor to choose AM or PM, and then press **[select/ ]**. You will hear a confirmation tone.

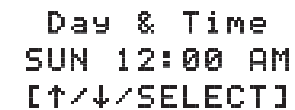

```
Day & Time
SUN 12:00 AM
[↑/↓/SELECT]
```

### Activating Caller ID on Call Waiting

Your phone supports Caller ID on Call Waiting (CIDCW), so you can see the name and number of someone who calls when you're already on the line.

The Caller ID on Call Waiting service is currently unavailable in NZ.

You'll need to subscribe to these features with your phone company before you can use them. To let your phone support these features, follow the steps below:

1. Press **[menu/clear]**. Select the GLOBAL SETUP menu, and then the CIDCW submenu.
2. Move the cursor to select CW ON or CW OFF.
3. Press **[select/ ]**. You will hear a confirmation tone.

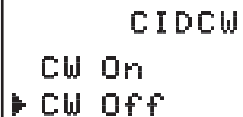

```
CIDCW
CW On
▶ CW Off
```

### Activating Distinctive Ring

You can assign special ringer tones to anyone in your phonebook. When your phone gets a call, it looks up the Caller ID information in your phonebook. If you've assigned a distinctive ringer to that number, the phone uses it so you know who is calling. To turn on distinctive ringing, follow these steps:

1. Press **[menu/clear]**. Select the HANDSET SETUP menu, and then the DISTINCT. RING submenu.
2. Move the cursor to select ON or OFF.
3. Press **[select/ ]**. You will hear a confirmation tone.

[17]

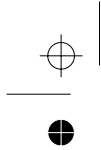

### Activating the Key Touch Tone

Key Touch Tone is the tone your keypad makes when keys are pressed. You can turn this tone on or off.

1. Press **[menu/clear]**. Select the HANDSET SETUP menu, and then the KEY TOUCH TONE submenu.
2. Move the cursor to select ON or OFF.
3. Press **[select/☑]**. You will hear a confirmation tone.

### Activating Name Tag (POP ID)

The Name Tag feature works with the Caller Display number from Caller ID. A subscription to the Caller ID service is required from your network provider. There is usually a fee for this service.

When the phone rings the received Caller Display number is compared to numbers stored in the phonebook. If there is a match then any name stored with the phonebook number will be displayed.

To turn Name Tag on or off, follow the steps below:

1. Press **[menu/clear]**. Select the GLOBAL SETUP menu, and then the NAME TAGGING submenu.
2. Move the cursor to select On or Off.
3. Press **[select/☑]**. You will hear a confirmation tone.

### Activating the Insert 0

This feature adds '0' or '00' to the number, when you receive Caller ID messages. The default setting for New Zealand is On. The default setting for Australia is Off.

To turn Insert 0 on or off, follow the steps below:

1. Press **[menu/clear]**. Select the GLOBAL SETUP menu, and then the INSERT 0 submenu.
2. Move the cursor to select On or Off.
3. Press **[select/☑]**. You will hear a confirmation tone.

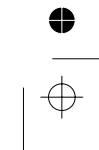
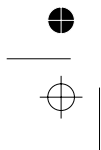

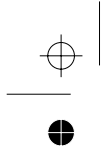

### **Adding Accessory Handsets**

Your phone supports up to four handsets, including any handsets supplied with your phone. accessory handsets do not need to be connected to a phone jack. You can now place a fully-featured cordless handset anywhere AC power is available to connect the handset charger. All the handsets ring when a call is received.

### **Compatible Handsets**

Your phone is compatible with the DSS3405 additional handset. If you purchase an accessory handset, you must register the handset to the base before use. Accessory handsets will not operate until they are registered.



**DSS3405**

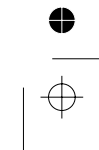
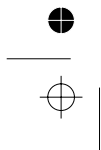

## Charging Accessory Handsets

The handset is powered by a rechargeable battery pack. The battery recharges automatically when the handset is placed in the charger.

1. Connect the AC adapter to the DC IN 9V jack and to a 240V AC outlet that is not controlled by a wall switch.

**Caution: Use only the Uniden AAD-600S adapter.**

2. Set the charger on a desk or tabletop, and place the handset in the charger with the keypad facing forward.
3. Make sure that the charge LED illuminates. If the LED does not illuminate, check to see that the AC adapter is plugged in and the handset makes good contact with the base charging contacts.
4. Charge the handset battery pack for at least 15-20 hours before using your new cordless telephone for the first time.

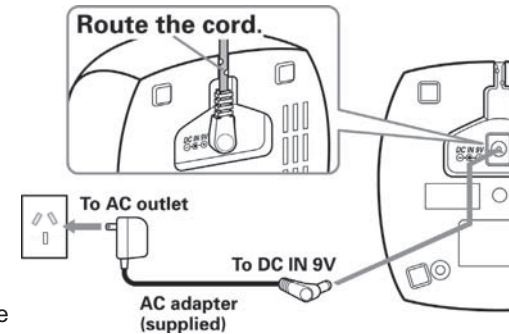

## Registering Accessory Handsets

If you purchase an accessory handset, you need to register the handset before use. Only one handset can be registered at a time. Handsets supplied with the phone are registered to the base by the factory. When charged, pre-registered handsets display a handset ID number. Handsets that have not been registered display MODELS VARY! CHARGE HANDSET ON THE BASE FOR REGISTRATION OR REFER TO OWNER'S MANUAL. (If an accessory handset has ever been registered to a base, you must reset the handset before you can register it to a new base. See *Resetting Handsets* on page 21.)

When you register an accessory handset to the base, the handset ID will be assigned.

**Note: Before registering any accessory handsets, make sure the accessory handset's battery is fully charged.**

## Registering DSS3405 Handsets

To register DSS3405 handsets, simply place the accessory handset in the base. While the handset is registering, HANDSET REGISTERING will appear in the LCD. When REGISTRATION COMPLETE is displayed, the handset has been registered to the base. If REGISTRATION FAILED appears, remove the handset from the base and try again.

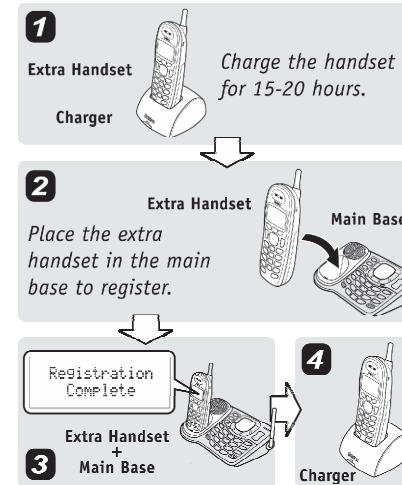

## Resetting Handsets

If you want to register the handset to a different base or replace a handset with another one, you must first clear the registration information from the base and the handset.

1. Press and hold [∗] and [#>] for at least 5 seconds, until the SYSTEM RESET menu appears.
2. Select the DEREGISTER HS submenu. WHICH HANDSET? appears in the display.
3. Use [▲] and [▼] to select the handset ID you want to de-register, and then press [select/☐]. DEREGISTER HS appears.
4. When the phone asks you to confirm, move the cursor to select YES, and then press [select/☐]. You will hear a confirmation tone.

```
Which Handset?
▶ Handset #1
  Handset #2
```

**Note:** The handset first clears its registration information from the base and then deletes the link to the base from its own memory. The handset will now display **MODELS VARY! CHARGE HANDSET ON THE BASE FOR REGISTRATION OR REFER TO OWNER'S MANUAL**. If the handset cannot contact the base, it will display **OUT OF RANGE**. If this happens, see *Resetting the Handset Without the Base* on page 60. For instructions on registering the handset, see page 20.



### Setting Up the Phonebook

Your handset can store up to 100 names and numbers in your phonebook. Your phone shares memory between your phonebook and Caller ID entries. Once you store 100 phonebook entries, Caller ID information will not be stored and will only display at time of new incoming call. When all the phonebook entries are full, you will hear a beep and **MEMORY FULL** appears. You cannot store any additional names and numbers unless you delete some of the existing ones.

You can also use the phonebook entries or speed dial memory to store a group of numbers (up to 20 digits) that you may need to enter once your call connects. This is referred to as chain dialing.

### Creating Phonebook Entries

To store names and numbers in your phonebook, please follow these steps:

1. When the phone is in standby mode, press [  ].
2. To create a new phonebook entry, move the cursor to select **STORE NEW**, and press [ **select** /  ]. **STORE/EDIT NAME** appears.
3. Enter the name for this entry (**STORE/EDIT NAME**).

Use the keypad to enter a name for this entry; the name can contain up to 16 characters. (See *Entering Text from Your Handset* on page 12 for instructions on entering text.) If you do not want to enter a name for this entry, your phone will store this entry as **<NO NAME>**. Press [ **select** /  ] when you are finished.



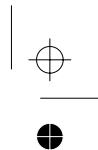
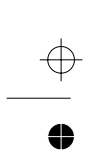

4. Enter the number for this entry (STORE/EDIT NO.).

Once you have stored a name, STORE/EDIT NO. appears next. Use the number keypad to enter the phone number; the phone number can contain up to 20 digits. If you need the phone to pause between digits when it's dialing (for example, to enter an extension or an access code), press **[redial/pause]** to insert a two-second pause. You will see a P in the display. You can also use more than one pause together if two seconds is not long enough. Each pause counts as one digit.

```
Store/Edit No.  
8007303456■
```

5. Assign a distinctive ring tone for this entry (DISTINCTIVE RING).

You can attach a special ring tone to each phonebook entry; the phone will use this ring tone when this person calls. Use **[▲]** and **[▼]** to select one of the 20 different ring tone options (see *Selecting a Ring Tone (Handset Only)* on page 28 for a complete list of ring tones). As you scroll through the tones, you will hear a sample of each tone. When you hear the ring tone you want to use, press **[select/☐]**. If you do not want to use a distinctive ring tone for this phonebook entry, choose NO SELECTN; the phone will use your standard ring tone setting.

```
Distinctive Ring  
▶No Selectn  
Flicker
```

6. Assign this entry to a Speed Dial number (SPEED DIAL).

Your handset has 10 speed dial numbers, **[0]** to **[9]**. Use **[▲]** and **[▼]** to select the speed dial number you want to assign to this phonebook entry, and press **[select/☐]**. Choose NO SELECTN if you do not want to assign this entry to a speed dial number. If the speed dial number is already assigned to a phonebook entry, your phone will overwrite the assigned speed dial information.

```
Speed Dial  
▶No Selectn  
SPD1:<Empty>
```

7. You will hear a tone confirming that the new entry has been stored, and DONE! appears in the display.

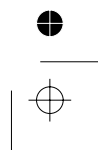
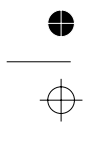





## Finding a Phonebook Entry

Press [ ] to open the phonebook, and then select DIAL/EDIT. Phonebook entries are stored in alphabetical order. To scroll through the phonebook from A to Z, press [▼]. To scroll through the phonebook from Z to A press [▲]. You can also use the letters on the number keys to jump to a name that starts with that letter. Press a number key ([2] through [0]) once for the first letter, twice for the second letter, and so on. The phonebook jumps to the first entry that begins with the letter you entered; you can then use [▲] and [▼] to scroll to other entries. For example, to search for an entry beginning with the letter M, press 6 once.

To close the phonebook, press [ ]. During a call, press [ ] again instead of [ ] to close the phonebook.

## Editing an Existing Phonebook Entry

1. With the phone in standby, press [ ] to open the phonebook.
2. Select DIAL/EDIT.
3. Find the entry you want to edit and press [select/ ] .
4. Follow the steps for *Creating Phonebook Entries* on page 22. If you do not wish to change the information at any step, simply press [select/ ] to go to the next step.

## Storing Caller ID or Redial Numbers in the Phonebook

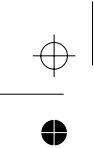
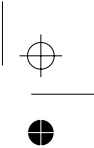

You can store Caller ID records or redial numbers in the phonebook so you can use them later. Go to the Caller ID or redial list and select the number you want to store. (If the Caller ID information did not include the number, then you will not be able to store it.)

1. When the phone is in standby, press [ ] to open the Caller ID list or [redial/pause] to open the redial list.
2. Use [▲] and [▼] to scroll through the Caller ID records or redial numbers. When you come to the information you want to store, press [select/ ] . STORE/EDIT NAME appears.

- 
- 
3. If the phone number is already stored in memory, you will hear a beep, and THIS DATA IS ALREADY STORED!! appears in the display. The number will not be stored. Continue by following the steps for *Creating Phonebook Entries* on page 22.

### Deleting Phonebook Entries



You can delete individual phonebook entries or delete all the phonebook entries at once.

1. When the phone is in standby, press [  ].
2. To delete a single phonebook entry, move the cursor to select DIAL/EDIT, and then press [select/  ].
3. Find the phonebook entry you want to delete and press [menu/clear].
4. DELETE MEMORY? appears in the display. Select YES, and then press [select/  ].
5. You will hear a confirmation tone, and DELETED! appears in the display.



```
Phonebook : 50
Copy
Delete All
```

#### Deleting all the phonebook entries at once

1. When the phone is in standby, press [  ].
2. Move the cursor to select DELETE ALL, and press [select/  ].
3. DELETE ALL? appears in the display. Select YES and then press [select/  ]. You will hear a confirmation tone, and DELETED! appears in the display.

### Copying Phonebook Entries to Another Handset

If you have more than one handset, you can transfer phonebook entries from one handset to another without having to re-enter names and numbers. You can transfer one phonebook entry at a time or all phonebook entries at once.

1. When the phone is in standby, press [  ].

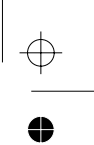
- 
- 
2. Move the cursor to select COPY, and then press **[select/ ☒]** .
  3. Move the cursor to select the handset which you want to transfer the entries to and then press **[select/ ☒]** .
  4. Move the cursor to select ONE MEMORY or ALL MEMORY, and then press **[select/ ☒]** .
  5. If you select ALL MEMORY, ARE YOU SURE? appears on the display screen. Move the cursor to select YES, and then press **[select/ ☒]** .
  6. If you select ONE MEMORY, find the phonebook entry you want to transfer and then press **[select/ ☒]** .
  7. The phonebook entries will be transferred to the designated handset. During the copy process, the receiving handset shows RECEIVING and the banner of the sending handset.
  8. When the transfer is completed, DONE! appears on the handset.



```
Copy Phonebook
▶One Memory
All Memory :xxx
```

**Note: If your phonebook contains 100 entries, you cannot store any new phonebook entries. You will hear a beep, and MEMORY FULL appears on the display. If the selected handset is out of range or data transfer is canceled, UNAVAILABLE appears in the display. Phonebook listings will not be transferred.**

### Programming Base Speed Dial Numbers (Dual-keypad Base Only)

The dual keypad base can store 10 speed dial numbers, [0] to [9]. Follow the steps below to store new speed dial numbers in the base. (Handset speed dial numbers are stored as part of a phonebook entry. See *Creating Phonebook Entries* on page 22 for information on programming handset speed dial numbers.)

1. With the phone in standby, press **[memory]**.
2. Use the number keypad to enter the phone number; the phone number can contain up to 20 digits. If you need the phone to pause between digits when it's dialing (for example, to enter an extension or an access code),

- press **[redial/pause]** to insert a two-second pause. You can also use more than one pause together if two seconds is not long enough. Each pause counts as one digit.
3. Press **[memory]** again, and then press the number key (**[0]** to **[9]**) where you want to store this phone number. You will hear a confirmation tone.

### Deleting Base Speed Dial Numbers

1. With the phone in standby, press **[memory]** twice.
2. Press the number key (**[0]** to **[9]**) that contains the phone number you want to delete. You will hear a confirmation tone.

## Customizing Your Phone

### Changing the Handset Banner

Each handset will display a banner name once it is registered to the base. The default banner is Handset #1, Handset #2, etc. You can change the name your phone displays by changing the banner display. If you have more than one handset, the banner name identifies your handset during handset-to-handset functions like intercom and DirectLink communication. The name will be displayed on the LCD screen during Standby, Intercom, Intercom Hold, Room/Baby Monitor, and Copy Phonebook operations. The banner name will be displayed on the receiving handset as well.

1. Press **[menu/clear]**.
2. Select the HANDSET SETUP menu, and then the BANNER submenu.
3. Use the keypad to enter or edit the banner name. (See *Entering Text from Your Handset* on page 12 for detailed instructions on entering text.)
4. Press **[select/☑ ]**. You will hear a confirmation tone.



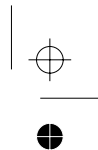
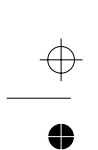

## Selecting a Ring Tone (Handset Only)

You may choose from 10 melodies or 10 tones for your phone's primary ring tone. Each station can use a different ringer tone or melody. The available ring tones are listed below:

### Melodies

Beethoven's Symphony #9 (BEETHOVEN9)  
For Elise (ELISE)  
We Wish You A Merry Christmas (MERRY- XMAS)  
Home Sweet Home (HM SWT HM)  
Lorri Song #6 (LORRI SONG)

When Irish Eyes Are Smiling (IRISH EYES)  
Aura Lee (AURA LEE)  
Let Me Call You Sweet Heart (SWEETHEART)  
Waltzing Matilda (W MATILDA)  
Old MacDonald (OLD MACDLD)

### Ringers

Flicker  
Soft Alert  
Light Bug  
Tone Board  
Party Clap

Clatter  
Wake Up  
Beep Boop  
Chip Chop  
Reminder

1. Press **[menu/clear]**. Select the HANDSET SETUP menu, and then the RINGER TONES submenu.
2. Move the cursor to select a ring tone. As each ring tone is selected, you will hear a sample of the ring tone.
3. When you hear the tone you want to use, press **[select/ ]**. You will hear a confirmation tone.

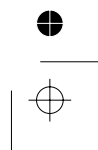
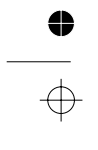
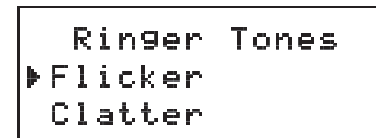

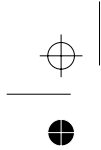

### Activating AutoTalk (Handset only)

AutoTalk allows you to answer the phone simply by removing the handset from the cradle. You do not have to press any keys to answer the call.

1. Press **[menu/clear]**.
2. Select the HANDSET SETUP menu, and then the AUTOTALK submenu.
3. Select ON or OFF, and press **[select/☑]** . You will hear a confirmation tone.



### Activating Any Key Answer (Handset only)

Any Key Answer allows you to answer the phone by pressing any key in the twelve-key pad.

1. Press **[menu/clear]**.
2. Select the HANDSET SETUP menu, and then the ANY KEY ANSWER submenu.
3. Select ON or OFF, and then press **[select/☑]** . You will hear a confirmation tone.

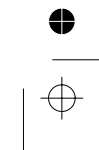
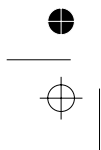
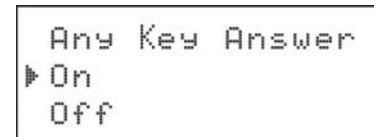

## Using Your Phone

	From a cordless handset	From a handset speaker phone	From the base speaker phone
<b>Making a call</b>	<ol style="list-style-type: none"> <li>1. Remove the handset from the charging cradle.</li> <li>2. Press [ <b>[ / flash]</b> .</li> <li>3. Listen for the dial tone.</li> <li>4. Dial the number.</li> </ol> <p><b>OR</b></p> <ol style="list-style-type: none"> <li>1. Remove the handset from the charging cradle.</li> <li>2. Dial the number.</li> <li>3. Press [ <b>[ / flash]</b> .</li> </ol>	<ol style="list-style-type: none"> <li>1. Remove the handset from the charging cradle.</li> <li>2. Press [ <b>[ / flash]</b> .</li> <li>3. Listen for the dial tone.</li> <li>4. Dial the number.</li> </ol> <p><b>OR</b></p> <ol style="list-style-type: none"> <li>1. Remove the handset from the charging cradle.</li> <li>2. Dial the number.</li> <li>3. Press [ <b>[ / flash]</b> .</li> </ol>	<p><b>(Dual Keypad Model Only)</b></p> <ol style="list-style-type: none"> <li>1. Press [ <b>speaker</b> ] .</li> <li>2. Listen for the dial tone.</li> <li>3. Dial the number.</li> </ol>
<b>Answering a call</b>	<ol style="list-style-type: none"> <li>1. Pick up the handset. (If AutoTalk is on, the phone will answer when you remove the handset from the charging cradle.)</li> <li>2. Press [ <b>[ / flash]</b> . (If Any Key Answer is on, you can also press any key on the twelve-number keypad.)</li> </ol>	<ol style="list-style-type: none"> <li>1. Pick up the handset. (If AutoTalk is on, the phone will answer when you remove the handset from the charging cradle.)</li> <li>2. Press [ <b>[ / flash]</b> .</li> </ol>	Press [ <b>speaker</b> ] .
<b>Hanging up</b>	Press [ <b>[ / flash]</b> ] or return the handset to the cradle.	Press [ <b>[ / flash]</b> ] or return the handset to the cradle.	Press [ <b>speaker</b> ] .



## Keypad Lock

Use Keypad Lock to disable key response. You can still answer calls, receive page and receive copy phonebook locations - keylock will reactivate after these operations.

### To lock the keypad

Press and hold [\* /tone /<] until you hear a confirmation tone. KEYPAD LOCKED appears.

If any key is pressed when keypad is locked, TO UNLOCK KEYPAD PRESS & HOLD \*KEY appears.

### To unlock the keypad

Press and hold [\* /tone /<] again. KEYPAD UNLOCKED appears.

## Making a Call from the Phonebook

1. When the phone is in standby, press [ ] to open the phonebook.
2. Move the cursor to select DIAL/EDIT, and then press [select/ ] .
3. Find the phonebook entry you want to call (see *Finding a Phonebook Entry* on page 24).
4. Press [ / flash] or [ ] to dial the number.

**Note:** You can also press [ / flash] or [ ] before you open the phonebook. When you come to the phone number you want to dial, press [select/ ] .

## Making a Call with Handset Speed Dial

1. When the phone is in standby, press and hold one of the number keys ([0] through [9]) until the assigned phonebook entry appears in the display.
2. Press [ / flash] or [ ] to dial the number.

## Making a Call with Base Speed Dial (Dual-keypad Base Only)

1. When the phone is in standby, press [speaker].
2. Press [memory].
3. Press the number key ([0] through [9]) where the desired phone number is stored. The phone dials the programmed number.

## Switching to the Handset Speakerphone During a Call

To switch a normal call to the speakerphone, press [ ] on the handset. To switch from a speakerphone call to a normal call, press [ ] .



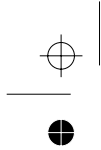

## Using Caller ID and Call Waiting

If you subscribe to Caller ID from your phone company, your phone will show you the caller's phone number and name (if available) whenever a call comes in. If you subscribe to both Call Waiting and Caller ID, the phone also shows you the name and the number of any call that comes in while you're on the line.

## Using the Caller ID List

You can store up to 100 Caller ID numbers in each handset. Your phone shares memory between your phonebook and Caller ID entries. Once you reach your maximum phonebook entries of 100, Caller ID information will not be stored (but it will still display when the call comes in).

To open the Caller ID list, press **[CID]** (on the right side of the four-way key). The phone will show the total number of stored Caller ID records. Use **[▲]** and **[▼]** to scroll through the list, or enter a letter on the keypad to jump to the first Caller ID name that starts with that letter.

## Making a Call from a Caller ID Record

1. When the phone is in standby, press **[CID]** to open the Caller ID list.
2. Use **[▲]** and **[▼]** to find the Caller ID record you want to dial.
3. Press **[\* / flash]** or **[#]** to dial the number.

**Note:** You can also press **[\* / flash]** or **[#]** before you open the Caller ID list. When you come to the phone number you want to dial, press **[select/☐]**.

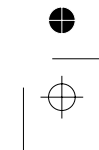
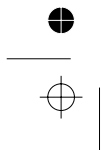

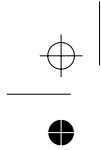

## Deleting Caller ID Numbers

To delete only one Caller ID number, go to the Caller ID list and select the number you want to delete. Press **[menu/clear]**. When the phone asks you to confirm, select YES.

To delete all the Caller ID numbers, press **[\*]** and then **[menu/clear]**. Select YES when asked if you want to Delete all. When you delete a Caller ID number, you delete it permanently.

## Using Call Waiting

If you have Call Waiting service and a second call comes in when you are on the phone, a call waiting tone will sound.

**For Australian model:** Press **[ /flash]** and then **2** on the handset or **[flash]** and then **2** on the base to switch between callers. There is a short pause during the switch.

**For New Zealand model:** Press **[ /flash]** on the handset or **[flash]** on the base to switch between callers. There is a short pause during the switch.

**Note: You must subscribe through your telephone provider to receive Call Waiting services. Not all features are available in all areas.**

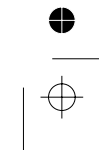
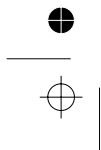

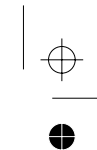
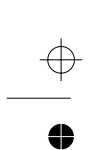

## Redialing a Number

You can quickly redial the last 3 numbers dialed on each handset or the last number dialed on the dual-keypad base.

From the dual-keypad base	From the handset
<ol style="list-style-type: none"><li>1. Press <b>[speaker]</b>.</li><li>2. Then press <b>[redial/pause]</b>.</li></ol>	<ol style="list-style-type: none"><li>1. With the phone in standby, press <b>[redial/pause]</b> to open the redial list.</li><li>2. Use <b>[redial/pause]</b> or <b>[▲]</b> and <b>[▼]</b> to scroll through the redial list.</li><li>3. When you find the number you want to dial, press <b>[ / flash]</b> or <b>[⏏]</b>.</li></ol>

**Note:** You can also redial the last number dialed on the handset by pressing **[ / flash]** or **[⏏]**, and then **[redial/pause]**.

## Deleting a Redial Record

If you want to delete a phone number from the handset's redial list, follow the steps below:

1. With the phone in standby, press **[redial/pause]**.
2. Use **[redial/pause]** or **[▲]** and **[▼]** to scroll through the redial list.
3. When you find the redial number you want to delete, press **[menu/clear]**.
4. Select YES, and then press **[select/✉]** or **[menu/clear]**. The redial number is deleted.

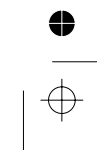
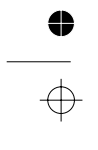

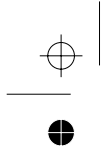

## Adjusting the Ringer, Earpiece and Speaker Volume

### Adjusting the Ringer Volume

You can choose from three ringer volume settings on the handset (off, low, and high) and four options (off, low, medium, and high) on the base. With the phone in standby, use [▲] or [▼] to adjust the ringer volume.

### Adjusting the Earpiece Volume

You can choose from six volume levels for the earpiece. To adjust the earpiece volume while on a call, press [▲] (to make it louder) or [▼] (to make it softer).

### Adjusting the Speaker Volume

**Handset Speakerphone:** You can choose from six volume levels for the handset speakerphone. To adjust the speaker volume while on a call, press [▲] (to make it louder) or [▼] (to make it softer).

**Base Speakerphone:** You can choose from ten volume levels for the base speakerphone. To adjust the speaker volume while on a call, press [▲] (to make it louder) or [▼] (to make it softer).

### Adjusting the Audio Tone

If you aren't satisfied with the audio quality of your phone, you can adjust the Audio Tone of the earpiece while on a call. Your phone gives you three audio tone options: low, natural and high; the default setting, Natural Tone, is recommended for hearing aid users. Audio tone adjustments only apply to the earpiece, not the speakerphone.

To adjust the audio tone:

1. With the handset in talk mode, press [select/✉] to cycle through the three audio tone options.
2. When the desired option appears on the display, stop.
3. After two seconds, the displayed audio tone is set, and the display returns to normal.

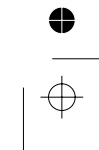
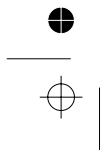

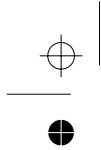

## Using the Clarity Boost Feature

If you encounter interference while using your handset, you can manually improve the sound by setting the clarity booster to on. This works only when the handset is in use, so while you are on a call:

1. Press **[menu/clear]**.
2. Move the cursor to CLARITY BOOST, and then press **[select/☐]**. BOOST ON and B appear in the display. Use the same procedure to turn off clarity booster. BOOST OFF appears.

## Finding a Lost Handset

To locate a misplaced handset, press **[find hs]** on the base (or **[mute/find hs]** on the dual-keypad base) when the phone is in standby. All registered handsets will beep for 60 seconds, and PAGING appears on the handset display. To cancel paging, press **[find hs]** (**[mute/find hs]**) again or any key on the found handset.

## Using Hold, Conference and Transfer

### Placing a Call on Hold

To place a caller on hold, press **[xfer/intercom]** on the handset, **[hold]** on the base, or **[hold/int'com/xfer]** on the dual-keypad base. If you leave a caller on hold for more than ten seconds, the display will read, LINE ON HOLD. To return to the party on hold, press **[ / flash]** or **[⏏]** on a handset or **[speaker]** on the base.

**Note: You can only place a caller on hold for 5 minutes. Once 5 minutes have passed, the caller will be disconnected and the phone will return to standby. While a call is on hold, Caller ID and Call Waiting can not be received.**

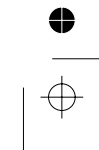
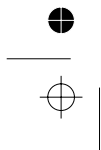

## Conferencing

If you have more than one handset, up to four people can participate in a conference call. A three-way conference call consists of an outside line and two stations. A four-way conference call consists of an outside line, the base speaker phone, and two handsets. You can easily join a call already in progress.

From the handset, press [**Ⓛ** / **flash**] or [**Ⓛ**] to join the call. From the base, press [**speaker**]. You can hang up normally; the other station will still be connected to the call.

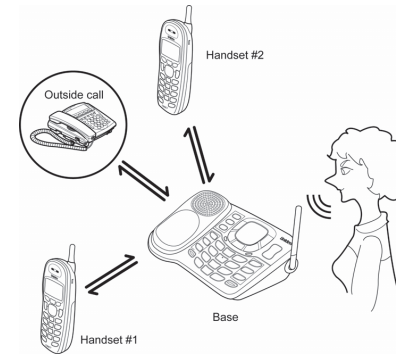

## Transferring a Call

You can transfer a call from one station to another.

From the base	From the handset
<ol style="list-style-type: none"><li>1. During a call, press [<b>int'com</b>] (<b>[hold/int'com/xfer]</b> on the dual-keypad base).</li><li>2. The call will automatically be placed on hold, and a paging tone sounds on all stations. (On the dual-keypad base, you need to select the handset you want to talk with by pressing [<b>1</b>] through [<b>4</b>], or press [<b>*/tone</b>] to page all registered handsets.) To cancel the transfer, press [<b>speaker</b>] or [<b>int'com</b>] (<b>[hold/int'com/xfer]</b>).</li><li>3. When another station accepts the transferred call, you will be disconnected. If you want to rejoin the call, press [<b>speaker</b>] again.</li></ol>	<ol style="list-style-type: none"><li>1. During a call, press [<b>xfer/intercom</b>].</li><li>2. Use [<b>▲</b>] or [<b>▼</b>] to select the station you want to transfer the call to, then press [<b>select/☐</b>]. The call will automatically be placed on hold, and a paging tone sounds. To cancel the transfer, press [<b>Ⓛ</b> / <b>flash</b>] or [<b>Ⓛ</b>].</li><li>3. When another station accepts the transferred call, you will be disconnected. If you want to rejoin the call, press [<b>Ⓛ</b> / <b>flash</b>] again or [<b>Ⓛ</b>].</li></ol>

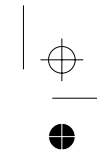
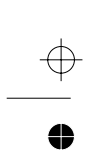

## Answering a Transferred Call

When a station receives a call transfer, it sounds a paging tone; handsets also show the ID of the station that is paging. To accept the call transfer:

1. To answer the page and speak to the transferring station, press [**1** / **flash**] or [**xfer/intercom**] on the handset. On the base, press [**speaker**] or [**int'com**] ([**hold/int'com/xfer**] on the dual-keypad base).
  2. To accept the call and speak to the caller, press [**1** / **flash**] on the handset or [**speaker**] on the base.
  3. When you accept the transferred call, the transferring station will be disconnected.
- Only the first station to answer the transfer page will be connected to the call. If the transfer page is not picked up within one minute, the operation will be canceled.

## Using Special Features

### Do Not Disturb (All Calls)

Do not disturb (DND) allows you to mute the ringer of all stations at once. With the phone in standby, press and hold [**dnd**] on the base. You will hear a confirmation tone and the dnd LED illuminates. To cancel, press [**dnd**] again. You can also mute the ringer tone while the phone is ringing by pressing [**dnd**] on the base.

**Note: If the answering system is off, it will automatically turn on when you activate DND. If you turn the answering system off while DND is on, DND automatically turns off along with the answering system.**

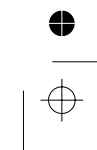
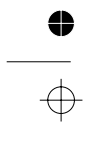

### Muting the Ringer (One Call Only)

While the phone is ringing, press [**1**] on the handset or [**▷/□**] on the base to mute the ringer for this call. The phone will ring again on the next call. (The handset must be off the cradle to mute the ringer.)



## Muting the Microphone

Mute turns off the microphone so the caller can't hear you. This only works while you are on a call.

From the base	From the handset
<ol style="list-style-type: none"><li>1. Press <b>[mute]</b> (<b>[mute/find hs]</b> on the dual-keypad base). The speaker LED blinks while muting is on.</li><li>2. To cancel muting, press <b>[mute]</b> or <b>[mute/find hs]</b> again. The speaker LED stops blinking.</li></ol>	<ol style="list-style-type: none"><li>1. Press <b>[menu/clear]</b>.</li><li>2. Move the cursor to select MUTE and then press <b>[select/ ]</b>. MUTE ON and  appear in the display;  remains while muting is on.</li><li>3. To cancel muting, repeat the procedure, MUTE OFF appears.</li></ol>

## Privacy Mode

If you don't want other stations to interrupt your call, turn on privacy mode. As long as your handset is in privacy mode, other stations can't join your call or make any calls of their own: their displays will show UNAVAILABLE.

1. While on a call, press **[menu/clear]**.
2. Move the cursor to PRIVACY MODE, and then press **[select/ ]**. PRIVACY MODE ON and P appear in the display for 2 seconds; the icon remains in the display as long as privacy mode is on.

To turn privacy mode off, repeat the procedure listed above.



## Using the DirectLink Communication Feature

Using the DirectLink two-way communication feature, a pair of handsets can function as two-way radios. DirectLink communication does not interfere with the base's ability to make or receive telephone calls. You must set both handsets to use DirectLink communication before they can call each other. Other handsets can be used while two handsets are using DirectLink communication; however, the two handsets using DirectLink communication are not able to make or receive calls until the operation is canceled.

1. Press **[menu/clear]** and move the cursor to the DIRECTLINK MODE menu.
2. Press **[select/ ]**. The display shows TO ENTER DIRECTLINK MODE PRESS [SELECT].
3. Press **[select/ ]**. You will hear a confirmation tone, and DIRECTLINK MODE COMPLETE appears in the display.

```
To enter
DirectLink mode
press [SELECT]
```

## Making a DirectLink Call

1. To call another handset with DirectLink communication, press **[ / flash]**. The display shows TO DIRECTLINK A HANDSET PRESS [1-4].
2. Press the number of the handset you want to call. If the handset is out of range or not set to DirectLink communication, the display shows UNAVAILABLE.
3. To answer a DirectLink call, press **[ / flash]**. (If Any Key Answer is on you can also press any key on the twelve-key number pad.) To end the call, press **[ ]**.

```
To DirectLink
a handset
press [1-4]
```

## Exiting DirectLink Communication

While the handset is using DirectLink communication, the display shows DIRECTLINK MODE; this means the handset cannot make or receive normal phone calls. To exit DirectLink communication and return to normal standby, simply return the handset to the cradle, or press **[menu/clear]** followed by **[select/ ]**. DIRECTLINK MODE CANCEL appears in the display.

```
SUN 12:00A
Handset #1
DirectLink Mode
```

## Using the Intercom

You can use the intercom to talk to another station without using the phone line.

### Making an Intercom Page

From the base	From the handset
<ol style="list-style-type: none"><li>1. With the phone in standby, press <b>[int'com]</b> (<b>[hold/int'com/xfer]</b> on the dual-keypad base). All other stations will be paged. (On the dual-keypad base, press <b>[1]</b> through <b>[4]</b> to select the handset you want to talk with or press <b>[*/tone]</b> to page all stations.)</li><li>2. To cancel the intercom page, press <b>[int'com]</b> (<b>[hold/int'com/xfer]</b> on the dual-keypad base).</li></ol>	<ol style="list-style-type: none"><li>1. With the phone in standby, press <b>[xfer/intercom]</b>.</li><li>2. Use <b>[▲]</b> or <b>[▼]</b> to select the station you want to talk with, then press <b>[select/☐]</b>. Select ALL to page all other stations paged.</li><li>3. To cancel the intercom page, press <b>[⏏]</b>.</li></ol>

**Note: Intercom paging will be canceled if any of the following things occur:**

- You receive an outside call or an intercom page while selecting the other handset.
- You do not select a handset within 30 seconds.
- The party does not answer the page within one minute.
- The party is busy.
- The party is out of range (UNAVAILABLE appears in the display).

### Answering an Intercom Page

When the intercom page tone sounds, the display will show the ID of the station that is paging.

1. From the handset, press **[ / flash]** or **[xfer/intercom]**. If AutoTalk is on, the handset will automatically answer the page when you remove the handset from the cradle.
2. From the base, press **[int'com]** (**[hold/int'com/xfer]** on the dual-keypad base) or **[speaker]**.
3. To hang up an intercom page from the handset, press **[⏏]**. To hang up an intercom page from the base, press **[int'com]** (**[hold/int'com/xfer]** on the dual-keypad base).

## Room/Baby Monitor

This feature allows you to monitor sounds in another room. Place a station in the room you wish to monitor; it will function as a microphone. Any handset can be set to function as a remote speaker, allowing you to monitor sounds in the room.

1. Press **[menu/clear]** and enter the ROOM MONITOR menu. TO ROOM MONITOR appears in the display.
2. Use **[▲]** or **[▼]** to select the station you want to monitor.
3. Press **[select/ ]**. ROOM MONITOR appears, and you hear sounds in the room where the station is installed.
4. To turn off the room monitor, press **[ ]** or return the handset to the cradle.

### Note:

**This feature only works when handsets are within the range of the base.**

**If the party is out of range, UNAVAILABLE appears in the display, and the operation will be canceled.**

**While a pair of handsets is in Room/Baby Monitoring, they cannot be used to make or receive calls. Other handsets can still make and receive calls.**

**You cannot listen from the base; the base can only function as a microphone.**

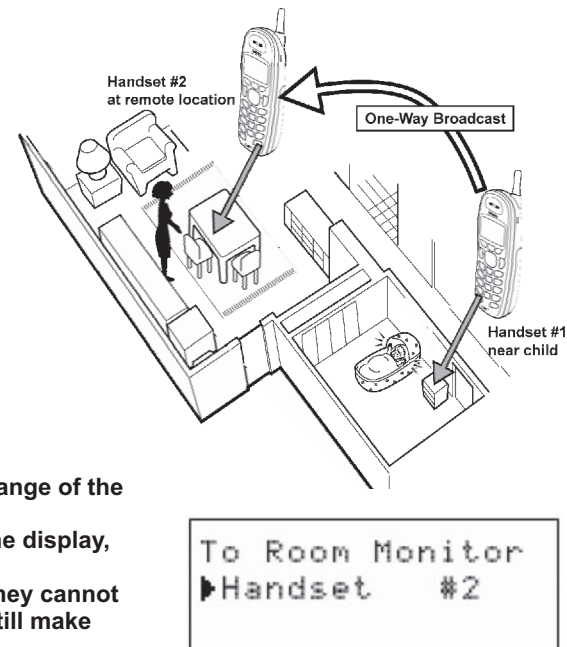

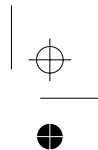
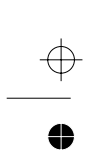

### **Tone Dialing Switch Over (Australian Model Only)**

If your phone is set to pulse dialing, you can switch to tone dialing after the call connects. This feature is useful when you need tone dialing to use automated menu systems, such as telephone bank tellers, telephone prescription refills, customer support menus, etc. Make your call normally. Once your call connects, press **[\*/tone/<]** on the handset or **[\*/tone]** on the dual-keypad base. Any digits you enter from then on will be sent with tone dialing. When this particular call ends, the phone automatically returns to pulse dialing.

See *Changing the Dial Mode (Australian Model Only)* on page 16 for instructions on setting your phone for pulse or tone dialing.

### **Installing the Optional Headset**

Your phone may be used with an optional headset. To use this feature, insert the headset plug into the headset jack. Your phone is ready for hands-free conversations. (Headsets may be purchased by visiting [www.uniden.com.au](http://www.uniden.com.au) (Australian Model) or [www.uniden.co.nz](http://www.uniden.co.nz) (New Zealand Model).

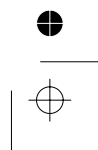
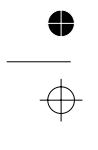
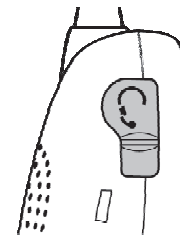

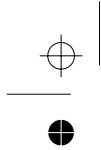

## Setting Up the Answering System

Your phone has a built-in answering system that answers and records incoming calls. You can also use your answering system to record a conversation or leave a voice memo.

### Features

- Digital Tapeless Recording
- Call Screening
- Voice Prompts for Menu Setup
- Records Up to 59 messages
- Remote Message Retrieval
- Voice Memo
- Hands Free Speakerphone at Base
- Up to 12 Minutes of Recording Time
- Personal or Pre-recorded Outgoing Messages
- Day and Time Announcement
- Conversation Recording
- Toll Saver
- Message Alert

Digital Tapeless Recording allows you to quickly review, save, or delete the messages you choose. You will never have to worry about a tape wearing out, jamming, or resetting improperly.

### Voice Prompts

You can set up your answering system's primary features from the base with voice prompt instructions. The following seven items may be set up using the voice prompts: Time, Security Code, Ring Time, Record Time, Message Alert and Call Screening.

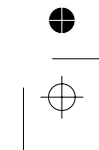
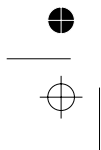

## Using the Answering System Interface

### Base operation

When the phone is in standby, press **[menu/clock]** to scroll through the answering system setup menu options. Each menu option has voice prompt instructions; you can press the next key at any time during the instructions. After the last option, call screening, the system returns to standby if you press **[menu/clock]**. You can exit the system at any time by pressing **[P/□]**. If you receive a call or a handset makes a call while you are in the setup menus, the operation is cancelled.



### Handset operation

You can use your handset to operate your answering system from anywhere in your home. When the phone is in standby, press **[select/☑]** on the handset to access the answering system. REMOTE ANSWERING MACHINE OPERATION appears on the handset display, and the system announces the number of new and old messages. Keep the following things in mind when you use your handset to access your answering system:

- You can enter a command at any time during announcements.
- After the first announcement, you have 30 seconds to enter your first command before the system returns to standby.
- If you receive a call, the remote operation is cancelled.
- If another station makes a call, the remote operation is cancelled.
- During the remote operation “ - - ” appears on the base.

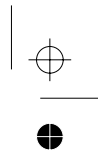
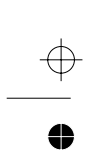

## Setting the Number of Rings

The ring time setting allows you to set the number of rings the caller hears before your answering system plays the outgoing message. You can set the ring time to answer after six, nine or twelve rings. If you enable the Toll Saver (TS) setting, the answering system picks up after two rings if you have new messages, and after four rings if there are none. This way, if you make a long distance call to check your messages, you can hang up after the second ring to avoid long distance billing charges.

From the base	From the handset
<ol style="list-style-type: none"><li>1. Press <b>[menu/clock]</b> three times. The base displays the current number of rings (6, 9, 12, or TS for toll saver) and announces the setting.</li><li>2. Press <b>[&gt;&gt; /select]</b> or <b>[&lt;&lt; /select]</b> until the desired ring time appears.</li><li>3. Press <b>[set]</b>. A confirmation tone sounds, and the system announces the new ring time.</li></ol>	<ol style="list-style-type: none"><li>1. Press <b>[menu/clear]</b>. Select the ANSW. SETUP menu, and then the RING TIME submenu.</li><li>2. Move the cursor to select a ring time (TOLL SAVER, 6 TIMES, 9 TIMES, or 12 TIMES).</li><li>3. Press <b>[select/ ]</b>. You will hear a confirmation tone.</li></ol>

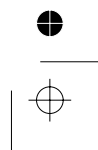
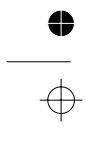

## Setting the Day & Time

If you do not set the clock on your answering system, your messages may not have the correct time and day stamp.

You can set the day and time from the handset or the base.

From the base	From the handset
<ol style="list-style-type: none"><li>1. Press <b>[menu/clock]</b>.</li><li>2. Press <b>[&gt;&gt;] /select</b> or <b>[&lt;&lt;] /select</b> until the correct day is announced and the message counter shows the corresponding number (1 for Sunday, 2 for Monday, etc.).</li><li>3. Press <b>[set]</b> to select the day.</li><li>4. Press <b>[&gt;&gt;] /select</b> or <b>[&lt;&lt;] /select</b> until you hear the correct hour setting. The numbers 1 through 12 appear on the base as each hour is announced.</li><li>5. Press <b>[set]</b> to select the hour.</li><li>6. Press <b>[&gt;&gt;] /select</b> or <b>[&lt;&lt;] /select</b> until you hear the correct minute setting. The numbers 00 through 59 appears on the base as each minute is announced.</li><li>7. Press <b>[set]</b> to select the minute.</li><li>8. Press <b>[&gt;&gt;] /select</b> or <b>[&lt;&lt;] /select</b> until you hear the correct AM or PM setting. The message counter displays A or P.</li><li>9. Press <b>[set]</b> to select the AM/PM setting. A confirmation tone sounds, and the day and time are announced for your review.</li></ol>	<ol style="list-style-type: none"><li>1. Press <b>[menu/clear]</b>.</li><li>2. Move the cursor to GLOBAL SETUP and press <b>[select/☑]</b>.</li><li>3. Move the cursor to DAY &amp; TIME and press <b>[select/☑]</b>.</li><li>4. Use <b>[▲]</b> and <b>[▼]</b> to select the correct day, and press <b>[select/☑]</b>.</li><li>5. Use <b>[▲]</b> and <b>[▼]</b> to select the correct hour, and press <b>[select/☑]</b>.</li><li>6. Use <b>[▲]</b> and <b>[▼]</b> to select the correct number of minutes, and press <b>[select/☑]</b>.</li><li>7. Use <b>[▲]</b> and <b>[▼]</b> to select AM or PM, and press <b>[select/☑]</b>. You hear a confirmation tone.</li></ol>



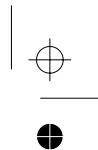
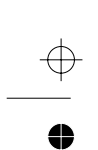

## Recording a Personal Greeting

Your answering system comes with a pre-recorded outgoing message or greeting that plays when you receive a call:

"Hello, no one is available to take your call. Please leave a message after the tone." You can record your own personal outgoing greeting. Your recorded greeting must be between two seconds and thirty seconds long.

From the base	From the handset
<ol style="list-style-type: none"><li>1. Press and hold <b>[greet]</b>.</li><li>2. The system announces, "Record greeting." Begin recording after the announcement.</li><li>3. The message counter displays "- -", then begins to count down.</li><li>4. When you finish recording, press <b>[greet]</b>, <b>[set]</b>, or <b>[▷/□]</b>. You will hear a confirmation tone, and your recorded greeting plays back for you.</li></ol>	<ol style="list-style-type: none"><li>1. Press <b>[select/ ☐]</b>. The system announces the number of new and old messages (or "Answering system is off.").</li><li>2. Press <b>[8]</b> at any time during the announcement.</li><li>3. The system announces, "Record greeting." Begin recording after the announcement.</li><li>4. The message counter on the base displays "- -".</li><li>5. When you finish recording, press <b>[□/5]</b> or <b>[8]</b>. You will hear a confirmation tone, and your recorded greeting plays back for you.</li></ol>

## Selecting a Greeting

Once you have recorded a personal greeting, the phone automatically switches to your personal greeting. You can also switch back and forth between the pre-recorded greeting and your own greeting at any time from the base:

1. With the phone in standby, press **[greet]**. The system plays the current greeting.
2. To keep this greeting, do nothing.
3. To switch to the other greeting, press **[greet]** while the system is playing the current greeting.
4. Each time you press **[greet]**, the system switches between the pre-recorded and the personal greeting. The last greeting you hear is used as the current greeting.

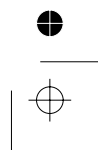
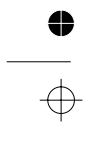

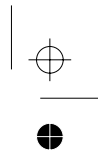
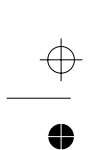

### Deleting Your Personal Greeting

You can delete your personal greeting from the base. You cannot delete the pre-recorded greeting.

1. With the phone in standby, press **[greet]**.
2. While the personal greeting is playing, press **[∅]**.
3. The system announces "Greeting has been deleted," and switches back to the pre-recorded greeting.

### Setting the Record Time (or Announce Only)

You can choose how long callers have to record a message. Set the record time to "1 minute" or "4 minutes" to limit the time for incoming messages. If you set the record time to "Announce only," the answering system answers the call but prevents callers from leaving a message.

From the base	From the handset
<ol style="list-style-type: none"><li>1. Press <b>[menu/clock]</b> four times. The base displays the current number of rings recording time (1 minute, 4 minutes, or A for announce only) and announces the setting.</li><li>2. Press <b>[&gt;&gt; /select]</b> or <b>[&lt;&lt; /select]</b> until the desired message record time appears.</li><li>3. Press <b>[set]</b> to select the new recording time. A confirmation tone sounds, and the system announces the new record time.</li></ol>	<ol style="list-style-type: none"><li>1. Press <b>[menu/clear]</b>. Select the ANSW. SETUP menu, and then the RECORD TIME submenu.</li><li>2. Move the cursor to select RECORD TIME (1 MINUTE, 4 MINUTES, or ANNOUNCE ONLY).</li><li>3. Press <b>[select/☑]</b>. You will hear a confirmation tone.</li></ol>

While your answering system is set to Announce Only, the message counter LED on the base displays "A." If you are using the prerecorded greeting, the system automatically switches to the following message: "Hello, no one is available to take your call. Please call again." If you are using a personal greeting, the system continues to use that greeting.

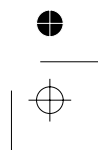
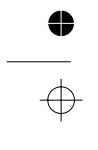

## Activating the Message Alert

The message alert feature sounds a short alert tone every 15 seconds whenever you have a new message. To turn on the message alert:

From the base	From the handset
<ol style="list-style-type: none"><li>1. Press [<b>menu/clock</b>] five times. The current setting (ON or OFF) appears on the base and it is announced.</li><li>2. Press [<b>&gt;&gt; /select</b>] or [<b>&lt;&lt; /select</b>] to choose ON or OFF.</li><li>3. Press [<b>set</b>]. A confirmation tone sounds, and the system announces the new setting. When the first new message is received, the alert tone will begin to sound.</li></ol>	<ol style="list-style-type: none"><li>1. Press [<b>menu/clear</b>]. Select the ANSW. SETUP menu, and then the MESSAGE ALERT submenu.</li><li>2. Move the cursor to select ON or OFF.</li><li>3. Press [<b>select/☑</b>]. You will hear a confirmation tone.</li></ol>

## Activating Call Screening

Your phone allows you to listen to callers leaving you a message. This call screen feature can be turned on or off.

From the base	From the handset
<ol style="list-style-type: none"><li>1. Press [<b>menu/clock</b>] six times. The current call screen setting (ON or OFF) appears on the base.</li><li>2. Press [<b>&gt;&gt; /select</b>] or [<b>&lt;&lt; /select</b>] to choose ON or OFF.</li><li>3. Press [<b>set</b>]. A confirmation tone sounds, and the system announces the new setting.</li></ol>	<ol style="list-style-type: none"><li>1. Press [<b>menu/clear</b>]. Select the ANSW. SETUP menu and then the CALL SCREEN submenu.</li><li>2. Move the cursor to select ON or OFF.</li><li>3. Press [<b>select/☑</b>]. You will hear a confirmation tone.</li></ol>

### Setting a Security Code or Personal Identification Number (PIN)

To play your messages from a remote location, you will need to enter a two-digit security code or Personal Identification Number (PIN). The default security code is 80.

From the base	From the handset
<ol style="list-style-type: none"><li>1. Press <b>[menu/clock]</b> twice. The current security code appears on the base and it is announced.</li><li>2. Press <b>[&gt;&gt; /select]</b> or <b>[&lt;&lt; /select]</b> until the desired number appears. Press and hold <b>[&gt;&gt; /select]</b> or <b>[&lt;&lt; /select]</b> to quickly scroll through the numbers on the display.</li><li>3. Press <b>[set]</b> to select the security code. A confirmation tone sounds; the system announces the new security code.</li></ol>	<ol style="list-style-type: none"><li>1. Press <b>[menu/clear]</b>. Select the ANSW. SETUP menu, and then the SECURITY CODE submenu.</li><li>2. Use the number keypad (<b>[0]</b> through <b>[9]</b>) to enter a two-digit security code (00-99) .</li><li>3. Press <b>[select/☐]</b> . You will hear a confirmation tone.</li></ol>

## Using the Answering System

### Turning Your Answering System On and Off

	From the base	From the handset
<b>Turning On</b>	<ol style="list-style-type: none"> <li>1. With the phone in standby, press <b>[on/off]</b>.</li> <li>2. The system announces "Answering System is on" and plays the current greeting.</li> <li>3. The message counter displays the number of messages stored in memory. If the counter flashes, then you have new messages waiting.</li> </ol>	<ol style="list-style-type: none"> <li>1. With the phone in standby, press <b>[select/ ☐ ]</b> . REMOTE ANSWERING MACHINE OPERATION appears on the display, and the answering system announces the number of new and old messages.</li> <li>2. Press <b>[6]</b> at any time during the announcement.</li> <li>3. The system announces "Answering System is on" and plays the current greeting message.</li> </ol>
<b>Turning Off</b>	<ol style="list-style-type: none"> <li>1. With the phone in standby, press <b>[on/off]</b>.</li> <li>2. The phone announces "Answering System is off."</li> <li>3. The message counter LED is no longer illuminated.</li> </ol>	<ol style="list-style-type: none"> <li>1. With the phone in standby, press <b>[select/ ☐ ]</b> . REMOTE ANSWERING MACHINE OPERATION appears on the display, and the answering system announces the number of new and old messages.</li> <li>2. Press <b>[9]</b> at any time during the announcement. The system announces "Answering System is off."</li> </ol>

### Reviewing Messages

The base message counter displays the number of messages stored in memory. When you have new messages, the message counter and the new message LED on the handset flash. The answering system plays your new messages first. After you listen to all of your new messages, you can then play your old messages. You can review your messages from the base or from the handset:

	<b>From the base</b>	<b>From the handset</b>
<b>Playing messages</b>	Press [ <b>▷/□</b> ]. The system announces the number of new and old messages. It announces the message number, plays the message, then announces the time and day it was received.	Press [ <b>select/ ☑</b> ]. The system announces the number of new and old messages. Press [ <b>▷/2</b> ] to play your messages. After playing the message, the system announces the time and day that message was received.
<b>Repeating a message</b>	Press [ <b>◀ /select</b> ] once to go to the beginning of the current message. Press [ <b>◀ /select</b> ] repeatedly to go back to a previous message. Press and hold [ <b>◀ /select</b> ] to rewind through the current message.	Press [ <b>◀ /1</b> ] once to go to the beginning of the current message. Press [ <b>◀◀ /1</b> ] repeatedly to go back to a previous message.
<b>Skipping a message</b>	Press [ <b>▶ /select</b> ] to go to the beginning of the next message. Press and hold [ <b>◀ /select</b> ] to fast forward through the current message.	Press [ <b>▶ /3</b> ] to go to the beginning of the next message.
<b>Deleting a message</b>	While a message is playing, press [ <b>∅</b> ]. The message is permanently deleted.	While a message is playing, press [ <b>∅ /4</b> ]. The message is permanently deleted.
<b>Deleting all messages</b>	While the phone is in standby, press [ <b>∅</b> ]. When the system asks you to confirm, press [ <b>∅</b> ] again. All messages are permanently deleted.	Not available
<b>Ending the message review</b>	Press [ <b>▷/□</b> ] to stop the message playback and return to standby.	Press [ <b>□ /5</b> ] to stop the message playback. Press [ <b>⏏</b> ] to exit the system and return to standby.

## Screening Calls

If you activate the call screening feature, you can listen to callers leaving a message without answering the phone (see *Activating Call Screening* on page 50). You can always hear callers from the base speaker. To screen an incoming call from the handset:

- Press [**select/**☒] when the system is answering. If another handset is screening a call, you will hear a beep and you will not be able to screen the call.
- To answer the call, press [ **/ flash**].
- To stop screening the call, press [ **]**.

## Recording a Conversation

You can record a conversation between two seconds and ten minutes long from the handset or the base. These recorded conversations are treated just like regular messages. When the answering system is full, FL will appear on the base LCD and recording will be terminated. You can not record three-way calls or intercom conversations.

	From the base	From the handset
<b>Starting a recording</b>	<ol style="list-style-type: none"><li>1. During a conversation, press and hold [<b>memo/call rec</b>].</li><li>2. The message counter LED flashes "- -". A confirmation tone that can be heard by both parties sounds during recording.</li></ol>	<ol style="list-style-type: none"><li>1. During a conversation, press [<b>menu/clear</b>].</li><li>2. Move the cursor to select CALL RECORD, and then press [<b>select/</b>☒].</li><li>3. RECORDING A CALL and R appear on the display. A confirmation tone that can be heard by both parties sounds during recording.</li></ol>
<b>Stopping a recording</b>	<ol style="list-style-type: none"><li>1. Press [<b>memo/call rec</b>], or [<b>▷/□</b>].</li><li>2. You will hear a confirmation tone, and the message counter LED stops flashing.</li></ol>	<ol style="list-style-type: none"><li>1. Press [<b>menu/clear</b>].</li><li>2. Move the cursor to select CALL RECORD, and then press [<b>select/</b>☒].</li><li>3. STOP RECORDING appears on the display, and you hear a confirmation tone.</li></ol>

**Note:** Every state has different regulations governing the recording of conversations over the telephone. Make sure to check your local, state and federal laws before using this product to record any telephone conversation in order to determine that your use is in compliance with such laws or guidelines.

## Recording a Voice Memo

The voice memo feature allows you to record messages that are between two seconds and four minutes long. You might want to use this feature to leave messages for other members of your household instead of written notes.

	From the base	From the handset
<b>Starting a memo</b>	<ol style="list-style-type: none"><li>1. With the phone in standby, press and hold <b>[memo/call rec]</b> until you hear a beep.</li><li>2. The system announces "Record memo message." Begin your message after this announcement.</li><li>3. While you are recording, the message counter LED flashes "- -".</li></ol>	<ol style="list-style-type: none"><li>1. With the phone in standby, press <b>[select/ ✉ ]</b>.</li><li>2. REMOTE ANSWERING MACHINE OPERATION appears on the display, and the answering system announces the number of new and old messages.</li><li>3. Press <b>[7]</b>. The system announces "Record memo message." Begin your message after this announcement.</li></ol>
<b>Stopping a memo</b>	<ol style="list-style-type: none"><li>1. Press <b>[memo/call rec]</b>, <b>[▶/□]</b>, or <b>[set]</b>.</li><li>2. You hear a confirmation tone, and the system returns to standby.</li></ol>	<ol style="list-style-type: none"><li>1. Press <b>[□/5]</b> or <b>[7]</b>. You hear a confirmation tone, and the system waits for your next command.</li><li>2. Press <b>[▶/2]</b> to hear the message you just recorded or <b>[ ]</b> to exit the system and return to standby.</li></ol>

## Turning Off the Message Alert Tone

The tone will not deactivate until all new messages are played back. To quickly turn off the tone, press any key on the base.



## Operating the Answering System While You Are Away from Home

You can access your answering system while you are away from home to check, play, and delete messages, or even record a new greeting message or turn your answering system on and off.

To operate from a remote location, use any touch-tone telephone, and follow these steps:

1. Call your telephone number and wait for the system to answer. If the answering system is off, it will answer after about 15 rings and sounds a series of beeps.
2. During the greeting or the beeps (if answering system is off), press [#] and enter your security code/PIN within two seconds (see *Setting a Security Code or Personal Identification Number (PIN)* on page 51).
3. The answering system announces the current time and the number of messages stored in memory. You hear "To play incoming messages, press pound-two. For help, press pound-zero" followed by a beep. Pressing pound is the same as pressing [#].
4. Enter a remote command from the chart below. You have 15 seconds to enter the first command; after the first command, you have two seconds to enter each command.

Command	Function	Command	Function
[#] then [1]	Repeat a message*	[#] then [6]	Answering system on
[#] then [2]	Play incoming messages	[#] then [7]	Memo record start/stop
[#] then [3]	Skip a message	[#] then [8]	Greeting message record start/stop
[#] then [4]	Delete a message	[#] then [9]	Answering system off
[#] then [5]	Stop operation	[#] then [0]	Help

\* If you press [#] then [1] in the first four seconds of a message, the system skips to the previous message. If you press [#] then [1] after the first four seconds of a message, the system repeats the current message.

5. When you finish, you will hear intermittent beeps indicating that the system is in the command waiting mode. Enter another command from the chart within two seconds.
6. Hang up to exit the system. The answering system automatically returns to its normal standby setting.



## Maintenance Specifications

Operating Temperature	0° C to +50° C (+32° F to +122° F)	
<b>AC Adapter</b>	Part Number	Base: AAD-041S Charging cradle: AAD-600S
	Input Voltage	Base: 240V AC, 50 Hz Charging cradle: 240V AC, 50 Hz
	Output Voltage	Base: 9V DC @ 350 mA Charging cradle: 9V DC @ 210 mA
<b>Battery</b>	Part Number Capacity	BT-909 3.6V DC @ 600 mAh

### Power Failures

During a power failure, you will not be able to make or receive calls with the phone. To avoid damage from an electrical spike when the power comes back on, we recommend you unplug your phone during power outages.

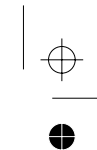
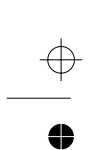

## Battery Life

With average use, your battery talk time will be approximately 8 hours and standby time will be approximately 7 days. For optimum performance, be sure to return the handset to the cradle after each call. If the handset is left off of the base, the actual talk time duration will be reduced respective to the amount of time the handset is off the cradle.

**Note: Do not place the power cord where it creates a trip hazard or where it could become chafed and create a fire or electrical hazard.**

## Low Battery Alert

When the battery pack is very low, the phone is programmed to eliminate functions in order to save power. The battery pack needs to be charged when the display shows LOW BATTERY and the empty battery icon. If the phone is in standby, none of the keys will operate. If you are on a call, complete your conversation as quickly as possible, and return the handset to the charging cradle.



## Battery Replacement and Handling

When the talk time becomes short, even after the battery is recharged, please replace the battery. With normal usage, your battery should last about one year. A replacement Uniden adapter or battery may be purchased by visiting [www.uniden.com.au](http://www.uniden.com.au) (Australian Model) or [www.uniden.co.nz](http://www.uniden.co.nz) (New Zealand Model).

### Warning

**To avoid the risk of personal injury or property damage from fire or electrical shock, use only BT-909 battery pack with your phone.**

### Caution:

**Do not remove the batteries from the handset to charge them. Never throw the battery into a fire, disassemble them, or heat them. Do not remove or damage the battery casing.**

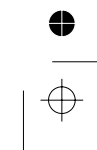
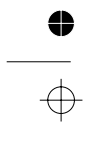

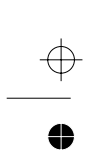

## Change the Batteries Annually

Even when the battery pack is not being used, it will gradually discharge over a long period of time. With average use, your phone's battery should last approximately one year. To order replacement batteries, visit [www.uniden.com.au](http://www.uniden.com.au) (Australian Model) or [www.uniden.co.nz](http://www.uniden.co.nz) (New Zealand model).

## Clean the Battery Contacts

To maintain a good charge, clean the charging contacts on the handset once a month. Dampen a cloth with plain water. Gently rub the damp cloth over the charging contacts until all visible dirt is removed. Dry the contacts thoroughly before returning the handset to the charging cradle.

**Caution: Do not use paint thinner, benzene, alcohol, or other chemical products. Doing so may discolor the surface of the telephone and damage the finish.**

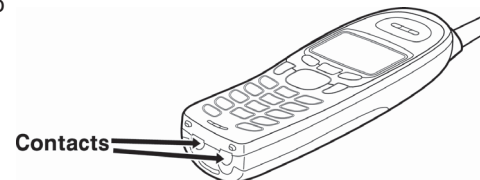

## Troubleshooting

### Resetting the Handset

You may need to reset your handset in the following instances:

- When you want to change the digital security code.
- When you lose a handset and purchase a new one.
- When you get the message Registration Failed when you try to register the handset.
- When you are unable to register any handsets to the base.
- When you register new handsets to the base, the handset IDs do not match. (For example, the handset registers as "Handset #4" but you only have two handsets.)

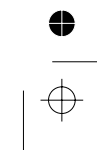
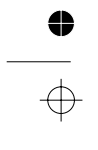

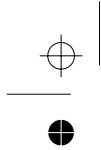

1. Press and hold [ **.** ] and [ **#>** ] for more than 5 seconds. Select DEREGISTER HS.
2. Select the handset you want to reset, then press [ **select/☑** ] .
3. The phone will ask you to confirm the deregistration. Select YES. The selected handset will clear its registration information from the base, and then delete the link to the base from its own memory.
4. When the base information is deleted, the handset displays MODELS VARY! CHARGE HANDSET ON THE BASE FOR REGISTRATION OR REFER TO OWNER'S MANUAL.
5. Re-register the handset to the base (see *Registering Accessory Handsets* on page 20).

If the handset cannot contact the base, it will display UNAVAILABLE. Make sure the handset is in range of the base and the base is connected to power.

### **Resetting the Handset Without the Base**

If your original base is not available for some reason (for example, it is lost or somehow incapacitated), you can still reset the handset and use it with another base.

1. Press and hold [ **.** ] and [ **#>** ] for at least 5 seconds.
2. Move the cursor to select REPLACING BASE and then press [ **select/☑** ] . REPLACE BASE appears.
3. Move the cursor to select YES, and then press [ **select/☑** ] . You hear a confirmation tone, and the handset deletes its own base information without contacting the base. The handset displays MODELS VARY! CHARGE HANDSET ON THE BASE FOR REGISTRATION OR REFER TO OWNER'S MANUAL.
4. Register the handset to the new base (see *Registering Accessory Handsets* on page 20).

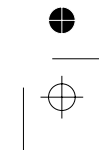
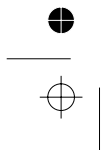

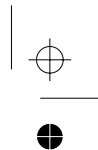
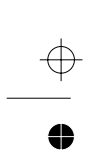

## Changing the Digital Security Code

The digital security code is an identification code used to connect the handset and the base. Your unit ships from the manufacturer with a preset security code. Resetting this code is not normally necessary. In the rare situation that you suspect another cordless telephone is using the same security code or if you are instructed to change this code by a manufacturer's Call Center Representative, you can change the code. To change the digital security code:

1. Reset the handset (see *Resetting the Handset* on page 59).
2. Re-register each handset (see *Registering Accessory Handsets* on page 20).

## Traveling Out of Range

During a call, if you move your handset too far from your base, noise may increase. If you pass the range limit of the base, the handset will beep, display OUT OF RANGE, and then go to standby. The base will maintain the connection for 30 seconds after the handset goes out of range. If you move the handset back within range of the base within 30 seconds, press [ **FLASH** ] or [ **END CALL** ] to pick up the call again.

## Common Issues

If your phone is not performing to your expectations, please try these simple steps first. If these steps do not solve your problem, visit the customer support page at [www.uniden.com.au](http://www.uniden.com.au) (Australian Model) or [www.uniden.co.nz](http://www.uniden.co.nz) (New Zealand model).

Symptom	Suggestion
The charge LED won't illuminate when the handset is placed in the cradle.	<ul style="list-style-type: none"><li>• Make sure the AC adapter is plugged into the base or the charger (if you have more than one handset) and wall outlet.</li><li>• Make sure the handset is properly seated in the cradle.</li><li>• Make sure the charging contacts on the handset are clean.</li></ul>
The audio sounds weak.	<ul style="list-style-type: none"><li>• Move the handset and/or base away from metal objects or appliances and try again.</li><li>• Make sure that you are not too far from the base.</li></ul>

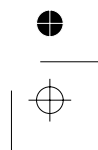
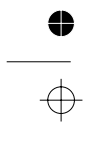

Symptom	Suggestion
Can't make or receive calls.	<ul style="list-style-type: none"> <li>• Make sure that you are not too far from the base.</li> <li>• Make sure the line is not in use. If an outside call is already using a line, you cannot use that line to make another outside call.</li> <li>• Check both ends of the base telephone line cord.</li> <li>• Make sure the AC adapter is plugged into the base and wall outlet.</li> <li>• Disconnect the AC adapter and reconnect.</li> <li>• Change the Digital Security Code (see <i>Changing the Digital Security Code</i> on page 61).</li> </ul>
Severe noise interference.	<ul style="list-style-type: none"> <li>• Keep the handset away from microwave ovens, computers, remote control toys, wireless microphones, alarm systems, intercoms, room monitors, fluorescent lights, and electrical appliances.</li> <li>• Move to another location or turn off the source of interference.</li> </ul>
The Caller ID does not display.	<ul style="list-style-type: none"> <li>• The call was placed through a switchboard.</li> <li>• Call your telephone provider to verify your Caller ID service is current. There may be a problem with your Caller ID service.</li> </ul>
The handset doesn't ring or receive a page.	<ul style="list-style-type: none"> <li>• Make sure that you are not too far from the base.</li> <li>• Charge the battery in the handset for 15 to 20 hours by placing the handset on the base or charging cradle.</li> <li>• Change the Digital Security Code (see <i>Changing the Digital Security Code</i> on page 61).</li> </ul>
You cannot register the handset at the base.	<ul style="list-style-type: none"> <li>• Charge the battery pack in the handset for 15 to 20 hours.</li> <li>• Change the Digital Security Code (see <i>Changing the Digital Security Code</i> on page 61).</li> </ul>

Symptom	Suggestion
The handset doesn't communicate with other handsets.	<ul style="list-style-type: none"> <li>• Change the Digital Security Code (see <i>Changing the Digital Security Code</i> on page 61).</li> <li>• Make sure that you have registered all handsets (see <i>Registering Accessory Handsets</i> on page 20).</li> </ul>
An extra handset can't join the conversation.	<ul style="list-style-type: none"> <li>• Make sure there are not two handsets already using the conference feature.</li> <li>• Make sure that another handset is not in privacy mode.</li> </ul>
Room Monitor does not work.	<ul style="list-style-type: none"> <li>• Make sure to place the handset(s) within the range of the base.</li> </ul>
The answering system does not work.	<ul style="list-style-type: none"> <li>• Make sure the base is plugged in.</li> <li>• Make sure that the answering system is turned on.</li> </ul>
Time stamp cannot be heard.	<ul style="list-style-type: none"> <li>• Make sure you have set the time (see <i>Setting the Day and Time</i> on page 17).</li> <li>• Make sure that the message record time is not set to announce only.</li> </ul>
Messages are incomplete.	<ul style="list-style-type: none"> <li>• Incoming messages may be too long. Ask callers to leave a brief message.</li> <li>• The memory may be full. Delete some or all of the saved messages.</li> </ul>
There is no sound on the base or handset speaker during call monitoring or message review.	<ul style="list-style-type: none"> <li>• Adjust the speaker volume on the base or handset.</li> <li>• Make sure the call screen feature is set to on.</li> </ul>
Cannot access answering system from a remote phone.	<ul style="list-style-type: none"> <li>• Make sure you are using the correct PIN number.</li> <li>• Make sure that the touch-tone phone you're using can transmit the tone for at least two seconds. If it cannot, try using a different touchtone phone.</li> </ul>



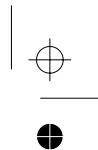
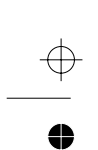

## Liquid Damage

Moisture and liquid can damage your cordless phone.

- If the handset or base is exposed to moisture or liquid, but only the exterior plastic housing is affected, wipe off the liquid, and use as normal.
- If moisture or liquid has entered the plastic housing (i.e. liquid can be heard in the phone or liquid has entered the handset battery compartment or vent openings on the base), follow the steps below:

Handset	Base
<ol style="list-style-type: none"><li>1. Remove the battery cover and leave it off for ventilation.</li><li>2. Disconnect the battery pack. Leave the battery cover off and the battery pack disconnected for at least 3 days.</li><li>3. Once the handset is completely dry, reconnect the battery pack and the battery cover.</li><li>4. Recharge the handset's battery pack for 15 to 20 hours before using.</li></ol>	<ol style="list-style-type: none"><li>1. Disconnect the AC adapter from the base, cutting off electrical power.</li><li>2. Disconnect the telephone cord from the base.</li><li>3. Let dry for at least 3 days.</li></ol>

**IMPORTANT:** You must unplug the telephone line while recharging the battery packs to avoid charge interruption.  
**CAUTION:** DO NOT use a microwave oven to speed up the drying process. This will cause permanent damage to the handset, base and the microwave oven. After following these steps, if your cordless telephone does not work, please, visit the customer support page at [www.uniden.com.au](http://www.uniden.com.au) (Australian Model) or [www.uniden.co.nz](http://www.uniden.co.nz) (New Zealand model).

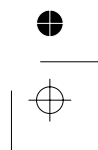
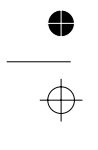

## Index

- Answering calls..... 30
- Answering system..... 44
  - Using the handset..... 45
  - When away from home ..... 56
- Any key answer ..... 29
- AutoTalk ..... 29
- Baby monitor ..... 42
- Banner..... 27
- Base
  - Installing ..... 13
  - Parts of the base..... 8
  - Parts of the dual keypad
    - base ..... 9
    - Wall mounting..... 13
- Battery
  - Installing ..... 14
  - Low battery alert ..... 58
  - Replacement and handling..... 58
  - Talk and standby time..... 58
- Belt clip..... 16
- Call recording ..... 54
- Call screening..... 50, 54
- Call waiting ..... 33
- Caller ID ..... 32
  - Caller ID on call waiting..... 17
  - Deleting Caller ID numbers..... 33
  - Making calls from..... 32
- Clarity booster ..... 10, 36
- Conferencing..... 37
- Day and time..... 17, 47
- Dial mode..... 16, 43
- DirectLink..... 40
  - Making a call ..... 40
- Distinctive Ring ..... 17
- Do not disturb..... 38
- Finding a handset..... 36
- Greetings
  - Deleting ..... 49
  - Recording ..... 48
  - Selecting..... 48
- Handset
  - Accessing the answering system..... 45
  - Accessory handsets ..... 19
  - Banner ..... 27
  - Choosing a ringer..... 28
  - Copying phonebook entries..... 25
  - Displays and icons ..... 10
  - Entering text..... 12
  - Finding ..... 36
  - Parts of the handset..... 7
  - Registering..... 20
  - Resetting..... 21, 59
  - Standby screen ..... 11
- Hanging up..... 30
- Headset..... 43
- Hold..... 36
- Insert 0 ..... 18
- Installation ..... 13
- Intercom..... 41
- Key touch tone..... 18
- Keypad Lock ..... 31
- Maintenance..... 57
- Making calls..... 30
  - Using Caller ID ..... 32
  - Using redial ..... 34
  - Using speed dial ..... 31
  - Using the phonebook..... 31
- Message alert ..... 50, 55
- Mute
  - Microphone ..... 39
  - Ringer ..... 38
- Name Tag ..... 18
- Out of range ..... 61
- Personal identification
  - number (PIN)..... 51
- Phonebook ..... 22
  - Copying entries ..... 25
  - Creating new entries..... 22
  - Deleting entries..... 25
  - Editing entries..... 24
  - Finding entries..... 24
  - Making calls from..... 31
  - Storing Caller ID or redial numbers... 24
- Power failure operation ..... 57
- Privacy mode..... 10, 39
- Pulse dialing ..... 16, 43
- Recording a call ..... 54
- Recording a voice memo..... 55
- Redial
  - Deleting a record..... 34
  - Making calls with ..... 34
- Ringer
  - Choosing a handset ringer..... 28
  - Muting..... 38
  - Distinctive ring..... 17
- Room monitor..... 42
- Screening calls..... 50, 54
- Security code ..... 61
  - answering system ..... 51
- Speed dial
  - Making calls from..... 31
  - Programming..... 23
  - Programming on the dual-keypad base..... 26
- Text, entering ..... 12
- Tone dialing..... 16, 43
- Transferring a call ..... 37
- Volume, adjusting..... 35
- Wall mounting the base ..... 13
- Warranty..... 70

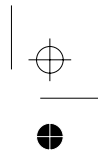
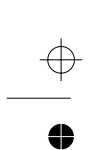

CUT		CUT	
REMOTE OPERATION CARD <b>Uniden®</b>		REMOTE OPERATION CARD <b>Uniden®</b>	
<p><b>Remote access away from home</b></p> <ol style="list-style-type: none"> <li>1. Call your phone number from a touch-tone phone.</li> <li>2. During the outgoing message, press # and enter your PIN code. The answering system announces the number of messages stored in memory and the voice prompts.</li> <li>3. To quit, hang up the phone.</li> </ol>	<p><b>Turn on the answering system remotely</b></p> <ol style="list-style-type: none"> <li>1. Call your phone and let it ring 15 times until you hear a beep.</li> <li>2. Press # and then enter your PIN code.</li> <li>3. Press # then 5 to stop the announcement.</li> <li>4. Press # then 6 to turn the answering system on.</li> </ol>	<p><b>Remote access away from home</b></p> <ol style="list-style-type: none"> <li>1. Call your phone number from a touch-tone phone.</li> <li>2. During the outgoing message, press # and enter your PIN code. The answering system announces the number of messages stored in memory and the voice prompts.</li> <li>3. To quit, hang up the phone.</li> </ol>	<p><b>Turn on the answering system remotely</b></p> <ol style="list-style-type: none"> <li>1. Call your phone and let it ring 15 times until you hear a beep.</li> <li>2. Press # and then enter your PIN code.</li> <li>3. Press # then 5 to stop the announcement.</li> <li>4. Press # then 6 to turn the answering system on.</li> </ol>
CUT		CUT	
REMOTE OPERATION CARD <b>Uniden®</b>		REMOTE OPERATION CARD <b>Uniden®</b>	
<p><b>Remote access away from home</b></p> <ol style="list-style-type: none"> <li>1. Call your phone number from a touch-tone phone.</li> <li>2. During the outgoing message, press # and enter your PIN code. The answering system announces the number of messages stored in memory and the voice prompts.</li> <li>3. To quit, hang up the phone.</li> </ol>	<p><b>Turn on the answering system remotely</b></p> <ol style="list-style-type: none"> <li>1. Call your phone and let it ring 15 times until you hear a beep.</li> <li>2. Press # and then enter your PIN code.</li> <li>3. Press # then 5 to stop the announcement.</li> <li>4. Press # then 6 to turn the answering system on.</li> </ol>	<p><b>Remote access away from home</b></p> <ol style="list-style-type: none"> <li>1. Call your phone number from a touch-tone phone.</li> <li>2. During the outgoing message, press # and enter your PIN code. The answering system announces the number of messages stored in memory and the voice prompts.</li> <li>3. To quit, hang up the phone.</li> </ol>	<p><b>Turn on the answering system remotely</b></p> <ol style="list-style-type: none"> <li>1. Call your phone and let it ring 15 times until you hear a beep.</li> <li>2. Press # and then enter your PIN code.</li> <li>3. Press # then 5 to stop the announcement.</li> <li>4. Press # then 6 to turn the answering system on.</li> </ol>

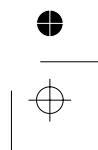
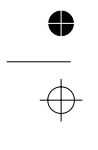

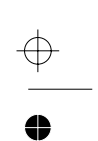
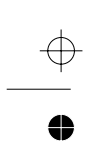

Task	Key
Repeat a Message	# 1
Playing incoming Messages	# 2 (msg)
Skipping a Message	# 3 (msg)
Deleting a Message	# 4 (msg)
Stop Operation	# 5 (st)
Answering System On	# 6 (msg)
Memo Record/Stop	# 7 (msg)
Greeting Message Record/Stop	# 8 (msg)
Answer System Off	# 9 (msg)
Help Guidance	# 0 (msg)

  

Task	Key
Repeat a Message	# 1
Playing incoming Messages	# 2 (msg)
Skipping a Message	# 3 (msg)
Deleting a Message	# 4 (msg)
Stop Operation	# 5 (st)
Answering System On	# 6 (msg)
Memo Record/Stop	# 7 (msg)
Greeting Message Record/Stop	# 8 (msg)
Answer System Off	# 9 (msg)
Help Guidance	# 0 (msg)

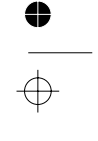
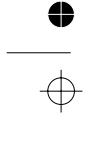

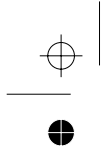

MEMO

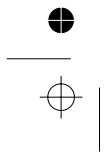
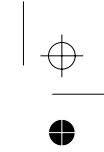

[68]

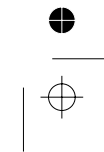

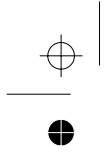

MEMO

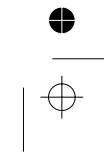
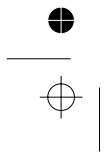
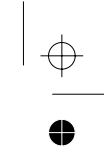



## One Year Limited Warranty

**Important:** Evidence of original purchase is required for warranty service.

**Warrantor:** Uniden Australia Pty Limited A.B.N. 58 001 865 498 Uniden New Zealand Limited  
**Warranty is only valid in the original country of purchase.**

**ELEMENT OF WARRANTY:** Uniden warrants to the original retail owner for the duration of this warranty, its DSS3455/DSS3455+1/DSS3455+2 (herein after referred to as the Product), to be free from defects in materials and craftsmanship with only the limitations or exclusions set out below.

**WARRANTY DURATION:** This warranty to the original retail owner only, shall terminate and be of no further effect 12 months after the date of original retail sale. This warranty will be deemed invalid if the product is;

- (A) Damaged or not maintained as reasonable and necessary,
- (B) Modified, altered or used as part of any conversion kits, subassemblies, or any configurations not sold by Uniden,
- (C) Improperly installed,
- (D) Repaired by someone other than an authorized Uniden Repair Agent for a defect or malfunction covered by this warranty,
- (E) Used in conjunction with any equipment or parts or as part of a system not manufactured by Uniden.

**PARTS COVERED:** This warranty covers for one (1) year, the Base unit and handset (DSS3455) or base, charger and handset (DSS3455+1/DSS3455+2/DSS3435+1). Accessories: AC Adaptor, Batteries, Belt Clips etc are covered for 90 days only.

**STATEMENT OF REMEDY:** In the event that the product does not conform to this warranty at any time while this warranty is in effect, the warrantor at its discretion, will repair the defect or replace the product and return it to you without charge for parts or service.  
**THIS WARRANTY DOES NOT COVER OR PROVIDE FOR THE REIMBURSEMENT OR PAYMENT OF INCIDENTAL OR CONSEQUENTIAL DAMAGES. THIS GUARANTEE IS IN ADDITION TO AND DOES NOT IN ANY WAY AFFECT YOUR RIGHTS UNDER THE CONSUMER GUARANTEE ACT.**

**PROCEDURE FOR OBTAINING PERFORMANCE OR WARRANTY:** In the event that the product does not conform to this warranty, the Product should be shipped or delivered, freight pre-paid, with evidence of original purchase (eg. a copy of the sales docket), to the warrantor at:

### UNIDEN AUSTRALIA PTY LIMITED SERVICE DIVISION

345 Princes Highway,  
Rockdale,  
NSW 2216,  
AUSTRALIA  
Fax: (02) 9599 3278  
www.uniden.com.au

### UNIDEN NEW ZEALAND LIMITED SERVICE DIVISION

150 Harris Road,  
East Tamaki,  
Auckland,  
NEW ZEALAND  
Fax: (09) 274 4253  
www.uniden.co.nz

[70]



**THANK YOU FOR BUYING A UNIDEN PRODUCT.**

**Uniden®**

© 2006 Uniden Australia Pty Limited. Uniden New Zealand Ltd. Printed in China UPZZ01414BZ(0)



## Free Manuals Download Website

<http://myh66.com>

<http://usermanuals.us>

<http://www.somanuals.com>

<http://www.4manuals.cc>

<http://www.manual-lib.com>

<http://www.404manual.com>

<http://www.luxmanual.com>

<http://aubethermostatmanual.com>

Golf course search by state

<http://golfingnear.com>

Email search by domain

<http://emailbydomain.com>

Auto manuals search

<http://auto.somanuals.com>

TV manuals search

<http://tv.somanuals.com>