

**Uniden®**

**DSS7815/DSS7815 +1**

**Series Owners Manual**

**OWNER'S MANUAL**

## Contents

<b>WELCOME/ FEATURES</b>	<b>2</b>	Making Calls Using the Phonebook	40
<b>TERMINOLOGY</b>	<b>3</b>	Speed Dialing	40
<b>CONTROLS &amp; FUNCTIONS</b>	<b>4</b>	Editing or Erasing a Stored Name, Phone Number, Distinctive Ring and Speed Dial	41
<b>DISPLAY AND ICONS</b>	<b>6</b>	Copying Phonebook Locations	42
<b>SOFT KEY FUNCTION</b>	<b>8</b>	<b>CALLER ID</b>	<b>43</b>
<b>GETTING STARTED</b>	<b>9</b>	Caller ID and CIDCW (Caller ID on Call Waiting)	43
Setting up the Phone	9	Viewing the Caller ID List	45
Mounting the Base Unit on a Wall	12	Deleting a Caller ID Message	46
Expanding Your Phone	14	Using the Caller ID Message List	48
Connecting the Charger	14	<b>MULTI- HANDSET FEATURES</b>	<b>50</b>
Register the Handset	15	Multi- Handset Features	50
Main Menu Options	16	Using DirectLink Mode	50
Setting Menu Options	17	3- Way Conferencing	51
<b>BASICS</b>	<b>27</b>	Intercom/ Call Transfer Feature	51
Making and Receiving Calls	27	<b>ADDITIONAL INFORMATION</b>	<b>53</b>
Call Waiting	29	Changing the Digital Security Code	53
Placing a Call on Hold	29	Find Handset	53
Redialing a Call	30	Installing the Beltclip	53
Adjusting the Ringer, Earpiece and Speaker Volume	31	Headset Installation	53
Temporarily Muting the Ringer	31	Note on Power Sources	54
Mute Microphone	32	General Information	56
Tone Dialing Switch-over (Australia only)	32	<b>TROUBLESHOOTING</b>	<b>57</b>
Traveling Out of Range	33	Troubleshooting	57
Privacy Mode	33	Liquid Damage	61
Using One Touch Voice Mail Access	34	<b>MEMORY LIST</b>	<b>60</b>
<b>PHONEBOOK</b>	<b>35</b>	<b>INDEX</b>	<b>63</b>
Phonebook (Storing Phone Numbers, Names, Distinctive Rings and Speed Dial)	35	<b>WARRANTY</b>	<b>66</b>
Chain Dialing	36		
Steps for Entering Names and Special Characters	37		
Viewing the Phonebook	39		

[1]

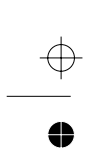

## Welcome

Congratulations on your purchase of the Uniden single (DSS7815) or dual (DSS7815+1) handset cordless phone. This phone is designed and engineered to exacting standards for reliability, long life, and outstanding performance.

**Note:** Some illustrations in this manual may differ from the actual unit for expansion purposes.

## Features

- 5.8GHz Digital Expandable
- 10 Multi- Handset Expandability
- Hands- Free Duplex Speakerphone in the Handset
- Caller ID\*
- 100 programmable Memory Locations
- Intercom/ Call Transfer Between Handsets\*\*
- 20 Distinctive Ring Options (10 ringer tones and 10 melody ringers)\*
- Mute and Hold Features
- Direct Link Mode\*\*
- Room/ Baby Monitoring\*\*
- Battery Level Indicator
- Clock Display
- Animation Displays

\* Requires subscription to Caller ID service provided by Network supplier. There is usually a fee for this service.

\*\* Requires the use of multiple handsets.

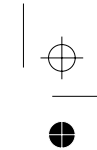
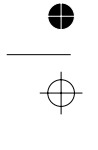

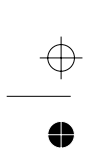

This series features **AutoTalk** and **AutoStandby**. AutoTalk allows you to answer a call by just removing the handset from the cradle so you don't have to waste time pushing buttons. Auto Standby allows you to hang up by simply returning the handset to the cradle.

To protect you against mis-billed calls that might result from your phone being activated by other equipment, this series has **Random Code** digital security, which automatically selects one of more than 10,000,000 digital security codes for the handset and base. Digital Spread Spectrum Technology uses a wider frequency band than standard digital transmissions. The result is a more secure conversation with the clarity of digital sound, extended range, and minimal interference from other cordless phones.

**IntegriSound** Built in sound quality which provides life-like conversations.

With **DirectLink** mode, you can use 2 or more handsets as radio transceivers (walkie-talkies). Be sure to visit our web site: [www.uniden.com.au](http://www.uniden.com.au) or [www.uniden.co.nz](http://www.uniden.co.nz)

## Terminology

- **Standby Mode** - The handset is not in use, and **talk/flash** or **speaker** has not been pressed. No dial tone is present.
- **Talk Mode** - The hand set is not in the cradle, and **talk/flash** or **speaker** has been pressed, enabling a dial tone. Talk appears on the display.

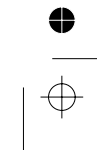
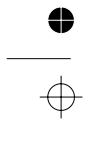

## Controls & Functions

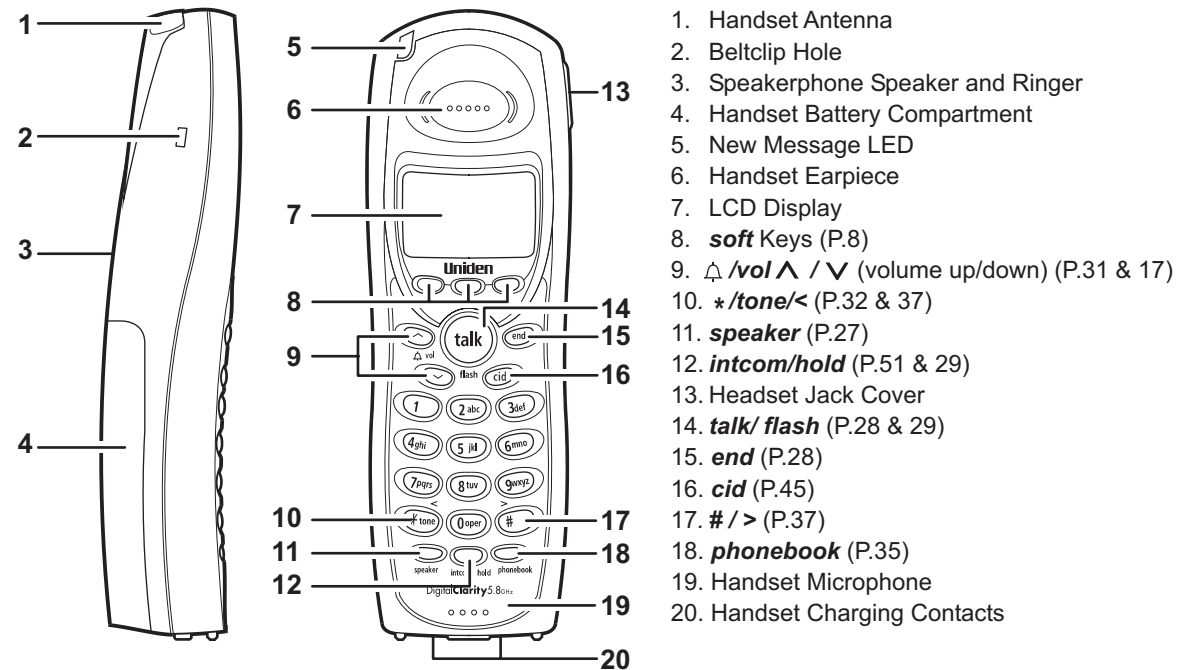

[4]

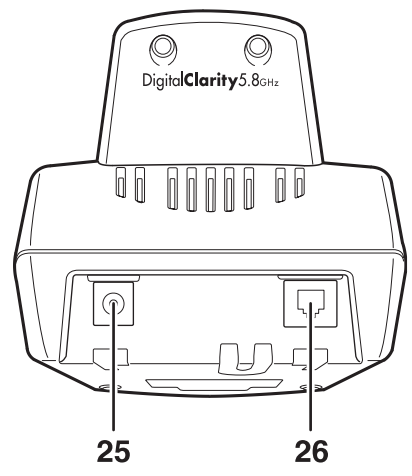
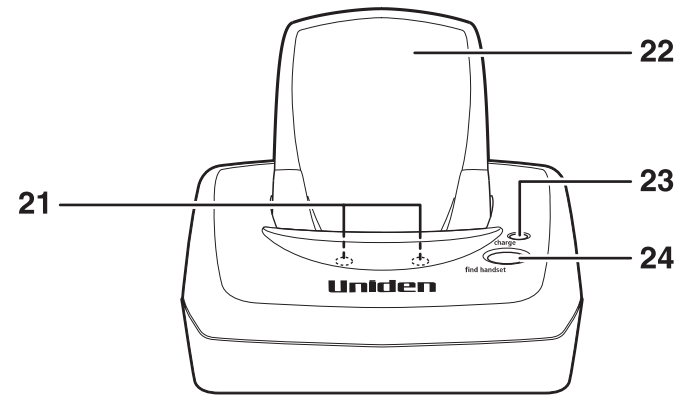
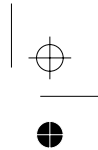



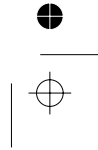
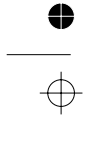



- 21. Base Charging Contacts
- 22. Base Antenna
- 23. Charge LED
- 24. ***find handset*** (P.53)
- 25. **DC IN 9V** Jack
- 26. **TEL LINE** Jack

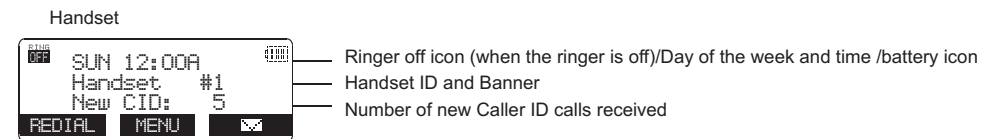

## Display and Icons

Example of the standby mode display



ICON	Appears During	DESCRIPTION
	Standby/Talk	<b>Battery</b> icons indicate the handset battery status. This icon cycles depending on the battery status (full, medium, low, and empty).
	Standby	<b>Ringer</b> off icon indicates that ringer is turned off.
	Talk	The <b>Mute</b> icon appears when you mute the handset.
	Talk speaker phone	The <b>Speaker</b> icon appears when the handset is used.
	Talk	The <b>Privacy</b> icon appears when the Privacy Mode is turned on.

## Animation Displays

The handsets have a variety of animation displays. Below are examples of the animation screens and what they mean:

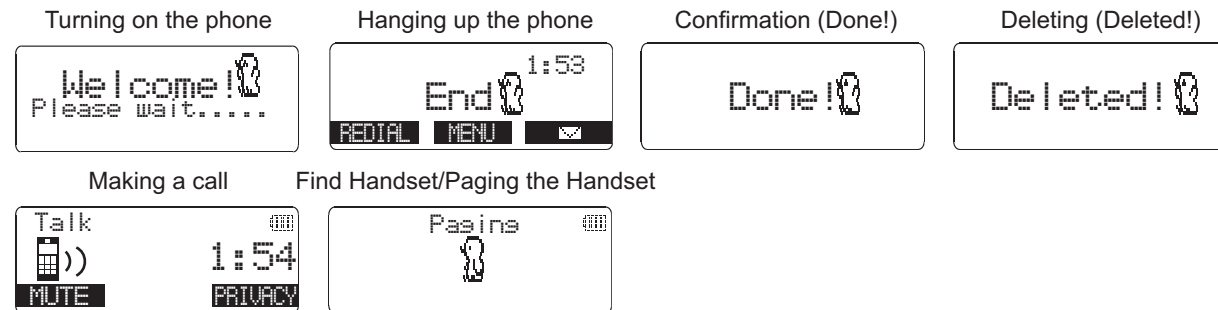

Also, the animation display changes depending on the ringer volume setting.

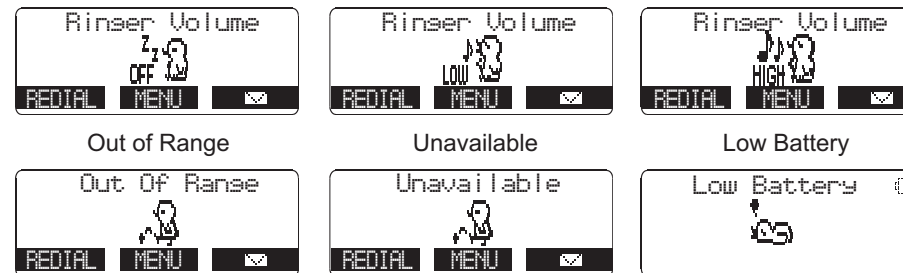



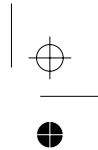
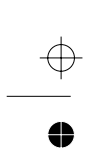

## Soft Key Function

"Soft" keys are keys that change function during the operation of the phone. There are three soft keys on each handset.

### Soft Keys allow you to:

- Access the main menu
- Set up CIDCW options
- Store or edit phone numbers
- Access stored Caller ID messages
- Redial one of the last three numbers dialed from the handset
- Access Voice mail waiting

**Note:** The soft keys will not appear while the handsets charging.

The function of each soft key is determined by the icon that appears directly above it. For example, when the handset is in standby mode, pressing soft key 1 will redial the last dialed number. When the handset is in talk mode, pressing soft key 1 will mute the microphone.

Complete information on the features controlled by the soft keys can be found under each feature.

### In standby mode

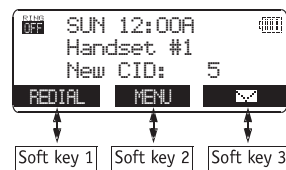

### In talk mode

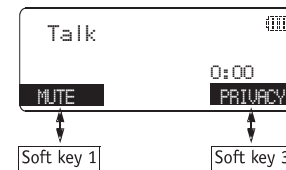

[8]

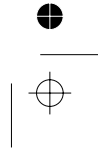
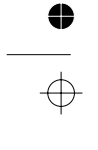

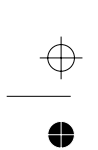

note

**For maximum range:**

- Keep the antenna free of obstruction.
- When the handset is not in use place the handset in an upright position.
- Do not hold the handset where you would block the signal.

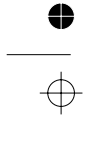
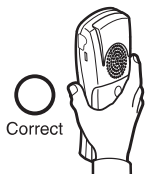

## Setting up the Phone

### Do the following steps:

- Choose the best location
- Connect the base unit
- Install the rechargeable battery pack into the handset
- Connect the charger
- Mount the base unit on a wall

### A. Choose the best location

Here are some important guidelines you should consider:

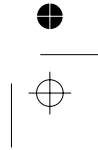
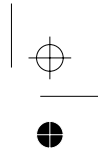
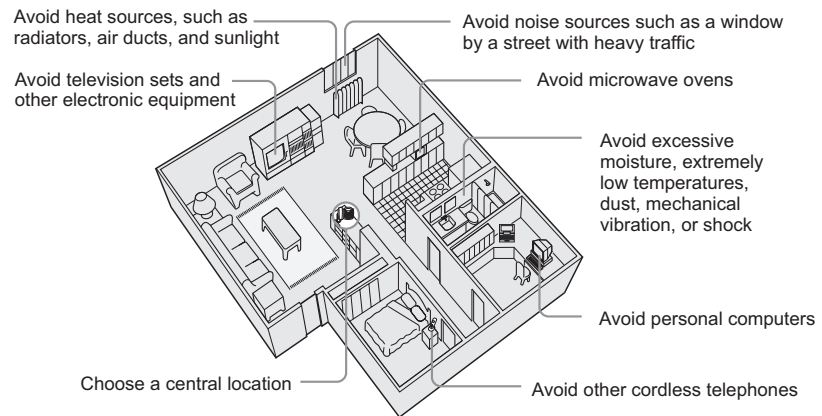

## B. Connect the base unit

- 1) Connect the AC adapter to the **DC IN 9V** jack and to a standard 240VAC wall outlet. Connect the AC adapter to a continuous power supply (i.e., an outlet that is not controlled by a switch).
- 2) Set the base on a desk or tabletop, and place the handset in the base unit. Place the base unit close to the AC outlet so that you can unplug the AC adapter easily.
- 3) Make sure that the charge LED illuminates. If the LED does not illuminate, check to see that the AC adapter is plugged in and the handset makes good contact with the base charging contacts.
- 4) After install the battery pack in the handset, charge your handset for at least 15-20 hours before plugging into the phone line.
- 5) Once the handset battery pack is fully charged, connect the telephone line cord to the **TEL LINE** jack and to a telephone outlet. If your telephone outlet isn't modular, contact your telephone company for assistance.

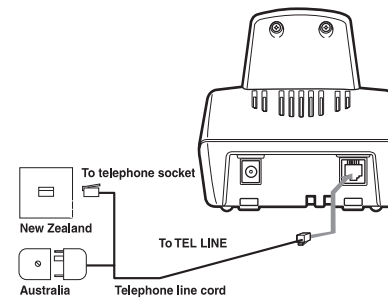
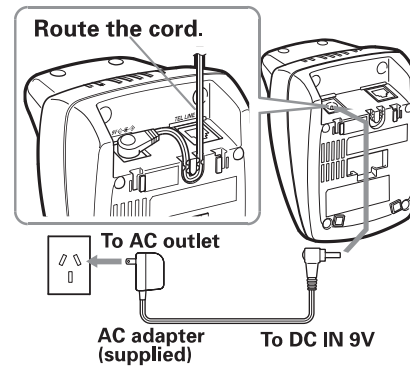

[10]

### note

- Use only the supplied [AAD-041S] AC adapter. Do not use any other AC adapter.
- Do not place the power cord where it creates a trip hazard or where it could become chafed and create a fire or electrical hazard.

GETTING STARTED

## note

- Use only the Uniden (BT-446) rechargeable battery pack supplied with your cordless telephone.
- Replacement battery packs are available. See our website for information.  
[www.uniden.com.au](http://www.uniden.com.au)  
[www.uniden.co.nz](http://www.uniden.co.nz)

### C. Install the rechargeable battery pack into the handset

The handset is powered by a rechargeable battery pack. The battery recharges automatically when the handset is placed in the base unit. To maximize the charge capacity of your battery pack, DO NOT plug the telephone cord into the base unit and wall jack until the battery is fully charged.

- 1) Press down on the handset battery case cover (use the finger indentation for a better grip) and slide the cover downward to remove.
- 2) Turn the battery pack so that the connector with the red and black wires is near the jack inside the battery compartment. Match the connector's wire colors to the polarity label in the battery compartment (the connector notches fit into the grooves of the jack only one way). Push the battery pack connector into the jack until it clicks into place.
- 3) Make sure you have a good connection by gently pulling on the battery wires. If the connection is secure, the battery jack will remain in place.
- 4) Place the battery case cover back on the handset and slide it upwards until it clicks into place.

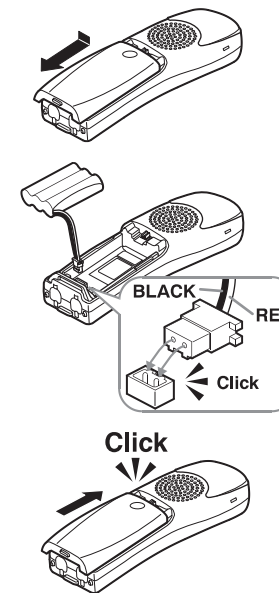

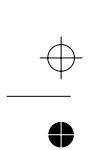

## Mounting the Base Unit on a Wall

### Standard wall plate mounting

This phone can be mounted on any standard wall plate.

- 1) Make the AC adapter and the telephone line cord through the hole on the wall mount adapter.
- 2) Plug the AC adapter into the **DC IN 9V** jack.
- 3) Plug the telephone line cord into the **TEL LINE** jack.
- 4) Slide the wall mount adapter into the notches on the base.
- 5) Plug the AC adapter into a standard **240V AC** wall outlet. Hook the cord on the notch of the wall mount adapter.
- 6) Plug the telephone line cord into the telephone outlet. Hook the cord on the notch of the wall mount adapter.
- 7) Align the mounting slots on the base with the mounting posts on the wall. Then push in and down until the phone is firmly seated. To remove, push up a tab on the wall mount adapter as shown.

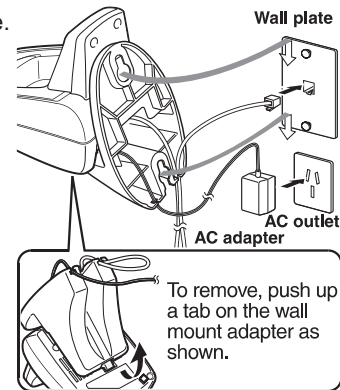
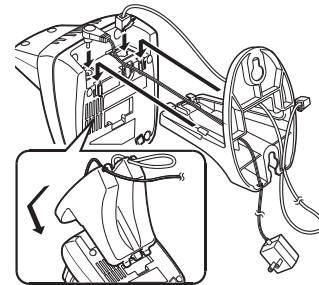

[12]

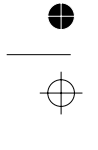



### Direct wall mounting

If you don't have a standard wall plate, you can mount your phone directly to the wall. Before doing this, consider the following:

- Avoid electrical cables, pipes, or other items behind the mounting location that could cause a hazard when inserting screws into the wall.
- Try to mount your phone within 1.5m of a working phone jack to avoid excessive lengths.
- Make sure the wall material is capable of supporting the weight of the base and handset.
- Use #10 screws (minimum length of 35mm) with anchoring devices suitable for the wall material where the base unit will be placed.

- 1) Insert two mounting screws into the wall (with their appropriate anchors). 100mm apart. Allow about 3mm between the wall and screw heads for mounting the phone.
- 2) Refer to steps 1 through 7 on page 12 to mount the telephone.

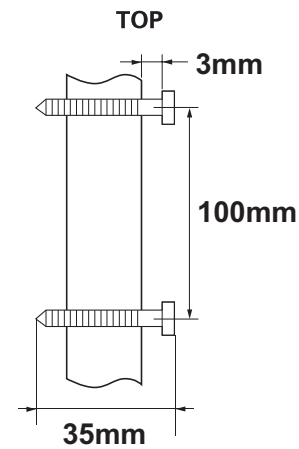

[13]

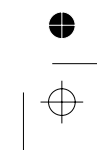
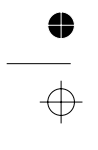

## Expanding Your Phone

### 10 Handsets Expandability

Your phone supports up to 10 handsets, including any handsets supplied with your phone. You can now place a fully-featured cordless handset anywhere AC power is available to connect the handset charger. Up to 2 handsets can be used in DirectLink Mode or on an intercom call without interfering with incoming calls. If possible to have a 3-way conference among 2 handsets and an outside line. All of handsets ring when a call is received.

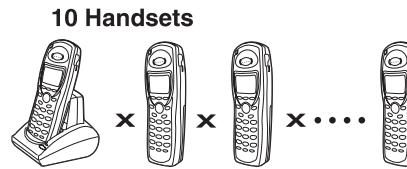

**IMPORTANT:** If you purchase a DSS7805 extra handset, please register the handset to the original/main base before use. The DSS7805 will not operate until it is registered. If you change a global setting in one handset, you change that particular setting for all registered handsets. All other settings (not included under Global Setup) must be set separately through each handset.

### Connecting the Charger

- 1) Connect the AC adapter to the **DCIN9V** jack and to a standard **240VAC** wall outlet.
- 2) Set the charger on a desk or tabletop, and place the handset in the charger with the keypad facing forward. (See "C. Install the rechargeable battery pack into the handset" on page 11).

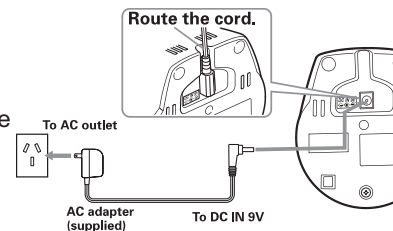

[14]



- Charge the handset battery pack for at least 15-20 hours before using your new cordless telephone for the first time.

GETTING STARTED

**note**

- An extra handset can be registered when the main base is in standby mode.
- If you have purchased the DSS7815+1 your extra handset would have been pre-registered at factory as handset 2.

**Register the Handset**

If you purchase an extra handset, you need to register the handset before use. Only one handset can be registered at a time.

Handsets supplied with the phone are registered to the base by the factory. When charged, pre-registered handsets display a handset ID number. Handsets that have not been registered display *Place handset on main base to register*. When you register an extra handset to the base, the handset ID will be assigned.

Place handset on main base to register

- 1) Before registering the extra handset, the battery pack **MUST** be charged for 15-20 hours.
- 2) Place the extra handset in the main base unit to begin registration.
- 3) While the handset is registering, *Handset Registering* will appear in the LCD. When *Registration Complete* is displayed, the handset has been registered to the base. If *Registration Failed* appears, please try these steps again.

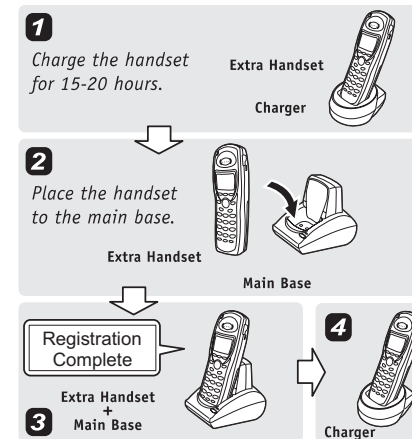



## Main Menu Options

Your phone has five main menu options: **DirectLink Mode, Room/Baby Monitor, Handset Setup, Global Setup** and **Deregister HS**.

### Default Settings

The default settings set from the factory match the features that most people use. You may not need to change them. However, there are a number of options you must set and entries you must make in memory to take full advantage of all the phone features. The table below lists the default settings.

Function	Default Settings	Function	Default Settings
Edit Voice Mail	None(Aus)/ 083210(NZ)	Day & Time	SUN 12:00 AM
Ringer Tone	Flicker	CIDCW	Off
Distinctive Ring	On	Dial Mode	Tone
Auto Talk	On	Insert O	On (NZ)/Off (AUS)
Anykey Answer	On	Name Tagging	On
Banner	“ “		
Contrast	level 5		
Key touch tone	On		
Animation Screen	On		



- For Global Setup and Deregister HS menu options, make sure the line is not in use and the handsets are within range of the base.
- Main menu flow chart is provided on page 64.

GETTING STARTED



- You must have at least two handsets to use Direct Link Mode.

## Setting Menu Options

### Using the interface

Below are some tips for using the software interface on your phone.

- Press the **MENU** soft key to access the main menu.
- Use  $\Delta$ /**vol**/ $\wedge$  and  $\Delta$ /**vol**/ $\vee$  to scroll through options.
- Press the **OK** soft key to make a selection.
- Press the **BACK** soft key to return to the previous screen.
- Press **end** to exit the menu.



### DirectLink Mode

In DirectLink mode, a pair of handsets can function as two-way radios. DirectLink Mode allows two handsets to communicate with each other without the base unit or a telephone line. Use them at sporting events or while shopping to stay in contact with family members or friends. You must set both handsets to DirectLink Mode to activate this feature.

### Using DirectLink Mode

- 1) Press the **MENU** soft key and select the DirectLink Mode menu. To enter DirectLink mode press [ENTER] appears.
- 2) Press the **ENTER** soft key to enter DirectLink mode. You will hear a confirmation tone, and DirectLink Mode Complete appears.
- 3) To return to normal mode, press the **CANCEL** soft key and then the **OK** soft key, or return the handset to the cradle.

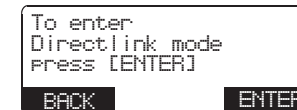

## Room/Baby Monitor

This feature allows you to monitor sounds in another room. Place a handset in the room you wish to monitor; it will function as a microphone. A second handset can be set to function as a remote speaker, allowing you to monitor sounds in the room.

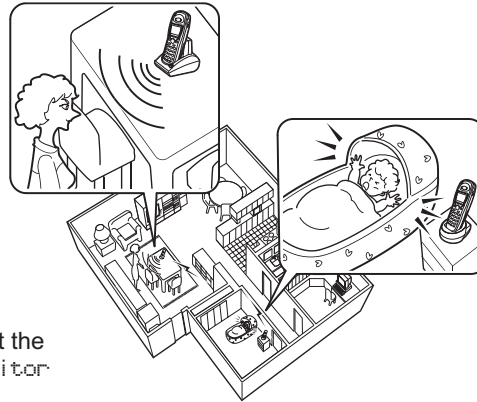

### Using Room/Baby Monitor

- 1) Press the **MENU** soft key and select the Room Monitor menu. To Room Monitor appears.
- 2) Select the handset you want to monitor by using  $\Delta$  /vol/ ^ or  $\Delta$  /vol/ v .
- 3) Press the **OK** soft key. Room Monitor appears, and you hear sounds in the room where the handset is installed.
- 4) To turn off the Room Monitor, press the **END** soft key, or *end*.



[18]



- This feature only works when the handset(s) is within the range of the base.
- You must have at least two handsets to use Room/Baby Monitor.

GETTING STARTED

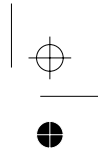
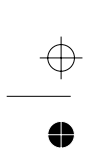

## Handset Setup

The following submenu options must be set separately for each handset.

### Programming your Voice Mail Access Number

- 1) Press the **MENU** soft key. Select the Handset Setup menu, and then the Edit Voice Mail submenu. Edit V\_mail No. appears.
- 2) Enter your personal access number using the number keypad (09), *\*tone/<,>*, the **DELETE** soft key, or the **PAUSE** soft key (up to 20 digits).
- 3) Press the **OK** soft key. You will hear the confirmation tone. To delete the current Voice Mail Access Number, delete all numbers in step 2 using the **DELETE** soft key and the **OK** soft key.

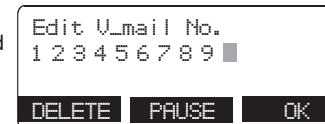

### Selecting a Ringer Tone

Ringer Tone lets you choose from 10 ringer tones or 10 melodies:

- **Ringers** (Flicker, Clatter, Soft Alert, Wake Up, Light Bug, Beep Boop, Tone Board, Chip Chop, Party Clap, Reminder)
- **Melodies** (Beethoven's Symphony #9 [Beethoven9], For Elise [Elise], We Wish You A Merry Christmas [Merry-Xmas], Home Sweet Home [Hm Swt Hm], Lorri Song #6 [Lorri Song], When Irish Eyes Are Smiling [Irish Eyes], Aura Lee, Let Me Call You Sweet Heart [Sweet heart], Waltzing Matilda[W Matilda], Old MacDonald [Old MacDld])

You must set the separate ringer tone on each handset.

- 1) Press the **MENU** soft key. Select the Handset Setup menu, and then the Ringer Tone submenu.
- 2) Press **▲ /vol/▲** or **▼ /vol/▼** to move the pointer. You will hear the ringer or melody as you scroll through the options.
- 3) When you reach the ringer tone you want, press the **OK** soft key. You will hear a confirmation tone.

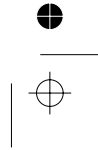
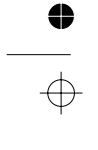
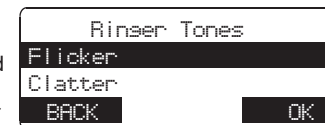

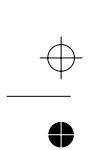

### Distinctive Ringer Setup

Distinctive Ringer allows you to assign a designated ring tone to a stored phonebook number (100 stored locations available). When a call is received and the Caller ID information matches the information in one of the phonebook memory locations, the phone uses the distinctive ring assigned to that particular Caller. You can assign distinctive rings to multiple phonebook memory locations. Switching the setting to Distinctive Off disables distinctive ringing: all incoming calls will have normal ring tone. Switching to Distinctive On activates all programmed distinctive ring memory locations.

- 1) Press the **MENU** soft key. Select the Handset Setup menu, and then the Distinctive Ring submenu.
- 2) Press  $\Delta$  /vol/  $\wedge$  or  $\Delta$  /vol/  $\vee$  to select On or Off.
- 3) Press the **OK** soft key. You will hear a confirmation tone.



### Setting the Autotalk

Autotalk allows you to answer the phone simply by removing the handset from the cradle. You do not have to push any buttons to answer the call.

- 1) Press the **MENU** soft key. Select the Handset Setup menu, and then the Autotalk submenu.
- 2) Press  $\Delta$  /vol/  $\wedge$  or  $\Delta$  /vol/  $\vee$  to select On or Off.
- 3) Press the **OK** soft key. You will hear a confirmation tone.



### Setting Anykey Answer

Anykey Answer allows you to answer the phone by pressing any number key, \* /tone/  $\leftarrow$  or # /  $\rightarrow$  on the handset.

- 1) Press **menu/del**. Select the Handset Setup Menu, and then the Anykey Answer submenu.
- 2) Press  $\Delta$  /vol/  $\wedge$  or  $\Delta$  /vol/  $\vee$  to select On or Off.
- 3) Press the **OK** soft key. You will hear a confirmation tone.

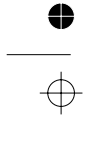
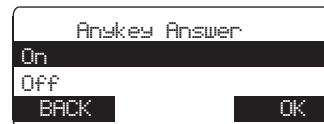

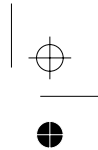

### Setting the True Banner

True Banner lets you customize the name your handset displays. The name will be displayed on the LCD screen during Standby Mode, Intercom, Intercom Hold, Room Monitor, and Copy Phonebook operation. The banner name will be displayed on the receiving handset as well.

- 1) Press the **MENU** soft key. Select the Handset Setup menu, and then the Banner submenu.
- 2) Use the number keypad (0-9), \* /tone/ ← , #/ → , Or **DELETE** to enter or edit the name.
- 3) Press the **OK** soft key. You will hear a confirmation tone.



### Adjusting the LCD Contrast

Contrast adjusts the Handset LCD brightness. Choose one of the ten levels for optimum viewing.

- 1) Press the **MENU** soft key. Select the Handset Setup menu, and then the Contrast submenu.
- 2) Press **▲ /vol/▲** or **▼ /vol/▼** to adjust the contrast of the LCD (ten levels).
- 3) Press the **OK** soft key. You will hear a confirmation tone.

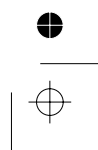
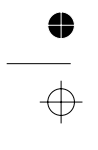

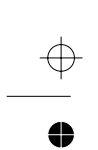

### Setting the Key Touch Tone

Key Touch Tone is the tone your keypad makes when keys are pressed. You can turn this tone on or off.

- 1) Press the **MENU** soft key.  
Select the Handset Setup menu, and then the Key Touch Tone submenu.
- 2) Press  $\Delta$  /vol/  $\wedge$  or  $\Delta$  /vol/  $\vee$  to select On or Off
- 3) Press the **OK** soft key.  
You will hear a confirmation tone.



### Setting the Animation Screen

The Animation screen displays animation on the handset LCD. The animations will be displayed on the LCD screen during a call, ringer volume setting, when you hang up, and so on.

- 1) Press the **MENU** soft key. Select the Handset Setup menu and then the Animation Screen submenu.
- 2) Press  $\Delta$  /vol/  $\wedge$  or  $\Delta$  /vol/  $\vee$  to select On or Off.
- 3) Press the **OK** soft key. You will hear a confirmation tone. See "Animation Displays" on page 7 for all the available screens.

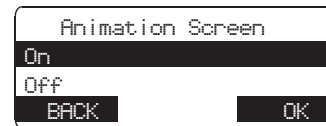

[22]

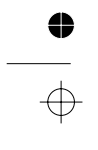



- For setting the Day and Time, the idle time-outs extended to 2 minutes.

- Caller ID on Call Waiting is currently unavailable in New Zealand.

## Global Setup

If you change one of the global settings, you change that setting for all registered handsets and the base. Only one handset or the base can change global settings at a time.

### Setting Day and Time

Day & Time sets the day and time of your display.

- 1) Press **MENU** soft key. Select the Global Setup menu, and then the Day & Time submenu option.
- 2) Press  $\Delta$  /vol/  $\wedge$  or  $\Delta$  /vol/  $\vee$  to select the day of the week, and then the  $\rightarrow$  soft key.
- 3) Press  $\Delta$  /vol/  $\wedge$  or  $\Delta$  /vol/  $\vee$  to set hour, and then the  $\rightarrow$  soft key
- 4) Press  $\Delta$  /vol/  $\wedge$  or  $\Delta$  /vol/  $\vee$  to set minute, and then the  $\rightarrow$  soft key
- 5) Press  $\Delta$  /vol/  $\wedge$  or  $\Delta$  /vol/  $\vee$  to choose AM or PM, and then the **SAVE** soft key. You will hear a confirmation tone.



### Setting Caller ID on Call Waiting (CIDCW)

Caller ID on Call Waiting (CIDCW) displays the name and number of an incoming call while you are on the line.

- 1) Press the **MENU** soft key. Select the Global Setup menu, and then the CIDCW submenu.
- 2) Press  $\Delta$  /vol/  $\wedge$  or  $\Delta$  /vol/  $\vee$  to select On or Off.
- 3) Press the **OK** soft key. You will hear a confirmation tone.





### Setting the Dial Mode (Australia Only)

Dial Mode sets the dial mode to tone or pulse. Most phone systems use tone dialing; the default setting is tone dialing. Set the dialing mode to match the dialing system used by your local phone service.

- If you are not sure of your dialing system, make a trial call. If the call connects, leave the setting as is; otherwise set the unit to pulse dialing.
- If your phone system requires pulse dialing and you need to send DTMF tones in certain situations during a call, you may switch over to tone dialing (refer to "Tone Dialing Switch-over" on page 32).

- 1) Press the **MENU** soft key. Select the Global Setup menu, and then the Dial Mode submenu.
- 2) Press  $\Delta$  /vol/  $\wedge$  or  $\Delta$  /vol/  $\vee$  to select Tone or Pulse (the initial setting is Tone).
- 3) Press the **OK** soft key. You will hear a confirmation tone.

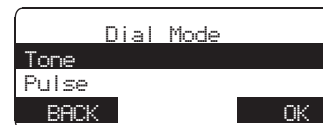

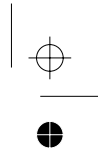
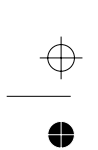

### Setting Name Tag

The Name Tag feature works with the Caller Display number from Caller ID. A subscription to this service is required from your network provider. There is usually a fee for this service. When the phone rings the caller display number, when received will be compared to numbers stored in the phonebook. If there is a match any name stored with the phonebook number will be displayed.

1) Press the **MENU** soft key. Select the Global Setup menu, and then the Name Tag submenu.

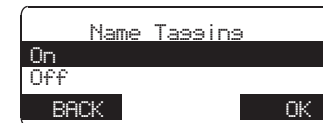

2) Press  $\Delta$  /vol/^ or  $\Delta$  /vol/v to select On or Off (the initial setting is On).

3) Press the **OK** soft key.  
You will hear a confirmation tone.

### Setting the Insert Zero

This feature adds '0' or '00' to the number, when you receive Caller ID messages. The default setting for New Zealand is On. The default setting for Australia is Off.

1) Press **MENU** soft key. Select the Global Setup menu, and then the Insert 0 submenu.

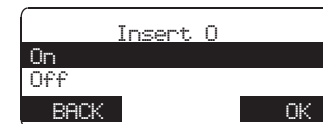

2) Press  $\Delta$  /vol/^ or  $\Delta$  /vol/v to select On or Off.

3) Press the **OK** soft key.  
You will hear a confirmation tone.

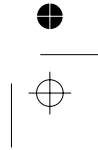
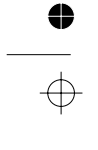

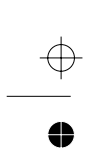

### De-register the Handset

- 1) In standby mode, select Deregister HS in the menu and press the **OK** soft key.  
De register HS? appears.
- 2) Press **▲/vol/ ^** or **▲/vol/ v** to select Yes, and then the OK soft key. When de-registration is complete you will hear a confirmation tone and De-registration Complete appears.
- 3) After de-registering the handset, place the handset to the base to register. You must re-register the handset before you can use it.

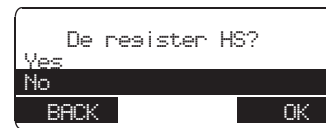

[26]

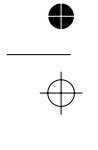

## note

- For best performance talk alternately with the caller in a quiet room. You can decrease the speaker volume if you or the other party has difficulty hearing

## Making and Receiving Calls

With the handset's duplex speakerphone, you can have hands-free conversations.

The  icon appears on the display screen during hands-free conversations.

You can easily switch a call from normal conversation to hands-free conversation. To switch a call, press **speaker** during the call.

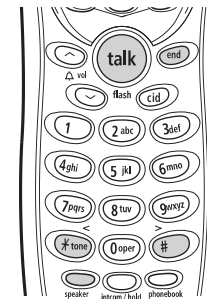

From the handset

	From the Handset	
	Normal conversation	Hands-free conversation
<b>To answer a call</b>	<p><b>Handset On the Cradle</b> Pickup the handset (AutoTalk is: on) or pick up the handset and press <b>talk/flash</b> (AutoTalk is: off).</p> <p><b>Handset Off the Cradle</b> Press any number key, <b>*/tone/</b>&lt;, or <b>#/</b>&gt;(Any Key Answer), or press <b>talk/flash</b>.</p>	<p><b>Handset Off the Cradle</b> Press <b>speaker</b>.</p>
<b>To make a call</b>	<p><b>Handset Off the Cradle</b> 1) Press <b>talk/flash</b>. 2) Listen for the dial tone. 3) Dial the number. OR Dial the number, and then press <b>talk/flash</b>.</p>	<p><b>Handset Off the Cradle</b> 1) Press <b>speaker</b>. 2) Listen for the dial tone. 3) Dial the number. OR Dial the number, and then press <b>speaker</b>.</p>
<b>To hang up</b>	Press <b>end</b> or return the handset to the cradle (AutoStandby).	
<b>To enter a pause within the dialing sequence</b>	When you dial the number in standby mode, press the <b>PAUSE</b> soft key. P appears in the display, which represents a pause.	



- To set "Autotalk", see page 20 or to set "Anykey Answer" see page 20.
- The handset microphone is located at the bottom of the handset. (see "Controls and Functions" on page 4). Position yourself as near to the handset as possible and speak clearly.
- If the line is in use by another handset(s), "Line In Use" appears in the display of all registered handsets that are not in use.



### note

- You must subscribe through your local telephone company to receive Call Waiting or Caller ID on call waiting service.
- While a call is on hold, CIDCW can not be received.

## Call Waiting

If you have Call Waiting service and a call waiting tone sounds while you are on a call:

### AUSTRALIA:

Press **talk/flash** then **2** to switch between callers.

### NEW ZEALAND:

Press **talk/flash** to switch between callers.

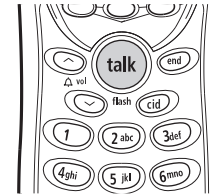

## Placing a Call on Hold

You can place a call on hold for 5 minutes. When 5 minutes has passed the call is disconnected

- 1) During a call, press **intcom/hold**.  
The call will be put on hold.

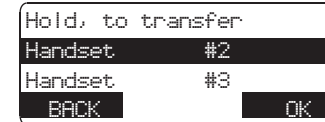

### tip

If you leave a call on hold for more than ten seconds, the display screen will read, Line On Hold

- 2) To talk to the caller press **talk/flash** or **speaker** on a handset. The phone will return back to the call.

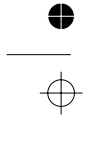



## Redialing a Call

The last three phone numbers dialed can be quickly redialed from the handset. Redial numbers stored in the handset are independent from each other.

### Redialing from Standby Mode

- 1) Press the **REDIAL** soft key.
- 2) Press  $\Delta$  /vol/ ^ or  $\Delta$  /vol/ v to scroll through the last three numbers dialed.
- 3) Press **talk/flash** or **speaker** on the handset. The selected number is dialed.
- 4) To hang up, press **end**.

### Deleting a Redial Record

- 1) With the phone in standby mode, press the **REDIAL** soft key.
- 2) Press  $\Delta$  /vol/ ^ or  $\Delta$  /vol/ v to display the number to be deleted.
- 3) Press the **DELETE** soft key.
- 4) Press  $\Delta$  /vol/ ^ or  $\Delta$  /vol/ v to choose **Yes**.
- 5) Press the **OK** soft key. The redialed number is deleted.

### Storing a Redial Record

- 1) With the phone in standby mode, press the **REDIAL** soft key.
- 2) Press  $\Delta$  /vol/ ^ or  $\Delta$  /vol/ v repeatedly to display the number to be stored.
- 3) Press the **STORE** key. Store/Edit Name appears.
- 4) To complete the setting, follow the steps 3-8 in "Phonebook (Storing Phone Numbers, Names, Distinctive Rings, and Speed dial)" on page 35.

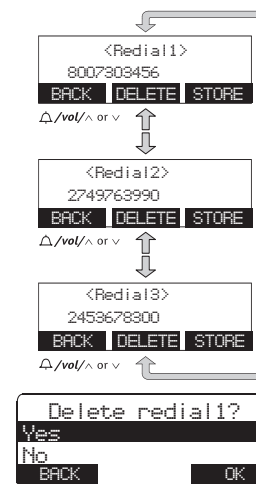

note

- If the number exceeds 32 digits, only the first 32 digits are retained in redial memory.
- If the redial memory is empty, you will hear a beep.

BASICS





- While charging the handset you cannot mute the ringer tone for the handset.

## Adjusting the Ringer, Earpiece and Speaker Volume

### Ringer volume

In standby mode press  $\Delta$ /vol/^ or  $\Delta$ /vol/∨ on the handset to select one of three ringer volumes (**Off, Low or High**)

### Earpiece and Speaker Volume

You can select earpiece volume from among four volume levels on the handset earpiece and six levels on the handset speaker. Pressing the volume up key or volume down key on the handset during a call will change the earpiece or speaker volume. This setting will remain in effect after the telephone call has ended.

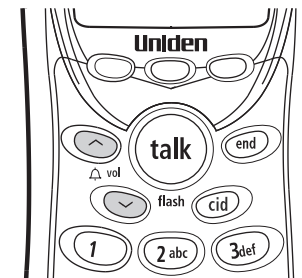

If you press the volume up key when the earpiece is at the maximum volume level, an error tone sounds. The error tone also sounds if you press the volume down key at the lowest volume.

### Temporarily Muting the Ringer

To mute the ringer tone temporarily for each handset, while the phone is ringing, press the **MUTE** soft key on the handset you want to mute. The mute will last for the current incoming call only. The ringer tone will return to the previous setting starting with the next incoming call.



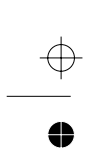

## Mute Microphone

You can temporarily mute the microphone so that the caller cannot hear you.

- 1) Press the **MUTE** soft key during talk mode (while the phone is in use) to mute the microphone
- 2) **Mute On** and  appear in the display. To cancel muting, repeat above step again when Mute is set to on, **Mute Off** appears.



## Tone Dialing Switch-over (Australia only)

If your telephone company requires pulse dialing, you can switchover to tone dialing after the call connects. This feature is useful when you need tone dialing to use any automated menu systems, such as telephone bank tellers, telephone prescription refills, customer support menus, etc.

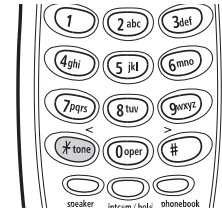

If your phone is set to pulse dialing mode, make your call normally. Once your call connects, press the **\*tone/←** key. Any digits you enter from then on will be sent as tone digits. When this particular call ends, the phone automatically returns to pulse dialing mode.

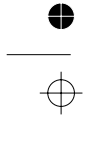

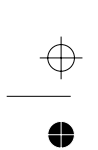

- You can only mute the handset ringer if the handset is off the cradle when the phone starts ringing.

## Traveling Out of Range

During a call, as you begin to move your handset too far from your base unit, noise may increase. If you pass the range limits of the base unit, you will hear a beep and see **Out of Range** on the display, and then the handset returns to standby mode. You may return to the call if you move your handset within the range limits of the base and press **talk/flash** or **speaker** within 30 seconds

## Privacy Mode

Privacy Mode prevents interruption from other registered handsets or the base. This works only when the phone is in use.

Press the **PRIVACY** soft key *on the handset during talk mode*. **Privacy Mode On** and  appear in the display. To exit the Privacy Mode, repeat above step again. **Privacy Mode Off** appears.

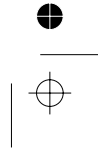
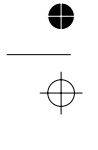

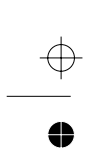



### Using One Touch Voice Mail Access

If you subscribe to voice mail service, you can use your phone to access your voice mailbox. The new message LED flashes whenever you have messages waiting in your voice mailbox. Just program the handset with your access number, and you can get your messages at the touch of a button on the handset. (The voice mail service provider will supply you with the access number. This number may be simply a phone number. Refer to the provider's literature.)

To program or delete your Voice Mail Access Number, See page 19.

### Dialing your Voice Mail Service

Once you've programmed your personal access number, you can dial your mailbox with the touch of a button. When you have messages, simply press the  soft key. If you have not entered the access number or it has been deleted, when you press the  soft key, No Number Stored To store number press [MENU] appears and you will hear a beep. The phone returns to standby mode.

### Resetting the New Message LED

The LED flashes when you have new messages in the voice mail service. If the LED remains on after you've retrieved your messages, you may need to reset the indicators. With the phone is in standby mode, press and hold find handset on the base until the paging sound stops (about 5 seconds).

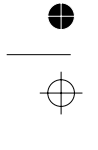

- You must subscribe to voice mail service from your telephone company in order to use this feature. The voice mail service company will provide you with the access number.
- For New Zealand: The Telecom Voice Mail Access Number is pre-programmed into speed dial location 4.



note

- When the memory is full, you will hear a beep and **Memory Full** appears. You cannot store names and numbers.
- The pause key counts as one digit. Pressing **PAUSE** soft key more than once increases the length of the pause between numbers. Each pause represents a 2 second delay.

### Phonebook(Storing Phone Numbers, Names, Distinctive Rings, and Speed Dial)

You can store names and numbers in your phone's phonebook, search for names Alphabetically, and dial phonebook entries with just a few key presses. Phonebook memory is stored independently in the base and handsets. You can store up to 100 numbers in the base and in each handset.

The phone uses the same memory locations to store phonebook entries and Caller ID messages. Any empty phonebook locations are used to store Caller ID messages. For example, if you have stored 100 phonebook entries on your base unit, the base unit will not store Caller ID messages.

1) When the phone is in standby mode, press **phonebook** .  
The following items appear.

- (1st Line) The number of the phone book locations used
- (2nd Line) How to search (press the number keypad, **△/vol/ ^ or △ /vol/ ∨**)
- (3rd Line) How to store (Press the STORE soft key)
- (4th Line) The **BACK, COPY** and **STORE** soft keys.



2) Press the **STORE** soft key. **Store/Edit Name** appears



3) Enter the name (up to 16 characters) by using the number keypad (see "Steps for entering Names and Special Characters" on page 37. If a name is not required, go to step 4. <No Name> will be used as the name.

- 4) Press **OK** soft key to store the name; Store/Edit No. appears.
- 5) Use the number keypad, **\*/tone/ or #/←** to enter the phone number (up to 20 digits). If you make an error, use the **DELETE** soft key to erase the incorrect digits. When you are finished, press the **OK** soft key to store the number.
- 6) Distinctive Rings appears. Press **▲/vol/▲** or **▲/vol** to move the pointer to one of the Distinctive Ring options and then press the **OK** soft key.
- 7) Speed Dial appears. Press **▲/vol/▲** or **▲/vol ▼** to move the pointer to select the Speed dial location (10 locations: SPD1-SPD0).
- 8) Press the **OK** soft key. You will hear a confirmation tone, and Done! appears in the display.

### Chain Dialing

The memory locations in the handset are not limited to phone numbers. You can also store a group of numbers (up to 20 digits) that you need to enter once your call connects. This is referred to as Chain Dialing. An example of this is a bank account number. Store the account number in one of the phonebook locations (refer to "Phonebook (Storing Phone Numbers, Names, Distinctive Rings and Speed Dial)" on page 35). When you call your bank and are prompted to enter the account number, scroll through your phonebook locations until you find your account number, and then press the **DIAL** soft key.

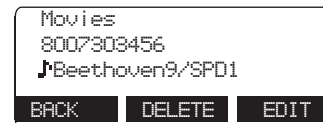
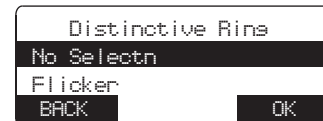

- If you choose not to store a Distinctive Ring, simply select the "No selection" option.
- If you choose not to store the name/number as a speed dial simply choose the "No selection" option.

### Steps for Entering Names and Special Characters

Refer to the letters on the number keys to select the desired characters. With each press of a number key (**0-9**), the displayed character appears in the following order: Upper case letters first, lower case letters next and finally the number corresponding to the key.

	Number of times key is pressed								
keys	1	2	3	4	5	6	7	8	9
1	1								
2 abc	A	B	C	a	b	c	2		
3 def	D	E	F	d	e	f	3		
4 ghi	G	H	I	g	h	i	4		
5 jkl	J	K	L	j	k	l	5		
6 mno	M	N	O	m	n	o	6		
7 pqrs	P	Q	R	S	p	q	r	s	7
8 tuv	T	U	V	t	u	v	8		
9 wxyz	W	X	Y	Z	w	x	y	z	9
0 oper	&	(	)	<	>	/	(blank)	-	_
	.	,	:	?	!	@	'	"	*
	#	0							

#### If you make a mistake while entering a name

Use \*/ **tone**/**<** or **#**/**>** to move the cursor to the incorrect character. Press the **DELETE** soft key to erase the wrong character, and then enter the correct character. To delete all characters press and hold the **DELETE** soft key.

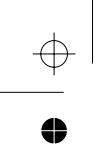

For example, to enter **Movies**:

- 1) When the phone is in standby mode, press **phonebook** and the **STORE** soft key. **Store/Edit Name** appears.
- 2) Press **6** once, and then press **#>** to move the cursor to the right.
- 3) Press **6** six times.
- 4) Press **8** six times.
- 5) Press **4** six times.
- 6) Press **3** five times.
- 7) Press **7** eight times.
- 8) When finished, press the **OK** soft key.

To continue to store the telephone number, proceed to step 5 in “Phonebook (Storing Phone Numbers, Names, Distinctive Rings, and Speed dial)” on page 35.

[38]



- If the next character uses the same number key, you must press **#>** to move the cursor over. Otherwise the next time you press the number key, it changes the character that was previously set.



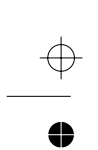

- During a call, don't press **end** on the handset or the call will be disconnected.

## Viewing the Phonebook

Your phone stores names/numbers in the phonebook memory locations, and you can search names in alphabetical order. You can view the phonebook even while the phone is in use.

- 1) Press **phonebook**. If you recall the phonebook during a call, the **COPY** and **STORE** soft key will not appear.
- 2) Press  $\Delta$  /vol/^ or  $\Delta$  /vol/∨ or the number keypad to scroll through the phonebook locations. Phonebook locations appear in alphabetical order (from first to last when you press  $\Delta$  /vol/∨ from last to first when you press  $\Delta$  /vol/^).



You can also use the letters on the number keys to select the first letter of the desired name. Press a number key (**2-9** and **0**) once for the first letter, twice for the second letter, and so on. The first location that begins with the letter you entered appears.

For example, to search for an entry beginning with the letter M, press 6 once. Press  $\Delta$  /vol/^ or  $\Delta$  /vol/∨, until the phonebook location is displayed.

- 3) To finish the viewing operation:  
From the Handset-press **end** (or the **BACK** soft key or **talk/flash** during a call).

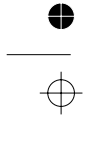



## Making Calls Using the Phonebook

### From Standby Mode

- 1) When the phone is in standby mode, view the phonebook location to dial (see "Viewing the Phonebook" on page 39).
- 2) Press **talk/flash** or **speaker** on the handset. The displayed number is dialed.
- 3) To hang up, press **end**.

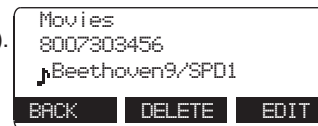

### From Talk Mode

- 1) Press **talk/flash** or **speaker**.
- 2) View the phonebook location to dial (see "Viewing the Phonebook" on page 39).
- 3) Press the **DIAL** soft key. The number displayed in the phonebook location is dialed.
- 4) To hang up, press **end**.

## Speed Dialing

You can program up to ten speed dial numbers in each handset and the base. You must program a speed dial number before you can use the speed dialing feature. When the phone is in standby mode, press and hold a number key (0-9) associated with the speed dial location desired until the phone number appears; then press **talk/flash** or **speaker**. The number stored in that speed dial location (SPD1 - SPD0) is then dialed.



- For New Zealand: Telecom access numbers are pre-programmed into speed dial locations as follows.
- Divert On : SPD1
- Divert Off : SPD2
- Block CID: SPD3
- Messages: SPD4
- Directory: SPD6

PHONEBOOK

## Editing or Erasing a Stored Name, Phone Number, Distinctive Ring and Speed Dial

- 1) When the phone is in standby mode, press **phonebook**.
- 2) Use  $\Delta$ /**vol**/ $\wedge$  or  $\Delta$ /**vol**/ $\vee$  or the number keypad to select desired phonebook entry (see "Viewing the Phonebook" on page 39).



### a. Editing the stored data.

- 1) When the phonebook location to be edited appears, press the **EDIT** soft key. Store/Edit Name appears.
- 2) Follow the steps 3-7 under "Phone book (Storing phone numbers, names, distinctive rings and speed dial)" on page 35 to complete the editing operation.
- 3) Press the **OK** soft key. You will hear a confirmation tone.



### b. Deleting the stored data.

- 1) When the phonebook location to be deleted appears, press the **DELETE** soft key. Delete Memory? appears.
- 2) Press  $\Delta$ /**vol**/ $\wedge$  or  $\Delta$ /**vol**/ $\vee$  to move the pointer to yes.
- 3) Press the **OK** soft key. You will hear a confirmation tone and Deleted! appears.

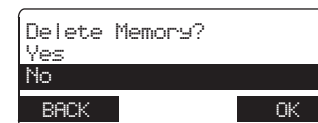



## Copying Phonebook Locations

Copy Phonebook allows you to transfer stored phonebook locations from handset to other handset without having to manually re-enter names and numbers. You can transfer one memory (phonebook location) at a time, or all memory locations at once.

- 1) When the phone is in standby mode, press **phonebook**.
- 2) Press the **COPY** key.
- 3) Press  $\Delta$  /vol/  $\wedge$  or  $\Delta$  /vol/  $\vee$  to select the handset to which you want to transfer the phonebook locations and then press the **OK** soft key.
- 4) Press  $\Delta$  /vol/  $\wedge$  or  $\Delta$  /vol/  $\vee$  to select One Memory or All Memory, and then press the **OK** soft key. If you select All Memory, Are you sure? appears on the display screen.  
Press  $\Delta$  /vol/  $\wedge$  or  $\Delta$  /vol/  $\vee$  to select Yes, and then press the **OK** soft key.  
If you select One Memory, press  $\Delta$  /vol/  $\wedge$  or  $\Delta$  /vo/  $\vee$ , or the number key (2-9 and 0) to select the phonebook location you want to export and then press the **COPY** soft key.
- 5) The phonebook locations will be transferred to the handset. Copying appears along with the name of the receiving handset. When the transfer is completed, Done! Appears.

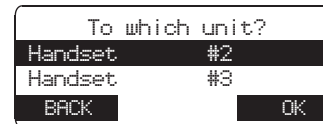

[42]



- This feature can only be used with multiple handsets.
- If the memory location on the receiving handset is full, and cannot store the phonebook locations, you will hear a beep.



note

- If you answer a call before the Caller ID message is received, the Caller ID message will not appear.
- When the call is received via a Telephone company that does not offer Caller ID service, the caller's phone number and name does not appear. (This includes some international Calls.)
- When the call is received via a private branch exchange (PBX), the caller's phone number and name may not appear.

### Caller ID and CIDCW (Caller ID on Call Waiting)

You must subscribe to Caller ID services through your local telephone provider to use these features. CIDCW (Caller ID on Call Waiting) is available in Australia only. When the telephone rings, the Caller ID feature allows you to view the caller's name, phone number, date and time of call. With CIDCW (Caller ID on Call Waiting), you will hear a call waiting tone while you are on a call, and the Caller ID data is displayed. To accept the waiting call, press **talk/flash** on the handset. Additionally, you can dial a number stored in the Caller ID list or save data to your phonebook locations.

**Important:**

Memory locations for Caller ID messages and phonebook locations (including Speed Dials) are common; you can store up to all 100 locations for each handset and the base. A Caller ID message is not stored when you have stored 100 of the phonebook locations. When you have stored all 100 of the phonebook locations and Caller ID messages in total, the earliest Caller ID message is overwritten.

The date and time received	—	10/12 11:20AM
Caller's name	—	Jane Smith
Caller's phone number	—	2145551234

When the Caller ID message is received, the display shows the caller's phone number along with the date and time. The incoming call information is stored in the Caller ID record. If the Caller ID service includes the caller's name, the name will appear in the display (up to 15 characters).

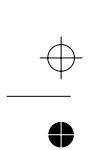

You may receive any one of the following messages:

When a private name is received; Private

When a private number is received; Private

When a unknown name is received; Unavailable

When a unknown number is received; Unavailable

When invalid data is received; Incomplete Data

When an overseas call(0000) is received (New Zealand only); overseas call

 Data errors appear as "■".

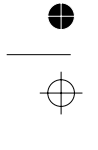



- The number of calls from the same Caller ID appears next to the received time. Once you view the new message, the number will disappear.

## Viewing the Caller ID List

The Caller ID list stores information for incoming calls - even unanswered calls. You can store up to 100 Caller ID messages and phonebook locations (including Speed Dials) for each handset and the base. You can view the Caller ID list through the handset and base during a call or when the phone is in standby mode.

- 1) Press **cid**.  
The summary screen appears. The screen shows the number of new messages and total messages.

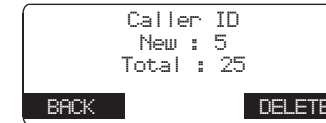

- 2) To view the Caller ID messages in historical order (newest to oldest or from oldest to newest), use, **▲/vol/▲** or **▲/vol/▼** to scroll through the messages from the latest to the earliest, or **▲/vol/▲** or **▲/vol/▼** to scroll back through the messages.

To view the Caller ID messages with alphabetical search, press the number key pad (**2-9** and **0**) with the letter associated with the first letter of the desired message.

**note** Once you view the Caller ID list with alphabetical search, you cannot switch back to historical order unless you exit and re-enter the operation.

- 3) To finish the viewing operation:  
Press **end** (or the **BACK** soft key or **talk/flash** during a call).

#### Deleting a Caller ID Message

- 1) When the phone is in standby mode, view the Caller ID information to be deleted (see "Viewing the Caller ID List" on page 45).
- 2) Press the **DELETE** soft key on. Delete Caller ID appears
- 3) Press  $\wedge$  /vol/ $\wedge$  or  $\wedge$  /vol/ $\vee$  to select Yes.
- 4) Press the **OK** soft key. You will hear a confirmation tone.

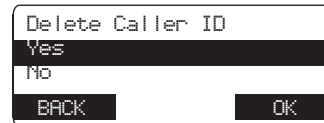

- During a call, don't press **end** or the call will disconnect.
- Once the Caller ID data has been deleted, the information cannot be retrieved



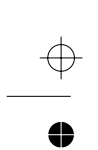

**note**

- Once the Caller ID data has been deleted, the information cannot be retrieved

**Deleting all Caller ID names/numbers**

- 1) When the phone is in standby mode, press **cid**.
- 2) Press the **DELETE** soft key.  
Delete All? Appears.
- 3) Press **▲ /vol/▲** or **▲ /vol/▼** to choose **Yes**.
- 4) Press the **OK** soft key. You will hear a confirmation tone.

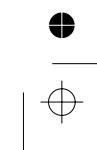
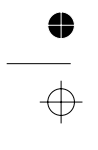
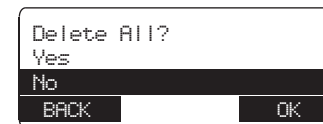
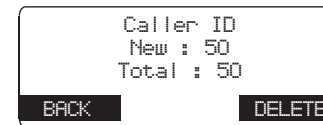



### Using the caller ID Message List Calling a Party from the Caller ID List

- 1) When the phone is in standby mode, select the Caller ID message (see "Viewing the Caller ID List" on page 45).
- 2) Press **talk/flash** or **speaker**. The displayed phone Number will be dialed automatically

#### Talk mode

- 1) When the phone is in talk mode, select the Caller ID message you want to dial (see "Viewing the Caller ID List" on page 45).
- 2) Press the **DIAL** soft key, and the number will be dialed.

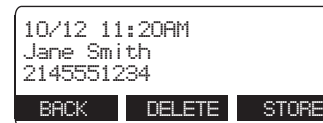

- If the CallerID message does not have the number, you cannot store the message in the Phonebook. If it was received as private/unknown name, the message will be stored as <No Name>.
- Even if the 100 memory locations are full, the message will be stored in the Phonebook. However, the message will be erased from the Caller ID list.

CALLER ID

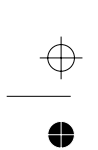

### Storing Caller ID messages in the Phonebook

Messages shown in the Caller ID list can be stored in the phonebook. The phone number and name of the party on the Caller ID list can be stored in memory.

- 1) When the phone is in standby mode, select the Caller ID message to be stored. Then press the **STORE** soft key. Store/Edit Name appears. If the Caller ID message is already stored in memory, you will hear a beep and This data is already stored!! appears. The number will not be stored.
- 2) To complete the setting, follow the steps 3-8 in "Phonebook (Storing Phone Numbers, Names, Distinctive Rings, and Speed dial)" on page 35

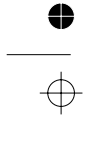

## Multi-Handset Features

The features in this section require a minimum of two handsets to operate. To add additional handsets to your system, see "Expanding Your Phone" on page 14.

### Using DirectLink Mode

To use this feature you must enter the handsets into Directlink Mode first. To enter Directlink Mode see page 17.

### DirectLink call

- 1) When the phone is in DirectLink standby mode, press **Directlink** soft key (example of DirectLink from handset #1).
- 2) Select the handset to which you wish to DirectLink with by pressing the number keys (**0-9**). Your handset will then page the other handset.
- 3) On the receiving handset, press **talk/flash**, the **ANSWER** soft key, or if Any Key Answer is on, press any number key, **\*/tone/ ←**, or **#/ →**.
- 4) When you finish your conversation, press **end** or the **END** soft key on either handset. Return the handset to the cradle, or press **CANCEL** soft key, and then **OK** soft key to return to normal standby mode (canceling DirectLinkmode).

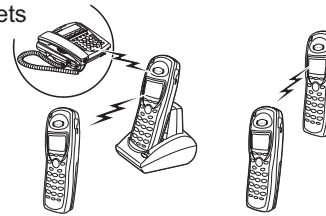

- Handsets can be in Direct Link mode while other handsets are in use.



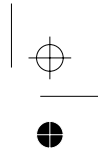
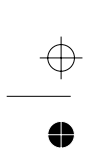

### 3-Way Conferencing

The phone permits 3-way conversations between 2 handsets and an outside line.

- 1) Initiate the call normally. Once the call is in progress, other people can join the call.
- 2) To join a conference call, press **talk/flash** or **speaker** to use the handset speaker phone.
- 3) To leave a conference call, simply hang up as you normally would. All other parties will remain connected.
- 4) To end a conference call completely, all local parties must hang up. The conference call will also end when the calling party hang up.

### Intercom/Call Transfer Feature

The intercom feature lets you communicate with another handset without using the phone line.

#### Intercom

- 1) With the phone in standby mode, press **intcom/hold**.
- 2) Select the handset you want to talk with within 30 seconds. To select the handset press, **▲/vol/▲** or **▲/vol/▼** and then press the **OK** soft key. If you select **ALL**, all other handsets will be paged. An intercom tone sounds. To cancel intercom, Press the **CANCEL** soft key on the initiating handset.

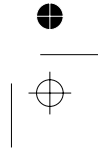
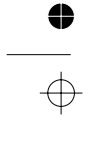
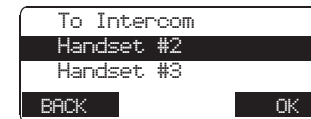

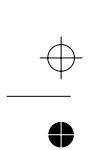

- 3) To answer a page, press **talk/flash**, or **intcom/hold** or the **ANSWER** soft key.  
If Any Key Answer is enabled, pressing a number key, \* /tone/ ←, or # /→ will answer the page. If AutoTalk is enabled, you can answer the page simply by picking up the handset.

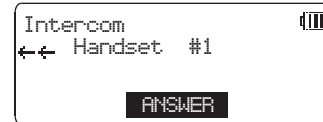

- 4) To hang up the intercom call, press **end** or the **END** soft key on either handset.

### Call Transfer Feature

- 1) During a call, press **intcom/hold** on the handset.
- 2) Select the handset you want to talk with within 10 seconds. To select the handset press, **△ /vol/ ^ or ▽ /vol/ v** and then press the **OK** soft key.

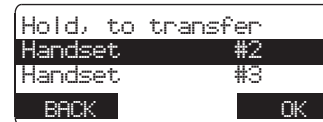

If you select **All**, all other handsets and the base will be paged. An intercom tone sounds. To cancel intercom, Press the **CANCEL** soft key on the initiating handset.

- 3) To answer a page, press **talk/flash**, or **intcom/hold** or the **ANSWER** soft key.  
If Any Key Answer is enabled, pressing a number key, \* /tone/ ←, or # /→ will answer the page. If AutoTalk is enabled, you can answer the page simply by picking up the handset.
- 4) To speak to the caller, press **talk/flash** on the receiving handset.



- If you receive an outside/intercom call or page while selecting the other handset (or the base), the operation will be canceled.
- If the party does not answer within one minute, the operation is canceled.

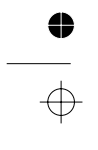



### note

- If the battery pack is completely drained, the handset will not beep when paging.

## Changing the Digital Security Code

The digital security code is an identification code used to connect the handset and the base unit. Normally, setting the code is not necessary. In the rare situation that you suspect another cordless telephone is using the same security code, you can change the code. To change the digital security code:

- 1) De-register all the handsets you have (see "De-register the handset" on page 26).
- 2) Register the handsets by following step 2-3 in "Registering the handset" on page 15.

## Find Handset

To locate the handset, press **find handset** on the base when the phone is in standby mode. All registered handsets beep for 60 seconds, and **PAGING** appears on the handset display. To cancel paging, press any key on the handset or **find handset** on the base.

## Installing the Beltclip

### To attach the beltclip

Insert the beltclip into the holes on each side of the handset. Press down until it clicks.



### To remove the beltclip

Pull either side of the beltclip to release the tabs from the holes.

## Headset Installation

Your phone can be used with an optional headset. To use this feature, insert the headset plug into the headset pack. Your phone is ready for hands-free conversations. (Headset can be purchased from a retailer or by visiting the web site. See page 56.)

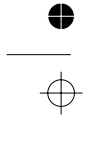

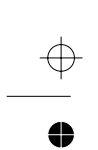

## Note on Power Sources

### Power Failure

During the period that the power is off, you will not be able to make or receive calls with the telephone.

### Battery replacement and handling

When the operating time becomes short even after a battery is recharged, please replace the battery. With normal usage, your battery should last about one year. Please contact your place of purchase or the Uniden Parts Department for a replacement battery.

### Warning

To avoid the risk of personal injury or property damage from fire or electrical shock, only use the Uniden battery model and Uniden adapter model specifically designated for this product.

#### Caution

- Use only the specified Uniden battery pack (BT- 446).
- Do not remove the batteries from the handset to charge them.
- Never throw the battery into a fire, disassemble them, or heat them.
- Do not remove or damage the battery casing.

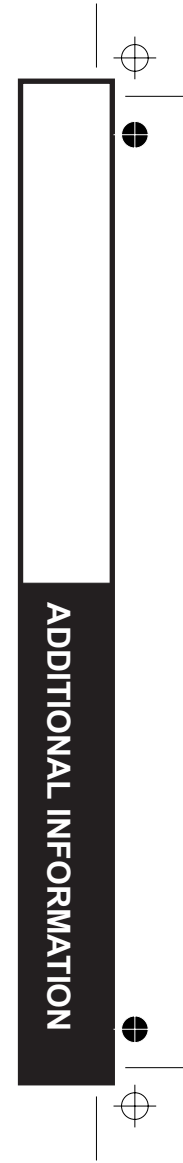
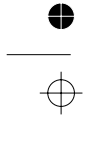

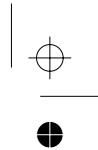
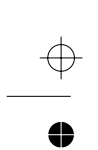

## Low Battery Alert

When the battery pack is very low, the phone is programmed to eliminate functions in order to save power.

### The battery pack needs to be charged when:

- The empty battery icon appears.
- Low Battery appears in the display.

If the phone is in standby mode, none of keys will operate. If you are on a call, complete your conversation as quickly as possible, and return the handset to the cradle.

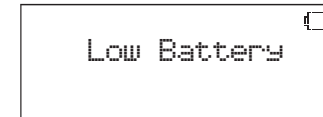

### Cleaning the battery charging contacts

To maintain a good charge, clean the charging contacts on the handset once a month. Dampen a cloth with plain water. Gently rub the damp cloth over the charging contacts until all visible dirt is removed. Dry the contacts thoroughly before returning the handset to the base.

**Caution:** Do not use paint thinner, benzene, alcohol, or other chemical products. Doing so may discolour the surface of the telephone and damage the finish.

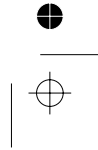
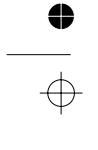
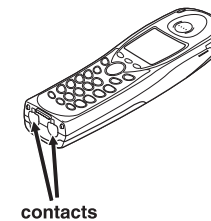



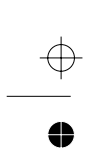

## General Information

Operating temperature:  
0 °C to +50 °C (+ 32 °F to +122 °F)

### AC Adapter Information

AC Adapter part number: AAD-041S for the base	AAD-210 for the charger
Input Voltage: 230-240VAC 50Hz	230-240 VAC 50Hz
Output Voltage: 9V DC 350mA	9V DC 210mA

### Battery Information

Battery part number: BT- 446  
Capacity: 800mAh, 3.6V

- To avoid damage to the phone use only Uniden AAD-041S and BT- 446, and AAD-210 with your phone.
- If the handset is left off of the base, the actual Talk mode duration will be reduced respective to the amount of time the handset is off the base.

Recharge your phone on a regular basis by returning the handset to the base after each phone call. When the operating time becomes short even after the battery is recharged, please replace the battery. With normal usage, the battery should last about one year.

Please contact your retailer for replacement adapters or batteries or visit our website at [www.uniden.com.au](http://www.uniden.com.au) or [www.uniden.co.nz](http://www.uniden.co.nz).

Specifications, features, and availability of optional accessories are all subject to change without prior notice.

[56]

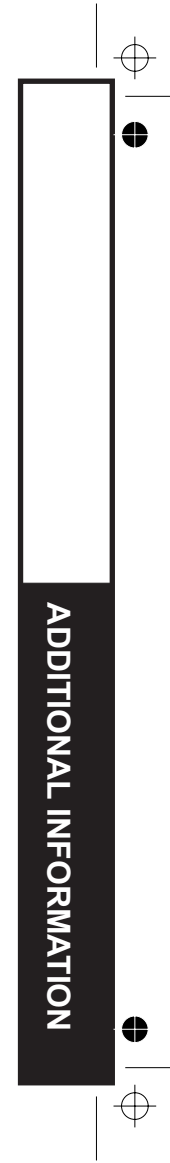
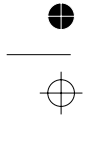

## Troubleshooting

If your phone is not performing to your expectations, please try these simple steps first. If these steps do not solve your problem, visit our website for further information ([www.uniden.com.au](http://www.uniden.com.au) or [www.uniden.co.nz](http://www.uniden.co.nz)).

Symptom	Suggestion
The charge LED won't illuminate when the handset is placed in the cradle.	<ul style="list-style-type: none"><li>• Make sure the AC adapter is plugged into the charger and wall outlet.</li><li>• Make sure the handset is properly seated in the cradle.</li><li>• Make sure the charging contacts on the handset are clean.</li></ul>
The audio sounds weak.	<ul style="list-style-type: none"><li>• Move the handset and/ or base away from metal objects or appliances and try again.</li><li>• Make sure that you are not too far from the base.</li></ul>
Can't make or receive calls.	<ul style="list-style-type: none"><li>• Make sure that you are not too far from the base.</li><li>• Make sure the line is not in use. If call is already using a line, you cannot use that line to make another outside call.</li><li>• Check both ends of the base telephone line cord.</li><li>• Make sure the AC adapter is plugged into the base and wall outlet.</li><li>• Disconnect the AC adapter for a few minutes, and then reconnect it.</li><li>• De- register the handset (see "De- register the Handset" on page 26) and register the handset (see "Register the Handset" on page 15).</li></ul>
The handset doesn't ring or receive a page.	<ul style="list-style-type: none"><li>• Make sure that you are not too far from the base.</li><li>• Charge the batteries in the handset for 15- 20 hours by placing the handset on charging cradle.</li><li>• De- register the handset (see "De- register the Handset" on page 26) and register the handset (see "Register the Handset" on page 15).</li></ul>
During power failure, can't make or receive a call.	<ul style="list-style-type: none"><li>• Make sure to use corded base handset to make or receive a call.</li><li>• Make sure that TEL line cord is connected firmly.</li></ul>

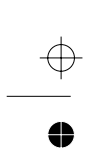

Symptom	Suggestion
Severe noise interference.	<ul style="list-style-type: none"><li>• Keep the handset away from microwave ovens, computers, remote control toys, wireless microphones, alarm systems, intercoms, room monitors, fluorescent lights, and electrical appliances.</li><li>• Move to another location or turn off the source of interference.</li></ul>
The Caller ID does not display.	<ul style="list-style-type: none"><li>• The handset was picked up before the second ring.</li><li>• The call was placed through a switchboard.</li><li>• Call your local telephone company to verify your Caller ID service is current. There may be a problem with your Caller ID service.</li></ul>
You cannot register the handset at the base.	<ul style="list-style-type: none"><li>• Charge the battery pack for 15- 20 hours.</li><li>• De- register the handset (see "De- register the Handset" on page 26) and register the handset (see "Register the Handset" on page 15).</li><li>• Make sure that you have registered all handsets.</li></ul>
The handset doesn't communicate with other Handsets.	<ul style="list-style-type: none"><li>• De- register the handset (see "De- register the Handset" on page 26) and register the handset (see "Register the Handset" on page 15).</li><li>• Make sure there are not two handsets already using the conference feature.</li><li>• Make sure that another handset or base is not in privacy mode.</li></ul>
An extra handset can't join the conversation.	<ul style="list-style-type: none"><li>• Make sure that another handset is not in privacy mode.</li></ul>

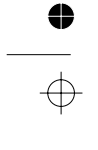

## Liquid Damage

Moisture and liquid can damage your cordless phone. In case of accidental submersion, please read the following steps.

Case	Action
If the handset or base is exposed to moisture or liquid, but it only affects the exterior plastic housing.	Wipe off the liquid, and use as normal.
If moisture or liquid has entered the plastic- housing (i. e. liquid can be heard in the phone or liquid has entered the handset battery compartment or vent openings on the base).	<p><b>Handset:</b></p> <ol style="list-style-type: none"><li>1) Remove the battery cover and leave it off for ventilation.</li><li>2) Remove the battery pack by disconnecting.</li><li>3) Leave the battery cover off and the battery pack disconnected for at least 3 days.</li><li>4) Once the handset is completely dry, reconnect the battery pack and he battery cover.</li><li>5) Recharge the handset's battery pack for 20 hours before using again.</li></ol> <p><b>Base:</b></p> <ol style="list-style-type: none"><li>1) Disconnect the AC adapter from the base unit, cutting off electrical power.</li><li>2) Disconnect the telephone cord from the base unit.</li><li>3) Let dry for at least 3 days.</li></ol> <p><b>IMPORTANT:</b> You must unplug the telephone line while recharging the battery pack to avoid charge interruption.</p> <p><b>CAUTION:</b> DO NOT use a microwave oven to speed up the drying process. This will cause permanent damage to the handset, base and the microwave oven. After following these steps, if your cordless telephone does not work, please visit our website for further information (<a href="http://www.uniden.com.au">www.uniden.com.au</a> or <a href="http://www.uniden.co.nz">www.uniden.co.nz</a>).</p>

## Memory List

	Name	Phone No.		Name	Phone No.		Name	Phone No.
1			35			69		
2			36			70		
3			37			71		
4			38			72		
5			39			73		
6			40			74		
7			41			75		
8			42			76		
9			43			77		
10			44			78		
11			45			79		
12			46			80		
13			47			81		
14			48			82		
15			49			83		
16			50			84		
17			51			85		
18			52			86		
19			53			87		
20			54			88		
21			55			89		
22			56			90		
23			57			91		
24			58			92		
25			59			93		
26			60			94		
27			61			95		
28			62			96		
29			63			97		
30			64			98		
31			65			99		
32			66			100		
33			67					
34			68					

[60]

MEMORY LIST

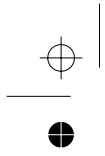

**Memo**

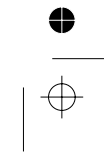
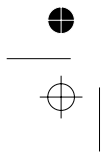
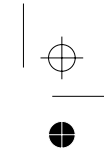

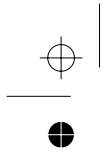

**Memo**

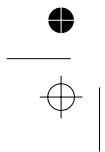

[62]



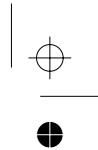
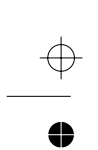

## Index

### 0- 9

20 ring options	19
3- Way Conferencing	51

### A

Animation screen	7
Anykey Answer	20
AutoTalk	20

### B

Banner	21
Battery	
Replacement and handling	54
Beltclip	53

### C

Call transfer feature	52
Caller ID	
Call Waiting	29
Caller ID services	43
Calling	48
CIDCW	43
Deleting	47
Setting	23
Storing	49
Viewing	45
Chain dialing	36
Clock	23
Contrast	21
Copying phonebook	42

### D

De- register the handset	26
Dial mode	24
Digital security code	53
DirectLink	17
Distinctive ringer	20

### E, F, G, H

Earpiece volume	31
Expanding your phone	14
General information	56
Global Setup	23
Hands- free conversation	28
Headset installation	53
Hold	29

### I, J, K, L

Intercom	51
Key touch tone	22
Liquid damage	59

### M, N, O

Making a call	27
Mute	32

### P, Q

Page	53
Phonebook	
Editing	41
Erasing	41
Making calls	40
Storing	35
Viewing	39

Privacy Mode	33
--------------	----

### R

Receiving a call	27
Redialing a call	30
Register the handset	15
Ringer Adjusting	31
Room / baby monitor	18

### S

Setting up	9
Base unit	10
Extra handset	14
Handset	11, 19
Menu options	17
Soft Key	8
Speed dialing	40

### T, U, V, W, X, Y, Z

Transferring a call	52
Troubleshooting	57
Voice Mail Tone	34
Warranty	66

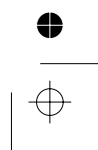
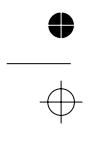



## Main Menu Flow Chart

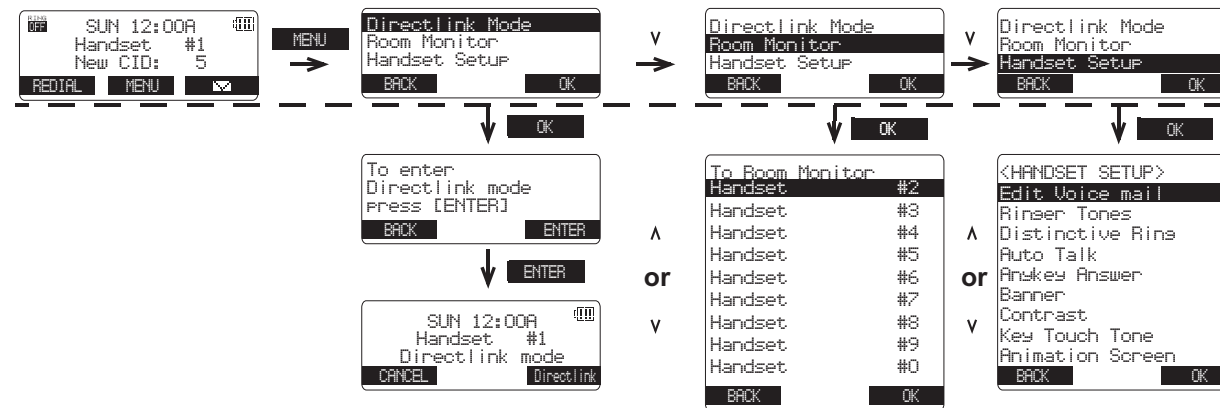

## Main Menu Flow Chart

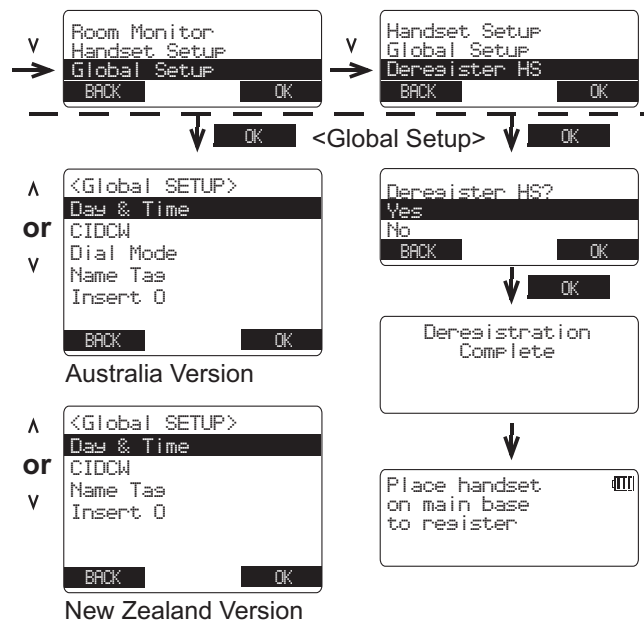

## One Year Limited Warranty

**Important:** Evidence of original purchase is required for warranty service.

**Warrantor:** Uniden Australia Pty Limited A.B.N. 58 001 865 498 Uniden New Zealand Limited  
**Warranty is only valid in the original country of purchase.**

**ELEMENT OF WARRANTY:** Uniden warrants to the original retail owner for the duration of this warranty, its DSS7815/DSS7815+1 (herein after referred to as the Product), to be free from defects in materials and craftsmanship with only the limitations or exclusions set out below.

**WARRANTY DURATION:** This warranty to the original retail owner only, shall terminate and be of no further effect 12 months after the date of original retail sale. This warranty will be deemed invalid if the product is;

- (A) Damaged or not maintained as reasonable and necessary,
- (B) Modified, altered or used as part of any conversion kits, subassemblies, or any configurations not sold by Uniden,
- (C) Improperly installed,
- (D) Repaired by someone other than an authorized Uniden Repair Agent for a defect or malfunction covered by this warranty,
- (E) Used in conjunction with any equipment or parts or as part of a system not manufactured by Uniden.

**PARTS COVERED:** This warranty covers for one (1) year, the Base unit and handset ((DSS7815) or base, charger and handsets (DSS7815+1). All accessories (AC Adapter etc) are covered for 90 days only.

**STATEMENT OF REMEDY:** In the event that the product does not conform to this warranty at any time while this warranty is in effect, the warrantor at its discretion, will repair the defect or replace the product and return it to you without charge for parts or service. THIS WARRANTY DOES NOT COVER OR PROVIDE FOR THE REIMBURSEMENT OR PAYMENT OF INCIDENTAL OR CONSEQUENTIAL DAMAGES. THIS GUARANTEE IS IN ADDITION TO AND DOES NOT IN ANY WAY AFFECT YOUR RIGHTS UNDER THE CONSUMER GUARANTEE ACT.

**PROCEDURE FOR OBTAINING PERFORMANCE OR WARRANTY:** In the event that the product does not conform to this warranty, the Product should be shipped or delivered, freight pre-paid, with evidence of original purchase (eg. a copy of the sales docket), to the warrantor at:

### UNIDEN AUSTRALIA PTY LIMITED SERVICE DIVISION

345 Princes Highway,  
Rockdale,  
NSW 2216,  
AUSTRALIA  
Fax: (02) 9599 3278  
www.uniden.com.au

### UNIDEN NEW ZEALAND LIMITED SERVICE DIVISION

150 Harris Road,  
East Tamaki,  
Auckland,  
NEW ZEALAND  
Fax: (09) 274 4253  
www.uniden.co.nz

[66]

WARRANTY

**THANK YOU FOR BUYING A UNIDEN PRODUCT.**

**Uniden®**

(c) 2005 Uniden Australia Pty Limited. Uniden New Zealand Ltd. Printed in China UPZZ01748BA(0)

## Free Manuals Download Website

<http://myh66.com>

<http://usermanuals.us>

<http://www.somanuals.com>

<http://www.4manuals.cc>

<http://www.manual-lib.com>

<http://www.404manual.com>

<http://www.luxmanual.com>

<http://aubethermostatmanual.com>

Golf course search by state

<http://golfingnear.com>

Email search by domain

<http://emailbydomain.com>

Auto manuals search

<http://auto.somanuals.com>

TV manuals search

<http://tv.somanuals.com>