

**Uniden** | A World Without Wires®

UNIDEN  
CORDLESS  
PHONES



# DXI4560 & DXI4561 Series

**OWNER'S MANUAL**

# Contents

<b>Welcome/Accessibility</b> .....	<b>2</b>	Adjusting the Earpiece Volume .....	26
<b>Terminology/Manual Conventions</b> .....	<b>3</b>	Using Call Waiting.....	27
<b>Product Overview</b> .....	<b>4</b>	Selecting a Different Channel .....	27
<b>Controls and Functions</b> .....	<b>5</b>	Find Handset .....	27
<b>Installing the Phone</b> .....	<b>7</b>	Tone Dialing Switch-over.....	28
Choosing the Best Location .....	7	Voice Mail Waiting Indicator .....	28
Installing the Rechargeable Battery Packs into the Handsets.....	8	<b>Caller ID and CIDCW (Caller ID on Call Waiting) .....</b>	<b>29</b>
Installing the Base Unit and Charging Cradle .....	9	Caller ID on Call Waiting (CIDCW) .....	30
Mounting the Base Unit on a Wall.....	11	Viewing the Caller ID Message List .....	30
<b>Register Handsets to the Main Base before Using!</b> .....	<b>13</b>	Deleting Information from the Caller ID List.....	31
When to Re-register Handsets .....	14	<b>Changing the Digital Security Code .....</b>	<b>32</b>
<b>Basic Setup</b> .....	<b>15</b>	<b>Maintenance</b> .....	<b>33</b>
Activating AutoTalk.....	15	<b>Troubleshooting</b> .....	<b>36</b>
Activating Caller ID on Call Waiting (HS1 only) .....	16	Liquid Damage.....	39
Programming Your Area Code .....	16	<b>Precautions</b> .....	<b>40</b>
Choosing the Dialing Mode (HS1 only).....	17	The FCC Wants You To Know .....	41
Setting the Language.....	18	I.C. Notice .....	43
<b>Using the Speed Dial Memory</b> .....	<b>19</b>	<b>One Year Limited Warranty</b> .....	<b>44</b>
Storing a Name and Number in Memory .....	19	<b>Index</b> .....	<b>45</b>
Storing Caller ID in Speed Dial Memory .....	22		
<b>Using Your Phone</b> .....	<b>23</b>		
Making and Receiving Calls .....	23		
Making a Call from Speed Dial Memory .....	23		
Making a Call from the Caller ID List .....	24		
Transferring a Call .....	25		
Redialing the Last Dialed Number.....	26		
Selecting the Ring Tone and Volume .....	26		

## Welcome

Congratulations on your purchase of the Uniden dual-handset cordless telephone. This cordless phone is designed for reliability, long life, and outstanding performance.

**Note: Illustrations in this manual are used for explanation purposes. Some illustrations in this manual may differ from the actual unit. The color of your cordless telephone may vary.**

Uniden® is a registered trademark of Uniden America Corporation.

AutoTalk, AutoStandby and UltraClear Plus are trademarks of Uniden America Corporation.

## Accessibility

Uniden provides a customer service hotline for accessibility questions. If you have a disability and need customer service assistance or if you have any questions about how Uniden's products can accommodate persons with disabilities, please call the accessibility voice/TTY line:

1-800-874-9314.

Our customer care hours as well as accessibility information can be found on our website, [www.uniden.com](http://www.uniden.com), under the "Accessibility" link. If your call is received outside of our business hours, you can leave us a message and we will call you back.

## Terminology

<b>Base</b>	The main part of the phone that connects to your phone line and lets you make and receive calls.
<b>Charger</b>	A cradle that charges the handset battery. It connects to power but does not connect to a phone line.
<b>CID</b>	Caller ID is available from your telephone provider. With this service, you can see the name and number of incoming callers.
<b>CIDCW</b>	Caller ID on Call Waiting is available from your telephone provider. With this service, you can see incoming caller information while on another call.
<b>Handset</b>	A cordless handset that can be placed anywhere in your home or office where AC power is available.
<b>Standby</b>	The handset may be sitting on the cradle or out of the cradle, but is NOT in use. <b>[talk/flash]</b> has not been pressed and there is no dial tone.
<b>Talk</b>	When a dial tone has been enabled allowing the user to dial and carry on a conversation with an outside party.

## Manual Conventions

This manual uses several different type styles to help you distinguish between different parts of the phone:

- **lower case bold** text with "[ ]" indicates a key or button on the phone
- ALL CAPITALS indicates text on the display, such as menu options, prompts, and confirmation messages
- **lower case bold** text indicates a status light on the phone base

# Product Overview

## Main Phone Features

- 2.4 GHz Extended Range Technology
- Dual-Handset System  
(Extra Handset & Charger Included)
- Call Transfer from Handset to Handset
- Caller ID/Caller ID on Call Waiting
- 3-Line Backlit LCD
- Trilingual Menu Displays (English, Spanish, or French)
- 30 Caller ID Memory
- 10 Number Memory Dialing
- Last Number Redial
- Tone/Pulse Dialing
- Page/Find Handset Key
- Earpiece/Ringer Volume Controls
- Mute or Turn Ringer Off
- Hearing Aid Compatible
- 20-Channel Auto Scan
- Desk or Wall Mountable

# Controls and Functions Handsets

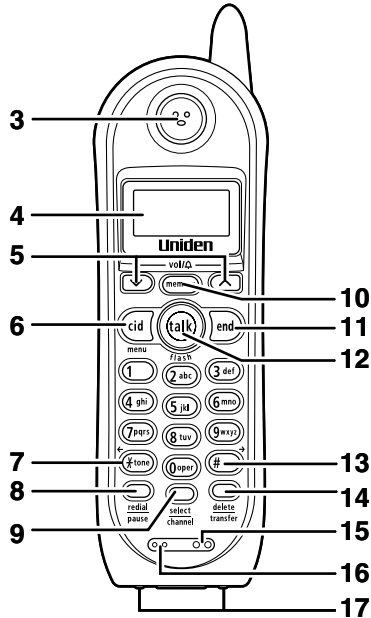
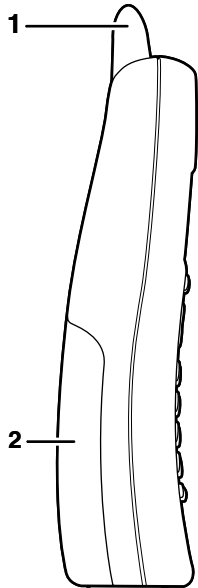

1. Handset antenna
2. Handset battery compartment
3. Handset earpiece
4. LCD display
5. **[vol/Δ/∧/∨]**  
(volume & ringer up/down) key
6. **[cid/menu]** key
7. **[\*/tone/←]** (left cursor) key
8. **[redial/pause]** key
9. **[select/channel]** key
10. **[memory]** key
11. **[end]** key
12. **[talk/flash]** key
13. **[#/→]** (right cursor) key
14. **[delete/transfer]** key
15. Handset ringer speaker
16. Handset microphone
17. Handset charging contacts

## Main Base Unit

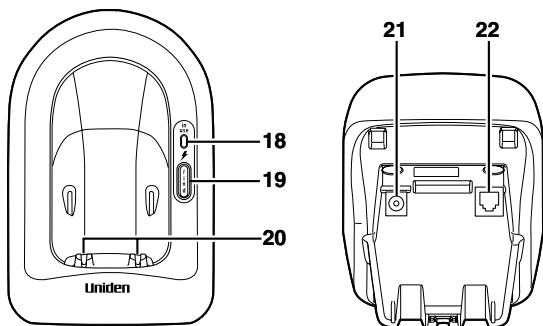

- 18. **in use/⚡** (in use/charge) LED / Voice mail waiting indicator (flashing)
- 19. **[find]** key
- 20. Base charging contacts
- 21. Base **DC IN 9V** jack
- 22. **TEL LINE** jack

## Extra Charging Cradle

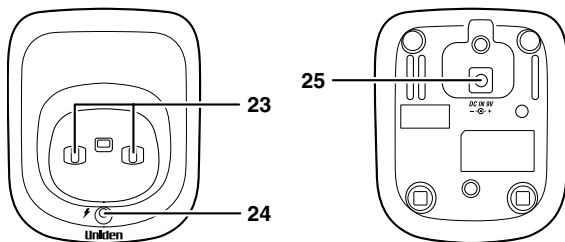

- 23. Charging contacts
- 24. **⚡** (charge) LED
- 25. Charging cradle **DC IN 9V** jack

# Installing the Phone

## Choosing the Best Location

Before choosing a location for your new phone, here are some important guidelines you should consider:

Avoid heat sources, such as radiators, air ducts, and sunlight

Avoid noise sources such as a window by a street with heavy traffic

Avoid television sets and other electronic equipment

Avoid microwave ovens

Avoid excessive moisture, extremely low temperatures, dust, mechanical vibration, or shock

Choose a central location

Avoid personal computers

Avoid other cordless telephones

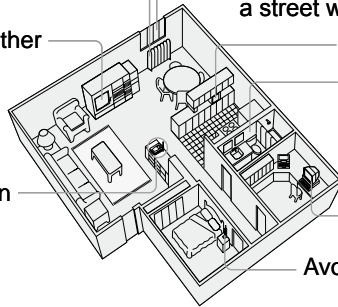

- The location should be close to both a phone jack and a continuous power outlet (one which is not connected to a switch).
- The base and each handset should be kept away from sources of electrical noise such as motors, microwave ovens, and fluorescent lighting.
- The cradle can be placed on a desk, tabletop, or mounted on a standard wall plate. For better reception, place the base as high as possible.
- The base should be placed in an open area for optimum range and reception.
- If your home has specially wired alarm equipment connected to the telephone line, be sure that installing the system does not disable your alarm equipment. If you have questions about what will disable your alarm equipment, contact your telephone company or a qualified installer.



## Installing the Rechargeable Battery Packs into the Handsets

Each handset is powered by a rechargeable battery pack. Once installed, the battery charges automatically when the handset is placed in the base or charging cradle.

To install the rechargeable battery pack:

- 1) Press down on the handset battery case cover (use the finger indentation for a better grip) and slide the cover downward to remove.
- 2) Plug the battery pack connector (red & black wires) into the small jack inside the battery compartment. (The connector notches fit into the grooves of the jack only one-way.) Match the wire colors to the polarity label in the battery compartment, connect the battery, and listen for a click to insure connection.
- 3) Make sure you have a good connection by slightly pulling on the battery wires. If the connection is secure, the battery jack will remain in place.
- 4) Place the battery case cover back in the handset by sliding it upwards until it clicks into place.

**Note: Use only the Uniden (BT-1006) rechargeable battery pack supplied with your phone.**

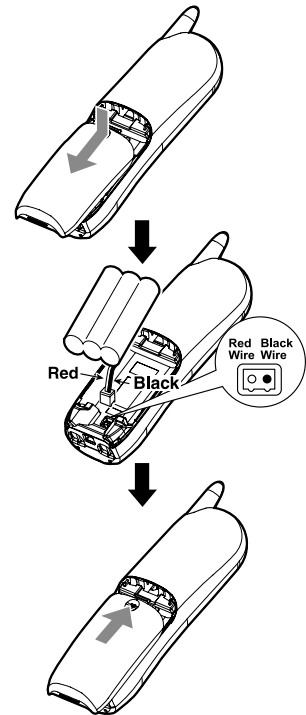

## Installing the Base Unit and Charging Cradle

- 1) Connect each AC adapter to the **DC IN 9V** jack and to each standard 120V AC wall outlet.

### Note:

- Use only the supplied **AD-0001 AC adapter** for the base unit and **AD-310** or **AD-1010** for the charging cradle. Do not use any other AC adapter.
  - Do not place the power cord where it creates a trip hazard or where it could become chafed and create a fire or electrical hazard.
- 2) Charge the handsets by placing one handset in the base unit and the other in the charging cradle with the keypad facing forward.

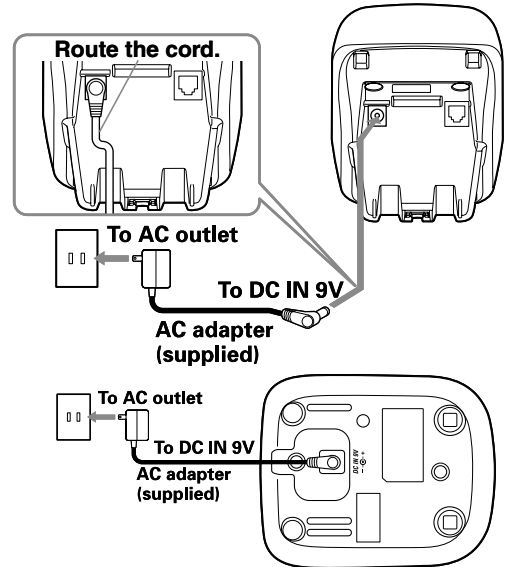

- 3) Make sure that the **in use** LED and LED illuminate. If the LED does not illuminate, check to see that the AC adapter is plugged in and that the handset makes good contact with the cradle's charging contacts.

**Note:**

- **Connect the AC adapter to a continuous power supply (not controlled by a wall switch).**
- **Place each cradle close to the AC outlet to avoid long extension cords.**
- **Charge your handsets at least 15 - 20 hours before plugging into the phone line.**

- 4) Once the handset battery packs are fully charged, connect the telephone line cord to the **TEL LINE** jack and a telephone outlet. If your telephone outlet isn't modular, contact your telephone company for assistance.

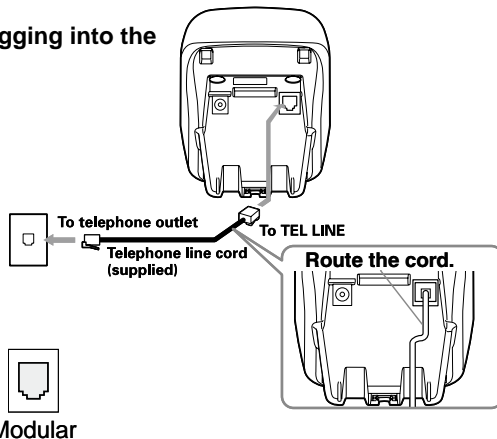
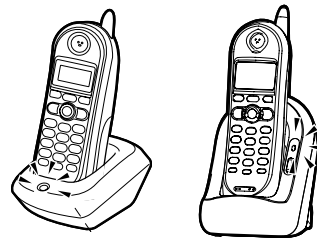

## Mounting the Base Unit on a Wall

### Standard wall plate mounting

This phone can be mounted on any standard wall plate.

- 1) Plug the AC adapter to the **DC IN 9V** jack.
- 2) Plug the AC adapter into a standard 120V AC wall outlet.
- 3) Plug the telephone line cord into the **TEL LINE** jack.
- 4) Route the telephone line cord through the groove as shown.
- 5) Plug the telephone line cord into the telephone outlet.
- 6) Align the mounting slots on the base with the mounting posts on the wall. Then push in and down until the phone is firmly seated.

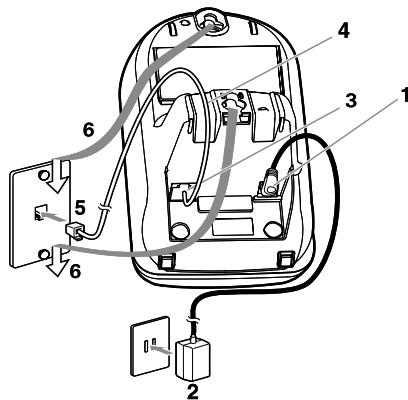

## Direct wall mounting

If you don't have a standard wall plate, you can mount your phone directly to the wall. Before doing this, consider the following:

- Avoid electrical cables, pipes, or other items behind the mounting location that could cause a hazard when inserting screws into the wall.
  - Try to mount your phone within 5 feet of a working phone jack to avoid excessive cord lengths.
  - Make sure the wall material is capable of supporting the weight of the base and handset.
  - Use #10 screws (minimum length of 1-3/8 inches) with anchoring devices suitable for the wall material where the base unit will be placed.
- 1) Insert two mounting screws into the wall (with their appropriate anchoring device), 3-15/16 inches apart. Allow about 1/8 of an inch between the wall and screw heads for mounting the phone.
  - 2) Refer to steps 1 through 6 on page 11 to mount the telephone.

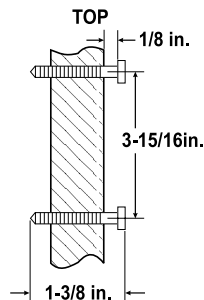

## Register Handsets to the Main Base before Using!

Both handsets will need to be registered to the main base unit before use. Whichever handset you choose to charge in the base unit will automatically register to the base unit. The handset charging in the extra charging cradle **MUST** also be registered to the base unit before use.

To register the extra handset:

- 1) Be sure both handsets are fully charged.
- 2) Pick up the handset from the charging cradle, and place it in the base unit. The **in use** LED light on the base unit will begin to flash, indicating that the registration is taking place.
- 3) Wait for at least 5 seconds, then pick up the handset from the base unit.
- 4) Press **[talk/flash]** on one handset. If TALK appears on the display, the handset is registered, press **[end]**. Then try with another handset. If each handset displays TALK, the handset has been registered to the base. Otherwise, return to step 1 and try again.
- 5) Once both handsets are registered, it doesn't matter which handset is placed in the base unit or the charging cradle.

### Note:

- **When you charge the handsets, Caller ID summary screen and the name of the handset appears. Following display is the example of handset No.1 (HS1).**
- **The charging cradle can be used to charge any handset.**

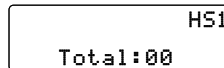

## When to Re-register Handsets

In some cases, it may be necessary to re-register your handsets. To re-register your handsets, please follow registration steps outlined on page 13.

Re-registration is required in the following scenarios:

- 1) You'll need to re-register both handsets (follow steps on page 13) each time the digital security code is changed. (Refer to page 32 for details regarding the Digital Security Code.)
- 2) When there is a power failure for more than one hour: If power failure occurs (e.g. due to electrical storm or if the unit is unplugged during a move), both handsets will need to be re-registered. To re-register, follow the same registration process on page 13.
- 3) If any handset's battery becomes very low, the handset must be recharged for 15 - 20 hours and re-registered to the main base unit.
- 4) In any circumstance in which you experience difficulty connecting to the main base to place or receive calls, the handset should be re-registered.

**Note: Make sure to return the handsets to the cradles after each phone call.**

## Basic Setup

There are five basic options that you will need to set up: AutoTalk, CIDCW (Caller ID on Call Waiting), Area Code, Dial Mode and Language.

CIDCW and Dial Mode options can only be set by using Handset 1.

If you try to set by using other handset, you will not see these options listed on the LCD screen. (You can easily identify Handset 1 shows as **HS1** will be seen in the display while the phone is charging.)

AutoTalk, Area Code and Language options can be set by using any handset.

```
▶Auto Talk :Off
Area Code :
Language :Eng
```

## Activating AutoTalk

AutoTalk will allow you to answer the phone simply by removing the handset from the cradle. You do not have to press a key to answer the incoming call.

To activate:

- 1) When the phone is in standby, press and hold **[cid/menu]**. The following screen appears.
- 2) Press **[select/channel]** to turn AutoTalk on.
- 3) Press **[end]** or return the handset to the charging cradle to complete the setting. The handset returns to standby.

```
▶Auto Talk :Off
CIDCW :On
Area Code :
```



## Activating Caller ID on Call Waiting (HS1 only)

Caller ID allows you to see the name and number of the calling party before you answer the phone. Caller ID on Call Waiting (CIDCW) lets you see the name and number of a call that comes in when you are on the line. You must subscribe to Caller ID service through your local telephone provider to use this feature.

- 1) When the phone is in standby, press and hold **[cid/menu]**. The following screen appears.
- 2) Press **[vol/4/~/]** to move the pointer to select CIDCW.
- 3) Press **[select/channel]** to toggle and turn on Caller ID on Call Waiting.
- 4) Press **[end]** and return the handset to the base unit to complete the setting. The handset returns to standby.

**Note: To enable the setting change of CIDCW, you need to return the handset to the base unit when you complete the setting.**

```
▶Auto Talk :Off
CIDCW      :On
Area Code  :
```

```
Auto Talk :Off
▶CIDCW    :On
Area Code :
```

## Programming Your Area Code

In some areas the telephone company may allow you to place a local call by dialing only 7 digits (instead of 10). If this is the case in your area, you can program your local area code in your phone. Programming your area code will allow you to see the caller's 7-digit phone number which will allow you to easily return the local call without modifying the number before dialing. If you get a call from outside your area code, you'll see all 10 digits.

To program your area code:

- 1) When the phone is in standby, press and hold **[cid/menu]**. The following screen appears.

```
▶Auto Talk :Off
CIDCW      :On
Area Code  :
```

- 2) Press **[vol/AM]** to move the pointer to select AREA CODE.
- 3) Press **[select/channel]**. If an area code was already stored, the phone will display it.
- 4) Use the number keys ( **[0] – [9]** ) to enter the 3-digit area code.  
If you make an error, use **[delete/transfer]** to backspace.
- 5) Press **[select/channel]**. A confirmation tone sounds.
- 6) Press **[end]** or return the handset to the charging cradle to complete the setting. The handset returns to standby.

Auto Talk	:Off
CIDCW	:On
Area Code	:

Auto Talk	:Off
CIDCW	:On
Area Code	:■

## Choosing the Dialing Mode (HS1 only)

Your phone can communicate with the telephone network in two different ways: tone dialing and pulse dialing. These days, most telephone networks use a method called tone dialing, so your phone comes programmed for tone dialing by default.

If your phone company uses pulse dialing, you'll need to change your phone's dial mode. There's an easy way to tell: try making a call. If your call connects, your phone's setting is fine. If not, you may need to change the dial mode.

To change the dial mode:

- 1) When the phone is in standby, press and hold **[cid/menu]**. The following screen appears.

Auto Talk	:Off
CIDCW	:On
Area Code	:

- 2) Press **[vol/Δ/∇]** to move the pointer to select DIAL.
- 3) Press **[select/channel]** to set the phone to pulse dialing.
- 4) Press **[end]** and return the handset to the base unit to complete the setting. The handset returns to standby.

CIDCW	:On
Area Code	:
▶Dial	:Pulse

**Note:**

- If your phone system requires pulse dialing and you need to send the DTMF tones during a call, you can temporarily switch over to tone dialing. (Refer to "Tone Dialing Switch-over" on page 28.)
- To enable the setting change of Dialing Mode, you need to return the handset to the base unit when you complete the setting.

## Setting the Language

You can change the language the handset menu displays. Choose from English, French, or Spanish.

To change the language setting:

- 1) When the phone is in standby, Press and hold **[cid/menu]**. The following screen appears.
- 2) Press **[vol/Δ/∇]** to move the pointer to select LANGUAGE.
- 3) Press **[select/channel]** to select ENG, FR. or ESP.
- 4) Press **[end]** or return the handset to the charging cradle to complete the setting. The handset returns to standby.

▶Auto Talk	:Off
CIDCW	:On
Area Code	:

Area Code	:
Dial	:Tone
▶Language	:Eng

## Using the Speed Dial Memory

Your cordless phone allows you to store up to 10 names and numbers in each handset. You can dial these numbers with just a few key presses. The speed dial memory is not limited to phone numbers. You can store any number (up to 20 digits) that you need to enter once your call connects. This is referred to as Chain Dialing. An example is a frequently refilled prescription number. Store your pharmacy phone number in one speed dial and your most frequently refilled prescription number as another speed dial. To use, once you ring your pharmacy's automated prescription line, simply press **[memory]** and the speed dial number where you stored your prescription number and press **[select/channel]**.

**Note: When editing the speed dial memory, you must press a key within 30 seconds or the phone will return to standby. If you return the handset to the cradle, the phone will return to standby also.**

## Storing a Name and Number in Memory

- 1) With the phone in standby, press **[memory]**.
- 2) Enter **[0]** - **[9]** or use **[vol/Δ/∧]** and **[vol/Δ/∨]** to select the speed dial location where you would like to store this entry, and then press **[select/channel]** twice.
- 3) STORE NAME appears and a cursor flashes indicating that the phone is ready for the name to be entered.

**Note: If the selected speed dial number is already assigned, the Edit screen appears. You can select EDIT MEMORY to edit this entry, select DELETE MEMORY to erase this entry, or select GO BACK to choose another speed dial number.**

```
Select Memory
01
02 JOHN DOE
```

```
Store Name
█
```

```
▶ Edit Memory01
Delete Memory01
Go Back
```

4) Enter a name according to the instructions below, then press **[select/channel]**. If no name is required, go to step 5.

- The name can be up to 13 characters.
- Use **[#/tone/←]** and **[#/→]** to move the cursor to the desired location.
- Press **[delete/transfer]** to delete characters as needed or press and hold to delete all characters.

Refer to the letters on the number keys to select the desired characters.

With each press of a numeric key, the displayed character appears in the following order: upper case letters first, lower case letters next and finally the number corresponding to the key.

**Note: If the next character uses the same number key, you must press [#/→] to move the cursor over. Otherwise the next time you press the number key, it changes the character that was previously set.**

For example, to enter **Movies**.

- 1) Press **[6]** once. Then press **[#/→]** to move the cursor to the right.
- 2) Press **[6]** six times.
- 3) Press **[8]** six times.
- 4) Press **[4]** six times.
- 5) Press **[3]** five times.
- 6) Press **[7]** eight times.

keys	Number of times key is pressed								
	1	2	3	4	5	6	7	8	9
<b>1</b>	1								
<b>2abc</b>	A	B	C	a	b	c	2		
<b>3def</b>	D	E	F	d	e	f	3		
<b>4ghi</b>	G	H	I	g	h	i	4		
<b>5jkl</b>	J	K	L	j	k	l	5		
<b>6mno</b>	M	N	O	m	n	o	6		
<b>7pqrs</b>	P	Q	R	p	q	r	s	7	
<b>8tuvw</b>	T	U	V	t	u	v	8		
<b>9wxyz</b>	W	X	Y	Z	w	x	y	z	9
<b>0oper</b>	*	#	-	&	(	)	(blank)	0	

### If you make a mistake while entering a name

Use [\*/tone/←] or [#/->] to move the cursor to the incorrect character.

Press [delete/transfer] to erase the wrong character. Then enter the correct character. To delete all characters, press and hold [delete/transfer].

- 5) STORE NUMBER is displayed. The cursor flashes indicating that the phone is ready for the number to be entered.

```
Store Number
█
```

- 6) Use the keypad to enter the phone number; each number can be up to 20 digits. If you need the phone to pause during the dialing sequence, press [redial/pause] to insert a two-second delay between the numbers. You can enter multiple pauses to increase the delay. Each pause counts as a digit. The display shows a P for every pause.

```
Store Number
8007303456█
```

- 7) Press [memory]. You will hear a confirmation tone, and the following screen appears. Memory storage is complete.

```
Memory01 Stored
```

- 8) After about 2 seconds, the following screen displays all the speed dial memory entries.

```
01▶ Movies
02 JOHN DOE
03 MOM AND DAD
```

- 9) Press [end] to exit memory setup mode. The phone returns to standby.

**Note: When storing numbers into memory, if the handset is idle (i.e., no key is pressed) for more than 30 seconds, it will beep rapidly, and the phone will return to standby.**

## Storing Caller ID in Speed Dial Memory

Caller ID names and numbers shown in the Caller ID list can be stored in speed dial memory.

To store a caller id name/number to memory:

- 1) With the phone in standby, press **[cid/menu]**. Select the phone number to be stored from the Caller ID list by pressing **[vol/Δ/∧]** or **[vol/Δ/∨]**.
- 2) Press **[memory]**.
- 3) Enter a number ( **[0] – [9]** ) or press **[vol/Δ/∧]** or **[vol/Δ/∨]** to select the memory location to be stored.
- 4) Press **[select/channel]**. You hear a confirmation tone, and the number is stored in memory. The display returns to the Caller ID list.

### Note:

- If a number has already been stored in the selected memory number location, a confirmation screen is displayed. To overwrite, press **[vol/Δ/∧]** to YES and press **[select/channel]**. The display returns to the Caller ID list.
- You cannot store a Caller ID message if no phone number appears in the message.

```
5/17 12:30PM  
Jane Smith  
214-555-1234
```

```
Select Memory  
01  
02 JOHN DOE
```

```
5/17 12:30PM  
Jane Smith  
214-555-1234
```

```
Replace Memory?  
Yes  
▶ No
```

## Using Your Phone

### Making and Receiving Calls

	Handset on the cradle	Handset off the cradle
<b>Making a call</b>	1) Pick up the handset from the cradle. 2) Press <b>[talk/flash]</b> . 3) Listen for the dial tone. 4) Dial the number. OR 1) Pick up the handset from the cradle. 2) Dial the number. Then press <b>[talk/flash]</b> .	1) Press <b>[talk/flash]</b> . 2) Listen for the dial tone. 3) Dial the number. OR Dial the number. Then press <b>[talk/flash]</b> .
<b>Receiving a call</b>	1) Pick up the handset from the cradle. (If AutoTalk is on, the phone will answer the call when you pick it up.) 2) Press <b>[talk/flash]</b> .	Press <b>[talk/flash]</b> (or <b>[*/tone/←]</b> , <b>[#/→]</b> or any number key if AutoTalk is on).
<b>Hanging up</b>	Press <b>[end]</b> or return the handset to the cradle.	

**Note:** To turn on the AutoTalk feature, see "Activating AutoTalk" on page 15.

### Making a Call from Speed Dial Memory

To make a call from speed dial memory:

- 1) With the phone in standby, press **[memory]**. The handset displays your programmed speed dial number.

```

Select Memory
01 Movies
02 JOHN DOE
  
```



- 2) Enter the number ( [0] – [9] ), or press [vol/Δ/∧] or [vol/Δ/∨] to select the speed dial number you would like to dial.
- 3) Press [talk/flash]. CONNECTING changes to TALK, and the volume setting and the number selected appear on the display. Then the displayed number is dialed.

-Talk<  
8007303456

**Note: You can also press [talk/flash] before you access the speed dial memory. When you come to the phone number you want to dial, press [select/channel].**

### To cancel speed dialing

Press [end] to return to standby. If accessing the list during an active call, you can press [memory] to exit the list immediately. If no key is pressed for 30 seconds, the handset will exit the speed dial list automatically.

**Note: Pressing [end] to exit the speed dial list during a call will disconnect the call immediately.**

### Making a Call from the Caller ID List

You can place a call directly from the Caller ID list.

- 1) Press [cid/menu] in standby. Use [vol/Δ/∧] or [vol/Δ/∨] to select the phone number that you want to dial.
- 2) To have the phone dial a "1" before the displayed Caller ID number, press [1]. To have the phone dial the stored area code before the displayed Caller ID number, press [3].
- 3) Press [talk/flash]. The displayed phone number dials automatically.

5/17 12:30PM  
Jane Smith  
214-555-1234

**Note:**

- You can also press [talk/flash] before you access the Caller ID list. When you come to the phone number you want to dial, press [select/channel].
- You cannot make a call from the Caller ID list if your cordless telephone is connected to a private branch exchange (PBX).

## Transferring a Call

Your cordless phone allows you to transfer outside calls from one handset to another. Only one handset at a time can talk with an outside caller. While one handset is in use, the other cannot go off hook to listen to conversations or make an outgoing call.

### To transfer a call

- 1) During a call, press **[delete/transfer]**. The call will automatically be placed on hold and the transfer tone sounds.
- 2) When the other handset receives the call, the transfer tone stops.

Hold  
Transfer Call

To cancel the transfer and return to the caller, press **[delete/transfer]** or **[talk/flash]** on the handset.

### To receive a transfer call

Pick up the handset from the cradle (when AutoTalk is set to on), or pick up the handset and press **[talk/flash]** to answer the transferred call. Additionally, you can also answer the transferred call by pressing any number key, **[\*/tone/←]** or **[#/→]** (when AutoTalk is set to on).

Transfer Call

**Note: If you transfer a call and it is not picked up after 5 minutes, the call will be disconnected.**

## Redialing the Last Dialed Number

- 1) Pick up the handset from the cradle.
  - 2) Press **[talk/flash]**.
  - 3) Listen for the dial tone.
  - 4) Press **[redial/pause]**.
- OR
- 1) Pick up the handset from the cradle.
  - 2) Press **[redial/pause]**.
  - 3) Press **[talk/flash]**.

## Selecting the Ring Tone and Volume

Your phone has five different ringer tone/volume combinations you can choose from.

To select the ringer:

- 1) With the phone in standby, press **[vol/Δ/∧]** or **[vol/Δ/∨]**.
- 2) The phone will sound the different ring tones at different volumes. To turn the ringer off, select RINGER OFF.
- 3) When the phone sounds the ring tone and volume you wish to use, press **[end]**.

## Temporarily Mute Ringer

If the handset is off the base while an incoming call is ringing, simply press **[end]** to mute the incoming ring. The ringer will sound with the next incoming call.

**Note: You can only mute the handset ringer if the handset is off the base when the phone starts ringing.**

## Adjusting the Earpiece Volume

To change the earpiece volume, press **[vol/Δ/∧]** or **[vol/Δ/∨]** during a call.

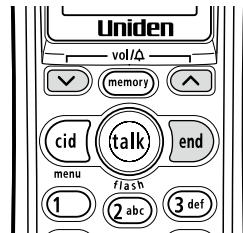

## Using Call Waiting

If you subscribe to Call Waiting through your local telephone company, you can receive calls while on the line.

To answer a call waiting call:

- 1) While on the phone, you will hear a call waiting tone. (If you have CIDCW service activated, you will see the name and number of the incoming caller. See page 29 for more information)
- 2) Press **[talk/flash]** to accept the waiting call. After a short pause, you will hear the new caller.
- 3) To return to the original caller, press **[talk/flash]** again.

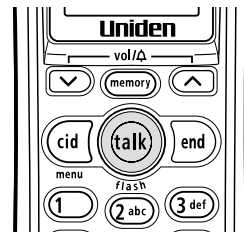

## Selecting a Different Channel

Your phone incorporates **UltraClear Plus™** true compander circuitry which virtually eliminates background noise. This innovative technology, together with 20 different channels, provides you with the best possible reception during all your conversations. If you happen to encounter interference while using your phone, you can manually change the phone's channel for clear operation. To change the channel during a call, press **[select/channel]**. SCANNING appears on the display, indicating the phone is changing to another channel. For more information on interference, refer to "Radio Interference" on page 42.

## Find Handset

To locate a lost handset, press **[find]** on the base. The handsets will beep for 60 seconds. The beeping will stop when any handset key is pressed or when **[find]** is pressed. The handset will also stop beeping automatically when an incoming call is received.

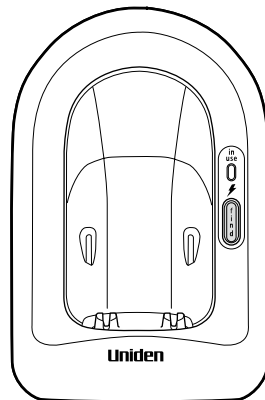

## Tone Dialing Switch-over

If your telephone company requires pulse dialing, you can temporarily switch over to tone dialing after the call connects. This feature is useful when you need tone dialing to use automated such as telephone bank tellers, telephone prescription refills, customer support menus, etc.

If your phone is set to pulse dialing mode, make your call normally. Once your call connects, press **[/tone/←]**. Any digits you enter from then on will be sent as tone dialing. When this particular call ends, the phone automatically returns to pulse dialing mode.

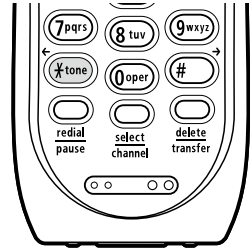

## Voice Mail Waiting Indicator

If you subscribe to voice mail service through your local telephone company, you can use your cordless telephone to access your voice mailbox. **The voice mail company will provide you with the access number.**

The **in use** LED on the base of your phone flashes whenever you have messages waiting in your voice mailbox.

### To access your voice mailbox

Just dial the access number supplied by your voice mail provider to enter your mailbox.

You can program your voice mail access number to a speed dial number.

If the voice mail waiting indicator remains on after you have retrieved your messages, press and hold **[find]** for 5 seconds. This will reset the indicator.

## Caller ID and CIDCW (Caller ID on Call Waiting)

You must subscribe to Caller ID services through your local telephone provider to use these features.

When the telephone rings, the Caller ID feature allows you to view the caller's name, phone number, date and time of call. The incoming call information is stored in the Caller ID record. If the Caller ID service includes the caller's name, the caller's name appears on the display (up to 15 letters).

The date and time received	5/11 12:30PM
Caller's name	Jane Smith
Caller's phone number	214-555-1234

You may receive any one of the following messages:

When invalid data is received	INCOMPLETE DATA
When a private name is received	PRIVATE NAME
When a private number is received	PRIVATE NUMBER
When an unknown name is received	UNKNOWN NAME
When an unknown number is received	UNKNOWN NUMBER

### Note:

- Data errors appear as "■".
- If you answer a call before the Caller ID message is received (for example, before the second ring), the Caller ID message will not appear.
- When the call is received via a telephone company that does not offer Caller ID service, the caller's phone number and name do not appear. (This includes international calls.)
- When the call is received via a private branch exchange (PBX), the caller's phone number and name may not appear.

## Caller ID on Call Waiting (CIDCW)

If you subscribe to CIDCW offered by your telephone company, you will hear a Call Waiting tone while you are on a call, and the Caller ID data will be displayed at the handset. To accept the waiting call, press **[talk/flash]** (see page 27).

**Note:** While you are on a call, the received Caller ID data is stored on the handset that is on a call only.

## Viewing the Caller ID Message List

The Caller ID list stores information for up to 30 incoming calls - even unanswered calls. You can also view the Caller ID list during a call.

- 1) Press **[cid/menu]**. The summary screen displays the number of new messages and total messages.
- 2) Use **[vol/Δ/∇]** to scroll through the messages from the latest to the earliest, or use **[vol/Δ/∇]** to scroll through the messages from the earliest to the latest.
- 3) Press **[cid/menu]** to return to the call, or press **[end]** to return to standby.

Caller ID New :01 Total:02
----------------------------------

5/17 12:30PM Jane Smith 214-555-1234
--

**Note:**

- In Caller ID operation, if no key is pressed for more than 30 seconds, an error tone sounds and the handset returns to standby.
- Each message can be up to 15 characters for the name and 15 digits for the phone number.
- The number of calls from the same Caller ID appears next to the received time. Once you view the new message, the number will be cleared and disappear.
- During a call, don't press **[end]**, or the call will be disconnected.

## Deleting Information from the Caller ID List

If the phone receives more Caller ID messages than it can store, the oldest one in the list is automatically deleted. Caller ID data can also be deleted manually.

### Deleting a Caller ID message

- 1) Press **[cid/menu]** in standby. Find the message to be deleted from the Caller ID list by pressing **[vol/Δ/∧]** or **[vol/Δ/∨]**.
- 2) Press **[delete/transfer]**.
- 3) Press **[vol/Δ/∧]** or **[vol/Δ/∨]** to select YES, and then press **[select/channel]**.

```
5/17 12:30PM
Jane Smith
214-555-1234
```

```
Delete Message?
▶ Yes
No
```

### Deleting all Caller ID names/numbers

- 1) With the phone in standby, press **[cid/menu]**.
- 2) Press **[delete/transfer]**.
- 3) Press **[vol/Δ/∧]** or **[vol/Δ/∨]** to select YES, and then press **[select/channel]**. You hear a confirmation tone and all stored Caller ID messages are deleted.

```
Caller ID
New :01
Total:02
```

```
Delete All?
▶ Yes
No
```

#### Note:

- While using the **DELETE ALL?** or **DELETE MESSAGE?** screen, if no key is pressed for more than 30 seconds, an error tone sounds, and the handset returns to standby.
- If you get an incoming call or page, the deleting operation is canceled and you can answer the call or page.



## Changing the Digital Security Code

To protect you against misbilled calls which might result from your phone being activated by other equipment, the cordless phone provides **AutoSecure**<sup>™</sup> (which electronically locks your phone when each handset is in the cradle) and **Random Code**<sup>™</sup> digital security which automatically selects one of over 262,000 digital security codes for each handset and the base. If the handset battery pack is completely discharged or the battery pack is removed, the digital security code will be lost. If this happens, a new security code is set automatically the next time the battery pack is charged. In the rare situation that you suspect another cordless telephone is using the same security code, you can change the code.

- 1) Pick up the handset from the cradle. Press and hold **[find handset]** on the base.
- 2) While holding **[find handset]**, place the handset in the base, and leave the handset in the base for more than 3 seconds.
- 3) Pick up the handset from the base. Then place the second handset in the base and wait for more than 3 seconds. No need to hold **[find handset]** this time.
- 4) Press **[talk/flash]** on one handset. Once you make sure TALK appears on the display, press **[end]**. Then, try with the other handset. If each handset displays TALK, a new security code is set. Otherwise, return to step 1 and try again.

## Maintenance Specifications

The phone complies with FCC Parts 15 and 68.

<b>Operating temperature</b>	-10°C to +50°C (+14°F to +122°F)		
<b>AC Adapter</b>		<b>For the base</b>	<b>For the charger</b>
	<b>Part number</b>	AD-0001	AD-310 or AD-1010
	<b>Input Voltage</b>	120V AC 60Hz	120V AC 60Hz
	<b>Output Voltage</b>	9V DC 210mA	9V DC 210mA
<b>Battery</b>	<b>Part number</b>	BT-1006	
	<b>Capacity</b>	500mAh, 3.6V	
<b>Frequency</b>	924.516925 - 926.704425 MHz 2,405.155942 - 2,411.718441 MHz		

**Note: To avoid damage to the phone use only Uniden AD-0001, AD-310 or AD-1010 and BT-1006 with your phone.**

Specifications, features, and availability of optional accessories are all subject to change without prior notice.

## Power Failure

During the period that the power is off, you will not be able to make or receive calls with the telephone.

## Talk and Standby Times

With average use, your handset battery provides approximately 6 hours of talk time and approximately 7 days of standby time. When your handset is not being used and is left off of the charging cradle the battery will gradually discharge. You can achieve optimum battery life and performance by returning the handset to the charging cradle after each use. If the handset is left off of the charging cradle, the actual talk time duration will be reduced respective to the amount of time the handset is off of the charging cradle.

## Low battery alert

When the battery pack is very low and needs to be charged, the phone is programmed to eliminate functions in order to save power. If the phone is not in use, LOW BATTERY appears on the LCD and none of the keys will operate. During a call, LOW BATTERY flashes and the handset beeps. Complete your conversation as quickly as possible and return the handset to the cradle for charging.

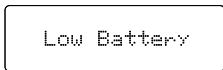

**Note: Information stored in the phone's memory will be retained for 30 minutes after the battery pack is removed. This includes all setup information, last number dialed, speed dial memory, and the CID list.**

Even when the battery pack is not being used, it will gradually discharge over a long period of time. For optimum performance, be sure to return the handset to the cradle after a telephone call.

## Battery replacement and handling

Recharge your phone on a regular basis by returning the handset to either cradle after each phone call. When the operating time becomes short even after a battery is recharged, please replace the battery. With normal usage, your battery should last about one year. To order replacement batteries, please contact Uniden's Parts Department. The contact information is listed on the back cover page.

### Warning:

**To avoid the risk of personal injury or property damage from fire or electrical shock, only use the Uniden battery model and Uniden adapter model specifically designated for this product.**

### Caution

- Use only the specified Uniden battery pack (BT-1006).
- Do not remove the battery from the handset to charge it.
- Never throw the battery into a fire, disassemble it, or heat it.
- Do not remove or damage the battery casing.

## Cleaning the battery charging contacts

To maintain a good charge, clean the charging contacts on the handset once a month. Dampen a cloth with plain water. Gently rub the damp cloth over the charging contacts until all visible dirt is removed. Dry the contacts thoroughly before returning the handset to the cradle.

### Caution

**Do not use paint thinner, alcohol, or other chemical products. Doing so may discolor the surface of the telephone and damage the finish.**

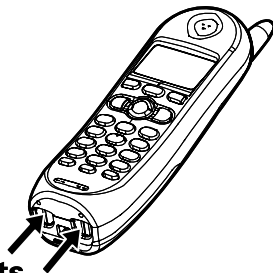

**Contacts**

## Troubleshooting

### Traveling Out-of-Range

During a call, as you begin to move your handset too far from your base unit, noise increases. If you pass the range limits of the base, your call will terminate within one minute.

### Common Issues

If your phone is not performing to your expectations, please try these simple steps first. If these steps do not solve your problem, please call our Customer Hotline. See back cover page for contact information.

Symptom	Suggestion
The <b>in use</b> LED or LED won't illuminate when the handset is placed in the cradle.	<ul style="list-style-type: none"><li>• Make sure the AC adapter is plugged into the cradle and wall outlet.</li><li>• Make sure the handset is properly seated in the cradle.</li><li>• Make sure the charging contacts on the handsets are clean.</li></ul>
The audio sounds weak and/or scratchy.	<ul style="list-style-type: none"><li>• Move the handset and/or base away from metal objects or appliances and try again.</li><li>• Press <b>[select/channel]</b> during a call to help eliminate background noise.</li><li>• Make sure that the handset is not too far from the base.</li></ul>

Symptom	Suggestion
Can't make or receive calls.	<ul style="list-style-type: none"> <li>• Re-register both handsets (see page 13).</li> <li>• Check both ends of telephone line cord.</li> <li>• Make sure the AC adapter is plugged into the base and wall outlet.</li> <li>• Disconnect the AC adapter for a few minutes, then reconnect it.</li> <li>• Change the digital security code (see page 32).</li> <li>• Make sure that the handset is not too far from the base.</li> <li>• Check the dialing mode used by your telephone company.</li> </ul>
The handset doesn't ring or receive a page.	<ul style="list-style-type: none"> <li>• Re-register both handsets (see page 13).</li> <li>• The battery pack may be weak. Charge the battery for 15-20 hours.</li> <li>• The handset may be too far away from the base unit.</li> <li>• Place the base unit away from appliances or metal objects.</li> <li>• Change the digital security code (see page 32).</li> <li>• Check the battery pack to ensure there is a secure connection.</li> <li>• Make sure ringer volume isn't set to "off."</li> </ul>
Severe noise interference.	<ul style="list-style-type: none"> <li>• Keep both handsets away from microwave ovens, computers, remote control toys, wireless microphones, alarm systems, intercoms, room monitors, fluorescent lights, and electrical appliances.</li> <li>• Move the base to another location or turn off the source of interference.</li> </ul>

Symptom	Suggestion
The Caller ID does not display.	<ul style="list-style-type: none"> <li>• The call was answered before the second ring.</li> <li>• The call was placed through a switchboard.</li> <li>• Charge the handset.</li> <li>• Your Caller ID service may not be active; contact your local telephone service provider.</li> </ul>
A handset is not working.	<ul style="list-style-type: none"> <li>• Make sure the battery pack is connected to the handset and fully charged.</li> <li>• Re-register the non-functional handset.</li> </ul>
Unavailable message is displayed on the LCD screen of the handset.	<ul style="list-style-type: none"> <li>• Make sure the other handset is not already in use. Both handsets cannot be in talk at the same time.</li> <li>• Place the handset in the base for at least 5 seconds to re-register to the base.</li> <li>• Make sure the handset is not too far from the base when trying to use.</li> </ul>
The handset doesn't communicate with the base or the other handset.	<ul style="list-style-type: none"> <li>• Re-register both handsets (see page 13).</li> </ul>
No 3- way conversation.	<ul style="list-style-type: none"> <li>• Only one handset at a time can talk with an outside caller. To allow the other handset to talk to the caller, transfer the call.</li> </ul>
Voice Message Indication does not work.	<ul style="list-style-type: none"> <li>• Contact your local telephone company to make sure that your telephone receives FSK message signaling.</li> <li>• Reset the indicator by pressing and holding <b>[find]</b> for 5 seconds.</li> </ul>

## Liquid Damage

Moisture and liquid can damage your cordless phone.

- If the handset or base is exposed to moisture or liquid, but only the exterior plastic housing is affected, wipe off the liquid, and use as normal.
- If moisture or liquid has entered the plastic housing (i.e. liquid can be heard in the phone or liquid has entered the handset battery compartment or vent openings on the base), follow the steps below:

Handset	Base
<ol style="list-style-type: none"><li>1) Remove the battery cover and leave it off for ventilation.</li><li>2) Disconnect the battery pack. Leave the battery cover off and the battery pack disconnected for at least 3 days.</li><li>3) Once the handset is completely dry, reconnect the battery pack and the battery cover.</li><li>4) Recharge the handset's battery pack for 15 to 20 hours before using.</li></ol>	<ol style="list-style-type: none"><li>1) Disconnect the AC adapter from the base, cutting off electrical power.</li><li>2) Disconnect the telephone cord from the base.</li><li>3) Let dry for at least 3 days.</li></ol>

### IMPORTANT:

You must unplug the telephone line while recharging the battery pack to avoid charge interruption.

### CAUTION:

DO NOT use a microwave oven to speed up the drying process. This will cause permanent damage to the handset, base and the microwave oven. After following these steps, if your cordless telephone does not work, please call our Customer Service Hotline. See back cover page for contact information.



## Precautions!

Before you read anything else, please note the following:

### Warning!

Uniden America Corporation DOES NOT represent this unit to be waterproof. To reduce the risk of fire, electrical shock, or damage to the unit, DO NOT expose this unit to rain or moisture.

### Rechargeable Nickel-Cadmium Battery Warning

- This equipment contains a rechargeable nickel-cadmium battery.
- Cadmium is a chemical known to the State of California to cause cancer.
- The rechargeable nickel-cadmium battery contained in this equipment may explode if disposed of in a fire.
- Do not short-circuit the battery.
- Do not charge the rechargeable nickel-cadmium battery used in this equipment in any charger other than the one designed to charge this battery as specified in the owner's manual. Using another charger may damage the battery or cause the battery to explode.

## Rechargeable Nickel-Cadmium Batteries Must Be Recycled or Disposed of Properly

- Uniden voluntarily participates in an RBRC® industry program to collect and recycle nickel-cadmium batteries at the end of their useful life, when taken out of service within the United States.
- The RBRC® program provides a convenient alternative to placing used nickel-cadmium batteries into the trash or municipal waste stream, which is illegal in some areas.
- Through the RBRC® program, Uniden makes it easy for you to drop off the used battery at local retailers of replacement nickel-cadmium batteries. You may also contact your local recycling center for information on where to return the used battery.

Please call 1-800-8-BATTERY for information on Ni-Cd battery recycling in your area. Uniden's involvement in this program is part of its commitment to protecting our environment and conserving natural resources.

- RBRC® is a registered trademark of the Rechargeable Battery Recycling Corporation.

Uniden works to reduce lead content in our PVC coated cords in our products and accessories.

### Warning!

The cords on this product and/or accessories contain lead, a chemical known to the State of California to cause birth defects or other reproductive harm. Wash hands after handling.



## Important Safety Instructions

When using your telephone equipment, basic safety precautions should always be followed to reduce the risk of fire, electric shock and injury to persons, including the following:

1. Do not use this product near water, for example, near a bath tub, wash bowl, kitchen sink or laundry tub, in a wet basement or near a swimming pool.
2. Avoid using a telephone (other than a cordless type) during an electrical storm. There may be a remote risk of electric shock from lightning.
3. Do not use the telephone to report a gas leak in the vicinity of the leak.
4. Use only the power cord and batteries indicated in this manual. Do not dispose of batteries in a fire. They may explode. Check with local authorities for possible battery disposal instructions.
5. Do not disassemble any component of this product.

## SAVE THESE INSTRUCTIONS

### CAUTION!

Risk of explosion if battery is replaced by an incorrect type. Dispose of used batteries according to the instructions. Do not open or mutilate the battery, and disconnect the battery before shipping this product.

## The FCC Wants You To Know

This equipment complies with Part 68 of the FCC rules and the requirements adopted by the ACTA.

On the bottom of this equipment is a label that contains, among other information, a product identifier in the format US:AAAEQ##TXXXX. If requested, this number must be provided to the telephone company.

An applicable Universal Service Order Codes (USOC) certification for the jacks used in this equipment is provided (i.e., RJ11C) in the packaging with each piece of approved terminal equipment. A plug and jack used to connect this equipment to the premises wiring and telephone network must comply with the applicable FCC Part 68 rules and requirements adopted by the ACTA.

A compliant telephone cord and modular plug is provided with this product. It is designed to be connected to a compatible modular jack that is also compliant. See installation instructions for details.

The REN is used to determine the number of devices that may be connected to a telephone line. Excessive RENs on a telephone line may result in the devices not ringing in response to an incoming call. In most but not all areas, the sum of RENs should not exceed five (5.0). To be certain of the number of devices that may be connected to a line, as determined by the total RENs, contact the telephone provider. For products approved after July 23, 2001, the REN for this product is part of the product identifier that has the format US:AAAEQ##TXXXX. The digits represented by ## are the REN without a decimal point (e.g., 03 is a REN of 0.3). For earlier products, the REN is separately

shown on the label.

If this equipment causes harm to the telephone network, the telephone company will notify you in advance that temporary discontinuance of service may be required. But if advance notice isn't practical, the telephone company will notify the customer as soon as possible. Also, you will be advised of your right to file a complaint with the FCC if you believe it is necessary. The telephone company may make changes in its facilities, equipment, operations or procedures that could affect the operation of the equipment. If this happens the telephone company will provide advance notice in order for you to make necessary modifications to maintain uninterrupted service. Please follow instructions for repairing, if any (e.g. battery replacement section); otherwise do not substitute or repair any parts of the device except as specified in this manual. Connection to party line service is subject to state tariffs. Contact the state public utility commission, public service commission or corporation commission for information. This equipment is hearing aid compatible.

Should you experience trouble with this equipment, please contact Uniden customer service at 800-297-1023. If the equipment is causing harm to the telephone network, the telephone company may request that you disconnect the equipment until the problem is resolved.

**NOTICE:** According to telephone company reports, AC electrical surges, typically resulting from lightning strikes, are very destructive to telephone equipment connected to AC power sources. To minimize damage from these types of surges, a surge arrester is recommended.

Changes or modifications to this product not expressly approved by Uniden, or operation of this product in any way

other than as detailed by the owner's manual, could void your authority to operate this product.

This device complies with part 15 of the FCC rules. Operation is subject to the following two conditions: (1) This device may not cause harmful interference, and (2) This device must accept any interference received, including interference that may cause undesired operation. Privacy of communications may not be ensured when using this phone.

To insure the safety of users, the FCC has established criteria for the amount of radio frequency energy various products may produce depending on their intended usage. This product has been tested and found to comply with the FCC's exposure criteria. For body worn operation, the FCC RF exposure guidelines were also met when used with the Uniden accessories supplied or designed for this product. Use of other accessories may not ensure compliance with FCC RF exposure guidelines and should be avoided.

### **Radio Interference**

Radio interference may occasionally cause buzzing and humming in your cordless handset, or caused by external sources such as TV, refrigerator, vacuum cleaner, fluorescent lighting, or electrical storm. Your unit is NOT DEFECTIVE. If these noises continue and are too distracting, please check around your home to see what appliances may be causing the problem. In addition, we recommend that the base not be plugged into a circuit that also powers a major appliance because of the potential for interference. Be certain that the antenna on the unit is fully extended when needed. In

the unlikely event that you consistently hear other voices or distracting transmissions on your phone, you may be receiving radio signals from another cordless telephone or other source of interference. If you cannot eliminate this type of interference, you need to change to a different channel. Finally, it should be noted that some cordless telephones operate at frequencies that may cause interference to nearby TVs and VCRs. To minimize or prevent such interference, the base of the cordless telephone should not be placed near or on top of a TV or VCR. If interference is experienced, moving the cordless telephone farther away from the TV or VCR will often reduce or eliminate the interference.

### **Cordless Telephone Privacy**

Cordless telephones are radio devices. Communications between the handset and base of your cordless telephone are accomplished by means of radio waves which are broadcast over the open airways. Because of the inherent physical properties of radio waves, your communications can be received by radio receiving devices other than your own cordless telephone unit. Consequently, any communications using your cordless telephone may not be private.

## **I.C. Notice Terminal Equipment**

**NOTICE:** This equipment meets the applicable Industry Canada Terminal Equipment Technical Specifications. This is confirmed by the registration number. The abbreviation, IC, before the registration number signifies that registration was performed based on a Declaration of Conformity indicating that Industry Canada technical specifications were met. It does not imply that Industry Canada approved the equipment

**NOTICE:** The Ringer Equivalence Number (REN) for this terminal equipment is marked on the equipment itself. The REN assigned to each terminal equipment provides an indication of the maximum number of terminals allowed to be connected to a telephone interface. The termination on an interface may consist of any combination of devices subject only to the requirement that the sum of the Ringer Equivalence Numbers of all the devices does not exceed five.

### **Radio Equipment**

The term "IC:" before the radio certification number only signifies that Industry Canada technical specifications were met. Operation is subject to the following two conditions: (1) this device may not cause interference, and (2) this device must accept any interference, including interference that may cause undesired operation of the device. "Privacy of communications may not be ensured when using this telephone".

## One Year Limited Warranty

Important: Evidence of original purchase is required for warranty service. **WARRANTOR: UNIDEN AMERICA CORPORATION ("Uniden") ELEMENTS OF WARRANTY:** Uniden warrants, for one year, to the original retail owner, this Uniden Product to be free from defects in materials and craftsmanship with only the limitations or exclusions set out below.

**WARRANTY DURATION:** This warranty to the original user shall terminate and be of no further effect 12 months after the date of original retail sale. The warranty is invalid if the Product is (A) damaged or not maintained as reasonable or necessary, (B) modified, altered, or used as part of any conversion kits, subassemblies, or any configurations not sold by Uniden, (C) improperly installed, (D) serviced or repaired by someone other than an authorized Uniden service center for a defect or malfunction covered by this warranty, (E) used in any conjunction with equipment or parts or as part of any system not manufactured by Uniden, or (F) installed or programmed by anyone other than as detailed by the owner's manual for this product.

**STATEMENT OF REMEDY:** In the event that the product does not conform to this warranty at any time while this warranty is in effect, warrantor will either, at its option, repair or replace the defective unit and return it to you without charge for parts, service, or any other cost (except shipping at its option, may replace the unit with a new or refurbished unit. **THE LIMITED WARRANTY SET FORTH ABOVE IS THE SOLE AND ENTIRE WARRANTY PERTAINING TO THE PRODUCT AND IS IN LIEU OF AND EXCLUDES ALL OTHER WARRANTIES OF**

**ANY NATURE WHATSOEVER, WHETHER EXPRESS, IMPLIED OR ARISING BY OPERATION OF LAW, INCLUDING, BUT NOT LIMITED TO ANY IMPLIED WARRANTIES OF MERCHANTABILITY OR FITNESS FOR A PARTICULAR PURPOSE. THIS WARRANTY DOES NOT COVER OR PROVIDE FOR THE REIMBURSEMENT OR PAYMENT OF INCIDENTAL OR CONSEQUENTIAL DAMAGES.** Some states do not allow this exclusion or limitation of incidental or consequential damages so the above limitation or exclusion may not apply to you.

**LEGAL REMEDIES:** This warranty gives you specific legal rights, and you may also have other rights which vary from state to state. This warranty is void outside the United States of America and Canada. **PROCEDURE FOR OBTAINING PERFORMANCE OF WARRANTY:** If, after following the instructions in the owner's manual you are certain that the Product is defective, pack the Product carefully (preferably in its original packaging). Disconnect the battery from the Product and separately secure the battery in its own separate packaging within the shipping carton. The Product should include all parts and accessories originally packaged with the Product. Include evidence of original purchase and a note describing the defect that has caused you to return it. The Product should be shipped freight prepaid, by traceable means, to warrantor at:

Uniden America Service  
4700 Amon Carter Blvd.  
Fort Worth, TX 76155

# Index

<b>A</b>		<b>D</b>		<b>S</b>	
AC adapter information.....	33	Dial mode .....	17	Speed dial memory	
		Digital security code .....	32	Making calls from speed dial	
				memory.....	23
<b>B</b>		<b>E, F, G, H</b>		Storing names and numbers in	
Basic setup.....	15	Earpiece volume.....	26	speed dial memory .....	19
Battery pack		Find handset.....	27		
Information.....	33			<b>T, U</b>	
Installing .....	8	<b>I, J, K, L</b>		Talk and standby times .....	34
Preparing and charging .....	8, 9	Installing the phone .....	7	Technical information.....	33
Replacement and handling.....	35	Interference .....	42	Tone dialing switch-over .....	28
		Liquid damage .....	39	Transferring a Call .....	25
<b>C</b>				Traveling out-of-range .....	36
Call waiting .....	27	<b>M, N, O, P, Q</b>		Troubleshooting.....	36
Caller ID service .....	29	Maintenance.....	33		
Caller ID on call waiting .....	30	Making a call.....	23	<b>V, W, X, Y, Z</b>	
Deleting .....	31	Precautions.....	40	Voice mail waiting indicator .....	28
Making a call.....	24			Wall mounting.....	11
Viewing .....	30	<b>R</b>		Warranty .....	44
Channel .....	27	Receiving a call .....	23		
Charging the battery pack .....	9	Redial .....	26		
Cleaning contacts .....	35	Register handsets.....	13		
Connect the cradle .....	9	Ringer tone and volume .....	26		
Controls and functions.....	5, 6				

## At Uniden, we'll take care of you!

Thank you for purchasing a Uniden product. If you have any questions or problems,  
**please do not return this product to the place of purchase.**

<b>Having Trouble?</b>	Our customer care specialists are here to help you! Visit our website at <b>www.uniden.com</b> or call our Customer Hotline at <b>1-800-297-1023</b> during regular business hours.*
<b>Need a Part?</b>	To order headsets, additional handsets, replacement batteries or other accessories, visit our website at <b>www.uniden.com</b> or call <b>1-800-554-3988</b> during regular business hours.*
<b>Help for our Special Needs Customers</b>	If you need special assistance due to a disability or have questions on the accessibility features of this product, please call <b>1-800-874-9314 (voice or TTY)</b> .

\* Central Standard Time. Detailed customer service hours are available at [www.uniden.com](http://www.uniden.com).

May be covered under one or more of the following U.S. patents:  
4,797,916 5,426,690 5,434,905 5,491,745 5,493,605 5,533,010  
5,574,727 5,581,598 5,650,790 5,660,269 5,661,780 5,663,981  
5,671,248 5,696,471 5,717,312 5,732,355 5,754,407 5,758,289  
5,768,345 5,787,356 5,794,152 5,801,466 5,825,161 5,864,619  
5,893,034 5,912,968 5,915,227 5,929,598 5,930,720 5,960,358  
5,987,330 6,044,281 6,070,082 6,125,277 6,253,088 6,314,278  
6,418,209 6,618,015 6,671,315 6,714,630 6,782,098 6,788,920  
6,788,953 6,839,550 6,889,184 6,901,271 6,907,094 6,914,940  
6,953,118 7,023,176  
Other patents pending.

**VISIT  
WWW.UNIDEN.COM  
TO REGISTER YOUR  
PRODUCT**

© 2007 Uniden America Corporation, Fort Worth, Texas. Contains additional foreign articles. Printed in China.



## Free Manuals Download Website

<http://myh66.com>

<http://usermanuals.us>

<http://www.somanuals.com>

<http://www.4manuals.cc>

<http://www.manual-lib.com>

<http://www.404manual.com>

<http://www.luxmanual.com>

<http://aubethermostatmanual.com>

Golf course search by state

<http://golfingnear.com>

Email search by domain

<http://emailbydomain.com>

Auto manuals search

<http://auto.somanuals.com>

TV manuals search

<http://tv.somanuals.com>