

Uniden®

ELBT 595

SERIES

OWNER'S

MANUAL

OWNER'S MANUAL

Contents

Welcome/Features/Terminology/Accessibility	2	Registering a Mobile Phone to the Main Base Unit	38	Changing the sorting order	68
Controls & Functions	4	Using Bluetooth Headset (Handset Only)	44	Naming phonebook groups	69
Setting up the Phone	6	Using Your Phone	48	Making Calls with the Phonebook	69
Choose the best location	6	Making Calls Using the Land Line	48	Caller ID Features	70
Battery Backup Feature	7	Receiving a call/AutoTalk set to Off	50	Using the Caller ID List	70
Install the rechargeable battery pack	8	Hanging Up	51	Deleting Caller ID numbers	71
Low battery alert	9	Switching to the Handset Speakerphone During a Call	51	Answering Machine Features	72
Cleaning the battery charging contacts	9	Moving out of range	51	Setting Up the Answering Machine	73
Connect the base and charge the handset	10	Call Waiting	52	Setting Your Outgoing Greeting	76
Mounting the Base Unit on a Wall	11	Call Waiting Deluxe	52	Using the Answering Machine	77
Standard wall plate mounting	11	Placing a Call on Hold	53	Recording a phone conversation	79
Expanding Your Phone	12	Conferecing	53	Screening Calls	79
Backwards/Forwards Compatibility	12	Mobile Line Transfer	55	Do Not Disturb (DND)	80
Connect the expansion handset's charger	13	Redialing Calls	56	Remote Operation	81
Register the Handset	13	Adjusting Base Ringer and Speaker Volumes	57	Multi-Handset Features	83
Register expansion handsets to the main base	14	Using the Handset Volume Setting Menu	58	Using DirectLink Mode	83
Changing the Digital Security Code	15	Mute	59	Room/Baby Monitor	84
Installing the Holster	15	Mute the Microphone	59	Intercom	85
Optional Headset Installation	16	Tone Dialing Switch Over	60	Transferring a Call	86
Installing Uniden's Cordless Telephone Customization Tool	17	Privacy Mode	60	Note on Power Sources	87
Using the Interface	18	Find Handset	60	Power Failure	87
Display Icons	19	Reminder (Handset only)	61	Battery replacement and handling	87
Soft Key Function	20	Using the Phonebook	63	Warning	87
Entering text	22	Creating and Editing Phonebook Entries	63	General Information	88
Main Menu Options	23	Storing Caller ID or Redial Numbers in the Phonebook	66	AC Adapter Information	88
System Setup Menu	24	Storing and Editing Numbers from the Dial Operation	66	Battery Information	88
Global Setup	28	Managing the Phonebook	67	Troubleshooting	89
Setting the Ringer Options	30	Checking the number of stored entries	68	Bluetooth Troubleshooting	91
Display Settings (Handset Only)	35			System Reset	93
Using the Bluetooth Feature	38			Liquid Damage	94
				Precautions & Warranty	95
				I.C. Notice	97
				Index	98
				Remote Operation Card	100

Welcome

Thank you for purchasing a Uniden Multi-Handset phone. This phone is compatible with Bluetooth enabled mobile telephones and headsets. The USB connection lets you use your personal computer to edit your phonebook, download schedule reminders, and even import contacts from Microsoft® Outlook®.

Note: Illustrations in this manual are used for explanation purposes. Some illustrations in this manual may differ from the actual unit.



As an Energy Star® Partner, Uniden has determined that this product or product models meets the Energy Star® guidelines for energy efficiency. Energy Star® is a U.S. registered mark.

Features

- 5.8GHz Digital Expandable
- Compatible with Bluetooth Enabled Mobile Handsets/Headsets
- Integrated Answering Device
- Caller ID/Call Waiting Deluxe Options
- Customize Handset Profiles Using Personal Computer
- 100 Phonebook Names (4 Numbers Per Name)
- Downloadable Images
- Recordable Ringer Tones
- Calendar with Schedule Reminder Capability
- Battery Backup During Power Failure

Uniden® is a registered trademark of Uniden America Corporation. AutoStandby, DirectLink, IntegriSound and Random Code are trademarks of Uniden America.

Microsoft and Windows are either registered trademarks or trademarks of Microsoft Corporation in the United States and/or other countries.

BLUETOOTH trademarks are owned by their proprietor and used by Uniden America Corporation under license.

NOKIA is a registered trademark of Nokia Corporation. MOTOROLA is a registered trademark of Motorola, Inc. PLANTRONICS is a registered trademark of Plantronics, Inc. All product or service names are the property of their respective owners.

Portions of this product were created using LEADTOOLS ©1991-2002, LEAD Technologies, Inc. ALL RIGHTS RESERVED.

Terminology

- **Standby mode:** The handset is not in use. If it is off the cradle, no line has been activated. No dial tone is present.
- **Talk mode:** A telephone line has been activated on the handset, enabling a dial tone.

Accessibility

Uniden provides a customer service hotline for accessibility questions. If you have a disability and need customer service assistance or if you have any questions about how Uniden's products can accommodate persons with disabilities, please call the accessibility voice/TTY line:
1-800-874-9314

A representative is available to talk to you M-F, 8:00 am to 5:00 pm, CST. After hours, you can leave us a message, and we will call you back. Information is also available on our website, www.uniden.com, under the "Accessibility" link.

Controls & Functions

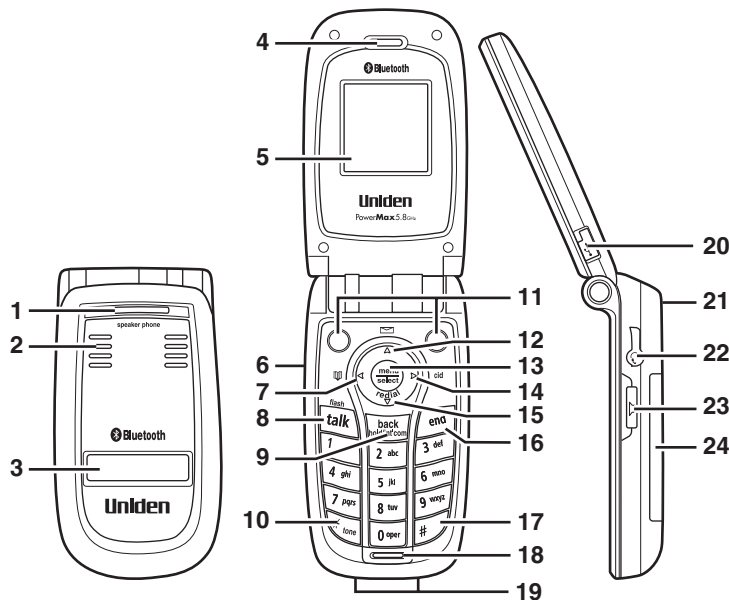

1. New Message LED
2. Speakerphone Speaker and Ringer
3. Sub LCD
4. Handset Earpiece
5. LCD display
6. Speaker Volume up/down key (P. 59)
7. ☰ (phonebook)/◀ (P. 63 & 21)
8. Talk/flash (P. 48 & 52)
9. Back/hold/int'com (intercom)
(P. 21 & 53 & 85)
10. */tone (P. 60)
11. Soft menu keys (P. 20)
12. ✉ (message)/△ (P. 78 & 21)
13. Menu/select (P. 21)
14. CID (Caller ID) /▷ (P. 70 & 21)
15. Redial/▽ (P. 56 & 21)
16. End (P. 51)
17. # (P. 71)
18. Handset Microphone
19. Handset Charging Contacts
20. USB jack cover
21. Handset Antenna
22. Headset Jack Cover
23. ▷ (speaker phone) (P. 49)
24. Handset Battery Compartment

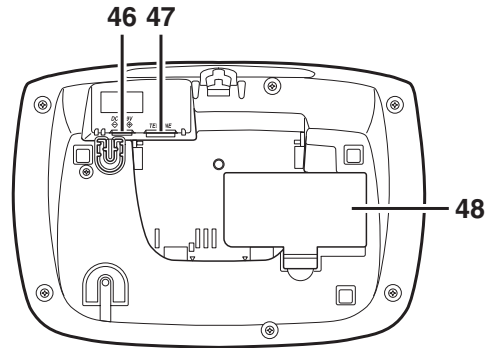
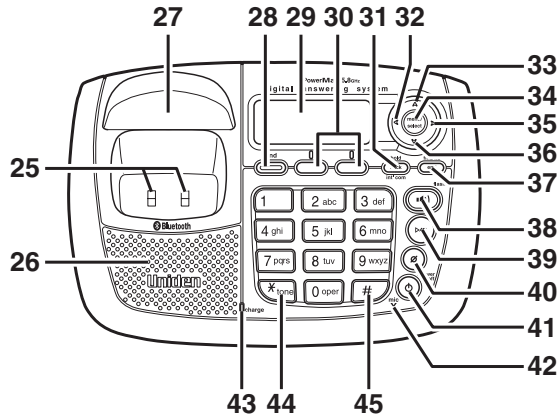

- 25. Base Charge Contacts
- 26. Base Speaker
- 27. Base Antenna
- 28. Dnd (do not disturb) (P. 80)
- 29. LCD Display
- 30. Soft keys (P. 20)
- 31. Back/hold/int'com (intercom)
(P. 21 & 53 & 85)
- 32. Phonebook/< key (P. 63 & 22)

- 33. Δ Speaker Volume up (P. 57)
- 34. Menu/select (P. 21)
- 35. Cid (Caller ID)/> (P. 22 & 70)
- 36. ∇ Speaker Volume down (P. 57)
- 37. End/find hs (P. 51)
- 38. M (speaker)/flash (P. 50 & 52)
- 39. P (play/stop) (P. 78)
- 40. X (delete) (P. 78)
- 41. O answer on/off (P. 77)

- 42. Base Microphone
- 43. Handset Charge LED
- 44. */tone (P. 60)
- 45. # (P. 71)
- 46. DC IN 9V Jack
- 47. TEL LINE Jack
- 48. Base Battery Compartment



For maximum range:

- Do not hold the handset where you would block the signal.

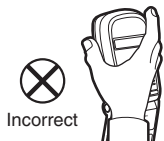
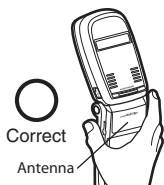

- Metal and reinforced concrete may affect cordless telephone performance.

Setting up the Phone

Choose the best location

When choosing a location for your new phone, here are some important guidelines you should consider:

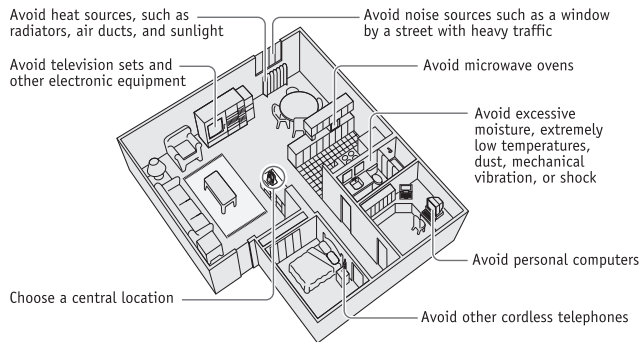

- The location should be close to both a phone jack and a continuous power outlet (one which is not connected to a switch).
- The base and handset should be kept away from sources of electrical noise such as motors, microwave ovens, and fluorescent lighting.
- For better reception, place the base as high as possible.
- The base should be placed in an open area for optimum range and reception.
- If your home has specially wired alarm equipment connected to phone line, be sure that installing the system does not disable your alarm equipment. If you have questions about what will disable alarm equipment, contact your telephone company or a qualified installer.

Battery Backup Feature

The battery backup allows you to make and receive calls during a power failure. You can use any handset or the base, just as you would normally.

Install the backup battery in the base

- 1) Open the battery case cover by pressing the release button on the bottom of the base as shown.
- 2) Plug the battery connector (red and black wires) into the jack inside the battery compartment. (The connector notches fit into the grooves of the jack only one way). Match the wire colors to the polarity label in the battery compartment, connect the battery and listen for a click to insure connection.
- 3) Make sure you have a good connection by gently pulling on the battery wires. If the connection is secure, the battery jack will remain in place.
- 4) Place the battery case cover back on the base.
- 5) Align the tabs on the cover with the grooves on the base, and press down the cover until it clicks into place.

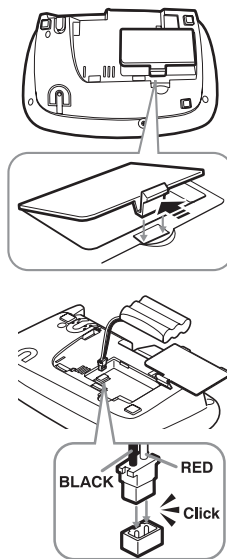

-  appears in LCD as a warning that battery backup pack is NOT installed in the base unit.
- To use the Battery Backup Feature, you need to connect the AC adapter to the base and charge the base battery at least for 24 hours.
- During initial setup, the AC Adapter must be connected to activate the base unit. Once activated, you can make or receive call using the backup battery.
- Use only the Uniden (BT-446) rechargeable battery pack supplied with your cordless telephone.



Use only the Uniden (BT-0002) rechargeable battery pack supplied with your cordless telephone.

Install the rechargeable battery pack

Follow the steps below if you need to install a battery.

- 1) Press down on the handset battery case cover (use the finger indentation for a better grip) and slide the cover downward to remove.
- 2) Place the battery pack in the battery compartment with the connectors on the battery and on the compartment aligned.
- 3) Place the battery case cover back on the handset and slide it upwards until it clicks into place.

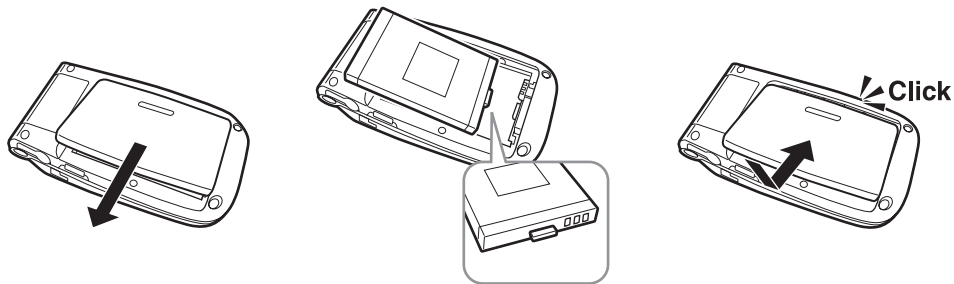

Low battery alert

When the battery pack is very low, the phone is programmed to eliminate functions in order to save power.

The battery pack needs to be charged when

- The empty battery icon appears.
- Low Battery appears in the display.

If the phone is in standby mode, none of the keys will operate. If you are on a call, complete your conversation as quickly as possible, and return the handset to the cradle.

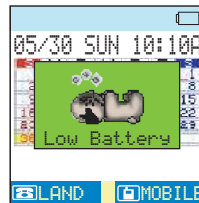

Cleaning the battery charging contacts

To maintain a good charge, clean the charging contacts on the handset once a month. Dampen a cloth with plain water. Gently rub the damp cloth over the charging contacts until all visible dirt is removed. Dry the contacts thoroughly before returning the handset to the cradle.

Caution: Do not use paint thinner, benzene, alcohol, or other chemical products. Doing so may discolor the surface of the telephone and damage the finish.

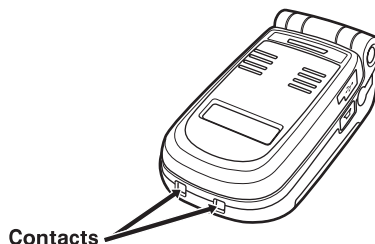

- Even when the battery pack is not being used, it will gradually discharge over a long period of time.
- For optimum performance, be sure to return the handset to the cradle after each telephone call.
- If the handset is left off of the base, the actual talk mode duration will be reduced respective to the amount of time the handset is off the cradle.



• Use only the supplied AD-0009 AC adapter. Do not use any other AC adapter.

• Do not place the power cord where it creates a trip hazard or where it could become chafed and create a fire or electrical hazard.

• Don't place the base in direct sunlight or subject it to high temperatures. The battery may not charge properly.



If your telephone outlet isn't modular, contact your telephone company.

Connect the base and charge the handset

1) Connect the AC adapter to the **DC IN 9V** jack.

Place the base close to the AC outlet to avoid long extension cords.

2) Connect the AC adapter to a continuous power supply (i.e., an outlet that is not controlled by a switch).

3) Close the handset and place it in the base with the smaller LCD screen facing forward.

4) Make sure that the **charge** LED illuminates.

If the LED does not illuminate, check to see that the AC adapter is plugged in and the handset makes good contact with the base charging contacts.

5) **Charge your handset at least 10 hours before plugging into the phone line.**

6) Once the handset battery pack is fully charged, connect the telephone line cord to the **TEL LINE** jack and to a telephone outlet.

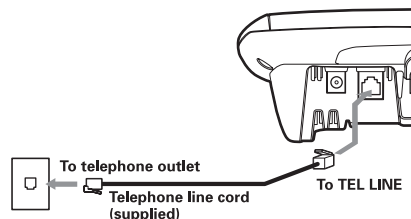
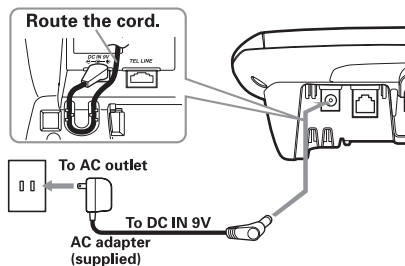

Mounting the Base Unit on a Wall

Standard wall plate mounting

This phone can be mounted on any standard wall plate.

- 1) Snap the wall mount adapter into the notches on the base top.
- 2) Plug the AC adapter into the DC IN 9V jack.
- 3) Wrap the AC adapter cord inside the molded wiring channel as shown.
- 4) Plug the AC adapter into a standard 120V AC wall outlet.
- 5) Plug the telephone line cord into the TEL LINE jack.
Wrap the cord inside the molded wiring channel as shown.
- 6) Plug the telephone line cord into the telephone outlet.
- 7) Align the mounting slots on the base with the mounting posts on the wall. Then push in and down until the phone is firmly seated.

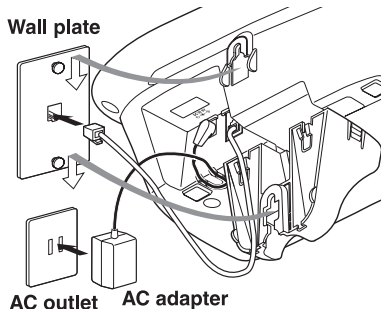
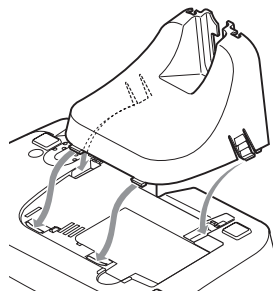

DO NOT use an AC outlet controlled by a wall switch.



- Advanced features may not be supported by older handsets.
- If you have any trouble with your phone, visit our web site at www.uniden.com or call our Customer Hotline (see back cover page).

Expanding Your Phone

Your phone can support a total of ten handsets. Expansion handsets do not need to be connected to a phone jack. Expansion handsets allow you to use additional features such as DirectLink Mode and up to 5-way conference calling. Expansion handsets need to be registered to the base before they will operate.



Backwards/Forwards Compatibility

Your phone is compatible with other Uniden 5.8GHz Digital Expandable Handsets. Compatible models include the **TCX860** and **ELX500**. (please check www.uniden.com for an updated list of expansion handset compatible with this series.)



Connect the expansion handset's charger

The handset is powered by a rechargeable battery pack. The battery recharges automatically when the handset is placed in the charger.

- 1) Connect the AC adapter to the DC IN 9V jack and to a standard 120V AC wall outlet.
- 2) Set the charger on a desk or tabletop, and place the handset in the charger with the Sub-LCD screen facing forward.
- 3) Make sure that the **charge** LED illuminates. If the LED does not illuminate, check to see that the AC adapter is plugged in and the handset makes good contact with the charger charging contacts.
- 4) Charge the handset battery pack for at least 10 hours before using your new cordless telephone for the first time.

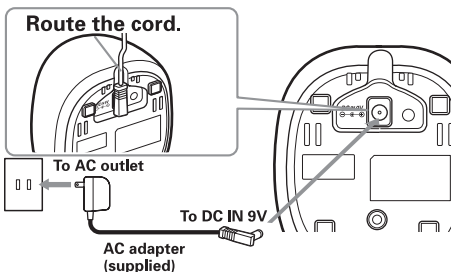

•Use only the supplied AD-0005 AC adapter. Do not use any other AC adapter.

•Your phone maybe compatible with other Uniden 5.8Ghz Digital Expandable Systems. Look for the technology icon on our boxes or visit our website for a list of compatible models.

Register the Handset

Handsets supplied with the phone are registered to the base by the factory. Pre-registered handset display a handset ID number. Handsets that have not been registered display **MUST** place handset in base to register! Models may vary, refer to Owners Manual for help. in the LCD. and Handset must be registered in the sub LCD. When you register an extra handset to the base, the handset ID will be assigned. Only one handset can be registered at a time.

Register expansion handsets to the main base

Before the expansion handset is registered, the battery pack MUST be charged for **10 hours**.

To register an ELX500 handset, simply place it in the main base.

To register a TCX860 handset, follow the steps below:

- 1) From the base, press *menu/select* and select System Setup menu.
- 2) Select Register Handset, and press *menu/select*.
- 3) On the handset, press and hold # until you hear a beep.



While the handset is registering, Handset Registering will appear in the LCD. When Registration complete. is displayed, the handset has been registered to the base. If Registration failed. appears, please try these steps again.

Changing the Digital Security Code

The digital security code is an identification code used to connect the handset and the base unit. Normally, setting the code is not necessary. In the rare situation that you suspect another cordless telephone is using the same security code, you can change the code. To change the digital security code:

1. De-register all the handsets you have (see page 93).
2. Re-register each handset by following the steps on page 14.

Installing the Holster

- Line up the groove on the back of the handset with the groove on the holster. The handset fits in the holster only one way.
- Slide the phone into the holster.
- Use the spring clip to attach the holster to your belt or pocket.

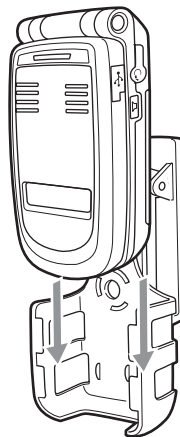

You must remove the holster to charge the handset.



To use with a Bluetooth® headset, see page 44.

Optional Headset Installation

Your phone may be used with an optional headset. To use an optional headset, insert the headset plug into the headset jack. Your phone is ready for hands-free conversations. Headsets may be purchased by calling Uniden's Parts Department (see back cover page).

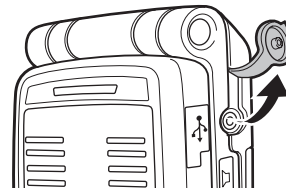

Installing Uniden's Cordless Telephone Customization Tool

This phone includes Uniden's Cordless Telephone Customization Tool for your Windows PC. You can use this software application to completely configure your phone, download pictures for wallpaper, and import contacts from Microsoft® Outlook®.

NOTE: Uniden's Cordless Telephone Customization Tool application requires Microsoft®, Windows® 98SE, Windows ME, Windows 2000, Windows XP and more than 150MB free hard drive space.

- 1) Insert the Cordless Telephone Customization Tool CD into your computer's CD-ROM drive. The installation application should start automatically.
 - 2) If the application doesn't start, go to the **Start** menu and select **Run**.
 - 3) In the window, type **d:\autorun.exe** (where **d** is the letter assigned to your CD-ROM drive), and click **OK**.
 - 4) Once the software is installed, connect the USB cable to the handset and your PC as shown.
 - 5) Customize your Uniden Cordless Handset.
- For complete instructions on using Uniden's Cordless Telephone Customization Tool, see the help file on the CD-ROM.

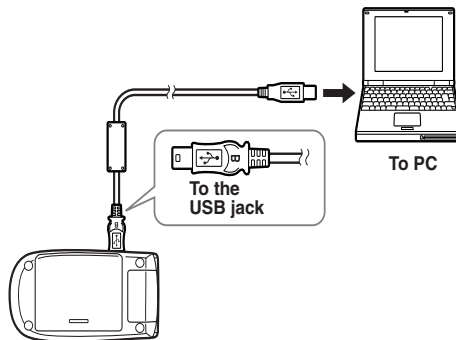

Using the Interface

Example of the standby mode display

• Handset

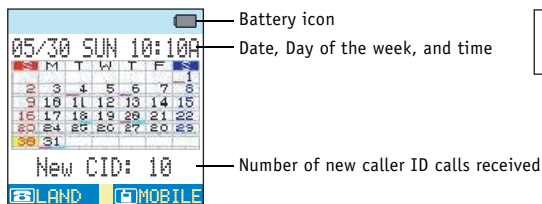

• Sub-LCD

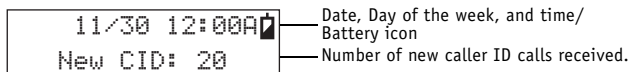

• Base

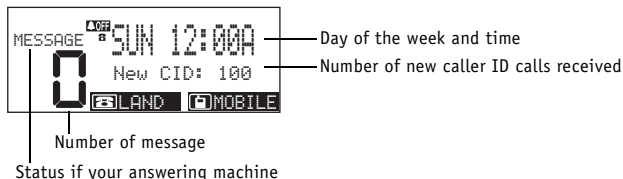

NEW — appears if you have a new message.

FULL — appears when the message storage is full.

Announce ONLY — appears if you set your answering system to announce only.

Display Icons

ICON			DESCRIPTION
Handset	Sub-LCD	Base	
		-	Battery icons indicate the handset battery status. This icon cycles depending on the battery status (empty, low, medium, and full).
			Ringer off icon indicates that ringer is turned off.
			LAND line icon indicates that the land line is in use.
			MOBILE line icon indicates that the mobile line is in use.
	-		Bluetooth icon appears when you are using bluetooth features.
	M	M	Mute icon appears when you mute the handset or the base.
		-	Speaker icon appears when the handset speaker phone is used.
	-	-	When a new message is received, an envelope icon is displayed on the LCD screen
P	P	P	Privacy icon appears when the Privacy Mode is turned on.
	R		Call record icon appears while recording a conversation.

Soft Key Function

"Soft" keys are keys that change function during the operation of the phone. There are two soft keys on the handset and base.

The text right above the soft key indicates that key's current function. For example, when the phone is in standby mode, pressing soft key 1 activates the LAND line. When the phone is in talk mode, pressing soft key 1 brings up the options menu. Complete information on the features controlled by the soft keys can be found under each feature.

In standby mode

Handset



Soft key 1 Soft key 2

In talk mode

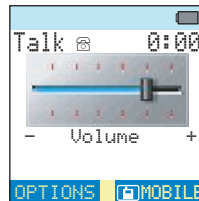

Soft key 1 Soft key 2

Base



Soft key 1 Soft key 2



Soft key 1 Soft key 2

To make menu selections, please follow the instructions below:

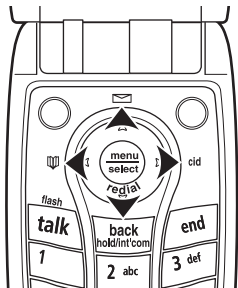

Press **menu/select**.

Highlight the option you want by pressing the up, down, right, or left key on the handset, or up or down key on the base. This will move the cursor; the option currently highlighted appears in reversed out text.

Select the highlighted option by pressing the **menu/select** key.

To exit the menu and return to standby, press the **end** key on the handset or the **end/find hs** key on the base.

To go back a level in the menu, press the **back/hold/int'com**.



Entering text

You can use the number keypad on your phone to enter text by referring to the letters printed on each number key. When you press the number key in a text entry field, the phone displays the first letter printed on the number key. Press the number key twice to display the second letter and three times to display the third. Capital letters are displayed first, then lower case letters, then the number on the key.

If two letters in a row use the same number key, enter the first letter, then use the right and left key to move the cursor to the next position to enter the second letter.

For example, to enter Movies:

- 1) Press 6 once to enter M.
- 2) Use right or left key to move the cursor to the right.
- 3) Press 6 six times to enter o.
- 4) Press 8 six times to enter v.
- 5) Press 4 six times to enter i.
- 6) Press 3 five times to enter e.
- 7) Press 7 eight times to enter s.
- 8) Press **menu/select** to end your text entry.

If you make a mistake while entering a name, use right or left key to move the cursor to the incorrect character. Press the **DELETE** soft key to erase the incorrect character, and then enter the correct character. To delete all characters in the text entry field, press and hold the **DELETE** soft key.

	Number of times key is pressed								
keys	1	2	3	4	5	6	7	8	9
1	1								
2 abc	A	B	C	a	b	c	2		
3 def	D	E	F	d	e	f	3		
4 ghi	G	H	I	g	h	i	4		
5 jkl	J	K	L	j	k	l	5		
6 mno	M	N	O	m	n	o	6		
7 pqrs	P	Q	R	S	P	q	r	s	7
8 tuv	T	U	V	t	u	v	8		
9 wxyz	W	X	Y	Z	w	x	y	z	9
	&	<	>	<	>	/	(blank)	--	--
0 oper	.	,	:	?	!	@	'	"	*
	#	0							

Main Menu Options

On the handset, the options are **DirectLink, Room Monitor, Messages, Reminder, Speaker Setup, Display Options, Ringer Options, System Setup and Bluetooth.**

Note:

- If you do not press a key within 30 seconds, the phone will time out and exit the menu mode. When setting Date and Time, the time-out period is extended to two minutes.
- All of these options can be configured in the Cordless Customization Application.



Handset Main Menu Options



Direct Link



Room Monitor



Messages



Ringer Options



Speaker Setup



Display Options



Reminder



System Setup



Bluetooth

On the base, the options are **Rings/Volumes, Caller ID, Redial, Phonebook, Room Monitor, Record Memo, System Setup, and Reconnect** .

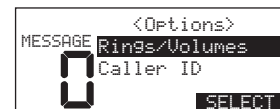



Through this section we use handset display images for explanation.

Handset/Base



(System Setup)

Handset
(Base)

Mobile
Priority

System Setup Menu

System Setup

The following submenu options must be set separately for each handset and the base.



Mobile Priority

Mobile Priority allows you to set a default mobile phone for the base and each handset. The priority mobile phone is automatically used when you press the **MOBILE** soft key to make a call.

If you select a priority mobile phone, the handset or base will ring when the priority mobile receives a call. If the non-priority mobile phone receives a call, the handset or base displays *incoming call*, but it will not ring. If you want a handset or base to ring when any paired mobile phone receives a call, set the mobile priority to **All**.

 The handset and base will still ring when a land line call is received.

To set the mobile priority, go to **Mobile Priority**, and select a mobile or **All** from the list. A confirmation tone tells you that the setting is active.

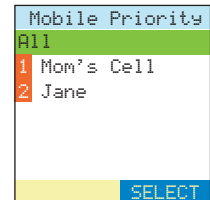

LCD Contrast (For Base)

You can change the contrast of your base display to make it easier to read. You might want to adjust the contrast whenever you change the display color. Your phone gives you 10 levels of contrast to choose from. To adjust the contrast, go to **LCD Contrast**. Use up or right key to increase the contrast and down or left key to decrease the contrast. When you like the level of contrast, press **menu/select** to select it.

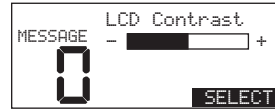

Open to Answer (Handset only)

Open to Answer lets you answer the phone by opening the cover of the handset. To turn on Open to Answer, go to **Open to Answer** and select **On**. A confirmation tone tells you that Open to Answer is active.

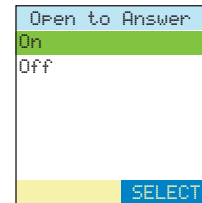

Any Key Answer (Handset only)

Any Key Answer lets you answer the phone by pressing any key on the number pad. To turn on Any Key Answer, go to **Any Key Answer** and select **On**. A confirmation tone tells you that Any Key Answer is active.

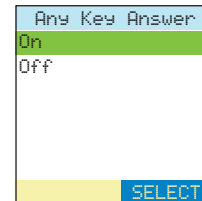

(System Setup)

Handset (Base)

LCD Contrast

Open to Answer

Any Key Answer



(System Setup)

Handset
(Base)Banner
DisplayKey Touch
ToneCall
Privacy

Banner Display (Handset only)

You can change the name your phone displays on the screen. If you have more than one handset, you can use the banner name to identify your handset during handset-to-handset functions like intercom and DirectLink. Go to **Banner Display** and enter the name you want to use. You can use up to 10 characters. Use the **DELETE** soft key to delete an existing handset name. Press **menu/select** when you're finished.

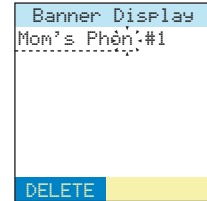

Key Touch Tone

Key Touch Tone is the tone your keypad makes when keys are pressed.

To turn off the tone, go to **Key Touch Tone** and select **Off**. A confirmation tone tells you that the tone has been deactivated.

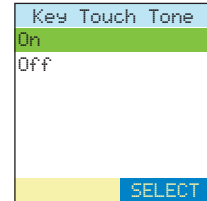

Call Privacy

If you don't want other registered handsets and the base to interrupt you on a call, you can turn on privacy mode. As long as your handset or the base is in privacy mode, other handsets won't be able to join your call or make any calls of their own. To turn on privacy mode, go to **Call Privacy** and select **On**. You can turn on privacy mode when the phone is in standby or when you're already on a call. You will hear a confirmation tone.

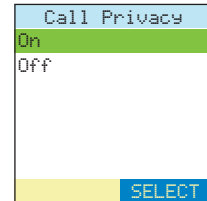

Language (For Base)

You can change the language the menu display will use. Choose from English, French, or Spanish. To change the language, go to **Language** and select **English**, **Français** (French), or **Español** (Spanish). You'll hear a confirmation tone, and the display will use the selected language.



Unique ID (Handset only)

You can assign special ringer tones to anyone in your phonebook. When your phone gets a call, it looks up the Caller ID information in your phonebook; if you've assigned a distinctive ringer and pictures to that number, the phone uses it so you know who's calling. To turn on distinctive ringing, go to **Unique ID** and select **On**. A confirmation tone tells you that distinctive ringing is active.

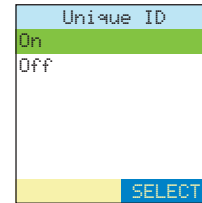

When viewing a Caller ID entry, the picture that corresponds to the Phonebook Unique ID setting appears. If the Unique ID is set to Off, the phone uses default picture for viewing Caller ID entries.

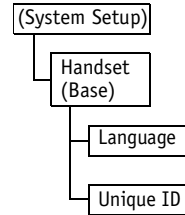



Some feature may not supported by older handset.



(System Setup)

Global

Date &
Time

Global Setup

Global settings apply to registered handsets and the base. If you change something under the global menu, you change it for all handsets and the base. Only one handset or the base can change global settings at a time, and you have to make sure the phone is not currently being used.



Date and Time

To change the date and time shown in the display, go to **Date & Time**. Use the up, down, right, left keys to highlight the part you want to change (date, time, AM/PM). Use the number keypad or ***/tone** to change each part. Press **menu/select** when you're finished.

Note: If you don't press any keys for two minutes when setting the date and time, the phone will exit the menu mode.

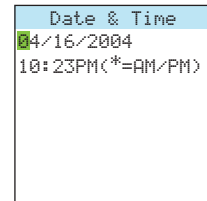

Call Waiting

Your phone supports Caller ID on Call Waiting, so you can see the name and number of someone who calls when you're already on the line. Your phone also supports Call Waiting Deluxe, which gives you a choice of how you want to handle a waiting call. You'll need to subscribe to these features with your phone company before you can use them.

To let your phone support these features, go to **Call Waiting**. Select **On**, and the phone will display the CallWaitDeluxe screen. Select **On**. (You have to turn on Call Waiting before you can turn on Call Waiting Deluxe.) A confirmation tone tells you that your phone is ready to use these features.



You can't turn off Call Waiting on your mobile line. To disable Call Waiting on your mobile phone, refer to the documentation provided with your mobile phone.

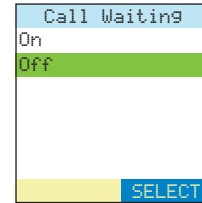

Area Code

If you can make a call by dialing only 7 digits (instead of 10), you can program your local area code in your phone. If you get a call from within your area code, you'll only see the 7-digit phone number. If you get a call from outside your area code, you'll see all 10 digits.

To enter an area code, go to **Area Code**. Use the number keypad to enter your 3-digit area code. Press **menu/select** when you're finished.

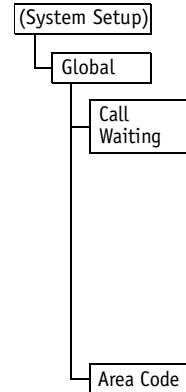
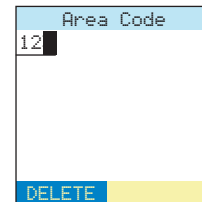



(System Setup)

Global

Dial Mode

(Ringer Options)
(Base:Rings/Volumes)

Ringer Tones

Dial Mode

Your phone can communicate with the telephone network in two different ways: tone dialing and pulse dialing. These days, most phone networks use a method called tone dialing, so your phone comes programmed for tone dialing.

If your phone company uses **Pulse** dialing, you'll need to change your phone's dial mode. There's an easy way to tell: try making a call. If your call connects, your phone's setting is fine. If not, go to **Dial Mode** and select **Pulse**. A confirmation tone tells you you've changed the dial mode, and you can try making a call again.

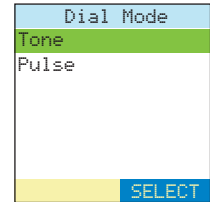

Setting the Ringer Options

This menu lets you customize the Ringer or Speaker Volume settings in your phone. You can set these options separately for each handset and the base.



Ringer Tone

You can set a different ringer for each handset and the base.

This phone comes with 10 prerecorded songs and 15 different ringer tones; for the handset you can also record your own ringer tones (see page 33).

- Songs: Beethoven's Symphony #9 [Beethoven9], For Elise [Elise], Home Sweet Home [Hm Swt Hm], Lorri Song #6 [Lorri Song], WT Overture (Handset only), Twinkle Star (Handset only), Je Te Veux (Handset only) When the Irish Eyes Are Smiling [Irish Eyes] (Base only), Aura Lee (Base only), Let Me Call You Sweet Heart [Sweetheart] (Base only), Star Spangled Banner [Star Spngl], Old MacDonald [Old MacDld], We Wish You A Merry Christmas [Merry-Xmas]
- Ringer tones: Flicker, Clatter, Coin Toss, Synthesize, Finish Line, Soft Alert, Wake Up, Lighting Bug, Bebop, Tone Board, Chirp, Party Clap, Reminder, Burble, TeleTone

- 1) Go to Ringer Tones.
- 2) Select the tel type, Land or Mobile.
- 3) Select a ringer from the list.

As you scroll through the list, each ringer will sound. You'll hear a confirmation tone, and the phone will go back to the menu.

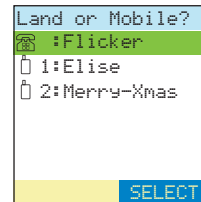



(Ringer Options)
(Base:Rings/Volumes)

Unique Ring

Vibrate All

Unique Ring (Base Only)

You can assign special ringer tones to anyone in your phonebook. When your phone gets a call, it looks up the Caller ID information in your phonebook; if you've assigned a distinctive ringer to that number, the phone uses it so you know who's calling.

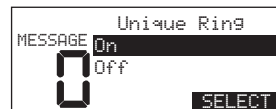

To turn on distinctive ringing, go to `Unique Ring` and select `On`. A confirmation tone tells you that Unique Ring is active.

Vibrate All (Handset Only)

The vibrate alert causes the handset to vibrate when an incoming call is received. For safety reasons, the handset will not vibrate while it is charging in base. To turn on the Vibrate Alert, go to `Vibrate All` and select `On`. A confirmation tone tells you that Vibrate Alert is active.

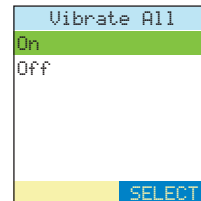

Call Vibrate (Handset Only)

You can choose one of four different vibrate patterns. To set Call Vibrate, go to **Call Vibrate** and select **Tel Type (LAND or MOBILE)**, and then select the pattern. Selecting **OFF** will turn off the vibrate feature for incoming calls only. A confirmation tone tells you that Vibrate Pattern is active.

Customize Your Own Distinctive Ringer Tones (Handset Only)

Your phone can store up to 5 different recordings to use as ringer tones (a total of 100 seconds). Each recording must be less than 20 seconds long.

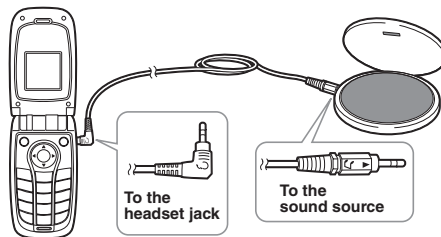

Storing Ringer Tones

- 1) Connect the audio recording cable to the handset and sound source (e.g. stereo or CD player). Insert one end of the audio recording cable into the handset's headset jack and the other end into the sound source. You can also simply use the handset's microphone by holding the handset close to the sound source.



(Ringer Options)

Call Vibrate

Rec/Edit
Rings

- 2) Go to `Rec/Edit Rings`.
- 3) Select a location from 1-5, and press the **OPTIONS** soft key.
- 4) Use the up/down key to select `Record`. To start recording, press the **RECORD** soft key. The message counter displays 20 and then begins to count down.
- 5) When you are finished recording, press the **STOP** soft key. The phone will play the recorded ringer. To re-record the ringer, press the **ReRec** soft key while playing the ringer.
- 6) Enter the title of this ringer (up to 12 digits) using the number keypad, or the **DELETE** soft key, right, or left key.
- 7) Press *menu/select*, you will hear a confirmation tone, and `Done!` appears.



Playing the Ringer

- 1) Go to `Rec/Edit Rings`.
- 2) Select a ringer to play, and press the **OPTIONS** soft key.
- 3) Use the up/down key to select `Play`. To stop, press *menu/select* or the **STOP** soft key.

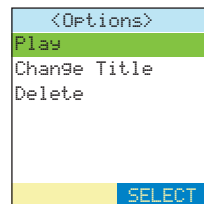

Change Ringer Name

- 1) Go to `Rec/Edit Rings`.
- 2) Select a ringer you want to change the title, and press the **OPTIONS** soft key.
- 3) Use the up/down key to select `Change Title`.
- 4) Edit the title of this ringer (up to 12 characters) using the number keypad, the **DELETE** soft key, right, or left key. When you are finished, press *menu/select*, you will hear a confirmation tone, and `Done!` appears.

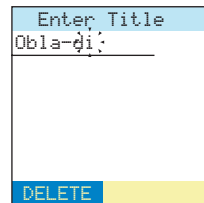

Deleting the Ringer

To delete a ringer tone, go to **Rec/Edit Rings**, and select the ringer you want to delete. Press **OPTIONS** soft key. Use the up/down key to select **Delete**. Select **Yes**. You will hear a confirmation tone, and **Deleted!** appears. The ringer is deleted from the list, and the phone stays on the ringer list.



You can not delete the ringer if it's currently being used for the default ringer tone, a Unique Ring setting, or a Reminder.

Display Settings (Handset Only)

The following submenu options must be set separately for each handset.

Wallpaper/Image Displays (Handset Only)

Your phone has 34 preset wallpaper/images to choose from. You can customize or replace 30 of these images using the software application CD-ROM supplied with this phone.

During standby mode the wallpaper will display on the handset's LCD Screen. To set your wallpaper, scroll through the Wall

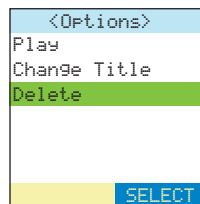

(DisplayOptions)

Wall Paper



(DisplayOptions)

Color Scheme

LCD Contrast

Paper options, and press the **VIEW** soft key. Press *menu/select* to activate the wallpaper of your choice.

Note: You can download images using the PC application CD-ROM and use them for your wallpaper.

Color Scheme (Handset Only)

You can change the color of your phone's display. There are 5 different colors to choose from: Sky Blue, Haze Gray, Chic Purple, Coral Red, and Lime Green.

To change the color of the display, go to **Color Scheme** and select the color you want. As you scroll through the options, the phone displays the highlighted color for you.



LCD Contrast (for the Handset)

LCD Contrast adjusts the handset's display. To adjust the contrast, go to **LCD Contrast** and use the up, down, right, or left key to adjust the contrast level you want. Press *menu/select* to activate it. You will hear a confirmation tone.



Animation Type (Handset only)

Your phone has 4 different system animations (Dog, Car, Frog and Abstract) with 7 different animation schemes:



delete



done



page



talk



batt-low



end



unavailable

To set your animation type, scroll through Animation Type options, and press the **VIEW** soft key. Press *menu/select* to activate the animation type of your choice.

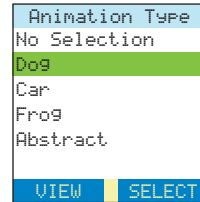

Language (for the Handset)

You can change the language the menu display will use. Choose from English, French, or Spanish. To change the language, go to Language and select English, Français (French), or Español (Spanish). You'll hear a confirmation tone, and the display will use the selected language.



(DisplayOptions)

Animation Type

Language



- If no Bluetooth phone with Bluetooth Device was found, Bluetooth Device was not found, appears.
- To cancel searching, press the **STOP** soft key.

Using the Bluetooth Feature

Registering a Mobile Phone to the Main Base Unit

Your phone can pair with Bluetooth v 1.1 compliant mobile phones so you can use your mobile line in addition to the usual land line. This lets you answer your mobile phone from any of your home phone handsets or use any free long distance minutes from your mobile plan on your home phone. You only have to pair your mobile phone to the base once. The base can support two paired Bluetooth devices.

 Only one mobile line can make or receive a call at a time.

The phone provides two different ways of pairing: Search Device and Find Me. Check your mobile phone's owner's manual to decide which method is best for your mobile.

a. Search Device

- 1) Activate the Bluetooth option on your mobile phone according to the owner's manual.
- 2) With the ELBT595 in standby mode (not in use), press **menu/select** on the base.
- 3) Use the up/down key to scroll through options and select **System Setup**.
- 4) Use the up/down key to scroll through **System Setup** and select **Bluetooth**.
- 5) Select **Select**  **Mobile**.
- 6) Select an empty slot and press the **OPTIONS** soft key.

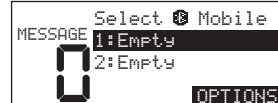

- 7) Select Search  Device. The phone will search for Bluetooth mobile phones and display the first six mobile phones found.

To cancel the search, press the stop soft key. If no device is found, Bluetooth Device was not found appears.

- 8) Use the up/down key to select a device to connect, and then press *menu/select*.
- 9) Scroll to the mobile phone you want to pair with the ELBT595, and press the **CONNECT** softkey.
- 10) Using the mobile phone, enter the PIN code "0000."

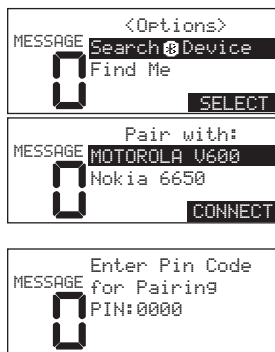

When pairing is completed, you will hear a confirmation tone, and Pairing successful! appears on the base. If pairing failed, Pairing failed. Try again appears.

b. Pair/Find Me



- 1) Follow the step 2) - 6) under "a. Search Device. " on page 38.
- 2) Select Find Me.
- 3) On your mobile phone, perform Search Device and select "Uniden ELBT 595."
- 4) On the mobile, enter the pin code "0000". Connecting appears on the base unit display.

When pairing is completed successfully, you will hear a confirmation tone, and Pairing successful! appears on the base. If pairing failed, Pairing failed. Try again. appears.



If you de-register the priority mobile phone, go to the Mobile Priority menu and select a different mobile phone (see page 24).

De-registering the Mobile Phone

- 1) When the phone is in standby mode, press **menu/select** on the base.
- 2) Select **System Setup** menu, and then **Bluetooth**.
- 3) Use the up/down key to select **Select Mobile**, and then press **menu/select**.
- 4) To delete individual Mobile phone, use the up/down key to select a Mobile phone to be de-registered and press the **OPTIONS** soft key.
- 5) Use the up/down key to select **Deregister** or **Deregister All** to de-register all, and then press **menu/select**.
- 6) Use the up/down key to select **Yes**, and then press **menu/select**.

When the de-registration is complete, you will hear a confirmation tone, and **Deregistration successful!** appears.

Editing the Mobile Name

You can store and edit names of registered Mobile phones.

- 1) When the phone is in standby mode, press **menu/select** on the base.
- 2) Select **System Setup** menu, and then select **Bluetooth**.
- 3) Use the up/down key to select **Select Mobile**, and then press **menu/select**.
- 4) Use the up/down key to select a Mobile phone to edit the name, and press the **OPTIONS** soft key.
- 5) Use the up/down key to select **Edit Name** and then press **menu/select**.
- 6) Enter or edit the name using the number keypad, the **DELETE** soft key, and right and left key.
- 7) When you are finished, press **menu/select**. You will hear a confirmation tone, and **Done!** appears.

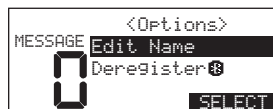



If you turn on the mobile ringer, the unique ringer feature will be disabled.

Setting the Mobile Ring Tone (Base Only)

This feature allows the phone to use the ringer of the mobile phone when receiving a call to the mobile phone.

- 1) When the phone is in standby mode, press **menu/select** on the base.
- 2) Select **System Setup** menu, and then  **Bluetooth**.
- 3) Use the up/down key to select **Mobile Ring Tone**, and then press **menu/select**.
- 4) Use the up/down key to select on or off, and then press **menu/select**.
- 5) Press the **YES** or **NO** soft key.

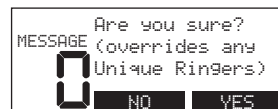

Viewing Bluetooth Properties of the Base

To see property of the base, follow the steps below:

- 1) When the phone is in standby mode, press **menu/select** on the base.
- 2) Select **System Setup** menu, and then  **Bluetooth**.
- 3) Use the up/down key to select **My Base Unit**, and then press **menu/select**.

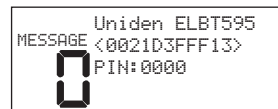

The phone displays the property of the base.

To go back to the Bluetooth setup Menu, press **back/hold/int'com**.

Auto Reconnect

If you set this feature to on, the phone will search for the paired mobiles once every minute.

- 1) When the phone is in standby mode, press **menu/select** on the base.
- 2) Select System Setup menu, and then Bluetooth.
- 3) Use the up/down key to select Auto Reconnect *, and then press **menu/select**.
- 4) Use the up/down key to select On or Off, and then press **menu/select**.



Reconnect Mobile

This feature allows the phone to reconnect to a paired mobile.

- 1) When the phone is in standby mode, press **menu/select** on the base.
- 2) Select Reconnect *, and then press **menu/select**.
Connecting will appear.
When the connection is complete, * appears next to the name of the device connected.

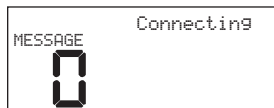
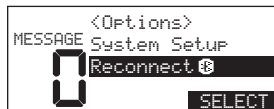



- Even if the headset ringer is turned off or if DND mode is turned on, a paired Bluetooth headset will still ring.
- The Bluetooth headsets must stay within 15 feet (5m) range of the cordless handset.
- If no device is detected, Bluetooth Device was not found. appears, and the phone goes back to the Bluetooth setup menu.

Using Bluetooth Headset (Handset Only)

The phone also supports Bluetooth v 1.1 compliant headsets. Please visit our web site for more detailed information about Bluetooth compatibility and troubleshooting tips.

Before you can use a bluetooth headset, you must pair it with the phone. Once you have paired your headset with the phone, you do not have to pair it again until you want to use it with another phone.

Registering the bluetooth headset

- 1) Prepare your bluetooth headset for pairing according to the headset's owner's manual on pairing.
- 2) With the phone in standby mode (not in use), press *menu/select* on the handset.
- 3) Select the Bluetooth icon on the handset's main menu display.
- 4) Use the up/down key to select Find/Pair , and then press *menu/select*.

The ELBT595 will begin to search for a bluetooth device. Once detected, the headset's name will appear in the handset's display.

Press the **STOP** soft key to back to show the list of the bluetooth headsets.



- 5) Scroll to a headset you want to pair with the ELBT595 handset, and press the **SELECT** soft key.
- 6) Using the cordless handset, enter your headset's PIN code.
- 7) Press the **CONNECT** soft key.

When pairing is completed, you will hear a confirmation tone, and `Pairing successful!` appears on the handset. If pairing failed, `Pairing failed. Try again.` appears.

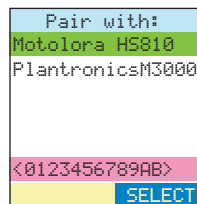

Viewing Paired Headsets

To review headsets paired to this cordless handset, follow the steps below:

- 1) When the phone is in standby mode, press *menu/select* on the handset.
- 2) Select the Bluetooth icon.
- 3) Use the up/down key to select  Headset, and then press *menu/select*.

The headset name and serial number are displayed.

To go back to the Bluetooth setting display, press *back/hold/int'com*.

Viewing Bluetooth Properties of the Handset

To view the handset information, follow the following steps:

- 1) When the phone is in standby mode, press **menu/select** on the handset.
- 2) Select the Bluetooth icon.
- 3) Use the up/down key to select **My Handset**, and then press **menu/select**. The handset name and serial number are displayed.

To go back to the Bluetooth setting display, press **back/hold/int'com**.

Turning Bluetooth ON or OFF

The Bluetooth connection still uses power even when you're not currently using a Bluetooth device. To save power, you can turn off the Bluetooth connection when it's not in use.

- 1) When the phone is in standby mode, press **menu/select** on the handset.
- 2) Select the Bluetooth icon.
- 3) Use the up/down key to select **On/Off**, and then press **menu/select**.
- 4) Use the up/down key to select **On** or **Off**, and then press **menu/select**.



To go back to the Bluetooth setting display, press **back/hold/int'com**.

To reconnect the Bluetooth Headset

If a paired headset will not connect to the handset, you can reconnect to the headset.

- 1) When the phone is in standby mode, press **menu/select** on the handset.
- 2) Select the Bluetooth icon.
- 3) Use the up/down key to select **Headset**, and then press **menu/select**.
- 4) Press the **OPTIONS** soft key and select **Reconnect**.
- 5) Use the up/down key to select **Yes**, and then press **menu/select**.

You will hear a confirmation tone, and **Done!** appears.

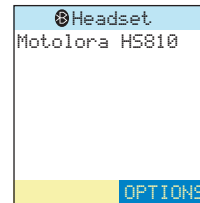

De-register the Bluetooth Headset

If you want to stop using a paired headset completely, you can deregister it; this will allow you to pair another headset in the future. You can also try deregistering and re-pairing a headset if you can't connect to it.

- 1) When the phone is in standby mode, press **menu/select** on the handset.
- 2) Select the Bluetooth icon.
- 3) Use the up/down key to select **Headset**, and then press **menu/select**.
- 4) Press the **OPTIONS** soft key and select **Deregister**.
- 5) Use the up/down key to select **Yes**, and then press **menu/select**.

You will hear a confirmation tone, and **Deregistration successful!** appears.

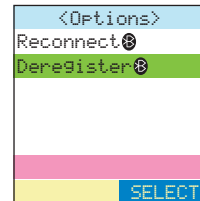



- Before using a mobile line, you need to register the mobile phone to the base (see page 38).
- When you dial a number with the handset in standby mode, hyphens are inserted between numbers.
- If the line is already in use, all other registered handsets and the base display "In Use."

Using Your Phone

If you have a Bluetooth v1.1 compliant mobile phone and register it to the base, you can make or receive a call through the mobile line as well as the normal land line. To use the mobile line, press the **MOBILE** soft key. The two lines will be completely independent on your phone. For example, you can have one handset talking on **LAND** line while another handset and the base unit participate in a 3-way conference on the mobile line.



- You can not make or receive a land line call using a Bluetooth mobile phone.
- A Bluetooth mobile phone will not ring when the ELBT595 receives a land line call.

Making Calls Using the Land Line From the Handset

- 1) Remove the handset from the charging cradle.
- 2) Flip the top panel up.
- 3) Press **talk/flash** or the **LAND** soft key.

For mobile line connection, press the **MOBILE** soft key. Use the up/down key to select the Mobile phone you want to use and press the **CONNECT** soft key.

- 4) Dial the number.

OR

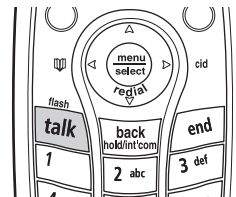

- 1) Remove the handset from the charging cradle.
- 2) Flip the top panel up.
- 3) Dial the number.

If you need the phone to pause before dialing more digits (for example, to enter an access code or extension), press **menu/select**, and select **Pause Entry** from the list. **P** appears in the display.

- 4) Press **talk/flash** or the **LAND** soft key for Land line.

For Mobile line connection, press the **MOBILE** soft key. Use the up/down key to select the Mobile phone you want to use and press the **CONNECT** soft key.

From the Handset Speakerphone

- 1) Remove the handset from the charging cradle.
- 2) Flip the top panel up.
- 3) Press **▷** (Speaker Phone) on the side of the handset.
- 4) Listen for the dial tone.
- 5) Dial the number.
- 6) When the other party answers, talk into the microphone in the bottom of the handset.

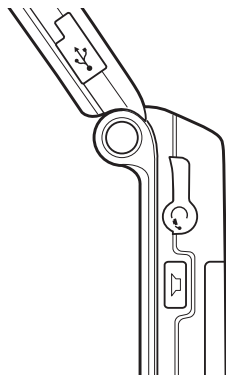

- In the list for mobile line, select the mobile marked with *. A mobile without * beside it is out of range.
- When making a call using the mobile line, you must dial the number in 10 seconds, or the phone return to standby mode.
- For best performance, use the speaker phone in a quiet room and let the caller finish speaking before you speak. If you or the other party has difficulty hearing, adjust the speaker volume.



- If Open to Answer is on, the phone will automatically answer the call when you flip the top panel up (see page 25 for setting).
- If Any Key Answer is on, you can also press any number key on the keypad to answer a call (see page 25 for setting).
- If you set mobile priority on the base or a handset, it will automatically connect to the priority mobile when you press the **MOBILE** soft key.
- Make sure the Auto Answer feature on your Bluetooth mobile phone is turned off. If AutoAnswer is on, your mobile may answer the call and interrupt your ELBT595. If this happens, the ELBT595 will place the call on hold.

From the base

- 1) Press **Ⓜ**/**flash** or the **LAND** soft key.
For Mobile line connection, press the **MOBILE** soft key. Use the up/down key to select the Mobile phone you want to use and press the **CONNECT** soft key.
- 2) Dial the number.

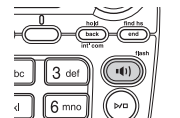

OR

- 1) Dial the number.
If you need the phone to pause before dialing more digits (for example, to enter an access code or extension), press **menu/select**, and select **Pause Entry** from the list. **P** appears in the display, which represents a 2-second pause.
- 2) Press **Ⓜ**/**flash**. For Mobile line connection, press the **MOBILE** soft key. Use the up/down key to select the Mobile phone you want to use and press the **CONNECT** soft key.

Receiving a call/AutoTalk set to Off

Handset is in the cradle	Handset is off the cradle
<ol style="list-style-type: none">1) Remove the handset from the charging cradle.2) Flip the top panel up.3) Press talk/flash or the corresponding soft key (LAND or MOBILE).	<ol style="list-style-type: none">1) Flip the top panel up.2) Press talk/flash or the corresponding soft key (LAND or MOBILE).

From the base

Press **Ⓜ**/*flash* or the corresponding soft key (**LAND** or **MOBILE**).

Hanging Up

From the handset or handset speakerphone, press **end** or close the top panel.

From the base, **end/find hs**.

Switching to the Handset Speakerphone During a Call

To switch a normal call to the speakerphone, press **▷** (speaker phone) on the side of the handset. To switch from a speakerphone call to a normal call, press **▷** (speaker phone).

Moving out of range

If you move your handset farther from the base unit during a call, you might start to hear more noise than usual. If you go too far from the base, you'll hear a beep and see **No Signal Press HELP**. Press the **HELP** soft key on the display.



- While using the handset speaker phone or a headset, closing the top panel will not hang up the call.
- To scroll through the help, press the **>>|** soft key or the right key.



- You must subscribe through your local telephone company to receive Call Waiting or Caller ID on call waiting service.
- Your phone can't show call waiting caller ID information when a call is on hold.

Call Waiting

If you hear a call waiting tone while you're on a call, press **talk/flash** or ***||/flash** on the base to switch to the new call. After a short pause, you'll hear the new caller. Press **talk/flash** or ***||/flash** on the base again to go back to the original caller.

Call Waiting Deluxe

If you subscribe to Call Waiting Deluxe (CWDX) from your phone company, you have several different options when you get a call waiting call. When you hear the call waiting tone, instead of answering the call, you can press **menu/select** or the **OPTIONS** soft key, and then select **CallWaitDeluxe**. Then, use the up/down key or press 1-7 (1-4 for Mobile line) to choose from the following options:

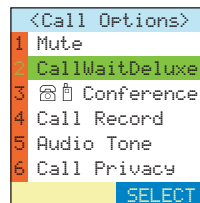

Option	Definition	On a LAND line, press	On a MOBILE line, press
Ask to Hold	A prerecorded message tells the caller that you'll be available shortly, and the call is place on hold.	1	-
Tell Busy	A prerecorded message tells the caller you are busy, and the waiting call is disconnected.	2	1
Forward	The caller is sent to your voice mail box, if available.	3	-
Answer/Drop 1	Disconnects the first call, and connects to the new caller.	4	2
Conference	Starts a conference call with your first and second callers.	5	4
Drop First/Drop Last	During a conference call, allows you to choose to drop the first or last caller.	6 / 7	-
Answer/Hold 1	Releases all active calls (if any exist) and accepts the other (held or waiting) call	-	3

Placing a Call on Hold

From the handset

During a call, press **back/hold/int'com**, and then **end** to put the call on hold. Press **talk/flash** to go back to the call.

From the base

During a call, press **back/hold/int'com**, and then **end/find hs** to put the call on hold. Press **talk/flash** to go back to the call.

Conferencing

If you have two handsets and the MOBILE line, up to five people can participate in a conference call. A five-way conference call consists of

Outside Line (LAND) + Outside Line (MOBILE) + Base + Two Handsets.

Only two handsets can participate in any conference call.

Joining a Conference Call

You can easily join a call already in progress.

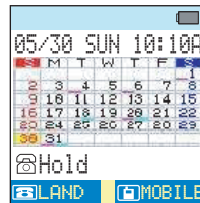

- If you leave a call on hold for more than 5 minutes, warning tone sounds and Hold Reminder! Answer held line appears, and the line will disconnect in 15 seconds.
- If someone is using another handset or the base in Privacy Mode, Unavailable appears in the display and you cannot join the call.



During a line conference with LAND/MOBILE, mobile transfer, flash, dialing, CWDX, phonebook/caller ID/redial operations are not available.

From the base

- 1) Press corresponding soft key (LAND or MOBILE) on the base to join the conference call.
- 2) To hang up, press **end/find hs** on the base. The handset(s) will still be connected to the call.

From a second handset

- 1) Press corresponding soft key (LAND or MOBILE) on the handset to join the call.
- 2) To hang up, return the handset to the cradle, or press **end** on the handset. The base or other handset will still be connected to the call.

Conferencing with one outside line

To hold a conference call with one outside line, simply have the handsets or base join the call.

Conferencing two outside lines (LAND / MOBILE)

Follow the steps below to allow both outside lines to participate in a conference call:

- 1) During a call, press **back/hold/int'com**, and then **end** or **end/find hs** on the base to put the first caller on hold.
- 2) Press the line soft key (LAND or MOBILE) for a free line to make or answer a second call.
- 3) When the second call is connected, press **menu/select** and select  Conference to initiate a conference call.
- 4) To disconnect a single caller, press the corresponding soft key (LAND or MOBILE) to place the caller you wish to keep speaking to on hold and then press **end** or **end/find hs** to hang up the other caller.

For example, to hang up the MOBILE line but leave the LAND line connected:

- Press the **MOBILE** soft key to put the **LAND** line on hold.
- Press *end* or *end/find hs* to hang up the **MOBILE** line.
- Press the **LAND** soft key to take the **LAND** line off hold and continue the conversation.

To hang up both lines, press *end* or *end/find hs* with the two line connected.

Mobile Line Transfer

The phone allows you to transfer a mobile line call to your mobile phone, or receive a mobile line call from your mobile phone.

From your mobile phone to ELBT595 phone

Press the **MOBILE** soft key on the ELBT595 phone during a call with your mobile handset, and then the **CONNECT** soft key.

From the ELBT595 phone to your mobile phone

Press *menu/select* during a mobile line call, and select `Transfer>Mobile`.
Transferred appears and the ELBT595 phone return to standby mode.



You can reject a call to a mobile line by pressing **∅** key when the phone is ringing.



- Each redial record can store up to 32 digits.
- To store redial numbers in the Phonebook, see page 66.

Redialing Calls

You can quickly redial the last 20 phone numbers for each handset and 10 numbers for the base.

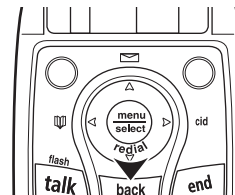

- 1) With the phone in standby mode, press **redial**/ ∇ on the handset (or press **menu/select**, and then select **Redial** on the base). This brings up the redial list. Use the up/down key to scroll through the numbers, and select the number you want to dial.
- 2) Press the **LAND** soft key, **talk/flash** (or \triangleright) or the **CALL** soft key or \bullet /**flash** on the base to dial the selected number. If you want to call using the mobile line, press the **CALL** soft key, then **MOBILE** soft key. Use the up/down key to select the Mobile phone to use and press **CONNECT** soft key.

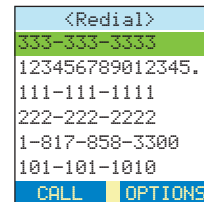

You can also display the redial list for redial number with the phone in talk mode. After selecting the redial number, press the **DIAL** soft key to redial the number.

Deleting Redial Records

If you want to delete a phone number from the redial list, go to the redial list in standby mode, and select the number you want to delete. Press the **OPTIONS** soft key, and select **Delete Selection**. Use the up/down key to move the cursor to **Yes**. Press **menu/select**. If you want to delete all the redial records, select **Delete All**, and then **Yes**. Press **menu/select**.

Adjusting Base Ringer and Speaker Volumes

Adjusting the base ringer volume

You can choose from three ringer settings on the base: off, low, and high. When the phone is in standby mode, go to the Rings/Volumes menu, and then select Ringer Volume. Use the up or down key to select the Tel type (LAND or MOBILE), and press **menu/select**. Use the up, down, right, or left key to select the ringer volume, and press **menu/select**. You will hear a confirmation tone.

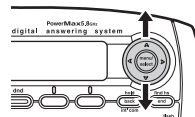

Adjusting the base speaker volume

You can adjust the volume of the answering machine speaker while a message is playing. Press the **volume** up/down key during a message to choose one of the 10 volume levels.

You can also set the speaker volume from the menu. Go to Rings/Volumes menu, and then select Speaker Volume. Use the up, down, right, or left key to select the speaker volume, and then press the **menu/select**. You will hear a confirmation tone.

Using the Handset Volume Setting Menu

Ringer: Adjust the handset ringer volume

You can choose from three different ringer volume settings on your handset: off, low, and high. When the phone is in standby mode, go to the Ringer Options menu, and then select Ringer Volume. Use the up, down, right, or left key to select the Tel type (LAND or MOBILE), and press **menu/select**. Use the up/down key to select the ringer volume, and press the **menu/select**. You will hear a confirmation tone.

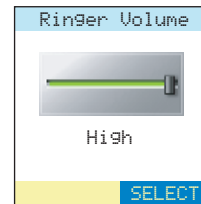

Ear speaker: Adjust the handset earpiece volume.

You can choose from six volume levels for the earpiece speaker. To adjust the earpiece volume, go to Speaker Setup menu, and select Earpiece Volume and select the volume level you want to use.

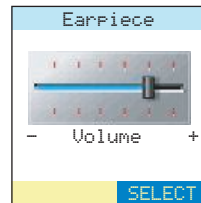

You can also adjust the earpiece volume during a call by pressing the Δ or ∇ key on the side of the handset, and then up (to make it louder) or down (to make it softer).

Speaker: Adjust the handset speaker volume

You can choose from six volume levels for the handset speakerphone. To adjust the speaker volume, go to Speaker Setup menu, and select **Speaker Volume** select the volume level you want to use.

You can also adjust the handset speaker volume during a call by pressing the ∇ or Δ key on the side of the handset, and then up (to make it louder) or down (to make it softer).

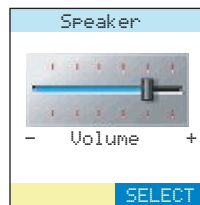

Audio Tone

If you aren't satisfied with the audio quality of your phone, you can adjust the Audio Tone of the earpiece. Your phone gives you three audio tone options: low, natural or high. Go to Speaker Setup menu, and select **Audio Tone** and select the option that sounds best to you. (Audio tone adjustments only apply to the earpiece, not the speakerphone.)

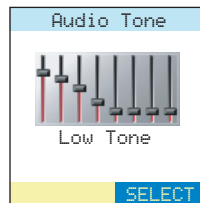

Mute

While the handset is ringing, you can mute the handset ringer for this call by pressing **end** on the handset. To mute the base ringer, press \triangleright or **end/find hs** on the base. The phone will ring again on the next call.

Mute the Microphone

When you're on the phone, press **menu/select** and select **Mute** to turn off the microphone so the caller can't hear you. The display shows **Mute On** while the microphone is muted. To turn off muting, repeat the above step again.

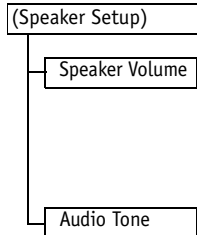

You can only mute the handset ringer if the handset is off the base when the phone starts ringing.

Tone Dialing Switch Over

If your telephone company uses pulse dialing, you can switch over to tone dialing after the call connects. This feature is useful when you need tone dialing to use any automated menu systems, such as telephone bank tellers, telephone prescription refills, customer support menus, etc.

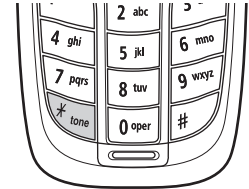

If your phone is set to pulse dialing mode, make your call normally. Once your call connects, press the ***/tone** key. Any digits you enter from then on will be sent as tone digits. When this particular call ends, the phone automatically returns to pulse dialing mode.

Privacy Mode

Privacy mode prevents interruption from other registered handsets or the base. This works only when the phone is in use. While on a call, press the **OPTIONS** soft key on the handset or base. Use the up/down key to select Call Privacy. Privacy Mode On appears in the display. To exit Privacy Mode, use the same procedure. Privacy Mode Off appears.

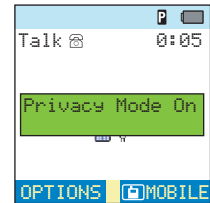

Find Handset

To locate the handset, press **end/find hs** on the base when the phone is in standby mode. Select the handset to page. The handset beep for 60 seconds, and **Paging** appears on the handset display. To cancel paging, press any key on the handset or **end/find hs** on the base.

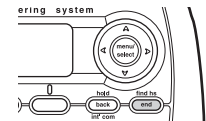

Reminder (Handset only)



The Date & Time must be set to use the Calendar features. To set the Date & Time, scroll to Global in the System Setup option (see page 24).

Your phone has a built-in calendar that you can use to schedule reminders and appointments (all the way through December 31, 2099). You can set alarms for up to 30 different events.

A pop-up screen appears and reminder tone sounds when the scheduled time & date comes. To show detailed info on the reminder, press the **VIEW** soft key. To mute the reminder tone, press the **MUTE** key.

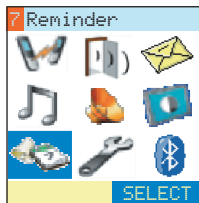

To reset the reminder and clear the screen, press **end** when reminder tone stops. To dismiss Reminder display press **DISMISS** appears. Press the **DISMISS** soft key. The phone return to standby mode.

Scheduling a reminder

Select the Reminder option to show Reminder (Calendar). Today is highlighted. If the reminder is set for the morning, a bar appears in the lower left of the date number; if the reminder is set for the afternoon or evening, a bar appears in the lower right of the date number. Use up, down, right or left key to move the cursor to the date.

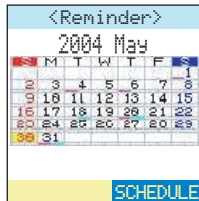

Before using this feature, you must set the date and time (see page 24).

- 1) Press **menu/select** to select a day.
- 2) Press the **STORE** soft key to add a reminder.
- 3) Press **menu/select** to set the date and time.
- 4) Use the number keypad or ***/tone** to select the hours and minutes. Press **menu/select** when you're finished.
- 5) To change the title, select **!** and press **menu/select**. Use the number keypad, left, right key, and the **DELETE** soft key. Press **menu/select** when you're finished.
- 6) If you want to set recurrence, select **Q**, and press **menu/select**. Select the frequency of the recurrence (None, Daily, Weekly, Monthly, Yearly) from the list. Press **menu/select** when you're finished.
- 7) If you want your phone to ring when this reminder occurs, move to the line **J**, and press **menu/select**. Select the ringer tone you want the phone to ring. Press **menu/select** when you're finished.
- 8) To enter a description for this reminder, select **Message** and press **menu/select**. Edit **Message** appears. You can enter up to 80 characters. Press **menu/select** when you're finished.
- 9) When everything is correct, press the **DONE** soft key.



Editing and deleting reminders

You can edit reminders by pressing the **SCHEDULE** soft key, then select the reminder and press the **OPTIONS** key. Select **Edit Selection**, and you can edit the date, time, reminder tone, and text the same way you entered them for a new entry.

To delete reminders, select the reminder and press the **OPTIONS** soft key. Select **Delete Selection**. To delete all reminders, select **Delete All**.

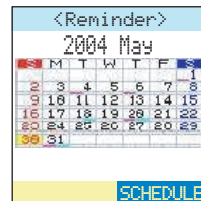

Using the Phonebook

Your phone lets you store up to 100 entries in each handset and base. You can store up to 4 phone numbers for each name in your phonebook (for a total of 400 numbers), and you can assign names to groups for easy searching. You can store a distinctive ringer tone and picture display, to your each or group.

You can enter your phonebook by pressing the left key on the handset or base.

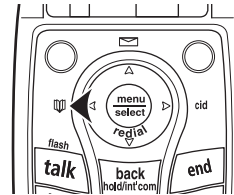



Creating and Editing Phonebook Entries

Press left key and press the **STORE** soft key for the first entry. From the 2nd entry on, press the left key, and then the **OPTIONS** soft key. Select *New Entry* to store, or *Edit Selection* to edit the location. Enter as much of the following information as you want. Press **menu/select** to enter each entry and confirm the selection. When you're finished, press the **DONE** soft key to save this phonebook entry.





You can save up to 4 numbers for each phonebook entry. You'll have to delete one of the existing numbers before you add a new one.

Step 1: Name ,

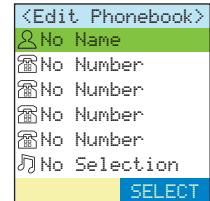





Select ,  and use the keypad to enter the name for this entry. You can enter up to 16 characters. If you don't want to enter a name, your phone will store this entry as No Name. Press **menu/select** when you're finished, and your phone will go back to the current phonebook entry.





Step 2: Number ,

Select ,  and enter a phone number for this entry. If you need your phone to pause between digits when it's dialing (for example, to enter an extension or an access code), press the **PAUSE** soft key to insert a two-second pause. You'll see a P in the display. You can stack more than one pause together if two seconds isn't long enough. Each pause counts as one digit; you can enter up to 20 digits for the phone number. Press **menu/select** when you're finished.



You can select an icon to remind you which number this is: home , , work , , mobile , , or general phone number . Press **menu/select** when you're finished.

Step 3: Unique Ring ,



Select ,  to attach a special ring to this phone. Select the ringer tone you want the phone to use when this person calls, or select No Selection to have the phone use its regular ringer tone. Press **menu/select** when you're finished, and your phone will go back to the current phonebook entry.

Step 4: Unique Display (Handset only)

Select  to attach a special screen display to this entry. Select the display you want the phone to use when this person calls, or select *No Selection* to have the phone use its regular display. You can press the **VIEW** soft key to see the display choices:

Press **menu/select** when you're finished, and your phone will go back to the current phonebook entry.

Step 5: Group ,

Select ,  to place this entry into a phonebook group. Select the group (0-9) you want this entry to belong to, or select *No Selection* to leave the entry outside of any group. Press **menu/select** when you're finished, and your phone will go back to the current phonebook entry. See page 69 for information on creating and editing groups.

Step 6: Speed Dial ,

Select **0-9** to save this number to one of the 10 speed dial numbers or *No Selection* if you don't want to save it to a speed dial number. If there's already a phone number saved to the speed dial number you select, your phone will ask if you want to overwrite the number. Press **menu/select** when you're finished, and your phone will go back to the current phonebook entry.

Storing Caller ID or Redial Numbers in the Phonebook

You can store Caller ID or redial numbers in your phonebook so you can use them later. Go to the Caller ID list or redial list and select the number you want to store. (If the Caller ID information didn't include the number, then you can't store it.)

- 1) With the phone in standby mode, go to the Caller ID list or redial list and select the number you want to store.
- 2) Press the **OPTIONS** soft key, and then select `Add to Phonebook`.
- 3) Use the up/down key to select `New Entry` to enter a new phonebook location. If you want to add a number to the existing phonebook location, select `Store & Edit`, and then select a location to edit.
- 4) Enter each entry and confirm the selection by following the steps in pages 64-65.

Storing and Editing Numbers from the Dial Operation

- 1) With the phone in standby mode, enter the number to store using the number keypad.
- 2) Press the **OPTION** soft key and select `Add to Phonebook`.
- 3) Use the up/down key to select `New Entry` to enter a new phonebook location. If you want to add a number to the existing phonebook location, select `Store & Edit`, and then select a location to edit.
- 4) Enter each entry and confirm the selection by following the steps in pages 64-65.

Managing the Phonebook

With the **OPTIONS** soft key, you can delete phonebook entries, copy entries to another handset, check how many empty phonebook and speed dial entries you have available, sort your phonebook by groups, and name phonebook groups.

Deleting phonebook entries

Go to the phonebook and select the entry you want to delete. Press the **OPTIONS** soft key and select `Delete Selection`. Your phone will ask you to confirm select `Yes`.

To delete all the entries from your phonebook, go to the phonebook and press the **OPTIONS** soft key without selecting an entry. Select `Delete All`. Your phone will ask you to confirm select `Yes`.

Copying phonebook entries to another handset or base

Note: When you copy entries to another handset or base, the group, speed dial, and icon information won't be transferred. Your phone will cancel the copying process if any one of the following things occurs:

- If the handset you are copying to doesn't have enough memory (the phone will show `Not enough memory in receiving unit`).
- If the handset you are copying to already has that phone number in its phonebook.
- A call comes in during the copying process.

To copy a single entry, go to the Phonebook and select the entry you want to copy. Press the **OPTIONS** soft key and then select **COPY Selection**. Select the handset or base you want to copy to the entry to.

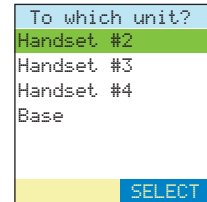

To copy all the phonebook entries, go to the phonebook and press the **OPTIONS** soft key without selecting an entry. Select then **COPY All**. Select the handset or base you want to copy to the entry to. Your phone will ask you to confirm select **Yes**.

Checking the number of stored entries

To see how many phonebook entries you have, go to the phonebook and press the **OPTIONS** soft key and select **PhoneBk Capacity**. The phone will show you how many stored names (entries) and how many stored phone numbers (total) you have.

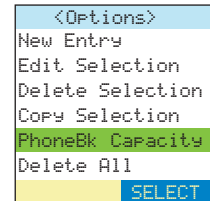

To see your speed dial entries, go to the phonebook and press the **OPTIONS** key and select **Check Ⓜ Dial**. The phone will show you which speed dial numbers have phone numbers stored in them.

Changing the sorting order

To change the sorting of your phonebook, go to the phonebook and press the **OPTIONS** soft key and select **Sort**. Select **Alphabetically** by pressing **menu/select** to see the list of names in alphabetical order; select **Group** by pressing **menu/select** to see the list of groups in alphabetical order. For alphabetical order, enter a letter from the keypad to jump to the first entry beginning with that letter.

Naming phonebook groups

Your phone comes with 10 groups to organize your phonebook. You can name groups things like "Family" or "Friends" or "Softball team" to let you find entries in your phonebook more quickly.

Follow the steps below to name a group:

- 1) Go to the Phonebook and select the **OPTIONS** soft key.
- 2) Scroll down to `Edit Group Name` and press *menu/select*.
- 3) Scroll down to the group number you want to edit, and press *menu/select*.
- 4) Use the number keypad to enter a name for this group. Press *menu/select* when finished.

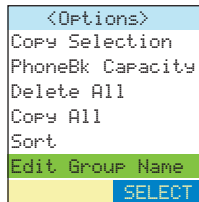

Making Calls with the Phonebook

To call someone in your phonebook, go to the phonebook and select that person's phonebook entry, and then press *menu/select*. Select the number (one of the four available) that you want to call, and then press *talk/flash* or \triangleright or \blacksquare /*flash* on the base. Press the **LAND** or **MOBILE** soft key. You can also dial the number with the phone in talk mode. After select number, press the **DIAL** soft key. The number at the top of the list will dial.

Using the Speed Dial

With the phone in standby mode, press and hold the number of the speed dial entry you want to call until the phonebook entry appears. Select the number (one of the four available) that you want to call, and then press the **LAND** or **MOBILE** soft key, or *talk/flash* and \triangleright or \blacksquare /*flash* on the base.



To make a speed dial using the mobile line, press the **MOBILE** soft key.



Some paired mobile phones may not support Caller ID information over a Bluetooth connection.

Caller ID Features

If you subscribe to Caller ID from your phone company, your phone will show you the caller's phone number and name (if available) whenever a call comes in.

If you subscribe to both Call Waiting and Caller ID the phone also shows you the name and the number of call waiting calls (that is, calls that come in while you're on the line.)

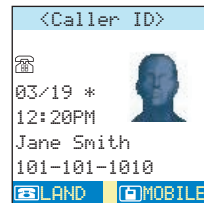

Using the Caller ID List

You can store up to 100 Caller ID numbers in each handset or the base. To see the Caller ID list, press the right key on the handset or base. The phone will show the Caller ID list. You can use the up/down key to scroll through the list, or you enter a letter with the keypad to jump to the first caller ID name that starts with that letter.

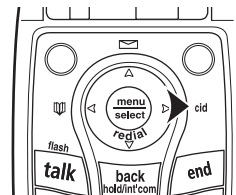

If you want to see how many Caller ID numbers are stored in your phone, Press the right key, and then the **OPTIONS** soft key. Select `CID Capacity`.

Calling someone from the Caller ID list

Go to the Caller ID list and select the number you want to call. If you need to add a "1" to the number for a long distance call, press ***/tone**. If you need to add your saved area code to the number, press **#**. Then press the **LAND** or **MOBILE** soft key or **talk/flash** or **⏏**, on the handset, or **⏏/flash** on the base.

Deleting Caller ID numbers

To delete only one Caller ID number, go to the Caller ID list and select the number you want to delete. Press the **OPTIONS** soft key, and select `Delete Selection`. When the phone asks you to confirm, select `Yes`.

To delete all the Caller ID numbers, go to the Caller ID list and press the **OPTIONS** soft key. Select `Delete All`. When the phone asks you to confirm, select `Yes`.

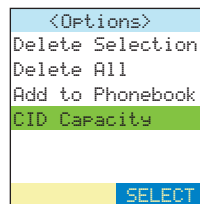

When you delete a Caller ID number, you delete it permanently.

Answering Machine

The phone has a built-in answering machine that answers and records incoming calls. You can also use your answering machine to record a conversation, leave a voice memo message, or announce a special outgoing message to callers when you're away from your phone.

Features

- Digital Tapeless Recording
- Up to 12-15 minutes of Recording Time
- Call Screening
- Personal or prerecorded Outgoing Messages
- Voice Prompts (English, Spanish, or French)
- Time and Day Announcement
- Remote Message Retrieval
- Toll Saver
- Conversation Recording
- Voice Memo
- Message Alert
- Retrieve Messages using Handset
- Do Not Disturb
- Hands-free Speakerphone

Setting Up the Answering Machine

To access the answering machine settings, go to the System Setup Menu and select Answer Machine.

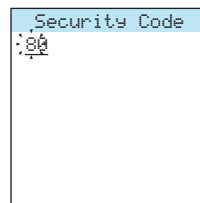
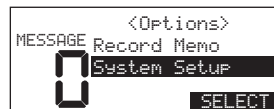

Security Code

If you want to call in and get your messages when you're away from, you'll have to set a security code. Go to Answer Machine and select Security Code. Use the keypad to enter a two-digit number (01-99), and press **menu/select** when you're done. A confirmation tone tells you the security code has been saved.



(System Setup)

Answer Machine

Security Code



(System Setup)

Answer
Machine

Ring Time

Record Time

Ring Time

You can set the number of times the phone will ring before the machine answers the call. Go to **Answer Machine** and select **Ring Time**. Then select the number of times you want the phone to ring; choose from 2, 4, or 6 times. The **Toll Saver** feature makes the answering machine answer after two rings if you have new messages and after four rings if you don't. If you call long distance to check your messages, **Toll Saver** lets you hang up after three rings and not get charged for the call.

Ring Time	
Toll Saver	
2 Times	
4 Times	
6 times	
	SELECT

Record Time

You can set how long a caller has to leave a message before the answering machine hangs up. Go to **Answer Machine** and select **Record Time**. Then select the maximum length of messages; choose from 1 minute or 4 minutes. The **Announce Only** feature makes the answering machine answer call but it won't let callers leave a message. When the **Announce Only** feature is on, and **Announce ONLY** will appear on the base.

Record Time	
1 Minute	
4 Minutes	
Announce Only	
	SELECT

Message Alert

If you want the answering machine to beep every 15 seconds whenever you have unheard messages, turn on the message alert tone. Go to **Answer Machine** and select **Message Alert**. Select **On**. A confirmation tone tells you the setting has been saved.

The message alert turns off automatically after you listen to all your new messages. You can also turn off the message alert by pressing any key on the base.

Language

To change the language of your answering machine's voice prompts and pre-recorded greetings, go to **Answer Machine** and select **Language**. Select **English**, **Français (French)**, or **Español (Spanish)**.

Call Screen

If you want to be able to listen to the caller's message before you answer, turn on the call screen feature. Go to **Answer Machine** and select **Call Screen**. Select **On** to turn on call screening.

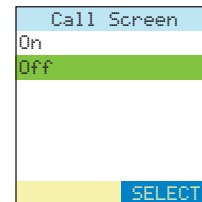
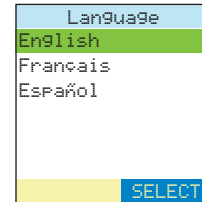
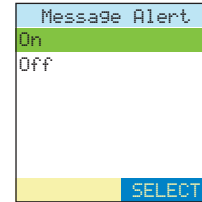

(System Setup)

Answering Machine

Message Alert

Language

Call Screen



(System Setup)

Answering
Machine

Record
Greeting

Greeting
Options

Setting Your Outgoing Greeting



Your answering machine comes with a prerecorded greeting: "Hello. No one is available to take your call. Please leave a message after the tone." You can use this greeting, or you can record your own.

 Your greeting must be more than 2 seconds and less than 30 seconds.

Recording a greeting From the base

To record your own greeting, make sure the phone is in standby mode. Go to **Record Greeting**, and then press **menu/select**. Press the **START** soft key. After the answering machine says, "Record greeting," you can start recording. The message counter displays 30 and then begins to count down. When you're finished, press the **STOP** soft key. The answering machine will play back your greeting so you can hear it.

From the handset

Press . Press  hi!/8. After the answering machine says, "Record greeting," you can start recording. When you're finished, press  hi!/8 key.

Choosing a greeting From the base

To choose between the two greetings, first make sure the phone is in standby mode. Go to **GreetingOptions**, and then press **menu/select**. The greeting currently being used will be played. If you want to use the other greeting, press the **CHANGE** soft key.

If you want to delete your greeting, press the **DELETE** soft key while the greeting is playing. (You can't delete the prerecorded greeting.)

From the handset

Press .

Press hi!/6. The greeting currently being used will be played. If you want to use the other greeting, press the key again.

If you want to delete your greeting, press the /4 while the greeting is playing (You can't delete the prerecorded greeting.)

Using the Answering Machine

Turning On the Answering Machine

From the Handset

You can turn on/off the machine using handset remote function. Select . Press



/9. Each time the key is pressed the setting switches between On and Off.

From the Base

With the phone in standby mode, press **answer on/off**. MESSAGE appears on the display. If the number is flashing, then there are new messages waiting for you. To turn your answering machine off, press **answer on/off**.

ANSWER OFF appears.



- You can't delete unheard messages. If you try to delete messages before listening to them, the answering machine will beep and say "Please playback all messages."
- If you press |<< during the first two seconds (or press ⏮/1 during the first 4 seconds) of a message, the answering machine goes back to the previous message.

Reviewing Messages

When you have a new message, the new message LED on the handset blinks and ✉ appears on the handset. On the base, **NEW** appears. The LED stops blinking when you've listened to all your new messages. The answering machine plays your new messages first. After you play all your new messages, you can then play your old messages.

You can review your messages from the base or from the handset:

	From the base	From the handset
Playing your messages	Press ▷◻. The answering machine tells you how many new and old messages you have. It announces the message number, plays the message, then announces the time and date that message was received.	Press ✉, The phone tells you how many new and old messages you have. Press ▶/2 to play your messages. It announces the message number. After playing the message, the answering machine announces the time and date that message was received.
Repeating a message	Press the << soft key once to go to the beginning of the current message. Press the << soft key repeatedly to go back to a previous message. Press and hold the << soft key to rewind through the current message.	Press ⏮/1 once to go to the beginning of the current message. Press ⏮/1 repeatedly to go back to a previous message.
Skipping a message	Press the >> soft key to go to the beginning of the next message. Press and hold the >> soft key to fast forward through the current message.	Press ⏭/3 to go to the beginning of the next message. Press and hold ⏭/3 to fast forward through the current message.
Delete a message	While a message is playing, press ⌫ to delete it. The message is permanently deleted.	While a message is playing, press ⌫/4 to delete it. The message is permanently deleted.
Delete all messages	While the phone is in standby, press ⌫ to delete all messages. When the answering machine asks you to confirm, press ⌫ again. All messages are permanently deleted.	(This command is not available on the handset.)
Stop reviewing messages	Press ▷◻ to stop the message playback and return to standby.	Press ◻/5 to stop the message playback. Press <i>end</i> to exit the message system and return to standby.

Recording a phone conversation

You can record a phone conversation with your handset or base. The conversation has to last more than two seconds and less than ten minutes. During a conversation, press **menu/select**. Use the up/down key to select **Call Record**. The handset or the base sounds a confirmation tone that can be heard by both parties and displays **Recording a Call**. When you want to stop recording, press **menu/select** and select **Call Record** again.

Screening Calls

You can screen calls from the base: just let the answering machine answer the call and listen to the caller leave a message. Answer the phone if you want to talk to the caller. To mute the call screen, press **▷◻**.

If you turn on the call screen feature (see page 75), you can also screen calls from the handset. Let the answering machine answer the call, then press the volume up key. If you want to talk to the caller, just press **talk/flash**, and the answering machine will stop recording. To mute the call screen, press **end**.



- If the recording memory is full, **Unavailable** appears in the display. You can not record a conversation until you clear some messages from the memory.
- Every state has different regulations governing the recording of conversations over the telephone. Make sure to check your local, state and federal laws before using this product to record any telephone conversation in order to determine that your use is in compliance with such laws or guidelines.
- You can not record intercom conversations.
- Only one handset can screen calls at a time. If another handset is screening the call, you'll just hear a beep when you try to screen the call, too.

Do Not Disturb (DND)





The do not disturb feature (DND) allows you to mute the ringer of the base and any registered handsets at the same time. The phone must be in standby mode. Press and hold **dnd** on the base. You will hear a confirmation tone, and the dnd LED illuminates. To cancel the DND feature, press **dnd** again. You can also mute the ringer tone while the phone is ringing by pressing **dnd** on the base.

Activating the DND while the answering system is off will turn the answering system on automatically. The answering system setting will reset to the original setting when you cancel the DND.

Recording a voice memo

The voice memo function allows the user to record messages (more than 2 seconds and less than 4 minutes). To record your memo, press **menu/select** on the base. Select **Record Memo** and press **menu/select**. Press the **START** soft key. After the answering machine says, "Record memo message," you can start recording. When you're finished, press the **STOP** soft key. You will hear a confirmation tone.

You can also record a voice memo remotely, press .

Press   /7. After the answering machine says, "Record Memo Message," you can start recording. When you're finished, press   /7 key.

Remote Operation

You can check, play, or delete messages when you are away from home. You can also record your own greeting message. To access your answering machine remotely, you need a touch tone telephone and a two-digit security code (see Setting a Security Code on page 73).

- 1) Call your telephone number and wait for the system to answer. If Toll Saver is enabled, answering machine will answer in 2 rings if you have new messages and 4 rings if you don't. If the answering machine is off, it will answer after about 10 rings and sound a series of beeps.
- 2) During the greeting message (or a series of beeps when the answering machine is off), press **0** and enter your security code within two seconds.
- 3) The answering machine announces the current time and the number of messages stored in memory. You hear "To play incoming messages, press zero-two. For help, press one-zero." Then, you'll hear a beep.
- 4) Enter a command from the following chart within 15 seconds. After the first command, you have two seconds to enter each command.



- The system will only play back messages for four minutes, and then it returns to the command waiting mode. To continue playing your messages, press 0 then 2 again within 15 seconds.
- If you enter an incorrect security code three times, you will hear a beep and the system will return to standby.
- For your convenience, a remote operation card is provided for you to use while away from home (refer to page 100).

Command	Function	Command	Function
0 then 1	Repeat a Message*	0 then 6	answering machine On
0 then 2	Play incoming Messages	0 then 7	Memo Record/Stop**
0 then 3	Skip a Message	0 then 8	Greeting Message Record/ Stop**
0 then 4	Delete a Message	0 then 9	answering machine Off
0 then 5	Stop Operation	1 then 0	Help

* For the Repeat a Message function, press **0 then 1** within about 4 seconds to repeat the previous message, or press **0 then 1** after about 4 seconds to repeat the current message.

** The first time you enter the Memo Record or the Greeting Message Record command, the answering machine will start recording. Enter the same command again to stop recording.

- 5) After the command has finished, you hear intermittent beeps indicating that the system is in the command waiting mode. You can enter another command from the chart, or you can hang up to exit the system.
- 6) When you hang up, the answering machine automatically returns to standby.

Multi-Handset Features

The features in this section require a minimum of two handsets to operate. To add additional handsets to your system, see "Expanding Your Phone" on page 12.

Using DirectLink Mode

In DirectLink Mode, a pair of handsets can function as two-way radios. DirectLink Mode does not interfere with the main base's ability to make or receive telephone calls. You must set both handsets to DirectLink Mode to make a directlink call.

To enter DirectLink mode, Select Direct Link option in the main menu. And then press the **ENTER** soft key. *DirectLink Mode complete.* appears when you enter the DirectLink Mode.

To make a DirectLink call, press the **DirectLink** soft key. Select the handset you want to call. To cancel the call, Press **end**. To answer a DirectLink call, press **talk/flash** or **⏏** on the side of the handset.

Press **end** when you want to hang up.

To exit DirectLink mode and be able to receive normal phone calls again, press the **CANCEL** soft key, and then press the **OK** soft key.

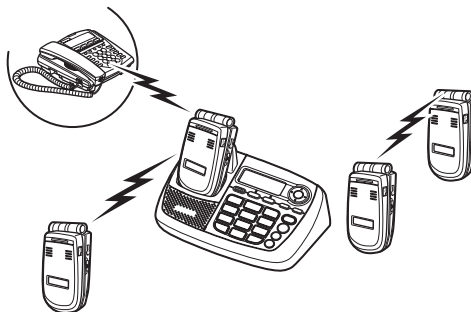

- If the party is out of range, *No Signal* appears in the display, and the operation will be canceled.
- While a pair of handsets are in DirectLink mode, they cannot be used to make or receive calls. Other handsets can still make and receive calls.



- This feature only works when the handset is within the range of the base.
- If the party is out of range, *Unavailable* appears in the display, and the operation will be canceled.

Room/Baby Monitor

This feature allows you to monitor sounds in another room. Place a handset or the base in the room you wish to monitor; it will function as a microphone. A second handset or the base can be used as a remote speaker, allowing you to monitor sounds in the room.

Using Room/Baby Monitor

To enter Room Monitor mode, press **menu/select**. Then select the Room Monitor. Select the handset or base you want to monitor. Press **end** or **end/find hs** when you want to stop monitoring.

To prevent the monitoring of a particular handset or the base, simply turn off the Room Monitor feature on that handset or on the base.

To turn off the Room Monitor, go to System Setup, Base/Handset Setup Menu, and then **Room Monitor**. Select **Off**. You will hear a confirmation tone.

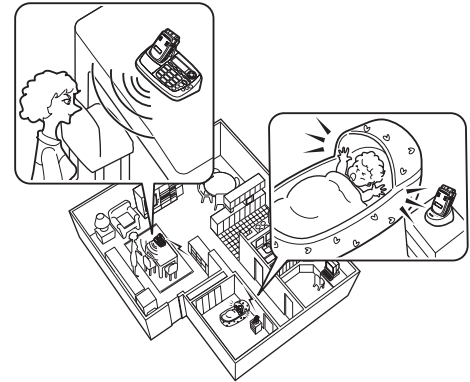

Intercom

You can use the intercom to talk to another handset or base without using the phone line. While the phone is in standby mode, press **back/hold/int'com**. Select the handset or base you want to page. If you select All, all other handsets and the base will be paged.

If the handset or base you're trying to page is busy, the phone displays `System busy Please try later`. If the handset you're trying to page is out of range, the phone displays `No Signal`. Press `HELP`. The page is canceled.

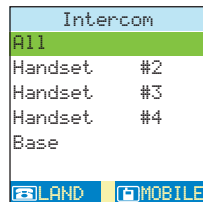

Answering an intercom page

When the handset receives an intercom page, it sounds a tone and shows the ID of the handset that is paging. If you page the base, `Base` appears. To answer the page, pick up the handset and press **talk/flash**, **⏏**, or **back/hold/int'com** on the handset, **📞/flash** or **back/hold/int'com** on the base.

- If you receive an outside/int'com call or page while selecting the other handset, the operation is canceled.
- If the party does not answer within one minute, the operation is canceled.
- During an intercom call, if you receive a call, you will hear a ringer tone from the ear speaker.
- If all handsets or base are paged, only the first party to answer the page will connect.
- If you do not select a handset or base within 30 seconds, the operation will be canceled.

To hang up an intercom page, press **end** on either side of the handset or **end/find** **hs** on the base.



You can not transfer a land line call to a Bluetooth mobile phone.

Transferring a Call

You can transfer a call from one handset or the base to another. During a call, press **back/hold/int'com**; this will put the call on hold. Select the handset or base you want to page. If you select **All**, all other handsets and base will be paged. To cancel the page and go back to the caller, press **talk /flash** on the handset or **Ⓜ/flash** on the base.

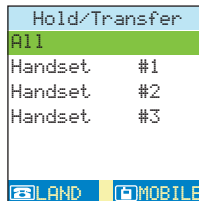

Answering a transfer page

When the handset receives a transfer page, it sounds a tone and shows the ID of the handset that is paging. If you page the base, **Base** appears. Press **talk/flash** or **back/hold/int'com** on the handset, or **Ⓜ/flash** or **back/hold/int'com** on the base to answer the page. If you want to accept the transfer and talk to the outside caller, press **talk/flash** or **back/hold/int'com** on the handset, or **Ⓜ/flash** or **back/hold/int'com** on the base.

Note on Power Sources

Power Failure

Your phone has a backup battery in the base that provides power backup in the event of a power failure.

Battery replacement and handling

When the operating time becomes short, even after the battery is recharged, please replace the battery. With normal usage, your battery should last about one year.

Warning

To avoid the risk of personal injury or property damage from fire or electrical shock, use only Uniden AD-0009 AC adapters and Uniden BT-0002 and BT-446 battery packs with your phone.

Caution

- Use only the specified Uniden battery pack (BT-0002 and BT-446).
- Do not remove the batteries from the handset to charge them.
- Never throw the battery into a fire, disassemble them, or heat them.
- Do not remove or damage the battery casing.



- A replacement Uniden adapter or battery may be purchased by calling Uniden's Parts department (see back cover page).
- Use only the Uniden (BT-0002 and BT446) rechargeable battery packs supplied with your cordless phone.

General Information

The phone complies with FCC Parts 15 and 68. Operating temperature:
0 °C to +50 °C (+32 °F to +122 °F)

AC Adapter Information

AC Adapter part number: AD-0009
Input Voltage: 120V AC 60Hz
Output Voltage: 9V DC 600mA

Battery Information

Battery part number:	BT-0002 (Handset)	BT-446 (Base)
Capacity:	980mAh, 3.7V	800mAh, 3.6V

Specifications, features, and availability of optional accessories are all subject to change without prior notice.

Troubleshooting



If your phone is not performing to your expectations, please try these simple steps first. If these steps do not solve your problem, please call our Customer Hotline at 1-800-297-1023. (Mon - Fri 7 am to 7 pm, Sat/Sun 9 am to 5 pm, CST. Phone support is closed on holidays.)

Symptom	Suggestion
The charge LED won't illuminate when the handset is placed in the cradle.	<ul style="list-style-type: none">• Make sure the AC adapter is plugged into the base or the charger (if you have more than one handset) and wall outlet.• Make sure the handset is properly seated in the cradle.• Make sure the charging contacts on the handset are clean.
The audio sounds weak.	<ul style="list-style-type: none">• Move the handset and/or base away from metal objects or appliances and try again.• Make sure that you are not too far from the base.
Can't make or receive calls.	<ul style="list-style-type: none">• Make sure that you are not too far from the base.• Make sure the line is not in use. If an outside call is already using a line, you cannot use that line to make another outside call.• Check both ends of the base telephone line cord.• Make sure the AC adapter is plugged into the base and wall outlet.• Disconnect the AC adapter and the backup battery and reconnect.• Change the Digital Security Code (see page 15).
The handset doesn't ring or receive a page.	<ul style="list-style-type: none">• Make sure that you are not too far from the base.• Charge the battery in the handset for 10 hours by placing the handset on the base or charging cradle.• Change the Digital Security Code (see page 15).
Severe noise interference.	<ul style="list-style-type: none">• Keep the handset away from microwave ovens, computers, remote control toys, wireless microphones, alarm systems, intercoms, room monitors, fluorescent lights, and electrical appliances.• Move to another location or turn off the source of interference.

Symptom	Suggestion
The Caller ID does not display.	<ul style="list-style-type: none"> • The call was placed through a switchboard. • Call your local telephone company to verify your Caller ID service is current. There may be a problem with your Caller ID service.
You cannot register the handset at the base.	<ul style="list-style-type: none"> • Charge the battery pack in the handset for 10 hours. • Change the Digital Security Code (see page 15).
The handset doesn't communicate with other handsets.	<ul style="list-style-type: none"> • Change the Digital Security Code (see page 15). • Make sure that you have registered all handsets.
An extra handset can't join the conversation.	<ul style="list-style-type: none"> • Make sure there are not 2 handsets already using the conference feature. • Make sure that another handset is not in privacy mode.
The Room Monitor feature does not work.	<ul style="list-style-type: none"> • Make sure to place the handset(s) within the range of the base. • Make sure that Room Monitor feature is turned on.
The answering machine does not work.	<ul style="list-style-type: none"> • Make sure the base unit is plugged in. • Make sure that the answering machine is turned on. • Make sure that the message record time is not set to Announce only (see page 74).
Messages are incomplete.	<ul style="list-style-type: none"> • The incoming messages may be too long. Remind callers to leave a brief message. • The memory maybe full. Delete some or all of the saved message.
There is no sound on the base unit or handset speaker during call monitoring or message playback.	<ul style="list-style-type: none"> • Adjust the speaker volume on the base unit or handset. • Make sure the call screen feature is set to on.

Symptom	Suggestion
Cannot access remote call-in features from another touchtone phone.	<ul style="list-style-type: none"> • Make sure you are using the correct PIN number. • Make sure that the touch-tone phone you're using can transmit the tone for at least two seconds. If it cannot, you may have to use another phone to access your phone.
Time stamp cannot be heard.	<ul style="list-style-type: none"> • Make sure you have set the time (see "Setting Date and Time" on page 28).

Bluetooth Troubleshooting

Symptom	Suggestion
Unable to pair headset and/or mobile phone to my ELBT595/ELBT585/ELX500	<ul style="list-style-type: none"> • Make sure your device is Bluetooth enabled. • Make sure the cordless handset has Bluetooth feature set to ON and not OFF. • Confirm correct PIN Code is being entered. • Pairing methods may vary by per mobile phone. First try pairing with Search  Device mode. The device may seem connected, but when you try using, it doesn't work. In this case, try the second option, Find Me mode. • Make sure your mobile phone is still registered to the base unit. Review paired devices under Select  Mobile option at base unit. • Make sure your mobile supports Hands Free Profile (HFP). • Make sure your Bluetooth headset supports Headset Profile (HSP).

Symptom	Suggestion
Unable to make or receive calls using Bluetooth headset and/or mobile phone.	<ul style="list-style-type: none"> • Make sure your Bluetooth headset is in close range of the cordless handset it's paired with. • Make sure your mobile phone is in close range of the main base unit. (In theory, you have a range of 30 feet /10 meters line of sight. Walls or other intervening objects may require you to move closer to the base). • Make sure the Auto Answer feature on your Bluetooth mobile phone is turned off. If AutoAnswer is On, your mobile may answer the call and interrupt your ELBT595. If this happens, the ELBT595 will place the call on hold. • Register only one Bluetooth device to your ELBT595 and try again. • Make sure your mobile supports Hands Free Profile (HFP). • Make sure your Bluetooth headset supports Headset Profile (HSP). • Deregister your Bluetooth headset or mobile phone, and register it again.
Unable to hear any voice.	<ul style="list-style-type: none"> • Check to see if your Bluetooth mobile phone requires a special setting to let you talk while the mobile phone is on hook (for example, the Sony Ericson T610/T637/616 requires a special setting).

System Reset

De-register the Handset

- 1) Press and hold **end** and **#** for more than 5 seconds. Select Deregister HS.
- 2) The phone will ask you to confirm the deregistration. Select Yes.

When the base information is deleted, the handset displays

MUST place handset in base to register! Models may vary, refer to Owners Manual for help. Re-register the handset to the base (see page 13).

Replacing the Base Setting

- 1) Press and hold **end** and **#** for more than 5 seconds. Select Replacing Base. Replacing Base appears.
- 2) Select Yes.
- 3) You will hear a confirmation tone. The base information will be deleted.

When the base information is deleted, the handset displays

MUST place handset in base to register! Models may vary, refer to Owners Manual for help. Re-register the handset to the base (see page 13).

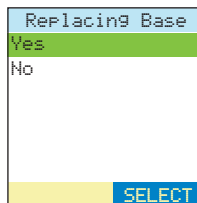
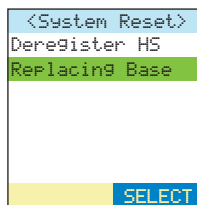
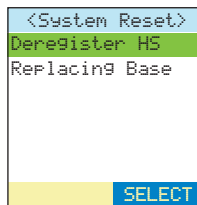

Liquid Damage

Moisture and liquid can damage your cordless phone. Follow the steps below if your phone gets wet:

Case	Action
If the handset or base is exposed to moisture or liquid, but only the exterior plastic housing is affected.	Wipe off the liquid, and use as normal.
If moisture or liquid has entered the plastic housing (i.e. liquid can be heard in the phone or liquid has entered the handset battery compartment or vent openings on the base).	<p>Handset:</p> <ol style="list-style-type: none"> 1) Remove the battery cover and leave it off for ventilation. 2) Disconnect the battery pack. Leave the battery cover off and the battery pack disconnected for at least 3 days. 3) Once the handset is completely dry, reconnect the battery pack and the battery cover. 4) Recharge the handset's battery pack for 20 hours before using. <p>Base:</p> <ol style="list-style-type: none"> 1) Disconnect the AC adapter from the base, cutting off electrical power. 2) Disconnect the telephone cord from the base. 3) Let dry for at least 3 days. <p>IMPORTANT: You must unplug the telephone line while recharging the battery packs to avoid charge interruption.</p> <p>CAUTION: DO NOT use a microwave oven to speed up the drying process. This will cause permanent damage to the handset, base and the microwave oven.</p> <p>After following these steps, if your cordless telephone does not work, please call our Customer Service Hotline at 1-800-297-1023.</p>

Precautions!

Before you read anything else, please observe the following:

Warning!

Uniden America Corporation DOES NOT represent this unit to be waterproof. To reduce the risk of fire, electrical shock, or damage to the unit, DO NOT expose this unit to rain or moisture.

Rechargeable Lithium Ion and Nickel-Metal-Hydride Battery Warning

- This equipment contains rechargeable Lithium Ion and Nickel-Metal-Hydride battery.
- The rechargeable batteries contained in this equipment may explode if disposed of in a fire.
- Nickel is a chemical known to state of California to cause cancer.
- Do not short-circuit the battery.
- Do not charge the rechargeable battery used in this equipment in any charger other than the one designed to charge this battery as specified in the owner's manual. Using another charger may damage the battery or cause the battery to explode.

Rechargeable Batteries Must Be Recycled or Disposed of Properly



The exclamation point within an equilateral triangle is intended to alert the user to the presence of important operating and maintenance (servicing) instructions in the literature accompanying the appliance.

Uniden works to reduce lead content in our PVC coated cords in our products and accessories.

Warning!

The cords on this product and/or accessories contain lead, a chemical known to the State of California to cause birth defects or other reproductive harm. **Wash hands after handling.**

Important Safety Instructions

When using your telephone equipment, basic safety precautions should always be followed to reduce the risk of fire, electric shock and injury to persons, including the following:

1. Do not use this product near water, for example, near a bath tub, wash bowl, kitchen sink or laundry tub, in a wet basement or near a swimming pool.
2. Avoid using a telephone (other than a cordless type) during an electrical storm. There may be a remote risk of electric shock from lightning.

3. Do not use the telephone to report a gas leak in the vicinity of the leak.
4. Use only the power cord and batteries indicated in this manual. Do not dispose of batteries in a fire. They may explode. Check with local codes for possible battery disposal instructions.
5. Do not disassemble any component of this product.

SAVE THESE INSTRUCTIONS

CAUTION

Risk of explosion if battery is replaced by an incorrect type. Dispose of used batteries according to the instructions. Do not open or mutilate the battery, and disconnect the battery before shipping this product.

The FCC Wants You To Know

This equipment complies with Part 68 of the FCC rules and the requirements adopted by the ACTA. On the bottom of this equipment is a label that contains, among other information, a product identifier in the format US:AAAEQ#TXXXX. If requested, this number must be provided to the telephone company.

An applicable Universal Service Order Codes (USOC) certification for the jacks used in this equipment is provided (i.e., RJ11C) in the packaging with each piece of approved terminal equipment.

A plug and jack used to connect this equipment to the premises wiring and telephone network must comply with the applicable FCC Part 68 rules and requirements adopted by the ACTA. A compliant telephone cord and modular plug is provided with this product. It is designed to be connected to a compatible modular jack that is also compliant. See installation instructions for details.

The REN is used to determine the number of devices that may be connected to a telephone line. Excessive RENs on a telephone line may result in the devices not ringing in response to an incoming call. In most but not all areas, the sum of RENs should not exceed five (5.0). To be certain of the number of devices that may be connected to a line, as determined by the total RENs, contact the local telephone company. For products approved after July 23, 2001, the REN for this product is part of the product identifier that has the format US:AAAEQ#TXXXX. The digits represented by # are the REN without a decimal point (e.g., 03 is a REN of 0.3). For earlier products, the REN is separately shown on the label.

If this equipment causes harm to the telephone network, the telephone company will notify you in advance that temporary discontinuance of service may be required. But if advance notice isn't practical, the telephone company will notify the customer as soon as possible. Also, you will be advised of your right to file a complaint with the FCC if you believe it is necessary.

The telephone company may make changes in its facilities, equipment, operations or procedures that could affect the operation of the equipment. If this happens the telephone company will provide advance notice in order for you to make necessary modifications to maintain uninterrupted service.

Please follow instructions for repairing, if any (e.g. battery replacement section); otherwise do not substitute or repair any parts of the device except as specified in this manual. Connection to party line service is subject to state tariffs. Contact the state public utility commission, public service commission or corporation commission for information. This equipment is hearing aid compatible.

Should you experience trouble with this equipment, please contact Uniden customer service at 800-297-1023. If the equipment is causing harm to the telephone network, the telephone company may request that you disconnect the equipment until the problem is resolved.

NOTICE: According to telephone company reports, AC electrical surges, typically resulting from lightning strikes, are very destructive to telephone equipment connected to AC power sources. To minimize damage from these types of surges, a surge arrester is recommended.

Changes or modifications to this product not expressly approved by Uniden, or operation of this product in any way other than as detailed in the owner's manual, could void your authority to operate this product.

This device complies with part 15 of the FCC rules. Operation is subject to the following two conditions: (1) This device may not cause harmful interference, and (2) This device must accept any interference received, including interference that may cause undesired operation. Privacy of communications, may not be ensured when using this phone. To insure the safety of users, the FCC has established criteria for the amount of radio frequency energy various products may produce depending on their intended usage. This product has been tested and found to comply with the FCC's exposure criteria. For body worn operation, the FCC RF exposure guidelines were also met when used with the Uniden accessories supplied or designed for this product. Use of other accessories may not ensure compliance with FCC RF exposure guidelines and should be avoided.

Radio Interference

Radio interference may occasionally cause buzzing and humming in your cordless handset, or clicking noises in the base. This interference is caused by external sources such as TV, refrigerator, vacuum cleaner, fluorescent lighting, or electrical storm. Your unit is NOT DEFECTIVE. If these noises continue and are too distracting, please check around your home to see what appliances may be causing the problem. In addition, we recommend that the base not be plugged into a circuit that also powers a major appliance because of the potential for interference. Be certain that the antenna on the unit is fully extended when needed.

In the unlikely event that you consistently hear other voices or distracting transmissions on your phone, you may be receiving radio signals from another cordless telephone or other source of interference. If you cannot eliminate this type of interference, you need to change to a different channel.

Finally, it should be noted that some cordless telephones operate at frequencies that may cause interference to nearby TVs and VCRs. To minimize or prevent such interference, the base of the cordless telephone should not be placed near or on top of a TV or VCR. If interference is experienced, moving the cordless telephone farther away from the TV or VCR will often reduce or eliminate the interference.

Cordless Telephone Privacy

Cordless telephones are radio devices. Communications between the handset and base of your cordless telephone are accomplished by means of radio waves which are broadcast over the open airways. Because of the inherent physical properties of radio waves, your communications can be received by radio receiving devices other than your own cordless telephone unit. Consequently, any communications using your cordless telephone may not be private.

One Year Limited Warranty

Important: Evidence of original purchase is required for warranty service.

WARRANTOR: UNIDEN AMERICA CORPORATION ("Uniden") **ELEMENTS OF WARRANTY:** Uniden warrants, for one year, to the original retail owner, this Uniden Product to be free from defects in materials and craftsmanship with only the limitations or exclusions set out below.

WARRANTY DURATION: This warranty to the original user shall terminate and be of no further effect 12 months after the date of original retail sale. The warranty is invalid if the Product is (A) damaged or not maintained as reasonable or necessary, (B) modified, altered, or used as part of any conversion kits, subassemblies, or any configurations not sold by Uniden, (C) improperly installed, (D) serviced or repaired by someone other than an authorized Uniden service center for a defect or malfunction covered by this warranty, (E) used in any conjunction with equipment or parts or as part of any system not manufactured by Uniden, or (F) installed or programmed by anyone other than as detailed by the owner's manual for this product.

STATEMENT OF REMEDY: In the event that the product does not conform to this warranty at any time while this warranty is in effect, warrantor will either, at its option, repair or replace the defective unit and return it to you without charge for parts, service, or any other cost (except shipping and handling) incurred by warrantor or its representatives in connection with the performance of this warranty. Warrantor, at its option, may replace the unit with a new or refurbished unit. **THE LIMITED WARRANTY SET FORTH ABOVE IS THE SOLE AND ENTIRE WARRANTY PERTAINING TO THE PRODUCT AND IS IN LIEU OF AND EXCLUDES ALL OTHER WARRANTIES OF ANY NATURE WHATSOEVER, WHETHER EXPRESS, IMPLIED OR ARISING BY OPERATION OF LAW, INCLUDING, BUT NOT LIMITED TO ANY IMPLIED WARRANTIES OF MERCHANTABILITY OR FITNESS FOR A PARTICULAR PURPOSE. THIS WARRANTY DOES NOT COVER OR PROVIDE FOR THE REIMBURSEMENT OR PAYMENT OF INCIDENTAL OR CONSEQUENTIAL DAMAGES.** Some states do not allow this exclusion or limitation of incidental or consequential damages so the above limitation or exclusion may not apply to you.

LEGAL REMEDIES: This warranty gives you specific legal rights, and you may also have other rights which vary from state to state. This warranty is void outside the United States of America and Canada.

PROCEDURE FOR OBTAINING PERFORMANCE OF WARRANTY: If, after following the instructions in the owner's manual you are certain that the Product is defective, pack the Product carefully (preferably in its original packaging). Disconnect the battery from the Product and separately secure the battery in its own separate packaging within the shipping carton. The Product should include all parts and accessories originally packaged with the Product. Include evidence of original purchase and a note describing the defect that has caused you to return it. The Product should be shipped freight prepaid, by traceable means, to warrantor at:

Uniden America Service
4700 Amon Carter Blvd.
Fort Worth, TX 76155

I.C. Notice

TERMINAL EQUIPMENT

NOTICE: This equipment meets the applicable Industry Canada Terminal Equipment Technical Specifications. This is confirmed by the registration number. The abbreviation, IC, before the registration number signifies that registration was performed based on a Declaration of Conformity indicating that Industry Canada technical specifications were met. It does not imply that Industry Canada approved the equipment.

NOTICE: The Ringer Equivalence Number (REN) for this terminal equipment is marked on the equipment itself. The REN assigned to each terminal equipment provides an indication of the maximum number of terminals allowed to be connected to a telephone interface. The termination on an interface may consist of any combination of devices subject only to the requirement that the sum of the Ringer Equivalence Numbers of all the devices does not exceed five.

RADIO EQUIPMENT

The term "IC:" before the radio certification number only signifies that Industry Canada technical specifications were met.

Operation is subject to the following two conditions: (1) this device may not cause interference, and (2) this device must accept any interference, including interference that may cause undesired operation of the device. "Privacy of communications may not be ensured when using this telephone".

Index

A

Animations	37
Answering machine	
Answering Mode	72
Call screen	75
Message alert	75
Security code	73
Setting up menu	73
Anykey Answer	25
Area code	29
Audio tone	59

B

Backup battery	7
Banner	26
Battery	
Installation	8
Replacement	87

Bluetooth feature

Headset

De-registering	47
Handset property	45
Reconnect	47
Reconnecting	44
Turning on or off	46

Mobile

Base property	42
De-registering	40
Editing	41
Registering	38

C

Calendar	61
--------------------	----

Call privacy	26
Call screen	75
Call transfer feature	86
Call Vibrate	33
Caller ID	
Call Waiting	52
CIDCW	70
CWDX	52
Color scheme	36
Conference	53

D

Date & time	28
Delete ringer	35
De-registering handset	93
Dial mode	30
Digital security code	15
DirectLink	83
Display Option	23
Distinctive ID	27

E

Earpiece volume	57
Expanding your phone	12

F

Find handset	60
------------------------	----

G

General information	88
Global setup	28

H

Hands-free conversation	49
Hanging up	51
Headset installation	16
Hold	53

Holster	15
-------------------	----

I

I.C. notice	97
Important safety instructions	95
Intercom	85

K

Key touch tone	26
--------------------------	----

L

Language	27, 37, 75
LCD contrast	25
Liquid damage	94
Low battery	9

M

Making a call	48
Message alert	75
Mobile priority	24
Mute	
Handset ringer	59
Microphone	59

O

Open to Answer	25
Out going greeting	
Choosing	76
Recording	76
Out of range	51

P

Phonebook	
Capacity	68
Copying entries	67
Group	65
Making calls	69
Name	64

Number	64	Soft key	20
Sort order	68	Speaker phone	49
Speed dial	65	Speaker volume	
Unique display	65	Base	57
Unique ring	64	Handset	59
Power failure	87	Storing a caller ID or redial number	66
Precautions	95	System setup	24
Privacy mode	26	T	
R		Tone dial	60
Receiving a call	50	Transferring a call	86
Record ringer	33	Troubleshooting	89
Record time	74	U	
Recording conversation	79	Uniden's Cordless Telephone	
Redialing a call	56	Customization Tool	17
Register the handset	13	Unique ID	27
Reminder	61	Unique ring	32
Remote operation	81	V	
Reviewing message	78	Vibrate All	32
Ring time	74	W	
Ringer tone		Wallpaper	35
Changing	34	Warranty	96
Deleting	35		
Playing	34		
Storing	33		
Ringer volume			
Base	57		
Handset	58		
Room/baby monitor	84		
S			
Setting up			
Answering Machine	73		
Base unit	10		
Telephone Line	10		

Remote Operation Card

CUT

REMOTE OPERATION CARD

Uniden®

Remote access away from home

1. Call your phone number from a touch-tone phone.
2. During the outgoing message, press 0 and enter your PIN code. The answering system announces the number of messages stored in memory and the voice prompts.
3. To quit, hang up the phone.

Turn on the answering system remotely

1. Call your phone and let it ring 10 times until you hear a beep.
2. Press 0 and then enter your PIN code.
3. Press 0 then 5 to stop the announcement.
4. Press 0 then 6 to turn the answering system on.

CUT

REMOTE OPERATION CARD

Uniden®

Remote access away from home

1. Call your phone number from a touch-tone phone.
2. During the outgoing message, press 0 and enter your PIN code. The answering system announces the number of messages stored in memory and the voice prompts.
3. To quit, hang up the phone.

Turn on the answering system remotely

1. Call your phone and let it ring 10 times until you hear a beep.
2. Press 0 and then enter your PIN code.
3. Press 0 then 5 to stop the announcement.
4. Press 0 then 6 to turn the answering system on.

CUT

REMOTE OPERATION CARD

Uniden®

Remote access away from home

1. Call your phone number from a touch-tone phone.
2. During the outgoing message, press 0 and enter your PIN code. The answering system announces the number of messages stored in memory and the voice prompts.
3. To quit, hang up the phone.

Turn on the answering system remotely

1. Call your phone and let it ring 10 times until you hear a beep.
2. Press 0 and then enter your PIN code.
3. Press 0 then 5 to stop the announcement.
4. Press 0 then 6 to turn the answering system on.

CUT

REMOTE OPERATION CARD

Uniden®

Remote access away from home

1. Call your phone number from a touch-tone phone.
2. During the outgoing message, press 0 and enter your PIN code. The answering system announces the number of messages stored in memory and the voice prompts.
3. To quit, hang up the phone.

Turn on the answering system remotely

1. Call your phone and let it ring 10 times until you hear a beep.
2. Press 0 and then enter your PIN code.
3. Press 0 then 5 to stop the announcement.
4. Press 0 then 6 to turn the answering system on.

CUT

Task	Key
Repeat a Message	0 1
Playing incoming Messages	0 2 abc
Skipping a Message	0 3 def
Deleting a Message	0 4 ghi
Stop Operation	0 5 jkl
Answering System On	0 6 mnop
Memo Record/Stop	0 7 qrstu
Greeting Message Record/Stop	0 8 vwxyz
Answer System Off	0 9 wxyz
Help Guidance	1 0 opqr

CUT

Task	Key
Repeat a Message	0 1
Playing incoming Messages	0 2 abc
Skipping a Message	0 3 def
Deleting a Message	0 4 ghi
Stop Operation	0 5 jkl
Answering System On	0 6 mnop
Memo Record/Stop	0 7 qrstu
Greeting Message Record/Stop	0 8 vwxyz
Answer System Off	0 9 wxyz
Help Guidance	1 0 opqr

CUT

Task	Key
Repeat a Message	0 1
Playing incoming Messages	0 2 abc
Skipping a Message	0 3 def
Deleting a Message	0 4 ghi
Stop Operation	0 5 jkl
Answering System On	0 6 mnop
Memo Record/Stop	0 7 qrstu
Greeting Message Record/Stop	0 8 vwxyz
Answer System Off	0 9 wxyz
Help Guidance	1 0 opqr

CUT

Task	Key
Repeat a Message	0 1
Playing incoming Messages	0 2 abc
Skipping a Message	0 3 def
Deleting a Message	0 4 ghi
Stop Operation	0 5 jkl
Answering System On	0 6 mnop
Memo Record/Stop	0 7 qrstu
Greeting Message Record/Stop	0 8 vwxyz
Answer System Off	0 9 wxyz
Help Guidance	1 0 opqr

At Uniden, we'll take care of you!

Thank you for purchasing a Uniden product. If you have any questions or problems,
please do not return this product to the place of purchase.



Having Trouble?

Our customer care specialists are here to help you! Visit our website at www.uniden.com or call our customer hotline at **1-800-297-1023**, Mon-Fri, 7 a.m. to 7 p.m. or Sat/Sun, 9 a.m. to 5 p.m. CST. (Phone support is closed on holidays.)



Need a Part?

To order headsets, additional handsets, replacement batteries or other accessories, visit our website at www.uniden.com or call 1-800-554-3988, Mon-Fri, 8 a.m. to 5 p.m. CST.



Help for our Special Needs Customers

If you need special assistance due to a disability or have questions on the accessibility features of this product, please call **1-800-874-9314 (voice or TTY)**

Uniden®

May be covered under one or more of the following U.S. patents:

4,797,916	5,381,460	5,426,690	5,434,905	5,491,745	5,493,605
5,533,010	5,574,727	5,581,598	5,650,790	5,660,269	5,661,780
5,663,981	5,671,248	5,696,471	5,717,312	5,732,355	5,754,407
5,758,289	5,768,345	5,787,356	5,794,152	5,801,466	5,825,161
5,864,619	5,893,034	5,912,968	5,915,227	5,929,598	5,930,720
5,960,358	5,987,330	6,044,281	6,070,082	6,125,277	6,253,088
6,314,278	6,418,209	6,618,015	6,671,315	6,714,630	6,782,098
6,788,920	6,788,953				

Other patents pending.

FOR
ACCESSORIES,
GO ONLINE @
WWW.UNIDEN.COM

REGISTER ONLINE TODAY!

THANK YOU FOR BUYING A UNIDEN PRODUCT.

A World Without Wires | **Uniden®**

Free Manuals Download Website

<http://myh66.com>

<http://usermanuals.us>

<http://www.somanuals.com>

<http://www.4manuals.cc>

<http://www.manual-lib.com>

<http://www.404manual.com>

<http://www.luxmanual.com>

<http://aubethermostatmanual.com>

Golf course search by state

<http://golfingnear.com>

Email search by domain

<http://emailbydomain.com>

Auto manuals search

<http://auto.somanuals.com>

TV manuals search

<http://tv.somanuals.com>