

900 MHz Cordless

# EXAI 918

**voice** scramble



# uniden

*Operating Guide*

UDZZ01830ZC

*Cordless Integrated Answering Device with Caller ID*

# Precautions!

Before you read anything else,  
please observe the following:

## Warning!

Uniden America Corporation **DOES NOT** represent this unit to be waterproof. To reduce the risk of fire, electrical shock, or damage to the unit, **DO NOT** expose this unit to rain or moisture.

## Rechargeable Nickel-Cadmium Battery Warning

- This equipment contains a Rechargeable Nickel-Cadmium Battery.
- Cadmium is a chemical known to the state of California to cause cancer.
- The Rechargeable Nickel-Cadmium Battery contained in this equipment may explode if disposed of in a fire.
- **Do not** short-circuit the battery.
- **Do not** charge the Rechargeable Nickel-Cadmium Battery used in this equipment in any charger other than the one designed to charge this battery as specified in this Guide. Using another charger may damage the battery or cause the battery to explode.



## Rechargeable Nickel-Cadmium Batteries must be recycled or disposed of properly!

- Uniden voluntarily participates in an RBRC® industry program to collect and recycle nickel-cadmium batteries at the end of their useful life, when taken out of service within the United States. The RBRC® program provides a convenient alternative to placing used nickel-cadmium batteries into the trash or municipal waste stream, which is illegal in some areas.
- Through the RBRC® program, Uniden makes it easy for you to drop off the used battery at local retailers of replacement nickel-cadmium batteries. You may also contact your local recycling center for information on where to return the used battery. Please call 1-800-8-BATTERY for information on Ni-Cd battery recycling in your area. Uniden's involvement in this program is part of its commitment to protecting our environment and conserving natural resources.
- RBRC® is a registered trademark of the Rechargeable Battery Recycling Corporation.



The exclamation point within an equilateral triangle is intended to alert the user to the presence of important operating and maintenance (servicing) instructions in the literature accompanying the appliance.

# Controls and Functions (Caller ID)

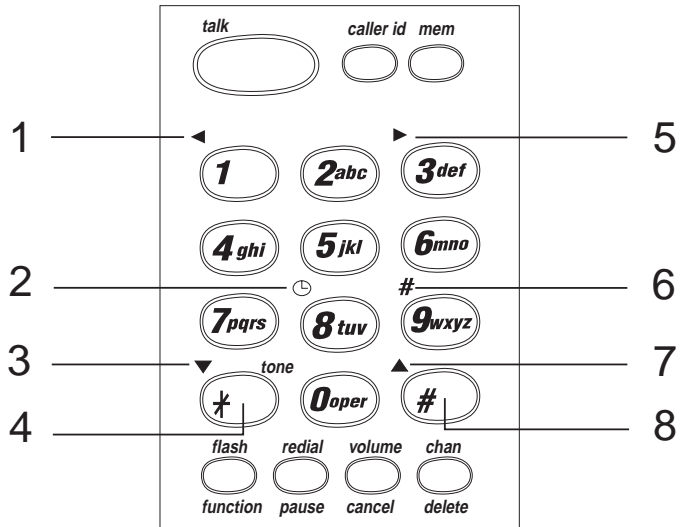

1. Backspace Key ◀
2. Caller Time Key ⊖
3. DownKey ▼
4. Tone Key \*

5. Forward Key ▶
6. Number of Calls #
7. Up Key ▲
8. Pound Key #

# Controls and Functions (Handset and Base)

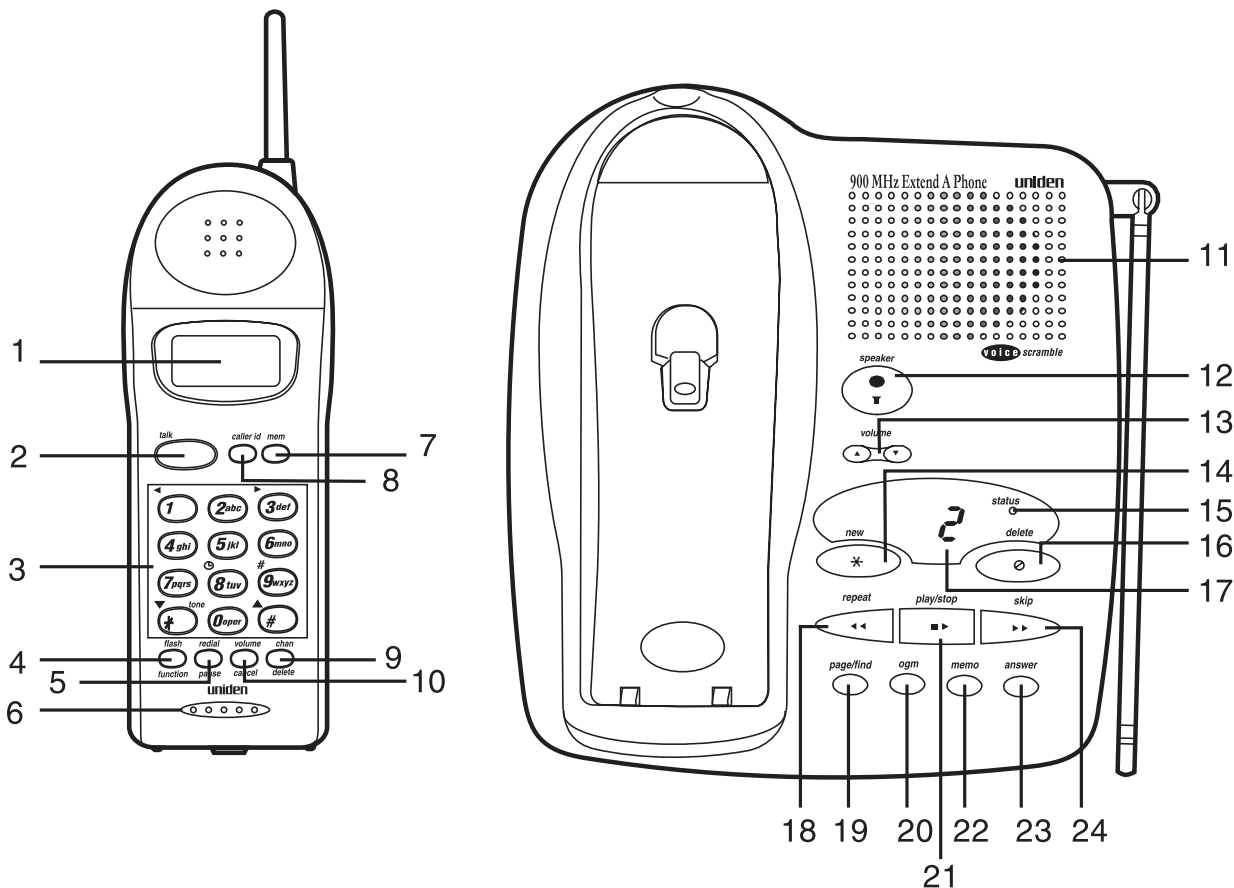

- |   |                                   |
|---|-----------------------------------|
| 1. LCD Display                              | 13. Speaker Volume Control Switch |
| 2. Talk Key <i>talk</i>                     | 14. New Message Button            |
| 3. Keypad (see breakout)                    | 15. Status LED                    |
| 4. Flash/Function Key <i>flash/function</i> | 16. Message Delete Button         |
| 5. Redial/Pause Key <i>redial/pause</i>     | 17. Message Counter LED           |
| 6. Microphone                               | 18. Message Repeat Button         |
| 7. Memory Key <i>mem</i>                    | 19. Page/Find Button              |
| 8. Caller ID Key <i>caller id</i>           | 20. Outgoing Message Button       |
| 9. Channel/Delete Key <i>chan/delete</i>    | 21. Message Play/Stop Button      |
| 10. Volume/Cancel Key <i>volume/cancel</i>  | 22. Memo Button                   |
| 11. Speaker                                 | 23. Answer On/Off Button          |
| 12. Speakerphone Button and LED             | 24. Message Skip Button           |

# Contents

Important Safety Instructions . . . . .	3
Battery Safety Precautions . . . . .	4
Introduction . . . . .	5
Features . . . . .	5
Included with the EXA1918 . . . . .	6
Important Electrical Considerations . . . . .	6
Range . . . . .	6
Telephone Line Problems . . . . .	6
Radio Interference . . . . .	7
More Than One Cordless Telephone . . . . .	7
Cordless Telephone Privacy . . . . .	7
Installation . . . . .	8
Selecting a Location . . . . .	8
Telephone Line Outlets . . . . .	8
Connecting the Telephone Cords . . . . .	8
Applying Power to the Base Unit . . . . .	9
Desk or Tabletop Installation . . . . .	10
Wall Installation . . . . .	10
Direct Wall Mounting . . . . .	11
Setting Up Your Phone . . . . .	13
Extending the Base Unit Antenna . . . . .	13
Installing the Handset Battery Pack . . . . .	13
Cleaning the Battery Contacts . . . . .	14
Charging the Battery Pack . . . . .	14
Low Battery Indicator . . . . .	14
Setting the Pulse/Tone Switch . . . . .	15
Automatic Digital Code Security . . . . .	15
Handset Volume Controls . . . . .	16
Channel Selector Button . . . . .	16
Entering the Local Area Code . . . . .	17
Setting the AutoTalk Feature . . . . .	18
Using Your Phone . . . . .	19
Making Calls . . . . .	19
Receiving Calls . . . . .	19
Redialing the Last Number Called . . . . .	20
Using the Flash Key with Call Waiting . . . . .	20
Using the Speakerphone . . . . .	20
Using Caller ID . . . . .	21
The Caller ID Display . . . . .	21
Viewing Calls in Memory . . . . .	21
Calling the Displayed Number . . . . .	22
Deleting Caller ID messages . . . . .	22
Programming Your Phone . . . . .	23
Storing a Caller ID memory number in Dial Memory . . . . .	23
Entering a Number in Dial Memory . . . . .	23
Calling a Number Stored in Memory . . . . .	24
Editing and Deleting Numbers in Dial Memory . . . . .	24
The Integrated Answering System . . . . .	26
Features . . . . .	26
Answering System Setup . . . . .	26
Turning the Answering System On/Off . . . . .	26
Setting the Clock . . . . .	26
Setting the PIN Code . . . . .	27
Setting Your Outgoing Message (OGM) . . . . .	27
Selecting a Preset OGM . . . . .	28

Setting the Toll Saver Switch . . . . .	28
Using the Reset Button . . . . .	28
VOX/Calling Party Control Feature . . . . .	28
Using Your Answering System . . . . .	29
Playing New Messages . . . . .	29
Playing Old Messages . . . . .	29
Repeating a Message . . . . .	29
Skipping a Message . . . . .	29
Deleting a Message . . . . .	30
Deleting All Messages . . . . .	30
Message Full Indication . . . . .	30
Leaving a Memo Message . . . . .	31
Remote Operation . . . . .	31
Troubleshooting . . . . .	32
Telephone Troubleshooting Chart . . . . .	32
Answering System Troubleshooting Chart . . . . .	33
Specifications . . . . .	34

# Important Safety Instructions

---

When using your telephone equipment, these basic safety precautions should always be followed to reduce the risk of fire, electrical shock, and injury to persons:

1. Read and understand all instructions.
2. Follow all warnings and instructions marked on the product.
3. Unplug this product from the wall outlet before cleaning, and use a dry cloth, without liquid or aerosol cleaners.
4. Do not use this product near water; for example, near a bath tub, wash bowl, kitchen sink or laundry tub, in a wet basement, or near a swimming pool.
5. Do not place this product on an unstable cart, stand, or table. The telephone may fall, causing serious damage to the unit.
6. Slots and openings in the cabinet and the back or bottom are provided for ventilation. To protect the product from overheating, these openings must not be blocked or covered. This product should never be placed near or over a radiator or heat register. This product should not be placed in a built-in installation unless proper ventilation is provided.
7. This product should be operated only from the type of power source indicated on the marking label. If you are not sure of the type of power supply to your home, consult your dealer or local power company.
8. Do not allow anything to rest on the power cord. Do not locate this product where the cord will be damaged by persons walking on it.
9. Do not overload wall outlets and extension cords, as this can result in the risk of fire or electrical shock.
10. Never push objects of any kind into this product through cabinet slots, as they may touch dangerous voltage points or short out parts that could result in a risk of fire or electric shock. Never spill liquid of any kind on the product.
11. To reduce the risk of electric shock, do not disassemble this product. Take it to qualified service personnel when service or repair work is required. Opening or removing covers may expose you to dangerous voltages or other risks. Incorrect reassembly can cause electric shock when the appliance is subsequently used.
12. Unplug this product from the wall outlet and refer servicing to qualified service personnel under the following conditions:
  - A. When the power supply cord is damaged or frayed.
  - B. If liquid has been spilled into the product.
  - C. If the product has been exposed to rain or water.
  - D. If the product does not operate normally when following the operating instructions. (Adjust only those controls that are covered by the operating instructions. Improper adjustment of other controls may result in damage and will often require extensive repair work by a qualified technician.)
  - E. If the product has been dropped or the cabinet has been damaged.
  - F. If the product exhibits a distinct change in performance.
13. Do not use the telephone to report a gas leak in the vicinity of the leak.

## Battery Safety Precautions

**Caution:** *To reduce the risk of fire or injury to persons by the battery, read and follow these instructions:*

1. Use only the appropriate type and size Battery Pack specified in this Operating Guide.
2. Do not dispose of the Battery Pack in a fire. The cell may explode. Check the Nickel-Cadmium Battery Disposal package insert for disposal instructions.
3. Do not open or mutilate the Battery Pack. Released electrolyte is corrosive and may cause damage to the eyes or skin. It may be toxic if swallowed.
4. Exercise care in handling the battery in order not to short the battery with conducting materials such as rings, bracelets, and keys. The battery or conductor may overheat and cause burns.
5. Charge the Battery Pack provided with or identified for use with this product only in accordance with the instructions and limitations specified in the instruction manual provided for this product.
6. Observe proper polarity orientation between the Battery Pack and battery charger.

**SAVE THESE INSTRUCTIONS**



# Introduction

---

Congratulations on your purchase of the EXAI918 telephone with an integrated digital answering system. This phone is designed to exacting standards to provide reliability, long life, and outstanding performance.

## Features

- Voice Scramble
- 900 MHz, 40 Channels
- 30 Number Caller ID Memory
- *AutoSecure*<sup>™</sup>
- *Random Code*<sup>™</sup> Digital Security
- Handset Ringer/Volume Controls
- UltraClear Plus
- Pulse/Tone Dialing
- *AutoTalk*<sup>™</sup>
- *AutoStandby*<sup>™</sup>
- 20-Number Memory
- 1-way Page/Find Button
- Redial/Flash Key
- 14 Day Battery Life

The Voice Scrambled EXAI918 protects your privacy by changing the RF signal between the Handset and Base Unit when you make or receive calls. This signal variation makes it difficult for someone to receive and understand your calls.

*AutoTalk*<sup>™</sup> allows you to answer a call by just removing the Handset from the Base Unit so you don't have to waste time pushing buttons or flipping switches. *AutoStandby*<sup>™</sup> allows you hang up by simply returning the Handset to the Base Unit.

The *UltraClear Plus* innovative technology, together with 40 different channels, virtually eliminates background noise and provides you with the best possible reception during all of your conversations.

To protect you against misbilled calls which might result from your phone being activated by other equipment, *Random Code*<sup>™</sup> digital security automatically selects one of over 65 thousand digital security codes for the Handset and Base Units. Also, the *AutoSecure*<sup>™</sup> feature electronically locks your phone when the Handset is in the Base Unit.

To get the most from your phone, please read this Operating Guide thoroughly. Also be sure to complete the Product Registration form and mail it in.

**Be sure to visit our Internet site at:  
<http://www.uniden.com>**

## Included with the EXAI918

If any of these items are missing or damaged, contact Uniden Parts at: (800) 554-3988, 8:00 am to 5:00 p.m. Central, Monday through Friday.

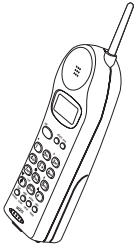

Handset

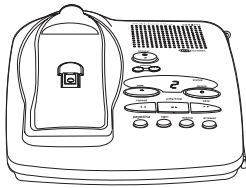

Base Unit

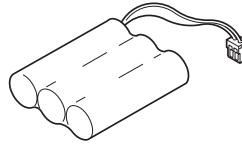

Rechargeable Battery

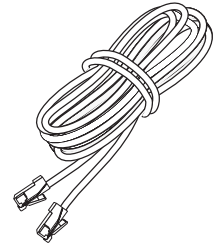

Long Telephone Cord

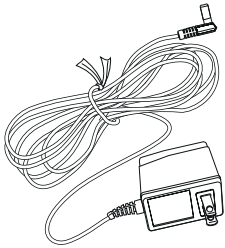

AC Adapter

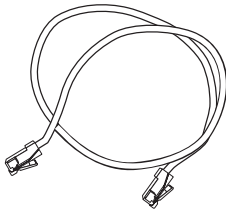

Short Telephone Cord

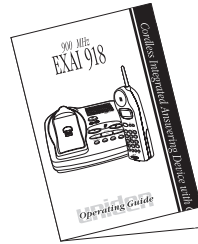

Operating Guide

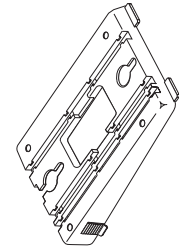

Wall Mount Adapter

Also included: Other Printed Material and Wall Mount Screws

## Important Electrical Considerations

Unplug all electrical appliances when you know an electrical storm is approaching. Lightning can pass through your household wiring and damage any device connected to it. This phone is no exception.

**Warning:** Please do not attempt to unplug any appliance during an electrical storm.

**Caution:** Changes or modifications to this product not expressly approved by Uniden, or operation of this product in any way other than as detailed by this Operating Guide, could void your authority to operate this product.

## Range

Your new phone is designed to achieve the maximum possible range by transmitting and receiving according to the highest specifications set forth by the FCC. We have rated this phone to operate at a maximum distance with the qualification that the range depends upon the environment in which the telephone is used. Many factors limit range, and it would be impossible to include all the variables in our rating. The Maximum Range rating of this phone is meant to be used as a means of comparison against other range claims.

## **Telephone Line Problems**

The FCC has granted the telephone company the right to disconnect service in the event that your phone causes problems on the telephone line. Also, the telephone company may make changes in facilities and services which may affect the operation of your unit. However, your telephone company must give adequate notice in writing prior to such actions to allow you time for making necessary arrangements to continue uninterrupted service.

If you are having trouble with your telephone service, you must first disconnect your phone to determine if it is the cause of your problem. If you determine that it is the cause, you must leave it disconnected until the trouble has been corrected.

## **Radio Interference**

Radio interference may occasionally cause buzzing and humming in your cordless Handset, or clicking noises in the Base Unit. This interference is caused by external sources such as TV, refrigerator, vacuum cleaner, fluorescent lighting, or electrical storm. Your unit is NOT DEFECTIVE. If these noises continue and are too distracting, please check around your home to see what appliances may be causing the problem. In addition, we recommend that the Base Unit not be plugged into a circuit that also powers a major appliance because of the potential for interference. Be certain that the antenna on the unit is fully extended when needed.

In the unlikely event that you consistently hear other voices or distracting transmissions on your phone, you may be receiving radio signals from another cordless telephone or other source of interference. If you cannot eliminate this type of interference, you need to change to a different channel.

Finally, it should be noted that some cordless telephones operate at frequencies that may cause interference to nearby TVs and VCRs. To minimize or prevent such interference, the base of the cordless telephone should not be placed near or on top of a TV or VCR. If interference is experienced, moving the cordless telephone farther away from the TV or VCR will often reduce or eliminate the interference.

## **More Than One Cordless Telephone**

If you want to use more than one cordless telephone in your home, they must operate on different channels. Press the channel key to select a channel that provides the clearest communication.

## **Cordless Telephone Privacy**

Cordless telephones are radio devices. Communications between the handset and base of your cordless telephone are accomplished by means of radio waves which are broadcast over the open airways. Because of the inherent physical properties of radio waves, your communications can be received by radio receiving devices other than your own cordless telephone unit. Consequently, any communications using your cordless telephone may not be private.

# Installation

## Selecting a Location

Before choosing a location for your new phone, there are some important guidelines you should consider:

- The location should be close to both a phone jack and continuous power outlet.

**Note:** A continuous power outlet is an AC outlet which does not have a switch to interrupt its power.

- Keep the Base Unit and Handset away from sources of electrical noise such as motors or fluorescent lighting.
- Be sure there is sufficient space to rotate the Base Unit antenna to fully vertical.
- The Base Unit can be placed on a desk or tabletop or mounted on a standard AT&T or GTE wall plate.
- If you decide to mount your phone on the wall, make sure to change the handset retainer so that the tab which holds the Handset faces up. (See page 12 for more information.)
- You should charge your new phone for 15-20 hours before completing the installation or using the Handset.



## Telephone Line Outlets

There are two types of phone outlets:

### Modular Jack

Most phone equipment available now uses modular jacks. Phone cords are fitted with a molded plastic connector which plugs into this type of jack. If you do not have modular phone jacks, contact your local telephone company for information about their installation.

### Hard-wired Jack

Some equipment is wired directly to a phone jack, and these types of installations require a modular jack converter. This type of installation is not difficult; however, you should contact your Uniden telephone dealer or a telephone supply store for advice about the proper adapter or converter for your situation.

## Connecting the Telephone Cords

Consider these safety guidelines before connecting the telephone cords:

*Caution!*

- *Never install telephone wiring during a lightning storm.*
- *Never touch uninsulated telephone wires or terminals unless the telephone line has been disconnected.*
- *Use caution when installing or modifying telephone lines.*

## Applying Power to the Base Unit

The EXAI918 phones require an AC outlet, without a switch to interrupt power, and the included AC adapter. To relieve strain on the DC plug when the phone is placed on a desk or table, connect the adapter as shown below.

Wrap the power cord around the convenient notch on the bottom.

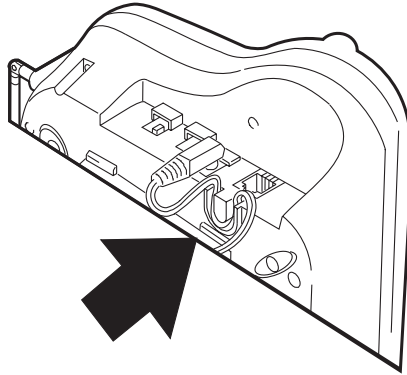

**Important:** Place the power cord so that it does not create a trip hazard, or where it could become chafed and create a fire or other electrical hazards.

## Desk or Tabletop Installation

1. Place the Base Unit on a desk or tabletop.

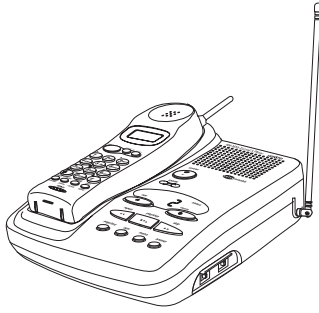

2. Plug the AC Adapter cord into the 9V DC input jack on the Base Unit.

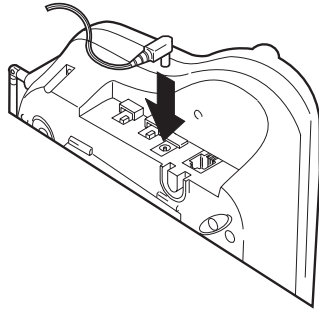

3. Place the AC Adapter cord around the strain relief.

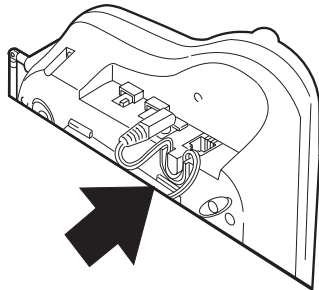

4. Plug one end of the long telephone cord into the **TEL LINE** jack on the Base Unit.

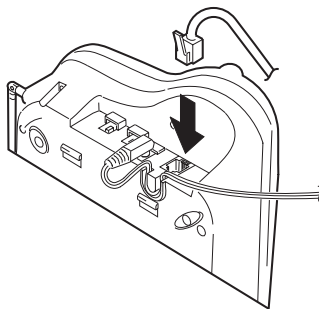

5. Plug the other end of the cord into the telephone jack on the wall.

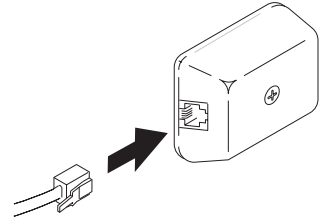

6. Plug the AC Adapter into a standard 120V AC wall outlet.

**Note:** Do not use an outlet controlled by a wall switch.

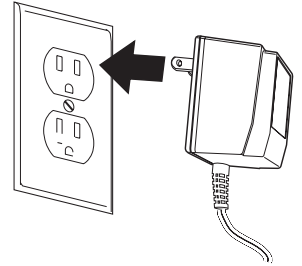

## Wall Installation

### Standard Wall Plate Mounting

These phones are designed to be mounted on a standard AT&T or GTE wall plate.

1. Plug the AC Adapter into the Base Unit.

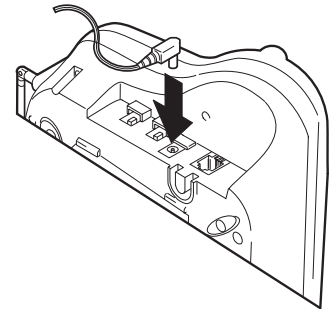

2. Place the AC Adapter cord inside the molded channel.

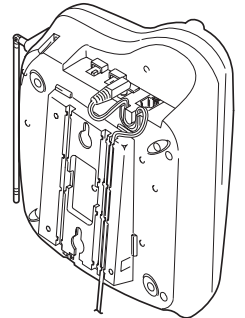

3. Plug one end of the short telephone cord into the **TEL LINE** jack on the Base Unit.

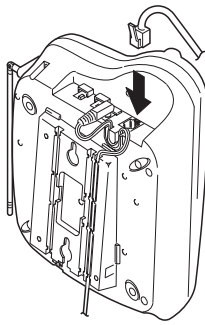

4. Place the telephone cord inside the molded channel on the bottom of the Base Unit. Then plug the other end of the telephone cord into the modular jack on the wall.

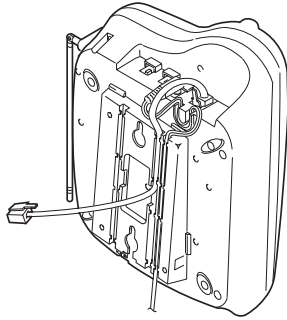

5. Place the Base Unit on the posts of the wall plate and push down until it's firmly seated.

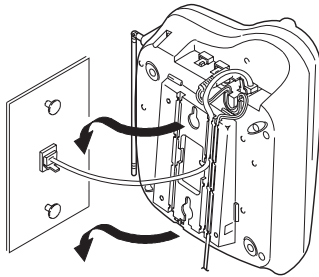

6. Plug the AC Adapter into a standard 120V AC wall outlet.

**Note:** Do not use an outlet controlled by a wall switch.

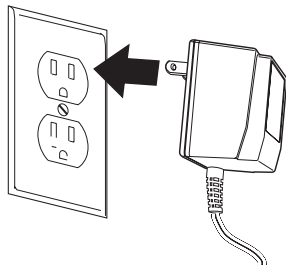

## Direct Wall Mounting

If you do not have a standard wall plate, you can mount your phone directly on a wall. Before mounting your phone, consider the following:

- Select a location away from electrical cables, pipes, or other items behind the mounting location that could cause a hazard when inserting screws into the wall.
- Make sure the wall material is capable of supporting the weight of the Base Unit and Handset.
- Use the screws supplied with anchoring devices suitable for the wall material where the Base Unit will be placed.

1. Insert two mounting screws  $3\frac{5}{16}$  inches apart. Allow about  $\frac{5}{16}$  of an inch between the wall and screw heads for mounting the phone.

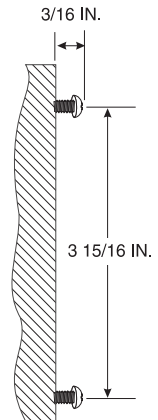

2. Plug the AC Adapter into the Base Unit.

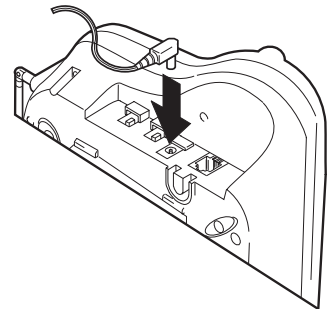

3. Place the AC Adapter cord inside the molded channel.

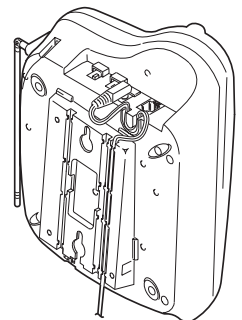

4. Plug one end of the long telephone cord into the **TEL LINE** jack on the Base Unit.

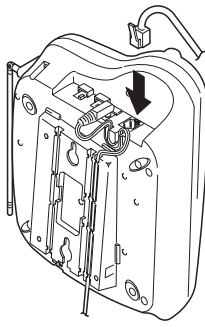

5. Place the cord inside the molded channel on the bottom of the Base Unit.

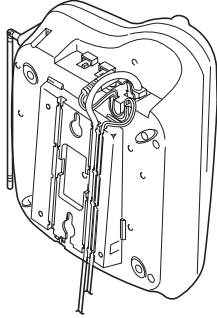

6. Place the Base Unit on the screws and push down until it's firmly seated.

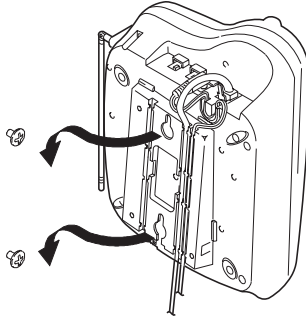

7. Plug the other end of the telephone line cord into the wall jack.

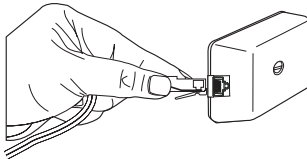

8. Plug the AC Adapter into a standard 120V AC wall outlet.  
**Note:** Do not use an outlet controlled by a wall switch.

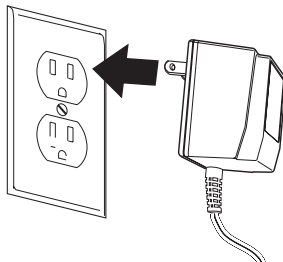

## Setting the Handset Retainer

The handset retainer holds the Handset in place if your phone is mounted on a wall. The steps below describe how to remove and replace the retainer so that the tab faces up.

1. Push up on the Handset retainer on the Base Unit, and slide the tab out.

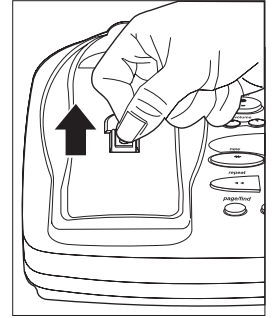

2. Flip the retainer over so the tab faces up.

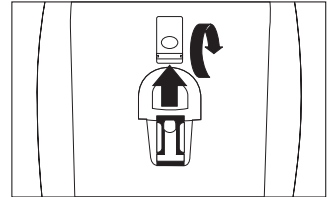

3. Put the retainer back into its slot on the Base Unit.

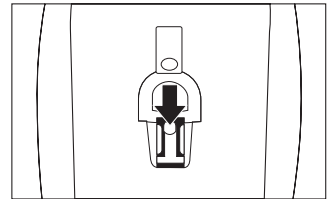

4. Push down on the Handset retainer until it snaps into place.

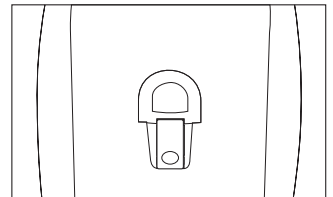



# Setting Up Your Phone

## Extending the Base Unit Antenna

Before using your phone, be sure to raise the antenna to the vertical position.

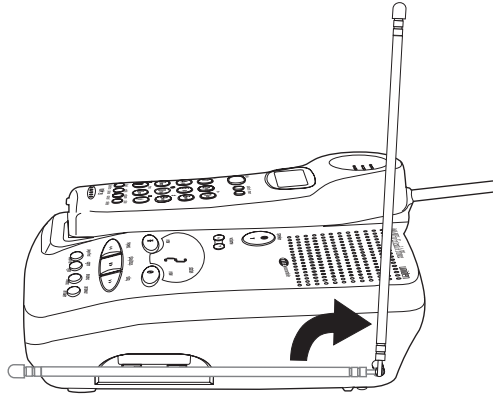

## Installing the Handset Battery Pack

1. Press in on the Battery Cover Release.

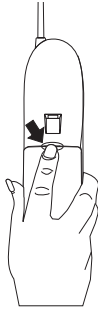

2. Slide the battery compartment cover down.



3. Align the plastic connector of the Nickel-Cadmium battery pack with its socket and plug it in.

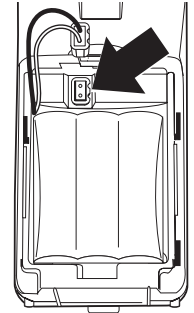

**Note:** The black lead will be on top when the plug is properly aligned.

4. Place the battery pack inside the battery compartment, and slide the battery cover back on.



**Note:** The built-in Memory Backup feature allows up to 3 minutes to disconnect the old battery pack and install a new one without losing any numbers stored in memory.

## Cleaning the Battery Contacts

To maintain a good charge, it is important to clean all charging contacts on the Handset and Base Unit about once a month. Use a pencil eraser or other contact cleaner. **Do not** use any liquids or solvents.

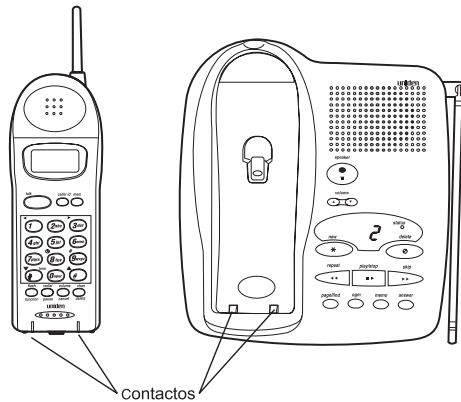

## Charging the Battery Pack

### Initial Battery Charging

The rechargeable Nickel-Cadmium battery pack must be fully charged before using your phone for the first time. We recommend that the battery pack charge for approximately 15-20 hours, without interruption, before plugging the phone line into your new phone.

1. Place the Handset on the Base Unit.

**Note:** You can place the Handset face down or face up.

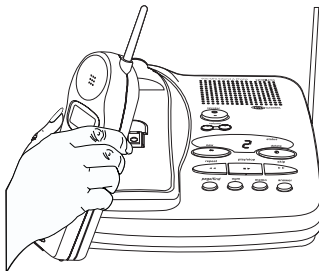

—OR—

Hang the Handset on the cradle when the phone is mounted on a wall.

**Note:** Make sure to change the Handset Retainer before hanging up the phone.

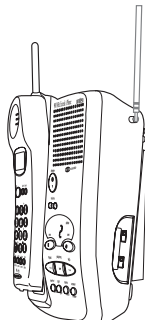

2. Make sure the Battery icon lights. If the icon doesn't light, check to see that the AC adapter is plugged in, and that the Handset is making good contact with the Base Unit charging contacts.



### Low Battery Indicator

When the Battery Pack in the Handset is very low and needs to be charged, the Battery icon flashes.



If the Battery icon begins to flash, the phone is programmed to eliminate its functions to save power. The table below describes what to do to return your phone to normal operation.

During A Call	In Standby Mode
Handset continues normal operation.	None of the buttons will operate.
The Handset beeps and the battery icon flashes once every 3 seconds.	The Handset battery icon flashes once every 3 seconds.
Complete your call as quickly as possible.	You will not be able to make a call.
Return the Handset to the Base Unit for charging.	Return the Handset to the Base Unit for charging.

**Note:** Allow 15 to 20 hours without any interruption for the Handset to fully recharge.

### Battery Memory Effect

Rechargeable batteries can develop a “memory effect.” This memory effect can reduce talk and standby time.

### To Avoid this Memory Effect

Use the phone until the “Battery Low” indicator appears. Then, charge the battery for 15 to 20 hours.

### Setting the Pulse/Tone Switch

Be sure the PULSE/TONE switch is in the TONE position.

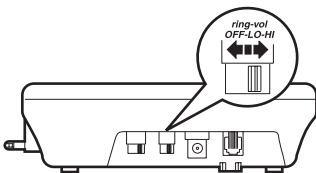

**Note:** Most phone systems are Tone dialing. Check with your local phone company if you are not sure whether your system is Tone or Pulse dialing.

## Automatic Digital Code Security

To avoid unauthorized calls on your phone, a Digital Code feature was added to all EXA1918 phones. This Digital Code is shared only between the Handset and Base Unit. The code is set *automatically* when you first use the phone.

To change or reset the Digital Code, be sure the Handset is on the Base Unit, then:

1. Press **page/find** on the Base Unit.

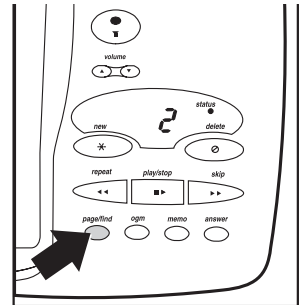

2. After the Handset stops beeping, remove it from the Base Unit.

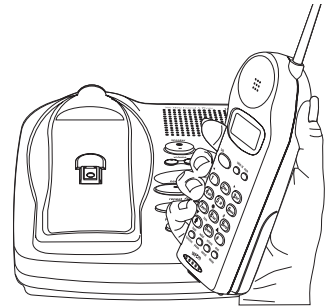

3. Wait 5 seconds then place the Handset on the Base Unit.



4. The Status icon on the Base Unit will blink to indicate that the Digital Security Code is set to one of the more than 65,000 codes.

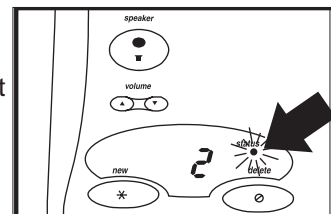

If the Base Unit loses power while the Handset is off the Base Unit, the Digital Code may be erased. When this happens, the Handset will not function. To reestablish communication between the Handset and Base Unit:

1. Restore power to the Base Unit.
2. Place the Handset back on the Base Unit.



3. The Status icon on the Base Unit will blink to indicate that the Digital Security Code is set.

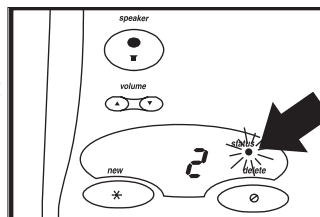

## Handset Volume Controls

Please refer to the foldout in front of your operating guide for key positions.

To adjust the ringer volume of your Handset, press **volume/cancel** until you hear the desired ringer tone and volume.

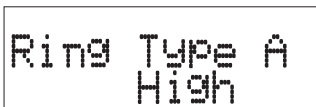

Two-tone High

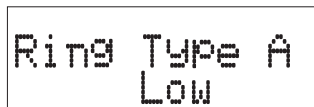

Two-tone Low

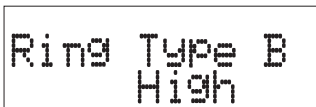

Three-tone High

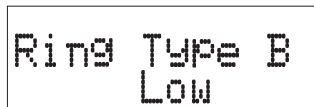

Three-tone Low

To adjust the receiver volume, press **volume/cancel** while you are on a call.

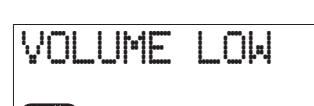
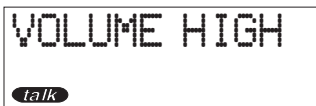

## Channel Selector Button

If the audio becomes weak or scratchy, press **chan** on the handset to select a clearer channel.

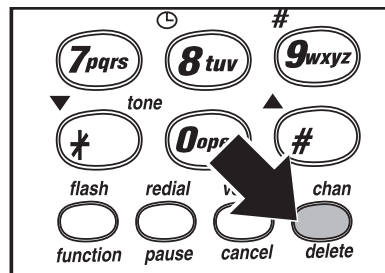

## Entering the Local Area Code

**Note:** Please refer to the foldout in front of your operating guide for key positions.

You must enter your local area code for the Caller ID redial features to work properly.

To enter your local area code:

1. Remove the Handset from the Base Unit.
2. Press **flash/function** twice.

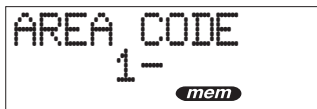

3. Enter your local area code. For example, 817.

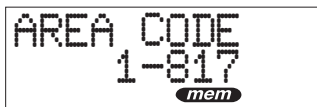

4. Press **mem**. A confirmation tone sounds and the display remains on for two seconds.



5. Place the Handset on the Base Unit. The Status LED on the Base Unit will blink to indicate that the area code is stored.

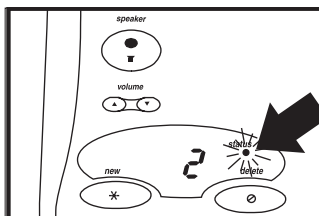

To delete your local area code:

1. Remove the Handset from the Base Unit.
2. Press **flash/function** twice.

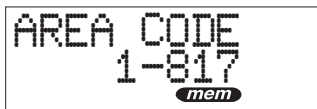

3. Press **chan/delete** three times.

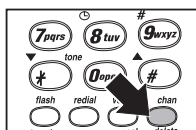

4. Press **mem**. A confirmation tone sounds and the display remains on for two seconds.



5. Place the Handset on the Base Unit. The Status LED on the Base Unit will blink to indicate that the area code is deleted.

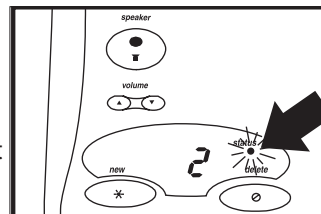

## Setting Caller ID on Call Waiting

**Note:** You must subscribe to Caller ID on Call Waiting from your local phone service to use this feature.

You can set your EXA1918 phone to display information about calls that generate a call waiting tone while you are on a call.

**Note:** With this feature set you will not be able to hear the person you are talking to for a brief period after you receive the call waiting tone.

To turn Caller ID on Call Waiting on:

1. Remove the Handset from the Base Unit.
2. Press **flash/function** three times.



3. Press 1.



4. Press **mem**. A confirmation tone sounds and the display remains on for two seconds.



5. Place the Handset on the Base Unit. The Status LED on the Base Unit will blink to indicate that Caller ID on Call Waiting is on.

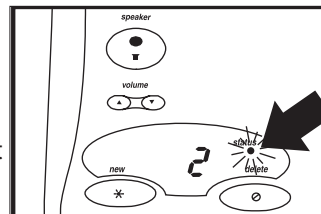

To turn Caller ID on Call Waiting off:

1. Remove the Handset from the Base Unit.
2. Press **flash/function** three times



3. Press **0**.



4. Press **mem**. A confirmation tone sounds and the display remains on for two seconds.



5. Place the Handset on the Base Unit. The Status LED on the Base Unit will blink to indicate that the Caller ID on Call Waiting is off.

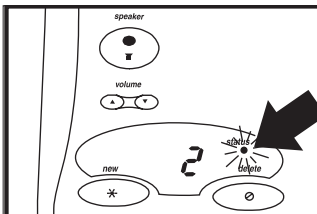

To turn AutoTalk off:

1. Remove the Handset from the Base Unit.
2. Press **flash/function** four times.



3. Press **0**.



4. Press **mem**. A confirmation tone sounds and the display remains on for two seconds.



5. Place the Handset on the Base Unit. The Status LED will blink to indicate that the setting has been stored.

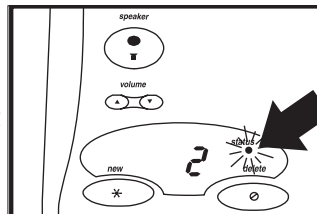

## Setting the AutoTalk Feature

To turn AutoTalk on:

1. Remove the Handset from the Base Unit.
2. Press **flash/function** four times.



3. Press **1**.



4. Press **mem**. A confirmation tone sounds and the display remains on for two seconds.



5. Place the Handset on the Base Unit. The Status LED on the Base Unit will blink to indicate that the setting has been stored.

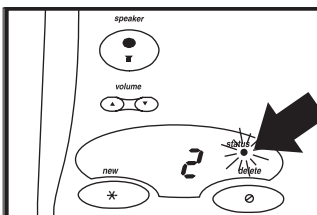

# Using Your Phone

Please refer to the foldout in front of your operating guide for key positions.

When you have connected power and a telephone line to your EXAI918, the phone is in the "standby mode," ready to receive and make calls.

## Making Calls

1. Remove the Handset from the Base Unit.

2. Dial the number you wish to call. For example, *123-4567*



3. If you entered a wrong number, press *chan/delete* to backspace until the number is erased.



To cancel making the call, press *volume/cancel*.

4. Press *talk*. The LCD displays the channel number.



**Note:** If the Handset fails to connect with the Base Unit the Handset beeps and returns to standby mode.

5. During your conversation the LCD displays the call timer.

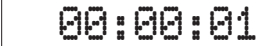

When you have finished with the conversation, press *talk* to hang up.

— OR —

Place the Handset back on the Base Unit.

## Receiving Calls

**Note:** You must subscribe to Caller ID services from your local phone company for the caller's name and number to be displayed.

When the phone rings, the LCD displays a calling screen for two rings.

If Caller ID information about the person calling is not available, this screen remains on until you answer the call.



— OR —

If the Caller ID information is received, the LCD displays:



— OR —

If the signal is invalid, the LCD displays:



— OR —

If the number of the person calling is a private number, the LCD displays:



— OR —

If the name of the person calling is a private name, the LCD displays:



— OR —

If the number of the person calling is unknown, the LCD displays:



— OR —

If the name of the person calling is unknown, the LCD displays:



UNKNOWN NAME

## Using the Speakerphone

To use the speakerphone to answer a call, press **speaker** on the Base Unit. Direct your voice to the microphone on the bottom of the Base Unit. To hang up, press **speaker** again.

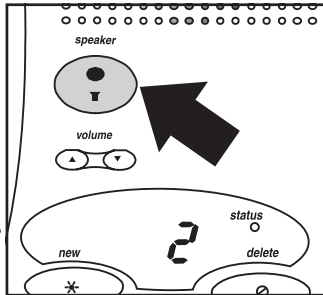

**Note:** Adjust the speakerphone volume by pressing ▲ for louder or ▼ for softer.

## Answering a Call with AutoTalk Enabled

If you have enabled the AutoTalk feature, just remove the Handset from the Base Unit to answer an incoming call. See "Setting the AutoTalk Feature" on page 18 for details on setting AutoTalk.

If the Handset is off the Base Unit, press any key to answer an incoming call.

## Answering a Call without AutoTalk Enabled

When the phone rings, pick up the Handset and press **talk**. The channel number is displayed for 2 seconds.

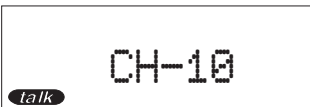

During your conversation the LCD displays the call timer.

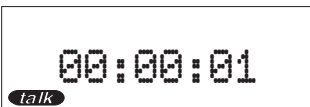

When you are finished with the conversation, press **talk** to hang up.

— OR —

Place the Handset back on the Base Unit.

## Redialing the Last Number Called

1. Remove the Handset from the Base Unit.
2. Press **talk**.

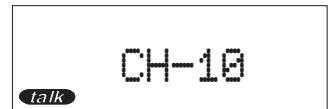

**Note:** If the Handset fails to connect with the Base Unit the Handset beeps and returns to standby mode.

3. Press **redial/pause**.



**Note:** If the last number dialed is longer than 12 digits, the display will scroll to the left until the last number is shown in the display.

4. During your conversation the LCD displays the call timer.

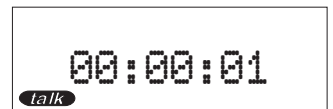

5. When you have finished with the conversation, press **talk** to hang up.

— OR —

Place the Handset back on the Base Unit.

## Using the Flash Key with Call Waiting

**Note:** You must subscribe to call waiting service from your local phone company to use this feature.

1. While talking you hear the call waiting signal.



2. Press **flash/function** to switch to that call.

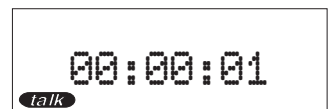

3. To switch back to your original call, press **flash/function** again.



# Using Caller ID

## The Caller ID Display

The LCD displays information about the current call and previous calls received on your EXAI918 cordless phone, including the total calls received, and the number of new calls received.

The LCD display backlight is always active while the Handset is on the Base. When the Handset is removed from the Base, the LCD display backlight turns off immediately. To reactivate the LCD backlight, you need to press *caller id*.

### LCD with Handset on Base



NO NEW CALLS

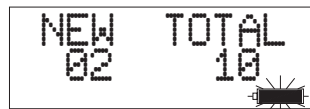

WITH NEW CALLS

### LCD with Handset off Base and Caller ID Pressed



NO NEW CALLS



WITH NEW CALLS

**Note:** The EXAI918 can store information on up to 30 different calls. Information on new calls received after 30 calls will be stored, and the oldest call in memory will be deleted.

## Viewing Calls in Memory

1. The **status** LED blinks, indicating when you have received new calls.

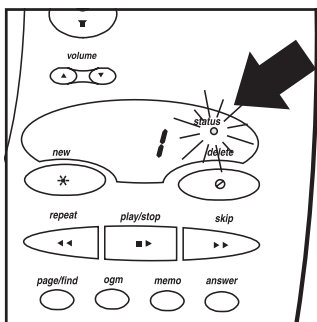

To dial the number currently displayed, press the **talk** key.

To add a **1** for long distance dialing, press **1** and then press the **talk** key.

**Note:** If the number is longer than 12 digits, the display will scroll to the left until the last number is shown in the display.

2. Remove the Handset from the Base Unit.
3. Press **caller id**.



5. To see all calls stored in memory, press the **▲** key repeatedly until the LCD displays END.



4. To view calls stored in memory, Press the **▼** or **▲** keys.



6. To see the time and day a call was received:

- a. While the name and number are displayed, press **⊙**.



- b. To return to the name and number display, press **⊙**.

6. To see how many times a caller has phoned:

- a. While the name and number are displayed, press **9/#**.



- b. To return to the name and number display, press **9/#**.

3. Press and hold **chan/delete** for at least three seconds. A double beep tone sounds to confirm the message has been deleted.

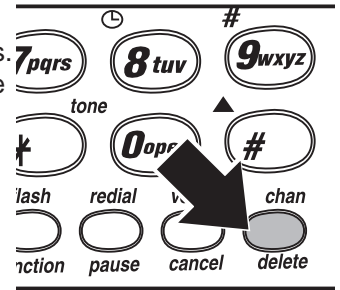

## Calling the Displayed Number

- To dial the number currently displayed, press the **talk** key.
- To add a 1 for long distance dialing, press **1** and then press the **talk** key.

## Deleting Caller ID messages

Only individual messages can be deleted on the EXAI918. To delete messages follow the steps below.

1. Press **caller id**.



2. Press ▲ or ▼ to scroll to the call you want to delete.



The next name and number is displayed.

- Repeat steps 2 and 3 to delete any other calls from the caller id memory.
- Press **caller id** when finished.

# Programming Your Phone

## Storing a Caller ID memory number in Dial Memory

There are 20 dial memory locations in the EXAI918 cordless phone.

You can store any number in your Caller ID memory in Dial Memory so it can be used later with memory dialing. See Calling a Number Stored in Memory on page 24 for details on how to use the memory dial feature.

1. Remove the Handset from the Base Unit.
2. Press *caller id*.



3. Press ▲ or ▼ until the call you want to store is displayed.



4. Press *mem*.



5. Enter the memory location, for example, 05. You hear a confirmation beep and the LCD displays:



6. Press *caller id* to return to Standby mode.

## Entering a Number in Dial Memory

There are 20 dial memory locations in the EXAI918 cordless phone.

You can manually enter any number into dial memory so that it can be dialed later.

1. Remove the Handset from the Base Unit.
2. Press *flash/function*.



3. Press 1.



4. Enter the phone number you want to store. For example, 123-4567.



5. Press *mem*.



6. Enter a name up to 12 characters long using the ▼ and ▲ keys to select characters and the ◀ or ▶ to move one character to the left or right.

For example, to enter the name Bob Jones:

Press ▼ until B is displayed in the LCD.



Press ▶ to move one character to the right.



Press ▼ until o is displayed in the LCD.



Press ▶ to move one character to the right.



Press ▼ until b is displayed in the LCD.



Continue until the name Bob Jones is displayed in the LCD.



7. Press *mem*.



8. Enter a memory location for the number. For example, press **05** to assign location 05 to the number. You hear a confirmation beep and "Storing" displays.



## Calling a Number Stored in Memory

Use this feature to dial a number previously stored in memory. See Storing a Caller ID memory number in Dial Memory on page 23 or Entering a Number in Dial Memory on page 23 for details.

1. Remove the Handset from the Base Unit.
2. Press *mem*.



3. Enter the memory location. For example, for memory location 05, press **05**.



**Note:** If you want to dial a different number stored in dial memory, use the ▲ and ▼ keys to scroll through the numbers stored in memory.

4. Press *talk* to dial the number.

## Editing and Deleting Numbers in Dial Memory

Use this feature to edit or delete numbers stored in dial memory.

1. Remove the Handset from the Base Unit.
2. Press *flash/function*.



3. Press **0**.



To delete the entry in dial memory:

Press and hold *chan/delete* for two seconds. A confirmation tone sounds and the memory location is cleared.



4. Enter the memory location to edit or delete. For example, to edit or delete location 05, press **05**.



To edit the number entry in dial memory, for example, to change **4567** to **5941**:

Press *mem*.



— OR —

Use the ▲ and ▼ keys to scroll to the memory location.



Press *chan/delete* four times.



Enter **5941**.



To edit the name entry in dial memory, for example to change Bob Jones to Tom Jones:

Press *mem* twice.



Bob Jones  
1235941  
*mem*

Press ▲ until T is displayed in the LCD.



Tob Jones  
1235941  
*mem*

Press ► twice to move two characters to the right.



Tom Jones  
1235941  
*mem*

Press ▲ until m is displayed in the LCD.



Tom Jones  
1235941  
m

Press *mem*.



STORING  
*mem*

# The Integrated Answering System

The EXAI918 has a *built-in* Answering System which answers incoming calls and records your messages. You can also use your new Answering System to record a conversation, leave a memo message for someone else who uses the phone, or to announce a special message when you'll be away from your phone.

## Features

- Digital Tapeless Recording
- Remote Telephone Operation
- Selectable Outgoing Messages
- Built in Flash Memory Backup
- Toll Saver Switch
- Approximately 20 Minute Record Time
- Call Screening
- Calling Party Control
- Time and Day Stamp
- Memo Messaging Capability

Digital Tapeless Recording allows you to quickly review your messages, saving or deleting the messages you choose. You'll never have to worry about a tape wearing out or resetting properly.

Your EXAI918 is an advanced, integrated system which offers you maximum flexibility, but ***please read*** through the sections that explain all of the features before using your Answering System.

## Answering System Setup

### Turning the Answering System On/Off

**Note:** To use the answering system for the first time, press **answer** to turn the system on.

1. To turn the Answering System on, press **answer**.

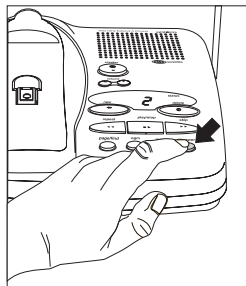

A tone sounds, and the current outgoing message plays on the Base Unit speaker. A second tone sounds to indicate the unit is ready to answer calls, and the Message Counter LED turns on.

2. To turn the Answering System off, press **answer** again.

The Message Counter LED turns off.

### Setting the Clock

The clock in your EXAI918 Answering System starts when power is applied to the Base Unit. To set the clock to the proper day and time, follow these steps.

1. Press **caller id** on the Handset.



2. Press **flash/function** on the Handset.



3. Enter the number which corresponds to the day.

Day of the Week	Press
Sunday	0
Monday	1
Tuesday	2
Wednesday	3
Thursday	4
Friday	5
Saturday	6

4. Enter the two-digit number for the hour (01-12) and the minute (00-59).

5. To set AM, press ● on the Handset.

To set PM, press ⊕ on the Handset.

- Press the **flash/function** key again.



**Note:** A beep indicates the new time is programmed and the new Time and Day Stamp is announced from the Base speaker.

- You can proceed to set your PIN Code beginning with Step 3 under “Setting the PIN Code” or press the **flash/function** key once more to return to standby.

## Setting the PIN Code

You must use your PIN code to access your Answering System from a touch-tone telephone. You can set a personal two-digit code (00-99) for your PIN code.

- Press **caller id** on the Handset.
- Press **flash/function** twice on the Handset.



**Note:** A long tone sounds when you press the **flash/function** key the second time and PIN SET appears on the screen.

- Enter the two-digit number you want to use as you PIN code.
- Press **flash/function** again.

A long tone indicates the new PIN number is programmed.

- For example, to set the time to Tuesday at 3:20 PM, and your PIN code to 00, press **caller id**, then press **flash/function** followed by these keys:



## Setting Your Outgoing Message (OGM)

When you receive a call, the Answering System answers and automatically plays either a preset message or your personal outgoing message (**ogm**).

### Preset Messages

The EXAI918 has two messages programmed in its memory. If the **rec time ANN/4/1** is set in the announce only position (**ANN**), then the first preset message below plays twice, and no incoming messages are recorded. If you select either the four minute or one minute (**4/1**) limit for incoming messages and have not recorded a personal outgoing message, then the second preset message below plays.

- “Hello. No one is available to take your call.”
- “Hello. No one is available to take your call. Please leave a message after the tone.”

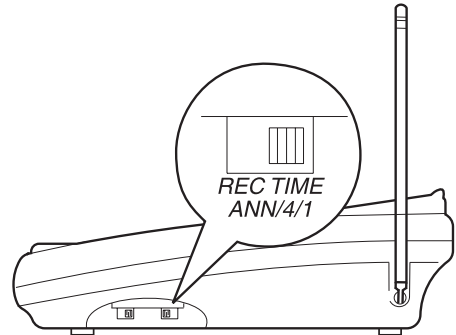

**Note:** If the **rec time ANN/4/1** switch is in the “Announce Only” position, the Message Counter LED displays an R when the system is in Standby.

### Recording Your Personal OGM

- To record an outgoing message, press and hold **ogm**.

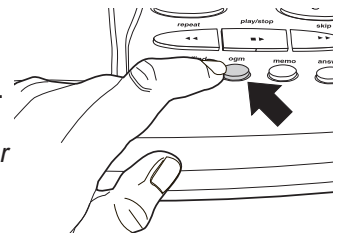

Start recording after the long tone.

- Position yourself about 12 inches away from the base and speak clearly.

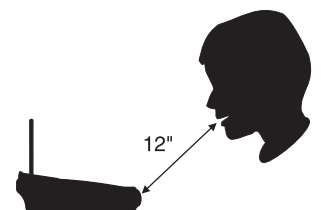

- When you have finished recording, release the **ogm** button.

*You will hear a tone, and your message will play on the Base Unit speaker.*

**Note:** You can leave up to a 60-second outgoing message.

## Selecting a Preset OGM

After you have recorded an outgoing message, you can set your Answering System to play either a preset message or your outgoing message.

- Press **ogm**.

*Your recorded outgoing message will begin to play.*

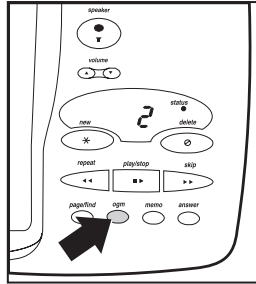

- While your recorded outgoing message is playing, press **ogm** again.

A tone will sound, and you will hear one of the preset messages. After the message plays, a tone will sound again and the Answering System automatically returns to Standby.

**Note:** The message, "Hello. No one is available to take your call" is played if the **rec time ANN/4/1** is set to announce only.

- To select your recorded message again, press **ogm**.

*The preset message will begin to play on the Base Unit speaker.*

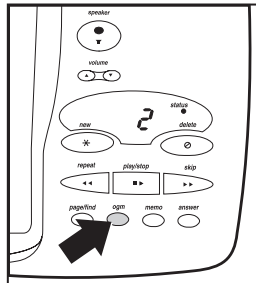

- While the preset message is playing, press **ogm** again.

A tone will sound, and your recorded message will play. When your message finishes, a tone will sound again and the Answering System automatically returns to Standby.

## Setting the Toll Saver Switch

The Ring Time/Toll Saver switch allows you to set the number of rings the caller hears before your Answering System answers. You can set the switch to answer after 2 or 4 rings. In the Toll Saver (TS) position, the Answering System answers after two rings when you have new messages recorded, and it answers after four rings if there are no new messages. So if you call long distance to check your new messages, you can hang up after the second ring and not be billed.

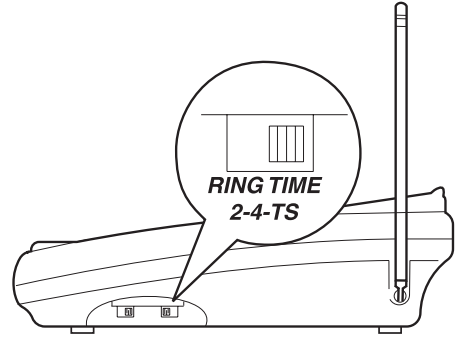

## Using the Reset Button

If you find that your telephone answering system doesn't respond when you press its keys—for example, after a power outage—you can press the reset button to return your telephone answering system to normal operation.

**Note:** Pressing reset does not erase your **PIN** (Personal Identification Number) code, **Time Stamp**, or the security code between the Handset and Base Unit.

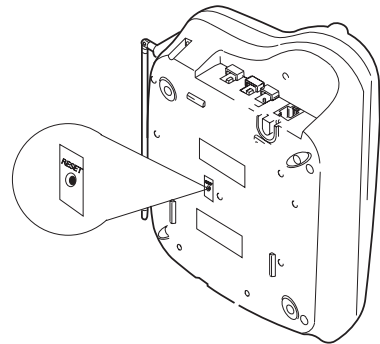

## VOX/Calling Party Control Feature

The Calling Party Control (CPC) feature allows your Answering System to disconnect and reset if the caller hangs up before leaving a message. This prevents your Answering System from using recording time to record a hang up/dial tone message.



# Using Your Answering System

## Playing New Messages

1. Press \* to listen to your new messages when the message counter is flashing.

*The time stamp is announced after each message plays, and the Message Counter LED displays the number of the message playing.*

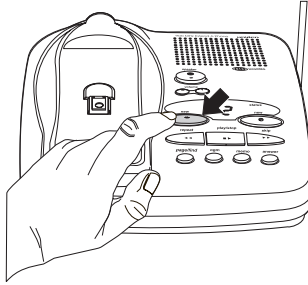

2. When all messages have played, a long tone sounds.
3. The message counter LED stops flashing, indicating that all of the new messages have been reviewed and saved as old messages.

## Playing Old Messages

1. Press ■▶.

*When you press play/stop with new messages, the unit announces how many new and old messages there then plays the messages starting with the oldest.*

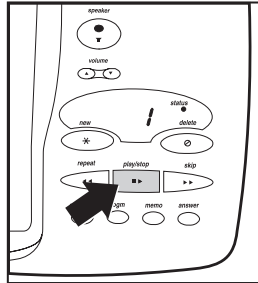

*The time and day each message was received is announced after the message is played. The Message Counter LED displays the number of the message playing.*

2. Press ■▶ again at any time to stop listening to your old messages.

## Repeating a Message

1. Press ■▶ to review your messages.

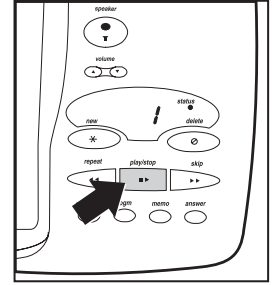

2. Press ◀◀ at anytime to replay a message.

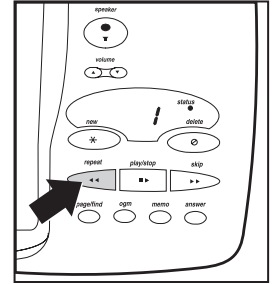

*Pressing ◀◀ during a message returns the system to the beginning of that message. Pressing ◀◀ again before the message replays causes the system to scan back one message. If you have several messages, press ◀◀ until you return to the message you want to replay.*

3. Press ■▶ at anytime to stop reviewing messages and return to Standby.

**Note:** *The system will automatically return to Standby when all the messages have played.*

## Skipping a Message

1. Press ■▶ to review your messages.

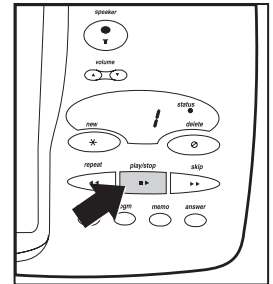

- Press **▶▶** at anytime to skip to the next message.

Each time **▶▶** is pressed, the system scans forward one message. If you have several messages, press **▶▶** until you get to the message you want to play.

- Press **■▶** at anytime to stop reviewing messages and return to Standby.

**Note:** The system automatically returns to Standby when all messages have played.

## Deleting a Message

- Press **■▶** to review your messages.

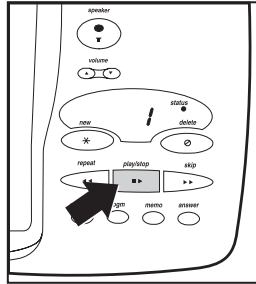

- If you decide to delete a message, press and hold **⓪** anytime during the message.

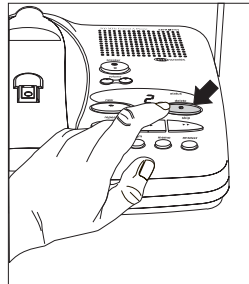

The system beeps and immediately goes to the next message.

**Note:** When you press **⓪**, you are deleting the message. Once you delete the message, it cannot be replayed.

- When all messages have played, a long tone sounds.

## Deleting All Messages

You can delete all your messages without deleting each separate message.

- Press and hold **⓪**.

**Note:** You must review all new messages before using the "Delete All Messages" feature.

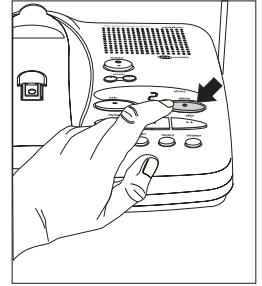

- A long tone sounds once the messages have been deleted.

**Important:** This cannot be undone, so be sure you want to delete all the messages before using the "Delete All Messages" feature.

## Message Full Indication

The EXAI918 has a maximum record time of approximately 20 minutes, or up to 40 incoming messages. When the memory is full, the Answering System will not record incoming calls. To return the system to normal operation, follow these steps.

- When the memory is full, the phone will ring 10 times before the announcement "No remaining time" plays.

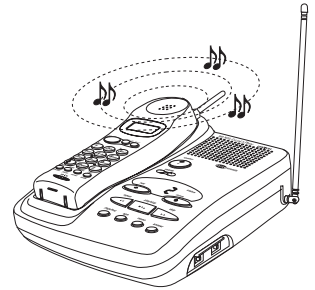

- Delete some or all of your messages.

## Leaving a Memo Message

You can use the EXAI918 to leave a Memo Message up to 60 seconds long for someone else who uses your Answering System.

To record a memo message, follow these steps:

1. Press and hold **memo**.

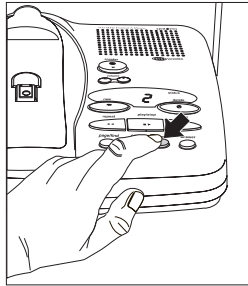

2. When the message counter begins to count up (1,2,...), speak into the microphone. When you finish speaking, release **memo**.

*There is a tone, the Message Counter begins to flash, and the system returns to standby.*

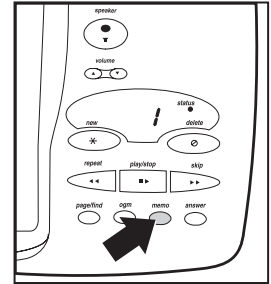

## Remote Operation

You can operate your EXAI918 while you're away from home by calling from any touch-tone phone. When using this feature, you cannot change the Time and Day Stamp or your PIN code from a touch-tone phone.

### Using a Touch-Tone Phone

You can operate your Answering System using any touch-tone telephone. Use this function to check for recorded messages, play or delete messages, or even record a new outgoing message.

1. Call your telephone number.

2. During the outgoing message playback, press **#** followed by your **PIN** number.



3. The Answering System announces the Time Stamp followed by the number of new messages stored in memory. If you have messages they are played.
4. You then hear intermittent beeps indicating that the system is in the Command Waiting Mode.

**Note:** You must enter a command within 20 seconds or the Answering System hangs up and returns to Standby.

5. Use this chart to select the function you want.

Function	Press
Repeat	[#]+[1]
Play Message	[#]+[2]
Skip	[#]+[3]
Delete Message	[#]+[4]
Answer On/Off	[#]+[5]
Stop	[#]+[6]
Record OGM/Rec Stop	[#]+[7]
Play New Message	[#]+[8]
Review OGM	[#]+[9]
Help	[#]+[0]

6. When you've finished, hang up to exit the system.

*Your Answering System automatically returns to Standby.*

# Troubleshooting

If your EXAI918 Integrated Telephone Answering Device is not performing to your expectations, please try these simple steps. If you are still unable to resolve the problems, contact Uniden Customer Service at (800) 297-1023, 8:00 a.m. to 5:00 p.m. Central, Monday through Friday.

## Telephone Troubleshooting Chart

Problem	Suggestion
Status light won't come on when Handset is placed in Base Unit.	<ul style="list-style-type: none"> <li>• Make sure AC Adapter is plugged into the Base Unit and wall outlet.</li> <li>• Make sure Handset is properly seated in Base Unit.</li> <li>• Make sure that the charging contacts on the Handset and Base Unit are clean.</li> </ul>
Audio sounds weak and/or scratchy.	<ul style="list-style-type: none"> <li>• Make sure that the Base Unit antenna is fully vertical.</li> <li>• Move the Handset and/or Base Unit to different locations and try again.</li> <li>• Press <span style="border: 1px solid black; border-radius: 50%; padding: 2px;">chan</span> to select another channel.</li> </ul>
Can't make or receive calls.	<ul style="list-style-type: none"> <li>• Check both ends of the Base Unit telephone line cord.</li> <li>• Make sure the AC Adapter is plugged into the Base Unit and wall outlet.</li> <li>• Disconnect the AC Adapter for a few minutes, and then reconnect it.</li> </ul>
Handset doesn't ring or receive a page.	<ul style="list-style-type: none"> <li>• Nickel-Cadmium battery pack may be weak. Charge the battery on the Base Unit for 15–20 hours.</li> <li>• Rotate the Base Unit antenna fully vertical.</li> <li>• The Handset may be too far away from the Base Unit.</li> <li>• Place the Base Unit away from noise sources.</li> <li>• The Digital Security Code may be erased. Set the Digital Code. (See page 15.)</li> </ul>
Base Unit doesn't ring.	<ul style="list-style-type: none"> <li>• Set the Base Ringer Switch to <i>on</i>.</li> </ul>
Status light keeps blinking.	<ul style="list-style-type: none"> <li>• Check for new Caller ID Names/Numbers</li> </ul>

## Answering System Troubleshooting Chart

Problem	Suggestion
Answering System does not work.	<ul style="list-style-type: none"><li>• Make sure that the Base Unit is plugged in.</li><li>• Make sure the Answering System is turned on.</li><li>• Press the <b>reset</b> button to reset the system after an AC line spike.</li></ul>
Answering System does not answer calls.	<ul style="list-style-type: none"><li>• Set the <b>rec time ANN/4/1</b> switch in either the 4-minute or 1-minute position.</li><li>• The memory may be full. Delete some or all of the saved messages.</li></ul>
Messages are incomplete.	<ul style="list-style-type: none"><li>• The incoming messages may be too long. Remind callers to leave a brief message.</li><li>• The memory may be full. Delete some or all of the saved messages.</li></ul>
No sound on the Base Unit speaker during call monitoring or message playback.	<ul style="list-style-type: none"><li>• Adjust the volume control on the Base Unit.</li></ul>
Cannot access remote call-in features from another touch-tone phone.	<ul style="list-style-type: none"><li>• Make sure you're using the correct <b>PIN</b> number.</li><li>• Use a phone which can transmit tones for up to two seconds, or use another touch-tone phone to access the remote call-in features on your EXAI918.</li></ul>

# Specifications

---

**General** – The EXAI918 complies with FCC Rules, Parts 15 and 68.

Frequency Control	Phase Locked Loop (PLL) Synthesizer
Modulation	FM
Operating Temperature	– 10° to 50° C

## Base Unit

Transmit Frequency	925.999 to 927.952 MHz (40 Channels)
Power Requirements	9V 350 mA (from AC adapter)
Size	7 3/4 in. (H) x 7 in. (W) x 2 in. (D)
Weight	Approx. 20 oz.

## Handset

Transmit Frequency	902.078 to 904.030 MHz (40 Channels)
Power Requirements	Rechargeable Ni-Cd Battery Pack
Size	6 3/4 in. (H) x 2 1/8 in. (W) x 1 1/2 in. (D) (w/o antenna)
Weight	Approx. 11.7 oz. (including battery)
Battery	Capacity           600mAh 3.6V
	Talk Mode           7 hours
	Standby Mode       14 days

## Answering System

Memory Type	Digital Tapeless Recording
Memory Capacity	approx. 20 min. (40 messages)
Message Length	1 min. or 4 min. incoming message (max.) 60 sec. outgoing message (max.)

*Specifications, Features, and availability of Optional Accessories are all subject to change without prior notice.*

# One Year Limited Warranty

Important: Evidence of original purchase is required for warranty service.

**WARRANTOR:** UNIDEN AMERICA CORPORATION ("Uniden")

**ELEMENTS OF WARRANTY:** Uniden warrants, for one year, to the original retail owner, this Uniden Product to be free from defects in materials and craftsmanship with only the limitations or exclusions set out below.

**WARRANTY DURATION:** This warranty to the original user shall terminate and be of no further effect 12 months after the date of original retail sale. The warranty is invalid if the Product is (A) damaged or not maintained as reasonable or necessary, (B) modified, altered, or used as part of any conversion kits, subassemblies, or any configurations not sold by Uniden, (C) improperly installed, (D) serviced or repaired by someone other than an authorized Uniden service center for a defect or malfunction covered by this warranty, (E) used in any conjunction with equipment or parts or as part of any system not manufactured by Uniden, or (F) installed or programmed by anyone other than as detailed by the Operating Guide for this product.

**STATEMENT OF REMEDY:** In the event that the product does not conform to this warranty at any time while this warranty is in effect, warrantor will either, at its option, repair or replace the defective unit and return it to you without charge for parts, service, or any other cost (except shipping and handling) incurred by warrantor or its representatives in connection with the performance of this warranty. Warrantor, at its option, may replace the unit with a new or refurbished unit. **THE LIMITED WARRANTY SET FORTH ABOVE IS THE SOLE AND ENTIRE WARRANTY PERTAINING TO THE PRODUCT AND IS IN LIEU OF AND EXCLUDES ALL OTHER WARRANTIES OF ANY NATURE WHATSOEVER, WHETHER EXPRESS, IMPLIED OR ARISING BY OPERATION OF LAW, INCLUDING, BUT NOT LIMITED TO ANY IMPLIED WARRANTIES OF MERCHANTABILITY OR FITNESS FOR A PARTICULAR PURPOSE. THIS WARRANTY DOES NOT COVER OR PROVIDE FOR THE REIMBURSEMENT OR PAYMENT OF INCIDENTAL OR CONSEQUENTIAL DAMAGES.** Some states do not allow this exclusion or limitation of incidental or consequential damages so the above limitation or exclusion may not apply to you.

**LEGAL REMEDIES:** This warranty gives you specific legal rights, and you may also have other rights which vary from state to state. This warranty is void outside the United States of America.

**PROCEDURE FOR OBTAINING PERFORMANCE OF WARRANTY:** If, after following the instructions in this Operating Guide you are certain that the Product is defective, pack the Product carefully (preferably in its original packaging). The Product should include all parts and accessories originally packaged with the unit. Include evidence of original purchase and a note describing the defect that has caused you to return it. The Product should be shipped freight prepaid, by traceable means, to warrantor at:

Uniden America Corporation  
Parts and Service Division  
4700 Amon Carter Boulevard  
Fort Worth, TX 76155  
(800) 297-1023, 8 AM to 5 PM Central, Monday through Friday

Covered under one or more of the following patents:

4,511,761 4,523,058 4,595,795 4,797,916

5,426,690 5,650,790 5,660,269 5,661,780 5 768 345

**Uniden®**

©1999 Uniden America Corporation. All rights reserved.  
Printed in the USA.

OMEXAI9182299



## Recording your Outgoing Message

To ensure the clearest recording for your personal outgoing message, please speak within 6 inches of the base unit's microphone.

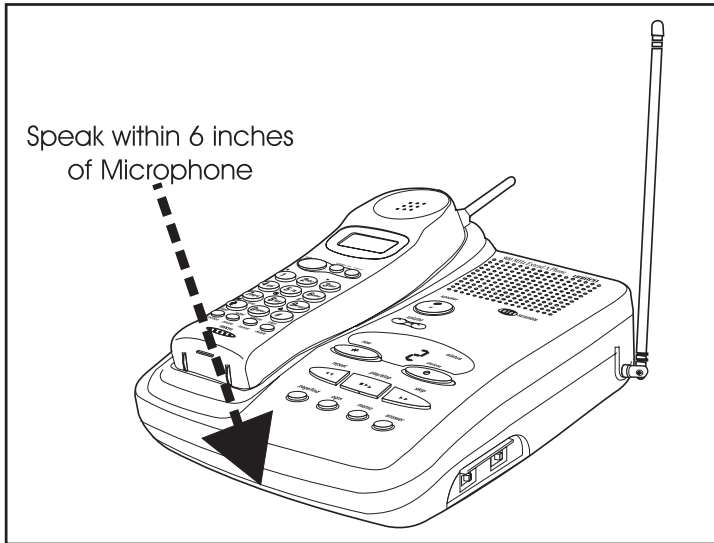

© February 1999, Uniden America Corp.

## EXA1918 Addendum

### Recording your Outgoing Message

To ensure the clearest recording for your personal outgoing message, please speak within 6 inches of the base unit's microphone.

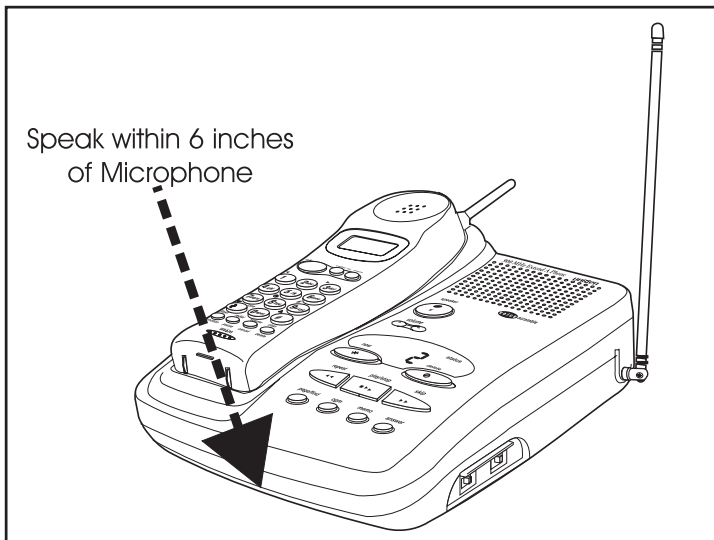

## Free Manuals Download Website

<http://myh66.com>

<http://usermanuals.us>

<http://www.somanuals.com>

<http://www.4manuals.cc>

<http://www.manual-lib.com>

<http://www.404manual.com>

<http://www.luxmanual.com>

<http://aubethermostatmanual.com>

Golf course search by state

<http://golfingnear.com>

Email search by domain

<http://emailbydomain.com>

Auto manuals search

<http://auto.somanuals.com>

TV manuals search

<http://tv.somanuals.com>