

Uniden



† To activate the Caller ID features, you must subscribe through your telephone company.

900 MHz CORDLESS

*with digital answering system
caller id/call waiting[†]
owner's manual*



**EXAI2980
Series**



Welcome

Congratulations on your purchase of the Uniden EXAI2980 series cordless telephone and answering system. This phone is designed and engineered to exacting standards for reliability, long life, and outstanding performance.

Note: Some illustrations in this manual may differ from the actual unit for explanation purpose.

Features

- 900 MHz Extended Range Technology
- 16 Digit, 3-line Backlit Display
- Integrated Telephone Answering Device (ITAD)
- Voice Prompted Guidance through ITAD Setup Menu
- 10 Number Memory Dialing
- Caller ID and Call Waiting Caller ID
- 30 Number Caller ID Memory
- 32 Digit Redial
- Bilingual Language Option
- Flash and Pause
- Pulse/Tone Dialing
- Page/Find
- 7 Hour Talk Time/14 Day Standby Time
- Handset Earpiece and Ringer Volume Control
- Hearing Aid Compatible
- 40 Channel Autoscan

The EXAI2980 series features include **AutoTalk™** and **AutoStandby™**. AutoTalk allows you to answer a call by just removing the handset from the base so you don't have to waste time pushing buttons or flipping switches. AutoStandby allows you to hang up by simply returning the handset to the base.

The **UltraClear Plus™** true compander circuitry virtually eliminates background noise. This innovative technology, together with 40 different channels, provides you with the best possible reception during all your conversations.

To protect you against misbilled calls which might result from your phone being activated by other equipment, the EXAI2980 series has **Random Code™** digital security which automatically selects one of over 65,000 digital security codes for the handset and base. Also, the **AutoSecure™** feature electronically locks your phone when the handset is in the base.

Be sure to visit our web site: www.uniden.com

Uniden® is a registered trademark of Uniden America Corporation.
AutoTalk, AutoStandby, UltraClear Plus, Random Code, and AutoSecure are trademarks of Uniden America Corporation.

Contents

Welcome/Features			
Controls and Functions	2, 3		
Getting Started			
Read this First	4		
Checking the Package Contents	4		
Setting up the Phone	5		
Mounting the Base Unit on a Wall	9		
Setting Caller ID Options/Language	10		
Entering Your Area Code	10		
Basics			
Making and Receiving Calls	11		
Terminology	12		
Adjusting the Handset Ringer and Earpiece Volume	12		
Redial	12		
Tone Dialing Switch-over	12		
Traveling Out-of-Range	13		
Selecting a Different Channel	13		
Page	13		
Flash and Call Waiting	13		
Memory Dialing			
Storing Phone Numbers and Names	14		
Steps for Entering Names and Special Characters	15		
Making Calls with Memory Dialing	16		
Chain Dialing	17		
Editing a Stored Name and/or Phone Number	17		
Erasing a Stored Name and Phone Number	18		
Caller ID Features			
Caller ID		19	
When the Telephone Rings		19	
Viewing the Caller ID Message List		20	
Deleting Information from the Caller ID List		20	
Using the Caller ID List		21	
The Integrated Answering Device			
Features		23	
Turning the Answering System On/Off		23	
Setting Up Your Answering System		24	
Using Your Answering System		28	
Additional Information			
Changing the Digital Security Code		32	
Installing the Beltclip		32	
Headset Installation		32	
Note on Power Sources		33	
Maintenance		33	
General Information		33	
Troubleshooting		34	
Index		36	

Controls and Functions

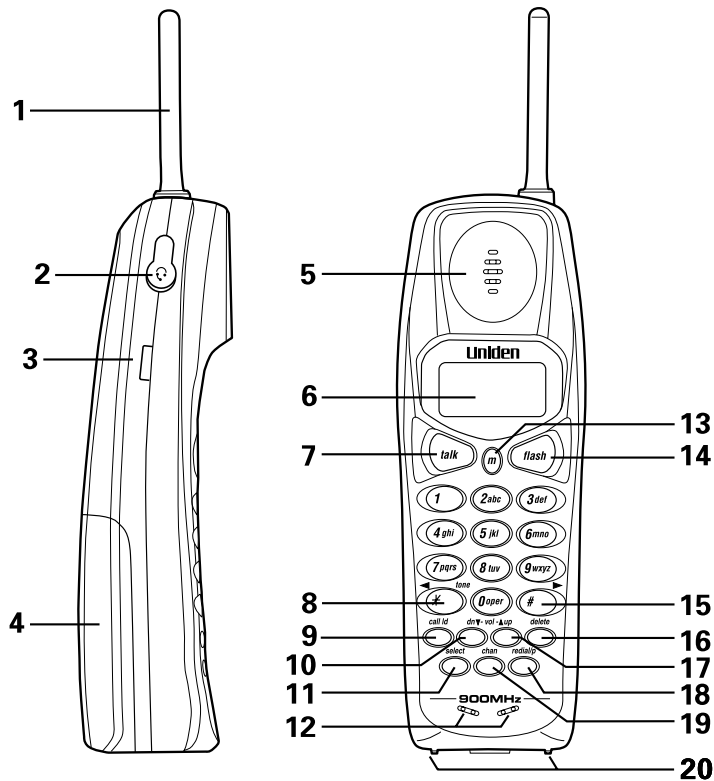

1. Handset antenna
2. Optional headset jack
3. Beltclip holes
4. Handset battery compartment
5. Handset earpiece
6. LCD display
7. Talk key
8. */left cursor (◀)/tone key
9. Caller ID key
10. Volume down key (▼)
11. Select key
12. Handset microphone and ringer speaker
13. Memory (m) key
14. Flash key
15. #/right cursor (▶) key
16. Delete key
17. Volume up key (▲)
18. Redial/pause (p) key
19. Channel (chan) key
20. Handset charging contacts

[2] CONTROLS AND FUNCTIONS

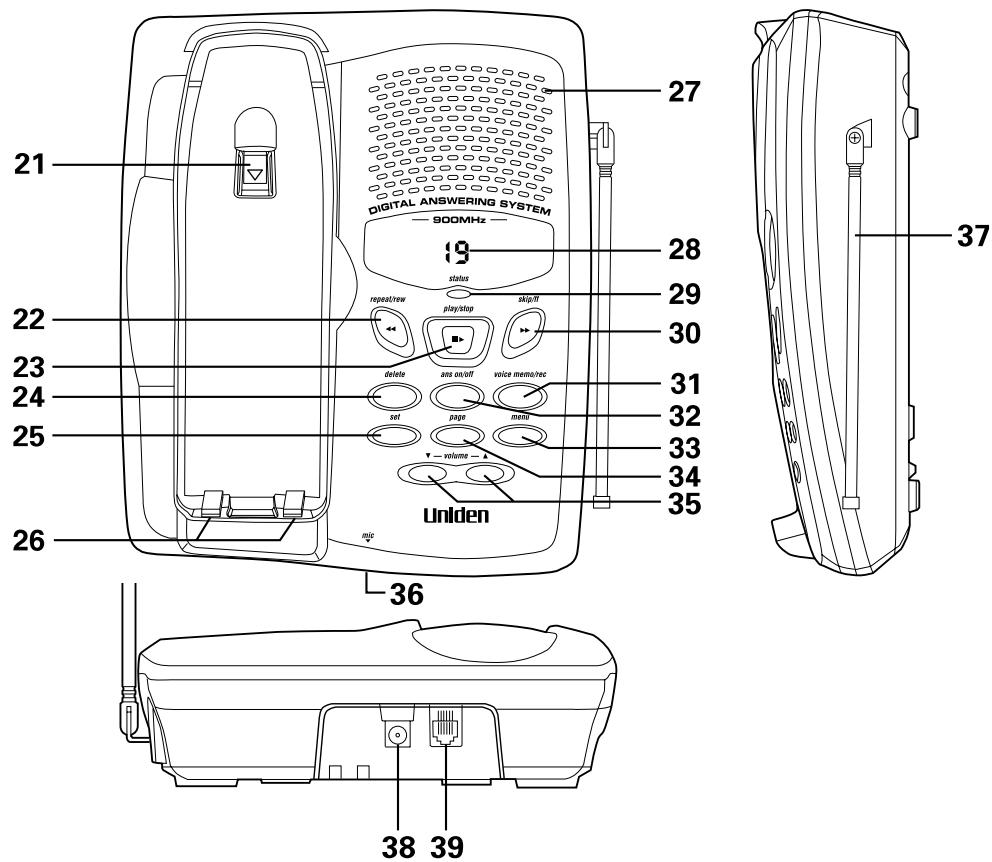

- 21. Handset retainer clip
- 22. Repeat/rewind (rew) key
- 23. Play/stop key
- 24. Delete key
- 25. Set key
- 26. Base charging contacts
- 27. Base speaker
- 28. Message counter display
- 29. Status LED
- 30. Skip/fast forward (ff) key
- 31. Voice memo/record (rec) key
- 32. Answer on/off key
- 33. Menu key
- 34. Page key
- 35. Speaker volume keys
- 36. Microphone
- 37. Base antenna
- 38. DC IN 9V jack
- 39. Telephone line jack

CONTROLS AND FUNCTIONS [3]

Read this First

This cordless telephone must be set up before use. Follow these steps:

Step 1

Unpack the telephone and accessories.

Step 2 (page 5)

Next, choose the best location to set up the base unit.

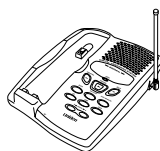

Step 3 (page 6 to 8)

Then, insert the battery pack into the handset. Connect the base unit. You must charge the battery pack for **15-20 hours before plugging into telephone line and using the phone.**

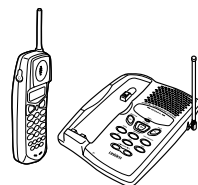

Step 4 (page 10)

Finally, set the Caller ID options and store your area code in the memory to use the Caller ID service.

Note: Skip the area code setting if your calling area requires 10-digit dialing.



Checking the Package Contents

Make sure you have received the following items in the package. If any of these items are missing or damaged, contact the Uniden Parts Department.



• Base unit



• Handset

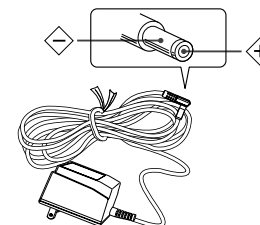

• AC adapter

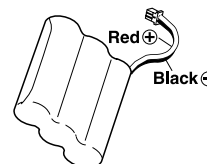

• Rechargeable battery

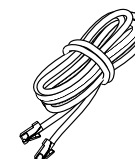

• Telephone cord

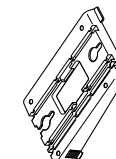

• Wall Mount Adapter

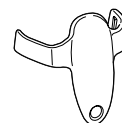

• Belt clip

Also included:

- This Owner's Manual
- Quick Reference Guide
- Precautions and Important Safety Instructions /Warranty Information
- Other printed Material

Uniden Parts Department at (800) 554-3988
Hours: M-F 7:00 a.m. to 5:00 p.m. CST. We can also be reached on the web at www.uniden.com

Setting up the Phone

Do the following steps:

- | | |
|-----------------------------|--------------------------|
| A. Choose the best location | C. Connect the base unit |
| B. Install the battery pack | D. Choose the dial mode |

A. Choose the best location

Before choosing a location for your new phone, read the **INSTALLATION CONSIDERATIONS** included in the **PRECAUTIONS AND IMPORTANT SAFETY INSTRUCTIONS** brochure. Here are some important guidelines you should consider:

Avoid heat sources, such as radiators, air ducts, and sunlight

Avoid television sets and other electronic equipment

Choose a central location

Avoid noise sources such as a window by a street with heavy traffic

Avoid microwave ovens

Avoid excessive moisture, extremely low temperatures, dust, mechanical vibration, or shock

Avoid personal computers

Avoid other cordless telephones

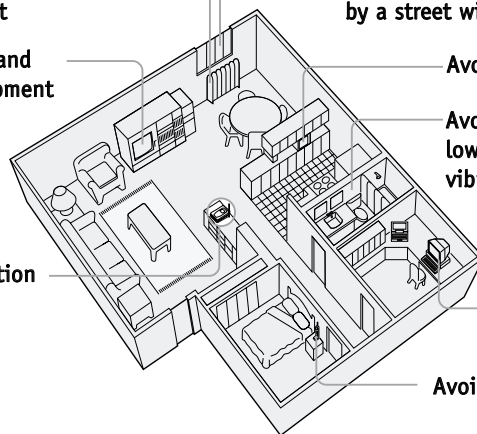

- The location should be close to both a phone jack and a continuous power outlet which is not switchable.
- Keep the base and handset away from sources of electrical noise such as motors, microwave ovens, and fluorescent lighting.
- Be sure there is sufficient space to raise the base antenna to a vertical position.
- The base can be placed on a desk, tabletop, or mounted on a standard wall plate.

About the digital security code

This cordless telephone uses a digital security code to prevent unauthorized access to your base unit. This security code prevents other cordless handsets from making calls through your base unit. A random security code will be assigned automatically between your base unit and handset when you charge the battery pack for the first time. If you want to reset the security code, see page 32.



- Use only the Uniden battery (BT-905) supplied with your phone. Replacement batteries are also available through the Uniden Parts Department (see page 4).
- Even when the battery pack is not being used, it will gradually discharge over a long period of time. For optimum performance, be sure to return the handset to the base unit after each telephone call for charging the battery.
- If you must replace the battery pack during a telephone call, complete the replacement within 30 seconds, and you may return to the caller.

B. Install the battery pack

Charge the battery pack for at least 15-20 hours before plugging the telephone jack and start using your phone.

- 1) Press in on the battery cover release and slide the cover down until it comes off.
- 2) Connect the battery pack connector observing correct polarity (black and red wires) to the jack inside the battery compartment.

Do not exert any force on this connection. It could cause damage to the battery or handset. Once you are certain that you have made a good connection, then insert the battery pack into the battery compartment. Do not pinch the wires.

- 3) Securely close the battery compartment cover by sliding it up until it snaps into place.
- 4) Place the handset on the base. Remove the beltclip, if attached, for face up charging.

Battery use time (per charge)

From fully charged

- Seven hours continuous use.
- Fourteen days when the handset is in the standby mode.

Low battery alert

When the battery pack is very low and needs to be charged, the phone is programmed to eliminate functions in order to save power. If the phone is not in use, "Low Battery" appears on the LCD and none of the keys will operate.

If the phone is in use, "Low Battery" flashes and the handset beeps. Complete your conversation as quickly as possible and return the handset to the base unit for charging.



The last number dialed in the redial memory and the numbers stored in the memory locations are retained for up to 30 minutes while you replace the battery pack.

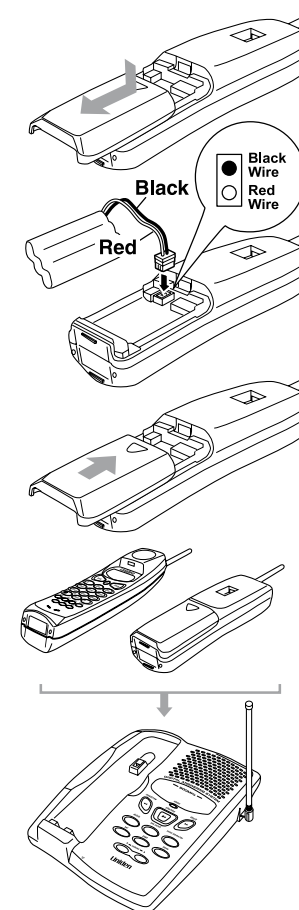

Low Battery

Cleaning the battery charging contacts

To maintain a good charge, it is important to clean the battery contacts on the handset and base unit with a dry cloth or a pencil eraser about once a month. Do not use any liquids or solvents.

C. Connect the base unit

- 1) Connect the AC adapter to the **DC IN 9V** jack and a standard 120V AC wall outlet.
- 2) Set the base on a desk or tabletop, and place the handset on the base unit as shown. Remove the beltclip, if attached for face up charging. (For wall mounting, see "Mounting the Base Unit on a Wall", on page 9.)
- 3) Raise the antenna to a vertical position.
- 4) Make sure the **status** LED lights. If the LED does not light, check to see that the AC adapter is plugged in and the handset makes good contact with the base charging contacts.



- Use only the supplied AD-420 AC adapter. Do not use any other AC adapter.
 - Connect the AC adapter to a continuous power supply.
 - Place the base unit close to the AC outlet so that you can unplug the AC adapter easily.
- After installing the battery pack in the handset, charge your handset at least **15-20 hours before plugging into the phone line**. Once the handset battery pack is fully charged, connect the telephone line cord to the base and telephone wall outlet.

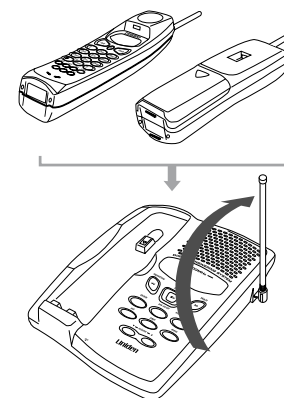
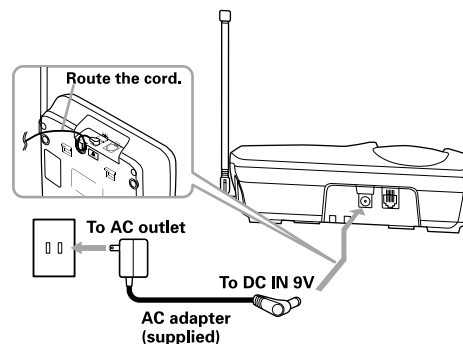
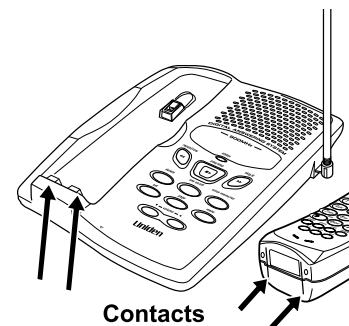

GETTING STARTED [7]

5) Connect the telephone line cord to the **TEL LINE** jack and a telephone outlet once the handset is fully charged.

tip If your telephone outlet isn't modular, contact your telephone company for assistance.

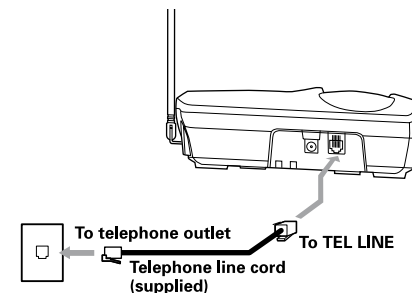
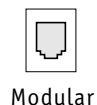

Make sure your battery pack is fully charged before choosing the dial mode.

D. Choose the dial mode

Most phone systems use tone dialing which sends DTMF tones through the phone line. However some phone systems still use pulse dialing such as in rural areas. The default setting is tone dialing. Depending on your dialing system, set the mode as follows:

- 1) Press and hold **flash** until you hear a confirmation tone.
The current setting appears next to Dial Mode.
- 2) To set the dial mode for pulse dialing, press **#▶**. Or to set the dial mode for tone dialing, press ***/tone◀**.
A confirmation tone sounds to indicate the setting is complete.

```
Dial Mode:Tone
Tone - Press *
Pulse - Press #
```

- If you are not sure of your dialing system, set for tone dialing. Make a trial call.
If the call connects, leave the setting as is, otherwise set for pulse dialing.
- If your phone system requires pulse dialing and you need to send DTMF tones for certain situations during a call, you may "switch-over" to tone dialing. (Refer to "Tone Dialing Switch-over" on page 12.)

Mounting the Base Unit on a Wall

Setting the handset retainer clip for wall mounting

- 1) On the base unit, pull the handset retainer clip out of the slot and rotate it clockwise 180 degrees.
- 2) Flip the retainer clip from front to back. Slide it back into the slot so that the lip of the retainer is up and the ▼ is down. The retainer holds the handset in place.

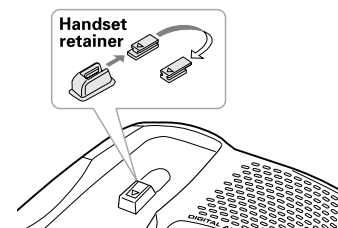

Standard wall plate mounting

This phone can be mounted on any standard wall plate.

- 1) Snap the wall mount adapter into the notches on the base.
- 2) Plug the AC adapter to the DC IN 9V jack.
- 3) Wrap the AC adapter cord inside the molded wiring channel as shown.
- 4) Plug the AC adapter into a standard 120V AC wall outlet.
- 5) Place the handset on the base and charge for 15-20 hours.
- 6) Plug the telephone line cord into the TEL LINE jack. Wrap the cord inside the molded wiring channel as shown.
- 7) Plug the telephone line cord into the telephone outlet.
- 8) Raise the antenna to a vertical position.
- 9) Align the mounting slots on the base with the mounting posts on the wall. Then push in and down until the phone is firmly seated.

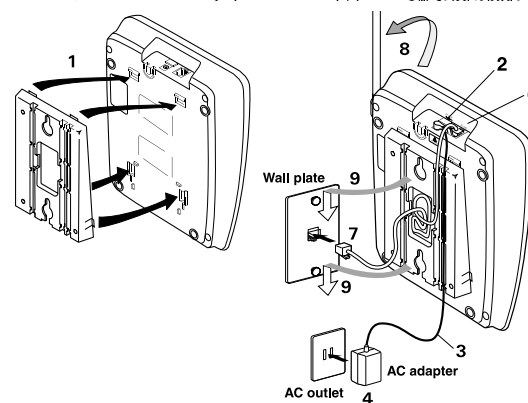

Direct wall mounting

If you don't have a standard wall plate, you can mount your phone directly to the wall. Before doing this, consider the following:

- Avoid electrical cables, pipes, or other items behind the mounting location that could cause a hazard when inserting screws into the wall.
- Try to mount your phone within 5 feet of a working phone jack to avoid excessive cord lengths.
- Make sure the wall material is capable of supporting the weight of the base and handset.
- Use #10 screws (minimum length of 1-3/8 inches) with anchoring devices suitable for the wall material where the base unit will be placed.

- 1) Insert two mounting screws into the wall, (with their appropriate anchoring device), 3-15/16 inches apart. Allow about 1/8 of an inch between the wall and screw heads for mounting the phone.
- 2) Set the retainer clip if necessary.
- 3) Refer to steps 1 through 9 above to mount the telephone.

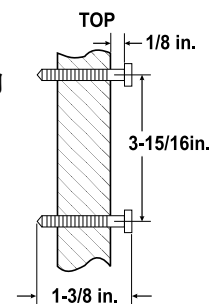

DO NOT use an outlet controlled by a wall switch.



If you have wall mounted the base, you have to remove the beltclip to hang the handset with the display facing forward.

GETTING STARTED

GETTING STARTED [9]

Setting Caller ID Options/Language

There are three Caller ID setup options available. They are AutoTalk, CIDCW (Caller ID on Call Waiting), and Area Code.

AutoTalk allows you to answer the phone without pressing the **talk** button. If the phone rings when AutoTalk is on, simply remove the handset from the base and the phone automatically answers the call. Or if the handset is not on the base, press any key to answer the call. If the phone rings when AutoTalk is off, you must press **talk** to answer the call.

Language option can be used to choose the language of your display. You can select either English or French.

To change your Caller ID options/Language:

- 1) Press and hold **call id**. The following screen appears.
- 2) Use ▲ and ▼ or a number key (1-4) to move the pointer to the selection that you would like to change.
Press **select** to toggle between "On" and "Off" for AutoTalk and CIDCW.
- 3) To set up the language of your display, press ▼ or the number key 4 to move the pointer to "Language".
Press **select** to select "Eng"(English) or "Fr"(French).
- 4) After you have made your Caller ID selections, press **call id** and return the handset to the base.

```
1 Auto Talk:Off
2 CIDCW      :On
3 Area Code:
```

note

If your calling area requires 10-digit dialing, do not program this option.

Entering Your Area Code

If you enter a 3-digit area code number in the Area Code option, your local area code does not appear in Caller ID messages. Do not program this option, if your calling area requires 10-digit dialing. When reviewing Caller ID messages, you will see only the local seven digit number. For calls received from outside your local area code, you will see a full 10-digit number.

- 1) When the phone is in the standby mode, press and hold **call id**.
The Caller ID setting screen appears.
- 2) Press **3** to select "Area Code" or press ▼ twice.
- 3) Press **select**.
- 4) Use the number keys (**0** to **9**) to enter the 3-digit area code.
- 5) Press **select**. A tone sounds and the displayed area code is entered.

```
1 Auto Talk:Off
2 CIDCW      :On
3 Area Code:
```

```
1 Auto Talk:Off
2 CIDCW      :On
3 Area Code:
```

```
1 Auto Talk:Off
2 CIDCW      :On
3 Area Code: 1
```

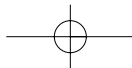



6) Press **call id** to complete the setting. Or return the handset to the base unit to complete the setting. The handset returns to the standby mode.

note When the area code has already been stored in memory, the stored area code will be displayed. To change it, use the **delete** and number keys to enter the new area code. Then press **select**. A confirmation tone sounds. To complete the setting, press **call id** or return the handset to the base unit.

```
1 Auto Talk:Off
2 CIDCW :On
3 Area Code:817
```

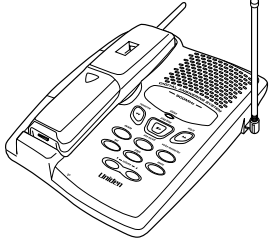
Making and Receiving Calls

	Handset On Base 	Handset Off Base 
To answer a call	Pick up the handset (AutoTalk) or press talk .	Press any key (When the AutoTalk is set to on) or press talk .
To make a call	1) Pick up the handset. 2) Press talk . 3) Listen for the dial tone. 4) Dial the number. OR 1) Pick up the handset. 2) Dial the number, then press talk .	1) Press talk . 2) Listen for the dial tone. 3) Dial the number. OR Dial the number, then press talk .
To hang up	Press talk or return the handset to the base (AutoStandby).	
To redial	1) Pick up the handset. 2) Press talk . 3) Listen for the dial tone. 4) Press redial/p .	1) Press talk . 2) Listen for the dial tone. 3) Press redial/p .



Refer to page 10 "Setting Caller ID Options" to turn on the AutoTalk feature if desired.

Terminology

Throughout this manual, terms such as Standby and Talk Mode are used. Below is the terminology explanation.

- **Standby Mode** - The handset is not in use, off the base and **talk** has not been pressed. A dial tone is not present.
- **Talk Mode** - The handset is off the base and **talk** has been pressed enabling a dial tone.

Adjusting the Handset Ringer and Earpiece Volume

Ringer tone and volume

When the phone is in standby mode, pressing the **vol ▲** or **▼** key on the handset selects the handset ringer volume and tone. There are two ringer tones each with two volume levels. Continue pressing the volume keys to listen to all tones and volume levels. The phone keeps the last ringer tone and volume setting selected.

Earpiece volume

The handset earpiece volume settings (Low, Medium, High and Maximum) can only be adjusted during a call. (Talk Mode) Press **vol ▲** or **▼** repeatedly to select Low, Medium, High, or Maximum. When you hang up, the phone keeps the last volume setting selected.

As you increase or decrease the volume, your selection appears on the display.

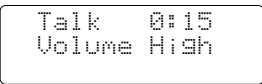

Talk 0:15
Volume High

note

The tone feature only applies when the dial mode is set to pulse.

Redial

The **redial/p** key redials the last number dialed. The redialed number can be up to 32 digits long.

Tone Dialing Switch-over

Some telephone companies use equipment that require pulse dialing (sometimes referred to as rotary dialing). If you need to enter tone dialing digits, you can switch-over to tone dialing during the call. An example of this could be entering your bank account number after you have called your bank. The digits of your bank account can be entered using DTMF tones.

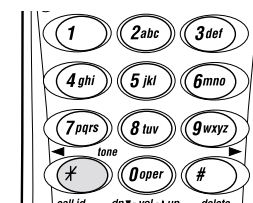

Initially make your call with the pulse dialing mode. Once your call connects, press ***/tone ◀**.

Enter the desired number (like in the example above, the bank account number). These digits will be sent as tone dialing. This special number can be stored in a memory location. This is referred to as Chain Dialing (See page 17). Once the call ends, the tone mode is canceled and pulse dialing resumes.

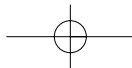

Traveling Out-of-Range

During a call, as you begin to move your handset too far from your base unit, noise increases. If you pass the range limits of the base unit, your call will terminate within 30 seconds.

Selecting a Different Channel

If you encounter interference while using your phone, you can manually change the phone's channel for clear operation. Interference can come from appliances or other phones in your home. This function works only when the phone is in use.

During the course of a conversation, if you hear static or noise which makes it difficult to hear, press **chan**. "Scanning" appears on the display, indicating the phone is changing to another channel. For more information on interference, refer to the enclosed Precautions and Warranty brochure.



You can cancel paging by pressing **page** key on the base.

Page

To locate the handset (while it's off the base), press **page** on the base. The handset beeps for 60 seconds.

Paging is canceled when pressing any handset key, **page** on the base or the handset is returned to the base.

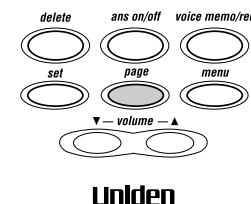

Flash and Call Waiting

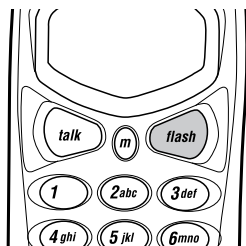

If you have "Call Waiting" service and a call waiting tone sounds while you are on a call, press **flash** to accept the waiting call. There is a short pause, then you will hear the new caller. To return to the original caller, press **flash** again.



You must subscribe through your local telephone company to receive Call Waiting Service.

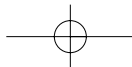



- In memory dialing operation, you must press a key within 20 seconds or the phone will return to standby. If you return the handset to the base, the phone will return to standby also.
- You have 20 seconds after pressing **m** to enter the number you wish to store. Otherwise, an error tone will sound.
- The pause feature is useful for long distance calling, credit card dialing, or sequences that require a pause between digits.
- The pause key counts as one digit. Pressing **redial/p** more than once increases the length of pause between numbers.

Storing Phone Numbers and Names

Memory Dialing allows you to dial a number using just a few key strokes. Your EXAI2980 series stores up to 10 names/numbers in the handset.

- 1) Press and hold **m** until "Memory Store" is displayed.
- 2) Press **▲** and **▼** or enter a number (0 - 9) to select the memory location where you would like to store the number.
- 3) Press **select**. The following screen appears and a cursor flashes indicating that the display is ready for the name to be entered.

If this screen appears, the selected memory location is already stored. Then you must either change the entry in this location, clear the entry in this location, or select "Go Back" to choose another location.

- 4) To enter a name (up to 14 characters), use number keys.

- See the "Steps for Entering Names and Special Characters" . (See page 15)
- Use **#▶** and ***/tone◀** to move the cursor to the desired location.
- Use **delete** to delete characters as needed.
- Press and hold **delete** to delete all the characters.
- If a name is not required, go to step 5.

- 5) Press **select**. "Store Number" is displayed. The cursor flashes indicating that the display is ready for the number to be entered.

- 6) Use the number keys to enter the phone number. The phone number cannot exceed 20 digits.
 - Use **redial/p** to enter pause in the dialing sequence. The display shows a "P" . Each pause counts as one digit and represents a two second delay of time between the digits as they are sent.
 - Use **delete** to delete digits as needed.

```
Memory Store
1▶
2
```

```
Store Name
█
```

```
Edit Memory 1
Delete Memory 1
Go Back
```

```
Store Number
█
```

```
Store Number
8002971023█
```

- 7) Press **select**. The handset beeps and displays the confirmation screen. Memory storage is complete. For example, if you store a name and number into memory location number 7, the display shows "Memory 7 Stored".
After about 2 seconds, "Memory Store" is displayed.
Repeat steps 2 - 7 to store more numbers.
- 8) Press **m** to return to standby mode.

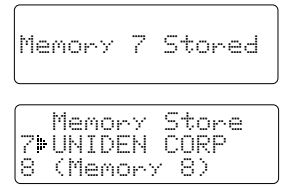

The 10 memory locations are represented by the numbers 0-9 on the keys. If you store a number in one of locations, then attempt to store a different number in the same location later, the new number will overwrite the previous one.

Steps for Entering Names and Special Characters

Refer to the letters on the number keys to select the desired characters. With each press of a numeric key, the displayed character appears in the following order : Upper case letters first, lower case letters next, and finally the number corresponding to the key.

If you make a mistake while entering a name
Use ***/tone** ◀ or **#** ▶ to move the cursor to the incorrect character, press **delete** to erase up to the wrong entry, then enter the correct character. To delete all characters, press and hold **delete**.

For example, to enter **Uniden** ;

- 1) Pick up the handset. Press and hold **m**.
- 2) Enter a number or press ▲ , ▼ to select a memory location number.
- 3) Press **select**.
- 4) Press **8** twice.
- 5) Press **6** five times.
- 6) Press **4** six times.
- 7) Press **3** four times, then press **#** ▶ to move the cursor to the right.
- 8) Press **3** five times.
- 9) Press **6** five times.
- 10) When finished, press **select**.

Keys	Number of times key is pressed								
	1	2	3	4	5	6	7	8	9
1	1								
2abc	A	B	C	a	b	c	2		
3def	D	E	F	d	e	f	3		
4ghi	G	H	I	g	h	i	4		
5jkl	J	K	L	j	k	l	5		
6mno	M	N	O	m	n	o	6		
7pqrs	P	Q	R	S	P	q	r	s	7
8tuv	T	U	V	t	u	v	8		
9wxyz	W	X	Y	Z	w	x	y	z	9
0	*	#	-	&	()	(blank)	0	



If the next character uses the same number key, you must press **#** ▶ to move the cursor over. Otherwise the next time you press the number key, it changes the character that was previously set.

To continue to store the telephone number, proceed to step 6 on page 14.



- If you press **select** before **talk**, you can confirm the name and the number stored in the selected memory location.
- To exit the memory function without dialing, press **m**. The handset returns to standby.
- Whenever you are using a menu screen, you must press a key within 20 seconds or the phone will return to standby.

Making Calls with Memory Dialing

Memory dialing from Standby Mode

- 1) Press **m**.
The handset displays your programmed memory locations.
- 2) Press ▲ and ▼ or enter a number (0 - 9) to select the memory location you would like to dial.
- 3) Press **talk**. "Talk" and the volume setting appear on the display. Then the displayed number is dialed.

```

1 UNIDEN CORP
2 JOHN DOE
3 MOM AND DAD
    
```

```

Talk
0123456789012
    
```

Display a programmed number

Use #▶ and */tone◀ to toggle between the names display and the numbers display.

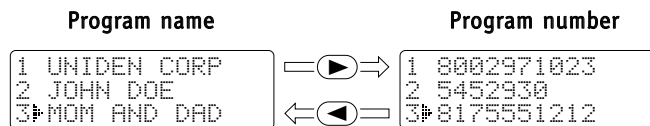

note When the stored phone number has 15 or more digits, "→" is displayed next to the 13th digit. Press #▶ to see the extra digits and */tone◀ to return.

```

5 012345678901
6 0118135543290→
7
    
```

Memory dialing from Talk Mode

- 1) Press **talk**. "Talk" and the volume setting appear.
- 2) Press **m**.
- 3) Enter a number (0 - 9) to select the memory location of the desired phone number. The selected phone number is displayed. Then the number is dialed.
- 4) To hang up, press **talk**.

```

Talk
Talk
Volume High
    
```

```

Talk 0:00
    
```

```

Talk 0:35
0123456789012
    
```

Chain Dialing

The 10 memory locations on the handset are not limited to phone numbers. You may want to store in memory a group of numbers (up to 20 digits) that you need to enter once your call connects. This is referred to as Chain Dialing.

An example of this is a bank account number. Once you have called your bank, when you are prompted to enter the account number, simply press **m** and then the location where the special number has been stored.

Store your special number with identifying name in memory as you would a phone number. (Refer to "Storing Phone Numbers and Names" on page 14.) Enter a pause as necessary in the sequence.

A pause counts as one digit and represents a two second delay in time between digits as they are sent.

Editing a Stored Name and/or Phone Number

- 1) Press and hold **m** until "Memory Store" is displayed.
- 2) Press **▲** and **▼** or enter a number (0 - 9) to select the memory location you would like to edit.
- 3) Press **select**.
The following screen appears with the memory location number that you have selected in the display.
- 4) Press **▲** or **▼** to select "Edit Memory", then press **select**.
The following screen appears.
The cursor flashes indicating that the display is ready for the name to be edited.
When a name has not been stored, the cursor appears at the beginning of the second line.
- 5) Use the number keys, ***/tone◀**, **#▶**, or **delete** to edit the name. (See page 14.)
To edit only the phone number, skip this step.
- 6) Press **select**. The following screen appears.
The cursor flashes indicating that the display is ready for the number to be edited.
- 7) Use the number keys, **redial/p** or **delete** to edit the phone number.
The phone number cannot exceed 20 digits. (See page 14.)
If you don't want to change the phone number, skip this step.

```
Memory Store
1 UNIDEN CORP
2 JOHN DOE
```

```
Edit Memory 1
Delete Memory 1
Go Back
```

```
Store Name
UNIDEN CORP
```

```
Store Number
8002971023
```

- 8) Press **select**. The handset beeps and displays the confirmation screen. The memory storage is complete.
For example, if you store a name and number into memory location number 1, the display shows "Memory 1 Stored". After about 2 seconds, "Memory Store" is displayed.
- 9) Press **m** to return to standby mode.

```
Memory 1 Stored
```

```
Memory Store
1 UNIDEN CORP
2 JOHN DOE
```

Erasing a Stored Name and Phone Number

- 1) Press and hold **m** until "Memory Store" is displayed.
- 2) Press ▲ and ▼ or enter a number (0 - 9) to select the memory location you would like to edit.
- 3) Press **select**.
The following screen appears with the memory location number that you have selected in the display.
- 4) Press ▼ to move the pointer down to "Delete Memory".
- 5) Press **select**. The following confirmation screen appears.
- 6) Press ▲ to move the pointer to "Yes".
- 7) Press **select** or **delete**.
The following screen appears.
- 8) After a few seconds the display returns to the "Memory Store" screen.
You may delete the information in another memory location (return to step 2) or press **m** to return to standby.

```
Memory Store
1 UNIDEN CORP
2 JOHN DOE
```

```
Edit Memory 2
Delete Memory 2
Go Back
```

```
Edit Memory 2
Delete Memory 2
Go Back
```

```
Delete Memory 2?
Yes
No
```

```
Memory 2 Deleted
```

```
Memory Store
2
3 MOM AND DAD
```

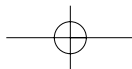

Caller ID

You must subscribe to Caller ID service to use this feature.

When the telephone rings, the Caller ID feature allows you to view the caller's name and phone number on the display before you answer the phone.

The handset displays the phone number of the incoming call, the name, time, and the number of calls.

Additionally, you can dial the displayed number and store the information for memory dialing.

Make sure you have turned on the Caller ID/Call Waiting feature. (See page 10.)

When the Telephone Rings

1) When the Caller ID message is received, the display shows the caller's phone number along with the date and time. The incoming call information is stored in the Caller ID record. If the Caller ID service includes the caller's name, the caller's name appears on the display (up to 15 letters).

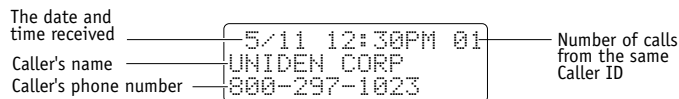

Here are some typical displays;

When the phone number and name data are received

```
5/11 12:30PM 01
UNIDEN CORP
800-297-1023
```

When invalid data is received

```
Incomplete Data
```

When a private name is received

```
5/11 12:30PM 01
Private Name
800-297-1023
```

When a private number is received

```
5/11 12:30PM 01
UNIDEN CORP
Private Number
```

When an unknown name is received

```
5/11 12:30PM 01
Unknown Name
800-297-1023
```

When an unknown number is received

```
5/11 12:30PM 01
UNIDEN CORP
Unknown Number
```

2) When you pick up the phone, the display changes to "Talk". (AutoTalk feature is set to on.)



Data errors appear as "■".



- If you answer a call before the Caller ID message is received (Example: before the second ring), the Caller ID message will not appear.
- When the call is received via a telephone company that does not offer Caller ID service, the caller's phone number and name do not appear. (This includes international calls.)
- When the call is via a private branch exchange (PBX), the caller's phone number and name may not appear.

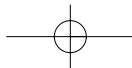
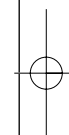



- In Caller ID operation, if no key is pressed for more than 20 seconds, an error tone sounds and the telephone returns to the standby mode.
- If a call comes in via a telephone system that does not offer Caller ID service, no information is stored.
- Each message can be up to 15 characters for the phone number and the name.
- While using the "Delete All?" or "Delete Message?" screen if no key is pressed for more than 20 seconds, an error tone sounds and the telephone returns to standby.
- If you get an incoming call or page, the deleting operation is canceled and the telephone returns to standby so you can answer the call or page.

Viewing the Caller ID Message List

The Caller ID list stores information for up to 30 incoming calls - even unanswered calls.

1) Press *call id*.

The summary screen appears.

The screen shows the number of new messages and total messages.

```
New :01
Total:02
```

2) Press ▼ to display the latest Caller ID message.

3) Press ▼ to see the next message. Or press ▲ to see previous message.

```
5/17 12:30PM 03
UNIDEN CORP
800-297-1023
```

4) Press *call id* to return to standby.

Deleting Information from the Caller ID List

The EXAI2980 series stores up to 30 messages. If the phone receives the 31st message, the oldest one in the list is automatically deleted. Caller ID data can also be deleted manually.

Deleting a Caller ID message

1) Press *call id*. Display the message to be deleted from the Caller ID list by pressing ▲ or ▼.

```
5/17 12:30PM 03
UNIDEN CORP
800-297-1023
```

2) Press *delete*.

3) Press ▲ or ▼ to select "Yes" or "No".

4) Press *select* or *delete*.

```
Delete Message?
▶ Yes
No
```

When the pointer is at "Yes":

A tone sounds and the Caller ID message is deleted. The Caller ID message is then displayed.

When the pointer is at "No":

The display returns to the Caller ID message.

```
New :01
Total:02
```

Deleting all Caller ID names/numbers

1) Press *call id*.

2) Press *delete*.

```
Delete All?
Yes
▶ No
```

3) Press **▲** or **▼** to select "Yes" or "No".

4) Press **select** or **delete**.

When the pointer is at "Yes":

A tone sounds and all stored Caller ID messages are deleted.

When the pointer is at "No":

The display returns to the summary screen.

Using the Caller ID List

Calling a party from the Caller ID list

You can place a call from the Caller ID list. The EXAI2980 series stores up to 30 messages.

1) Press **call id**. Select the phone number that you want to dial by pressing **▲** or **▼**.

2) Press **talk**. The displayed phone number dials automatically.

Long Distance calls and Area Code Setting/Cancellation

Pressing **1** while the incoming Caller ID information is displayed (in step 1) will place the prefix "1" in the display to set up or cancel for a long distance call. Pressing **3** will set or cancel an area code setting.

Dial edit

You can temporarily edit the Caller ID number that is displayed by pressing **select**. A cursor appears in the display. Press **delete** to move the cursor left, make your changes, and then press **talk**. This will not change the number in the Caller ID list memory. If you want to save this new number, store the information in memory. (See page 22).

Total:00

New :01
Total:02

5/17 12:30PM 03
UNIDEN CORP
800-297-1023

Talk
8002971023

note

- You cannot make a call from the Caller ID list if your EXAI2980 series is connected to private branch exchange (PBX).
- When a long distance call has been set, "1" appears in the display.



You can not store a Caller ID message if no phone number appears in the message.

Storing Caller ID messages in Memory dialing

Messages shown in the Caller ID list can be stored in memory dialing. Using the incoming call information (i.e., Caller ID list), the phone number of the party on the Caller ID list can be stored in memory.

- 1) Press **call id**.
Select the phone number to be stored from the Caller ID list by pressing ▲ or ▼.
- 2) Press **m**.
- 3) Press ▲ and ▼ or enter a number (0 - 9) to select the memory location to be stored.
- 4) Press **select**.
The number is stored in memory, and the display returns to the Caller ID list.



If a message has already been stored in the selected memory number location, a confirmation screen is displayed. Press ▲ to select "Yes". Press **select** to overwrite. The display returns to the Caller ID list.

```
Replace Memory?
Yes
▶No
```

```
5/17 12:30PM 03
UNIDEN CORP
800-297-1023
```

```
Select Location
1▶UNIDEN CORP
2 JONE DOE
```

```
5/17 12:30PM 03
UNIDEN CORP
800-297-1023
```

The Integrated Answering Device

The EXAI2980 series has a built-in answering system that answers and records incoming calls. You can also use your answering system to record a conversation, leave a voice memo message for others who use the phone, or to announce a special message to callers when you're away from your phone.

Features

- Digital Tapeless Recording
- 13 minutes of Recording Time
- Call Screening
- Selectable Outgoing Messages
- Voice Prompt for Guidance
- Time and Day Announcement
- Remote Message Retrieval
- Toll Saver
- Conversation Recording
- Voice Memo

Digital Tapeless Recording allows you to quickly review, save, or delete the messages you choose. You will never have to worry about a tape wearing out, jamming, or resetting improperly.

The Integrated Answering System is easy and convenient to use, but please read through all of the instructions carefully.

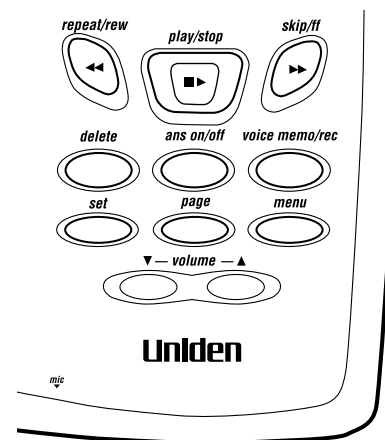

Turning the Answering System On/Off

- 1) To turn the answering system on, press **ans on/off**.
The current greeting message will be played and you will hear a tone. The message counter displays the number of messages stored in memory. If the display flashes, then there are new messages waiting for you.
- 2) To turn the answering system off, press **ans on/off** again.
After the announcement "Answer off", the message counter display goes out.



For your convenience, voice prompts will guide you through the menu mode.



- You can record a greeting up to 30 seconds long.
- Position yourself as near to the base as possible and speak clearly when recording your outgoing message.
- To exit menu mode, press **play/stop**. Otherwise, press **menu** again to confirm making your selection in the menu mode.

Setting up Your Answering System

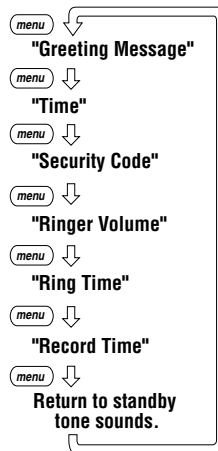

Using the Menu Mode

The Menu mode allows you to set the following Answering System functions.

- To scroll through the menu option, repeatedly press **menu**. The system returns to standby after the last menu option. A confirmation tone sounds to indicate Standby Mode.
- If any of the following occurs during menu setup, the handset returns to standby. Start over with menu function prior to the interruption.
 - Press **talk**
 - Press **play/stop**
 - 20 seconds lapse of time
- The idle time default setting is 20 seconds. If the handset remains idle for 20 seconds, a tone sounds and the system returns to standby.
- You can use volume ▲/▼ to adjust the announcement volume level during a voice prompt/guidance.

Setting Your Outgoing Message (Greeting)

When you receive a call, the answering system automatically plays either a preset message or your own greeting.

▼ Preset message

The following message is prerecorded:

"Hello, no one is available to take your call. Please leave a message after the tone."



See "Selecting the message record time", page 27 to set the announce only feature.

▼ Recording a personal outgoing message (Greeting)

- 1) Press **menu**. You hear the announcement "Greeting message", and the message counter displays [--]. The current greeting message will be played on the base speaker.
- 2) Press **voice memo/rec** to start recording your message. Start your recording after the announcement "Record your greeting after the tone".
- 3) When you are finished recording your greeting, press **voice memo/rec** or **play/stop**. You hear a tone after your greeting plays back on the base speaker.

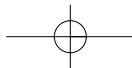

▼ Choosing between the two outgoing messages

Press **menu**. Then press **skip/ff** or **repeat/rew** when the outgoing message is played. This switches between the two options. Press **set** to select the greeting of your choice. A confirmation tone is heard.



To delete the personal Greeting, press **delete** during the announcement and the system announces "Your greeting has been deleted".

Setting the Time

The clock on the EXAI2980 series answering system starts when power is applied to the base. Follow these steps to set the clock to the correct time.

1) Press **menu** twice.

The system announces the current time. The message counter displays [--].

2) Press **set** to select the day.

You hear the current day and the numbers [0] through [6] are displayed on the base.

3) Press **skip/ff** or **repeat/rew** until the correct day is announced.

4) Press **set** to select the day.

5) Press **skip/ff** or **repeat/rew** until you hear the correct hour setting. The numbers [1] through [12] are displayed on the base as each hour is announced.

6) Press **set** to select the hour.

7) Press **skip/ff** or **repeat/rew** until you hear the correct minute setting. The numbers [00] through [59] are displayed on the base as each minute is announced.

8) Press **set** to select the minute.

9) Press **skip/ff** or **repeat/rew** until you hear the correct AM or PM setting.

The message counter displays [A] or [P].

10) Press **set** to select the AM/PM.

The EXAI2980 series announces the time that you have set and the base LED displays [--].

To exit the menu mode, press **play/stop** if desired.



- Normally the idle time for the menu mode is 20 seconds before the system returns to standby. However for setting the time, the idle time is extended to two minutes.
- Press and hold **skip/ff** or **repeat/rew** to quickly scroll through numbers on the display.

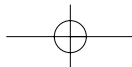



The PIN code is set to "80" when you purchase the EXAI2980 series.

Setting a Personal Security Code (PIN)

To play your messages from a remote location, you will need to enter a two-digit Personal Identification Number (PIN) code (00-99). To select a PIN, perform the following steps:

- 1) Press **menu** three times. The current PIN code is announced as it is displayed on the base.
- 2) Press **set** to change the PIN code. The system announces current PIN code.
- 3) Press **skip/ff** or **repeat/rew** until the desired number appears.
- 4) Press **set** to select the PIN code. The system announces the new PIN code.

To exit the menu mode, press **play/stop** if desired.

Setting the base ringer volume

You have three ringer options. One allows you to turn the ringer off. The other two are volume levels.

- 1) Press **menu** four times.
You hear the current ringer option ([*H*] High, [*L*] Low, [*OFF*] off), and it is displayed on the base.
- 2) Press **set**.
- 3) Press **skip/ff** or **repeat/rew** until the desired ringer option appears.
- 4) Press **set** to select the ringer option. The system announces new ringer volume.

To exit the menu mode, press **play/stop** if desired.

Adjusting the speaker volume level

Adjust the volume of the base speaker by pressing the **volume** keys on the base. Press ▲ for louder or ▼ for softer. The numbers 0-9 are displayed on the base indicating the volume levels. 0 being the softest and 9 being the loudest.

Setting the ring time

The ring time setting allows you to set the number of rings the caller hears before your answering system plays the outgoing message. You can set the ring time to answer after two, four, or six rings. Setting **LS** (Toll Saver), the answering system picks up after two rings if you have new messages, and after four rings if there are none. This way, if you make a long distance call to check your messages, you can hang up after the second ring to avoid billing charges.

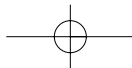

- 1) Press **menu** five times.
You hear the current ring time ([2] 2, [4] 4, [6] 6, [5] Toll saver), and it is displayed on the base.
- 2) Press **set** to change the ring time.
- 3) Press **repeat/rew** or **skip/ff** until the desired ring time appears.
- 4) Press **set** to select the new ring time. The system announces the new ring time.

Selecting the message record time

You have three record time options. The options "1 minute", or "4 minutes" set the duration for recording the incoming messages. "Announce only" answers the call with the preset greeting or your personal greeting but prevents the caller from leaving a message.

- 1) Press **menu** six times.
You hear the current recording time ([1] 1 minute, [4] 4 minutes, [R] Announce only), and it is displayed on the base.
- 2) Press **set** to change the recording time.
- 3) Press **repeat/rew** or **skip/ff** until the desired time appears.
- 4) Press **set** to select the new recording time. The system announces new recording time.

▼ Announce only feature

The announce only feature plays a prerecorded outgoing message or the previously set personal outgoing message, but it will not allow the caller to leave a message. To set "Announce only", follow the steps above.

To choose between the prerecorded message or your own personal greeting, press **skip/ff** or **repeat/rew** when the outgoing message is played. Press **set** to select the greeting of your choice. A confirmation tone sounds. If you want to use your own greeting, you may want to change your greeting to omit the prompt to leave a message. Refer to "Recording a personal outgoing message" (Greeting) on page 24.

The following message is prerecorded:
"Hello, no one is available to take your call. Please call again."



- When using the Announce only feature, you may want to change your outgoing message, if the message prompts the caller to leave a message. The prerecorded message changes automatically.
- To exit the menu mode press **play/stop** if desired.

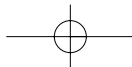
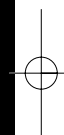



To stop playing your messages, press **play/stop** again at any time.

Using Your Answering System

The message counter displays the number of messages stored in memory. If the display flashes, then there are new messages are waiting for you. The flashing number represents the number of new messages, not total messages. The EXAI2980 series is designed to play your new messages first. After you play all your new messages, you can then play your old messages.



When the answering system is full, *FL* is displayed on the base, and the system announces "No remaining time". You should delete some messages so that the system can record new messages. (Refer to "Deleting a message" on page 29.)

Playing your messages

1) Press **play/stop**.

The system announces the number of new and old messages and the LED displays the number of messages. The time and day that each message was received is announced after the message is played, and the message counter displays the number of the current messages.

When all new messages have been played, you hear a beep. The system returns to standby.

2) After you have reviewed your new messages, you can play your old messages by again pressing **play/stop**. Once you have listened to a new message, it then becomes an old message. The old messages will then be played in the order in which they were received.

Repeating a Message

1) Press **play/stop** to review your messages. The number of stored messages are announced.

2) After a message has played for a few seconds, press **repeat/rew** to replay the message. If you have several messages, press **repeat/rew** repeatedly until you return to the message you want to replay.

3) Press **play/stop** at any time to stop reviewing messages and return to standby. The message counter shows the number of messages stored in memory.

*To scroll backward through the message more quickly, press and hold **repeat/rew**.*

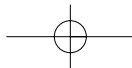

Skipping a message

- 1) Press **play/stop** to review your messages. The number of messages is announced.
- 2) Press **skip/ff** at anytime to skip to the next message.
Each time **skip/ff** is pressed, the system scans forward one message. If you have several messages, press **skip/ff** to find the message you want to play.
- 3) Press **play/stop** at any time to stop reviewing your messages and return to standby. The message counter shows the number of messages stored in memory.
*To scroll forward through the message more quickly, press and hold **skip/ff**.*

Deleting a message

To maintain maximum record time, it is a good idea to delete the old messages.

- 1) Press **play/stop** to review your messages.
- 2) Press **delete** anytime during the message to delete the message.
- 3) You hear a beep and the message is deleted.
To delete all messages, press and hold **delete** after reviewing your messages. You hear a beep and the message is deleted followed by the announcement "Messages have been deleted".

When you try to delete all messages without first listening to your new messages, you hear several short beeps followed by an announcement "Please playback all messages". This protects you from accidentally erasing messages you have not heard yet.

Voice memo

The voice memo function allows the user to record messages (up to 10 minutes).

- 1) Press and hold **voice memo/rec**.
You hear a beep. The message counter displays [- -].
- 2) Start your recording after the announcement "Record your message after the tone".
- 3) When you have finished, press **play/stop** or **voice memo/rec** to stop recording.
The system returns to standby.



- When you press **delete**, you are permanently deleting the message. Once deleted, the message cannot be replayed.
- The voice memo function is completely independent of the greeting message. It's easy to leave others quick messages.
- The voice memo messages are recorded as incoming messages.

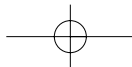



- A recorded conversation is treated as a typical message and will be added to the stored messages.
- When recording a conversation, all handset keys, except *flash*, are disabled. Stop recording if you need to enable any other handset keys.

Recording a conversation

You can record up to 10 minutes of conversation while you are using your phone.

- 1) During a conversation from the handset, press and hold **voice memo/rec.**

The unit begins recording and the message counter displays [--].

A beep that can be heard by both parties, sounds during recording.



If you receive a call waiting tone while recording a conversation, press **flash** to accept the waiting call. The recording feature continues recording the new call. The original call is put on hold.

- 2) To stop recording, press **play/stop** or **voice memo/rec.**

Remote access away from home

You can operate your answering system from a remote location using any touch-tone telephone. Use this function to check for recorded messages, to play or delete messages, even to record a new greeting message.

- 1) Call your telephone number.
- 2) During the greeting message playbacks, press **#** and enter your PIN code.
(See "Setting a Personal Security Code", page 26).
- 3) The answering system announces the number of messages stored in memory.
You hear "To play incoming messages, press pound two. For help, press pound zero".
- 4) You may continue to listen to the Help Guidance, or you may select a command from the following chart:

Command	Function
# then 1	Repeat a Message
# then 2	Playing your Messages
# then 3	Skipping a Message
# then 4	Deleting a Message
# then 5	Stop Message Playback

Command	Function
# then 6	Answering System On
# then 7	Memo Record/Stop
# then 8	Greeting Message Record/Stop
# then 9	Answer System Off
# then 0	Help Guidance

* For Memo Record and Greeting Message Record function, the first time you enter the corresponding command, it starts the Recording function. If you want to stop the recording, enter the command again.

- 5) After all of the Help Guidance menu has played, you hear intermittent beeps indicating that the system is in the command waiting mode. You may enter another command at this time from the chart.
- 6) When you are finished, hang up to exit the system. The answering system automatically returns to standby.

Turn on the answering system remotely

If you have forgotten to turn on your answering system, you can turn it on remotely from any touch-tone telephone.

- 1) Call your telephone number.
- 2) Wait ten rings until the system answers. You hear a beep.
- 3) Press **#** and then enter your PIN code. The answering system announces the number of messages stored in memory. You hear "To play incoming messages, press pound two. For help, press pound zero".
- 4) Press **#** then **6** to turn the answering system on.
- 5) Hang up the phone and subsequent calls will be answered by the system.



- You must enter a command within 15 seconds of entering command waiting mode or the answering system automatically hangs up and returns to standby.
- The system will only playback messages for four minutes and then it returns to command waiting mode. To continue playing your messages, press **#** then **2** again within 15 seconds.

THE INTEGRATED
ANSWERING DEVICE

note

If the handset battery pack is completely discharged or the battery pack is removed, the digital security code will be lost. If this happens, a new security code is set automatically next time the battery pack is charged.

Changing the Digital Security Code

The digital security code is an identification code used to connect the handset and the base unit. Normally, setting the code is not necessary.

The first time you charge your handset, the security code is automatically set. (See "About the digital security code", page 5.) In the rare situation that you suspect another cordless telephone is using the same security code, you can change the code.

- 1) Remove the handset from the base unit. Press and hold **page** on the base.
- 2) While the handset is emitting the paging sound, place the handset on the base unit holding **page**. The paging sound stops.
Leave the handset on the base for more than 5 seconds or until flashing stops.
A new random security code is set.

Installing the Beltclip

To attach the beltclip

Insert the beltclip into the holes on each side of the handset. Press down until it clicks.

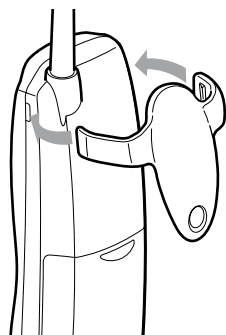

To remove the beltclip

Pull both sides of the beltclip to release the tabs from the holes.

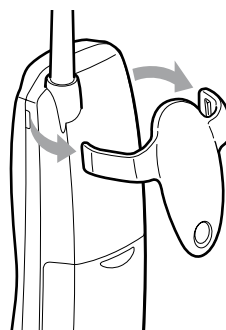

Headset Installation

Your phone may be used with an optional headset, the Uniden HS910. To use this feature, insert headset plug into the headset jack. Your phone is ready for hands-free conversations.

(Headset may be purchased by calling the Uniden Parts Department or visiting the web site. See Page 4.)

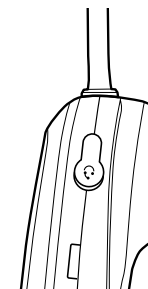

note

If the beltclip is attached, you can only charge the handset in the face down position.

Note on Power Sources

Battery replacement and handling

When the operating time becomes short, even after a battery is recharged, please replace the battery.

With normal usage, your battery should last about one year.

Please contact your place of purchase or the Uniden Parts Department for a replacement battery.

RECYCLING NICKEL-CADMIUM BATTERIES



NICKEL-CADMIUM BATTERIES MUST BE DISPOSED OF PROPERLY.

Nickel-cadmium cells are used in the battery pack. Please take your used nickel-cadmium battery packs to a store that recycles nickel-cadmium batteries.

Power Failure

During the period that the power is off, you will not be able to make or receive calls with the telephone.

Caution

- Use the specified battery pack.
- Do not remove the battery from the handset to charge it.
- Never throw the battery into a fire, disassemble it, or heat it.
- Do not remove or damage the battery casing.

Maintenance

When slightly dirty

Wipe with a soft, dry cloth.

When very dirty

Wipe with a soft cloth that has been dampened with diluted, neutral detergent. Dry with a dry cloth.

When the charging terminals become dirty

Wipe with a dry cloth or a pencil eraser, if necessary.

Caution

Do not use paint thinner, benzene, alcohol, or other chemical products. Doing so may discolor the surface of the telephone and damage the finish.

General Information

The phone complies with FCC Parts 15 and 68.

Operating temperature: 0° to 50°C (+32°F to +122°F)

AC Adapter Information

AC Adapter part number:	AD-420
Input Voltage:	120V AC 60Hz
Output Voltage:	9V DC 350 mA

Battery Information

Battery part number:	BT-905
Capacity:	600 mAh, 3.6V
Battery use time (per charge) From fully charged	
Talk mode duration:	7 hours
Standby mode duration:	14 days



If the handset is left off of the base, the actual Talk mode duration will be reduced respective to the amount of time the handset is off the base.

Recharge your phone on a regular basis by returning the handset to the base after each phone call. When the operating time becomes short, even after the battery is recharged, please replace the battery. With normal usage, the battery should last about one year.

Replacement batteries may be purchased at your local Uniden dealer or by contacting the Uniden Parts Department (800) 554-3988. Hours are from 7:00 a.m. to 5:00 p.m. Central Time, Monday through Friday. We can also be reached on the web at www.uniden.com

Specifications, features, and availability of optional accessories are all subject to change without prior notice.

ADDITIONAL INFORMATION [33]

ADDITIONAL
INFORMATION

Troubleshooting

If your phone is not performing to your expectations, please try these simple steps first.

Symptom	Suggestion
The status LED won't light when the handset is placed in the base.	<ul style="list-style-type: none"> • Make sure the AC adapter is plugged into the base and wall outlet. • Make sure the handset is properly seated in the base. • Make sure the charging contacts on the handset and base are clean.
The audio sounds weak and/or scratchy.	<ul style="list-style-type: none"> • Make sure that the base antenna is in a vertical position. • Move the handset and/or base to a different location away from metal objects or appliances and try again. • Press chan to help eliminate background noise. • Make sure that the handset is not too far from the base.
Can't make or receive calls.	<ul style="list-style-type: none"> • Check both ends of the base telephone line cord. • Make sure the AC adapter is plugged into the base and wall outlet. • Disconnect the AC adapter for a few minutes, then reconnect it. • Reset the digital security code (See page 32). • Make sure that the handset is not too far from the base.
The Caller ID does not display.	<ul style="list-style-type: none"> • The handset was picked up before the second ring. • The call was placed through a switch board. • Call your local telephone company to verify your Caller ID service is current.
The handset doesn't ring or receive a page.	<ul style="list-style-type: none"> • The battery pack may be weak. Charge the battery on the base unit for 15-20 hours. • The handset may be too far away from the base unit. • Place the base unit away from appliances or metal objects. • Reset the digital security code (See page 32).

[34] ADDITIONAL INFORMATION

Symptom	Suggestion
Severe noise interference.	<ul style="list-style-type: none"> • Keep the handset away from microwave ovens, computers, remote control toys, wireless microphones, alarm systems, intercoms, room monitors, fluorescent lights, and electrical appliances. • Move to another location or turn off the source of interference.
The answering system does not work.	<ul style="list-style-type: none"> • Make sure the base unit is plugged in. • Make sure the answering system is turned on.
The answering system does not answer calls.	<ul style="list-style-type: none"> • Set the record time to either the one minute or four minute option. • The memory may be full. Delete some or all of the saved messages.
Messages are incomplete.	<ul style="list-style-type: none"> • The incoming messages may be too long. Remind callers to leave a brief message. • The memory may be full. Delete some or all of the saved messages.
After a power failure, the outgoing message is deleted.	<ul style="list-style-type: none"> • Record your personal outgoing message again. The default message should remain.
No sound on the base unit speaker during call monitoring or message playback.	<ul style="list-style-type: none"> • Adjust the speaker volume on the base unit.
Cannot access remote call-in features from another touch-tone phone.	<ul style="list-style-type: none"> • Make sure you're using the correct PIN code. • Make sure that the touch-tone phone you're using can transmit the tone for at least two seconds. If it cannot, you may have to use another phone to access your messages.
If you still have a problem.	<ul style="list-style-type: none"> • Call our customer hotline at 1-800-297-1023.

Index

- A**
- AC adapter information33
 - Announce only feature.....27
 - Answering system
 - Deleting a message29
 - Playing a message28
 - Recording a conversation30
 - Remote access30
 - Repeating a message28
 - Skipping a message29
 - Turning on/off23
- B**
- Base location5
 - Battery pack
 - Information33
 - Installing6
 - Preparing and charging6
 - Replacement and handling33
 - Beltclip installation32
- C**
- Caller ID
 - Caller ID service19
 - Deleting20
 - Setting Caller ID options.....10
 - Using21
 - Viewing.....20
 - Call waiting13
 - Chain dialing17
 - Channel13
- Charging the battery pack6**
- Cleaning Battery Contacts7**
- Clock25**
- Connect the base unit7**
- Controls and Functions2, 3**
- D**
- Dial mode8
 - Digital security code5, 32
- E, F, G, H, I, J, K, L**
- Earpiece volume12
 - Flash13
 - General information (Specification)33
 - Greeting24
 - Headset installation32
 - Interference13
 - Language10
- M, N, O, P, Q**
- Maintenance33
 - Making a call11
 - Memory dialing
 - Editing a stored name and phone number17
 - Erasing a stored name and phone number18
 - Making calls with memory dialing16
 - Storing phone numbers and names ..14
 - Menu mode24
 - Outgoing message.....24
- Package contents4**
- Page13**
- Personal Security Code (PIN code)26**
- R**
- Receiving a call11
 - Recording time.....27
 - Redial12
 - Remote access30
 - Repeating28
 - Ringer volume
 - Base.....26
 - Handset12
 - Ring time26
- S**
- Setting up the Phone5
 - Storing phone number14
- T, U**
- Tone12
 - Traveling out-of-range.....13
 - Troubleshooting34
- V, W, X, Y, Z**
- Voice memo29
 - Volume control12, 26
 - Wall mounting9

[36] ADDITIONAL INFORMATION

At Uniden, we'll take care of you!

If you need any assistance with this product, please call our Customer Hotline at

1-800-297-1023

PLEASE DO NOT RETURN THIS PRODUCT TO THE PLACE OF PURCHASE.

Our Uniden representatives will be happy to help you with any matters regarding the operation of this unit, available accessories, or any other related matters.

Thank you for purchasing a Uniden product.
Hours: M-F 7:00 AM to 7:00 PM CST.

A World Without Wires | **Uniden**[®]

Covered under one or more of the following U.S. patents:
4,511,761 4,523,058 4,595,795 4,797,916 5,381,460 5,426,690
5,434,905 5,491,745 5,533,010 5,574,727 5,650,790 5,660,269
5,661,780 5,663,981 5,671,248 5,717,312 5,754,407 5,768,345
5,787,356 5,838,721 5,864,619 5,893,034 5,912,968 5,915,227
5,929,598 5,930,720 5,960,358 5,987,330 6,044,281 6,070,082
6,125,277

© 2001 Uniden America Corporation, Fort Worth, TX
All rights reserved.

Printed in China
UCZZ01312DA

Free Manuals Download Website

<http://myh66.com>

<http://usermanuals.us>

<http://www.somanuals.com>

<http://www.4manuals.cc>

<http://www.manual-lib.com>

<http://www.404manual.com>

<http://www.luxmanual.com>

<http://aubethermostatmanual.com>

Golf course search by state

<http://golfingnear.com>

Email search by domain

<http://emailbydomain.com>

Auto manuals search

<http://auto.somanuals.com>

TV manuals search

<http://tv.somanuals.com>