

Uniden®

EXI 7246

SERIES

OWNER'S

MANUAL

OWNER'S MANUAL

Download from www.Somanuals.com. All Manuals Search And Download.

EXI7246/EXI7246C

Step 1 Checking the Package Contents

Make sure your cordless phone's packaging includes the following items.

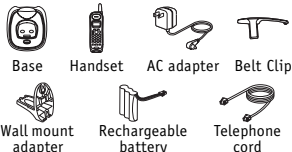

Also included: • Owner's manual

Step 2 Install Handset Battery Pack and Charge

Note Use **ONLY** the Uniden rechargeable battery pack supplied with your new phone!

1 Remove the cover.



2 Connect the battery pack with the correct polarity.

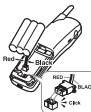

3 Replace the cover.



www.uniden.com

Step 3 Set up the Base

1 Plug the AC Adapter cord to the **DC IN 9V** jack (yellow).

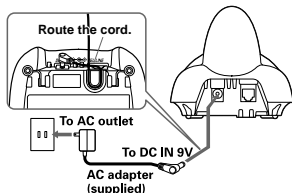

2 Plug the AC Adapter to a 120V AC power outlet.

Note Use **ONLY** the Uniden AC Adapter supplied with your new phone!

Step 4 Charging the Handset

Place the handset in the base. Make sure that charge LED illuminates.

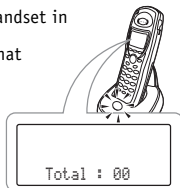

Charge the handset 15-20 hours.

Fully charge the battery pack by placing the handset in the base before using phone.

Step 5 Connect to the Phone Line

1 Plug one end of the telephone cord into the base **TEL LINE** jack.



2 Plug the other end into the telephone wall jack.

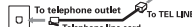

Step 6 Make & Receive Calls

To Make a Call

1 Press **talk/flash**.

2 Listen for dial tone.

3 Dial the desired number.



To Receive a Call

Pick up the handset and press **talk/flash**.



To Hang Up a Call

Press **end** or return the handset to the base.



Additional Features

For more information on these and other features, please refer to your Owner's Manual. For your convenience, listed below are important features that will help you set up your new cordless phone.

Handset/Base Set up:

- Adjust the Earpiece Volume →P.18
- Set the Ringer Volume →P.16
- Set Tone/Pulse Dialing →P.15

Caller ID:

Set Caller ID on Call Waiting (CIDCW) →P.13

Note: You must subscribe to Caller ID services through your local telephone provider to use Caller ID and CIDCW.

Refer to your Owner's Manual for detailed operations.

For questions, contact our Customer Hotline (800) 297-1023. To order genuine Uniden parts & accessories, contact our Uniden Parts Department (800) 554-3988

EXI7246/EXI7246C

1° Paso Inspección del contenido del embalaje

Asegúrese de que haya recibido los siguientes artículos en el paquete (la cantidad de artículos puede variar según el modelo que haya comprado)



2° Paso Instalación y carga de la pila para el receptor

Nota ¡Use **SOLAMENTE** el paquete de pilas recargable de Uniden suministrado con su nuevo teléfono!

1 Quite la tapa.



2 Conecte el paquete de pilas con la polaridad correcta.

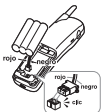

3 Reponga la tapa



3° Paso Programación de la base

1 Conecte el adaptador CA en el enchufe (amarillo) CC IN 9V.

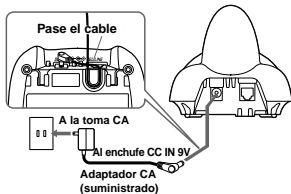

2 Conecte el adaptador CA en una toma de 120V CA.

Note ¡Use **SOLAMENTE** el adaptador CA de Uniden suministrado con su teléfono!

4° Paso Carga del receptor

Coloque el receptor en la base. Asegúrese de que el LED de carga se ilumine.

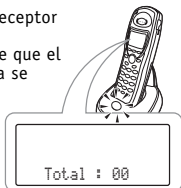

Cargue el receptor de 15 a 20 horas.

Cargue el paquete de pilas totalmente colocando el receptor en la base antes de usar el teléfono.

5° Paso Conexión de la línea telefónica

1 Conecte un extremo de la línea telefónica en el enchufe TEL LINE en la base.



2 Conecte el otro extremo en el enchufe telefónico de la pared.

6° Paso Realización y recepción de llamadas

Para hacer una llamada

- 1 Oprima **talk/flash**.
- 2 Espere por el tono de marcación.
- 3 Marque el número deseado.



Para recibir una llamada

Levante el receptor y oprima **talk/flash**.



Para colgar una llamada

Oprima **end** o devuelva el receptor a la base.



Características adicionales

Para más información sobre estas y otras características, le rogamos que consulte su Manual del usuario. Para su conveniencia, hemos listado abajo unas características importantes, las cuales le ayudarán a programar su nuevo teléfono inalámbrico de Uniden.

Programación del receptor/base:

- Ajuste del volumen del timbre y del auricular →P.18
- Programación del volumen del timbre →P.16
- Programación de la marcación por tono/pulso →P.15

Identificación de llamadas (Caller ID):

Programa la Identificación de llamadas en Llamadas en espera (CIDCW) →P.13

Nota: Usted debe estar suscrito al servicio de Identificación de llamadas con su proveedor de telefonía local para poder usar las características de Caller ID y de CIDCW

Consulte su manual del usuario para operaciones más detalladas.

Si tiene preguntas, comuníquese con nuestra Línea Roja para el Consumidor en el (800) 297-1023.

Para comprar partes y accesorios genuinos de Uniden, comuníquese con nuestro Departamento de Partes de Uniden en el (800)554-3988.

Contents

QUICK REFERENCE GUIDE	1		
Welcome/Features	4		
Controls and Functions	5		
Terms Used in this Manual	6		
Getting Started			
Installing the Phone	7		
A. Choose the Best Location	7		
B. Install the Rechargeable Battery Pack into the Handset	8		
C. Connect the Base Unit and Charge the Handset	9		
D. Mount the base unit on a wall	10		
Installing the Beltclip	11		
Headset Installation	12		
Basic Setup	13		
Activating AutoTalk	13		
Activating Caller ID on Call Waiting	13		
Entering Your Area Code	14		
Choosing the Dialing Mode	15		
Setting the Language	15		
Selecting the Ring Tone and Volume	16		
Basics			
Using Your Phone	17		
Making and Receiving Calls	17		
Adjusting the Earpiece Volume	18		
Tone Dialing Switch-over	19		
Traveling Out-of-Range	19		
Selecting a Different Channel	19		
Find Handset	20		
		Using Call Waiting	20
		Voice Mail Waiting Indicator	21
		RocketDial	
		RocketDial	22
		Storing the RocketDial	22
		Using the Speed Dial Memory	
		Using the Speed Dial Memory	23
		Storing Names and Numbers in Speed Dial Memory	23
		Storing Caller ID messages in Speed Memory Locations	26
		Making Calls from Speed Dial Memory	27
		Caller ID Features	
		Caller ID and CIDCW (Caller ID on Call Waiting)	28
		When the Telephone Rings	28
		Viewing the Caller ID Message List	29
		Deleting Information from the Caller ID List	30
		Making a Call from the Caller ID List	31
		Additional Information	
		Changing the Digital Security Code	32
		Note on Power Sources	33
		General Information	35
		Troubleshooting	36
		Liquid Damage	38
		Precautions & Warranty	39
		I.C. Notice	41
		Index	42
		Memory List	43

Welcome

Congratulations on your purchase of the Uniden cordless telephone. This phone is designed and engineered to exacting standards for reliability, long life, and outstanding performance.

Note: Illustrations in this manual are used for explanation purposes. Some illustrations in this manual may differ from the actual unit. The color of your cordless phone may vary.



As an Energy Star[®] Partner, Uniden has determined that this product or product models meets the Energy Star[®] guidelines for energy efficiency. Energy Star[®] is a U.S. registered mark.

Features

- 2.4GHz Extended Range Technology
- 3 Line Backlit Display
- Caller ID and Caller ID on Call Waiting
- 10 Number Memory Dialing
- One touch RocketDial[®]
- Last Number Redial
- Voice Mail Waiting Indicator
- English, French or Spanish Support
- Pulse/Tone Dialing
- Find Handset
- Earpiece Volume Control
- Ringer Volume Control
- Hearing Aid Compatible
- 20 Channel Autoscan

Be sure to visit our web site: www.uniden.com

Uniden[®] and RocketDial[®] are registered trademarks of Uniden America Corporation. AutoTalk, AutoStandby, UltraClear Plus, Random Code, and AutoSecure are trademarks of Uniden America Corporation.

Controls and Functions

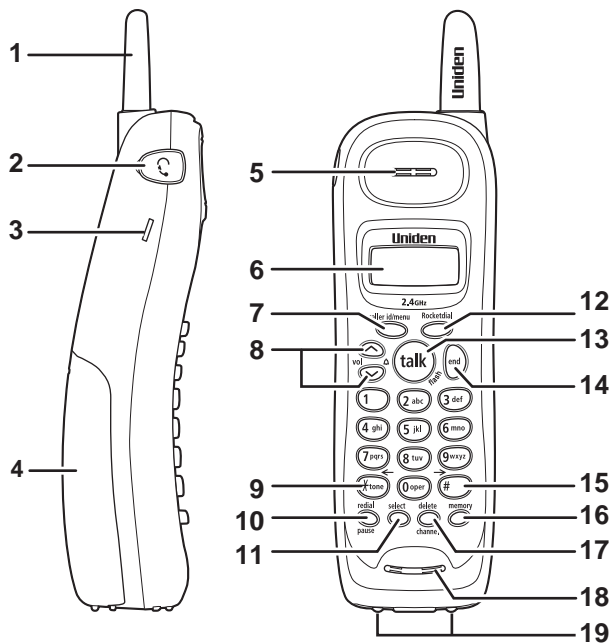

1. Handset antenna
2. Jack for optional headset
3. Beltclip hole
4. Handset battery compartment
5. Handset earpiece
6. LCD display
7. caller id/menu key (pages 13 and 28)
8. \wedge / ∇ /vol/ Δ (earpiece volume, ringer volume and scroll) key (pages 13, 16 and 18)
9. $*$ /tone/ \leftarrow key (left cursor) key (pages 19 and 23)
10. redial/pause key (pages 18 and 25)
11. select key (page 13)
12. Rocketdial key (page 22)
13. talk/flash key (pages 17 and 20)
14. end key (pages 17 and 18)
15. $\#$ / \rightarrow (right cursor) key (page 23)
16. memory key (page 23)
17. delete/channel key (pages 19, 23 and 30)
18. Handset microphone and ringer speaker
19. Handset charging contacts

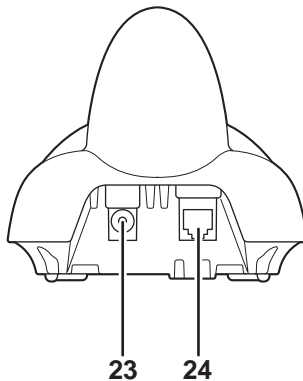
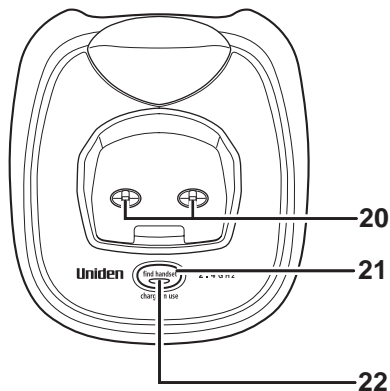

- 20. Base charging contacts
- 21. find handset key (pages 20 and 32)
- 22. charge/in use and VMWI (Voice Mail Waiting Indicator) LED
- 23. DC IN 9V jack
- 24. Telephone line jack

Terms Used in this Manual

- Standby Mode - The handset may be sitting in or off the base, but is NOT in use. The **talk/flash** key has not been pressed and there is no dial tone.
- Talk Mode - The handset is off the base and the **talk/flash** key has been pressed, enabling a dial tone.
- CID - Caller ID
- CIDCW - Caller ID on Call Waiting
- RocketDial - One touch speed dial

Installing the Phone

Do the following steps:

- Choose the Best Location
- Install the Rechargeable Battery Pack into the Handset
- Connect the Base Unit and Charge the Handset
- Mount the Base Unit on a Wall

A. Choose the Best Location

When choosing a location for your new phone, here are some important guidelines you should consider:

Avoid heat sources, such as radiators, air ducts, and sunlight

Avoid television sets and other electronic equipment

Choose a central location

Avoid noise sources such as a window by a street with heavy traffic

Avoid microwave ovens

Avoid excessive moisture, extremely low temperatures, dust, mechanical vibration, or shock

Avoid personal computers

Avoid other cordless telephones

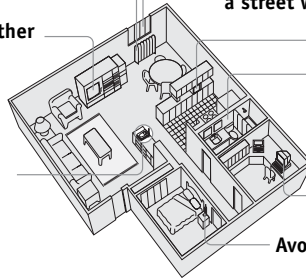

- The location should be close to both a phone jack and a continuous power outlet (one which is not connected to a switch).
- The base and handset should be kept away from sources of electrical noise such as motors, microwave ovens, and fluorescent lighting.
- The base can be placed on a desk, tabletop, or mounted on a standard wall plate.
- There should be enough space to fully extend the antenna.



note

If your home has specially wired alarm equipment connected to the telephone line, be sure that installing the system does not disable your alarm equipment.

If you have questions about what will disable your alarm equipment, contact your telephone company or a qualified installer.



- Use only the Uniden (BT-905) rechargeable battery pack supplied with your cordless telephone.
- Replacement batteries are also available through the Uniden Parts Department at (800) 554-3988, Monday through Friday from 8:00 a.m. to 5:00 p.m. or online at www.uniden.com

B. Install the Rechargeable Battery Pack into the Handset

The handset is powered by a rechargeable battery pack. The battery recharges automatically when the handset is placed in the base unit.

- 1) Press down on the handset battery case cover (use the finger indentation for a better grip) and slide the cover downward to remove.
- 2) Plug the battery pack connector (red & black wires) into the jack inside the battery compartment. (The connector notches fit into the grooves of the jack only one way.) Match the wire colors to the polarity label in the battery compartment, connect the battery and listen for a click to insure connection.
- 3) Make sure you have a good connection by slightly pulling on the battery wires. If the connection is secure, the battery jack will remain in place.
- 4) Place the battery case cover back in the handset by sliding it upwards until it clicks into place.

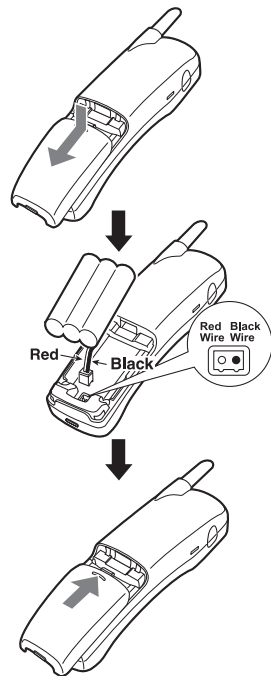

C. Connect the Base Unit and Charge the Handset

- 1) Connect the AC adapter to the **DC IN 9V** jack and to a standard 120V AC wall outlet.
- 2) Place the handset in the base unit with the keypad facing forward.
- 3) Make sure the **charge/in use** LED illuminates. If the LED does not illuminate, check to see that the AC adapter is plugged in and the handset makes good contact with the base charging contacts.



- Connect the AC adapter to a continuous power supply.
- Place the base unit close to the AC outlet so that you can unplug the AC adapter easily.

- 4) Charge your handset at least 15-20 hours before plugging into the phone line.
- 5) Once the handset battery pack is fully charged, connect the telephone line cord to the **TEL LINE** jack and a telephone outlet. If your telephone outlet isn't modular, contact your telephone company for assistance.

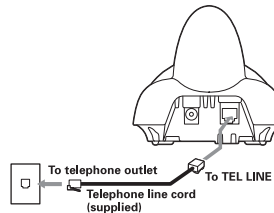
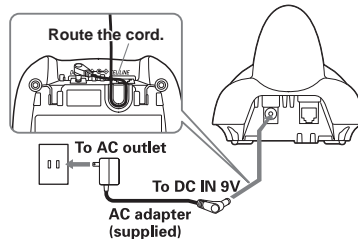

- Use only the supplied AD-0001 AC adapter. Do not use any other AC adapter.
- Do not place the power cord where it creates a trip hazard or where it could become chafed and create a fire or electrical hazard.

D. Mount the base unit on a wall

Standard wall plate mounting

This phone can be mounted on any standard wall plate.

- 1) Locate the base unit on the wall mount adapter as shown and slide the wall mount adapter into the notches on the base bottom with the tab pressed.
- 2) Plug the AC adapter to the **DC IN 9V** jack.
- 3) Route the AC adapter cord through the molded wiring channel as shown.
- 4) Plug the AC adapter into a standard 120V AC wall outlet.
- 5) Plug the telephone line cord into the **TEL LINE** jack. Route the cord through the molded wiring channel as shown.
- 6) Plug the telephone line cord into the telephone outlet.
- 7) Align the mounting slots on the base with the mounting posts on the wall. Then push in and down until the phone is firmly seated.

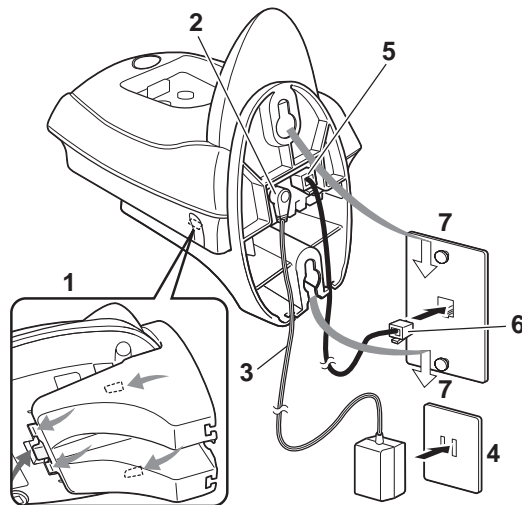

Direct wall mounting

If you don't have a standard wall plate, you can mount your phone directly to the wall. Before doing this, consider the following:

- Avoid electrical cables, pipes, or other items behind the mounting location that could cause a hazard when inserting screws into the wall.
- Try to mount your phone within 5 feet of a working phone jack to avoid excessive cord lengths.
- Make sure the wall material is capable of supporting the weight of the base and handset.
- Use #10 screws (minimum length of 1-3/8 inches) with anchoring devices suitable for the wall material where the base unit will be placed.

- 1) Insert two mounting screws into the wall, (with their appropriate anchoring device), 3-15/16 inches apart. Allow about 1/8 of an inch between the wall and screw heads for mounting the phone.
- 2) Refer to steps 1 through 7 on page 10 to mount the telephone.

Installing the Beltclip

To attach the beltclip

Insert the beltclip into the holes on each side of the handset. Press down until it clicks.

To remove the beltclip

Pull both sides of the beltclip to release the tabs from the holes.

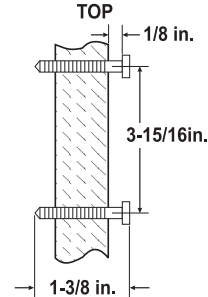

Headset Installation

Your phone may be used with an optional headset, the Uniden HS910. To use this feature, insert the headset plug into the headset jack. Your phone is ready for hands-free conversations. (Headset may be purchased by calling the Uniden Parts Department or visiting the web site. See page 35.)



Basic Setup

There are five basic options that you will need to set up: AutoTalk, CIDCW (Caller ID on Call Waiting), Area Code, Dial Mode and Language.

Activating AutoTalk

AutoTalk allows you to answer the phone simply by removing the handset from the base. You do not have to press any keys.

- 1) When the phone is in standby mode, press and hold the *caller id/menu* key. The following screen appears.
- 2) Press the *select* key to turn AutoTalk on.
- 3) Press the *end* key to complete the setting. The handset returns to standby mode.

```

Auto Talk  :Off
CIDCW      :On
Area Code  :
  
```

Activating Caller ID on Call Waiting

Caller ID allows you to see the name and number of the calling party before you answer the phone. Caller ID on Call Waiting (CIDCW) lets you see the name and number of a call that comes in when you are on the line.

You must subscribe to Caller ID service through your local telephone provider to use this feature.

- 1) When the phone is in standby mode, press and hold the *caller id/menu* key. The following screen appears.

```

Auto Talk  :Off
CIDCW      :On
Area Code  :
  
```

2) Press the **▼/vol/▲** key to select CIDCW.

```
Auto Talk :Off
▶CIDCW   :On
Area Code :
```

3) Press the **select** key to toggle and turn on Caller ID on Call Waiting.

4) Press the **end** key and return the handset to the base unit to complete the setting. The handset returns to standby mode.

Entering Your Area Code

If you enter a 3-digit area code number in the `Area Code` option, your local area code does not appear in Caller ID messages. Do not program this option if your calling area requires 10-digit dialing. When reviewing Caller ID messages, you will see only the local seven digit number. For calls received from outside your local area code, you will see a full 10-digit number.

1) When the phone is in standby mode, press and hold the **caller id/menu** key. The following screen appears.

```
▶Auto Talk :Off
CIDCW     :On
Area Code :
```

2) Press the **▼/vol/▲** key twice to select Area Code.

```
Auto Talk :Off
CIDCW     :On
▶Area Code :
```

3) Press the **select** key. If an area code was already stored, the phone will display it.

4) Use the number keys **(0 - 9)** to enter the 3-digit area code. If you make an error, use the **delete/channel** key to backspace.

```
Auto Talk :Off
CIDCW     :On
Area Code :■
```

5) Press the **select** key. A confirmation tone sounds.

6) Press the **end** key to complete the setting. The handset returns to standby mode.

Choosing the Dialing Mode

Most phone systems use tone dialing. However some phone systems (such as in rural areas) still use pulse dialing. Your Uniden phone supports both tone and pulse dialing. The default setting is tone dialing. If your phone system uses pulse dialing, follow the steps below to change the dialing mode:

- 1) When the phone is in standby mode, press and hold the **caller id/menu** key. The following screen appears.
- 2) Press the **∨/vol/△** key three times to select Dial.
- 3) Press the **select** key to set the phone to pulse dialing.
- 4) Press the **end** key to complete the setting. The handset returns to standby mode.

```

▶Auto Talk  :Off
CIDCW      :On
Area Code  :
  
```

```

CIDCW      :On
Area Code  :
▶Dial      :Pulse
  
```

Setting the Language

There are three languages to choose from; English, French and Spanish.

- 1) When the phone is in standby mode, press and hold the **caller id/menu** key. The following screen appears.
- 2) Press the **∨/vol/△** key four times to select Language.
- 3) Press the **select** key to select Eng, Fr. or Esp.
- 4) Press the **end** key to complete the setting. The handset returns to standby mode.

```

▶Auto Talk  :Off
CIDCW      :On
Area Code  :
  
```

```

Area Code  :
Dial       :Tone
▶Language   :Eng
  
```



- If you are not sure of your dialing system, make a trial call. If the call connects, leave the setting as is. Otherwise, set for pulse dialing.
- If your phone system requires pulse dialing and you need to send DTMF tones during a call, you can temporarily switch over to tone dialing. (Refer to "Tone Dialing Switch-over" on page 19.)

Selecting the Ring Tone and Volume

Your phone has five different ringer tone/volume combinations you can choose from.

- 1) With the phone in standby mode, press the **^/vol/** or **∇/vol/** key.
- 2) The phone will sound the different ring tones at different volumes.
- 3) When the phone sounds the ring tone and volume you wish to use, press the **end** key.

Using Your Phone

Making and Receiving Calls

Making a call

- 1) Remove the handset from the base.
- 2) Press the **talk/flash** key.
- 3) Listen for the dial tone.
- 4) Dial the number.

OR

- 1) Remove the handset from the base.
- 2) Dial the number.
- 3) Press the **talk/flash** key.

Receiving a call

- 1) Remove the handset from the base. (If AutoTalk is on, the phone will automatically answer the call when you pick it up.)
- 2) Press the **talk/flash** key.

OR

- 1) If the handset is off the base, press the **talk/flash** key or any number key. (AutoTalk is on.)

Hanging up

Press the **end** key or return the handset to the base.



Refer to page 13 "Basic Setup" to turn on the AutoTalk feature if desired.

Redialing the last dialed number

- 1) Remove the handset from the base.
- 2) Press the **talk/flash** key.
- 3) Listen for the dial tone.
- 4) Press the **redial/pause** key.

OR

- 1) Remove the handset from the base.
- 2) Press the **redial/pause** key.
- 3) Press the **talk/flash** key.

Adjusting the Earpiece Volume

To change the earpiece volume, press the \wedge /**vol**/ \triangle or \vee /**vol**/ \triangle key during a call.

Temporarily Mute Ringer

If the handset is off the base while an incoming call is ringing, simply press the **end** key to temporarily mute the incoming ring. The ringer will sound with the next incoming call.

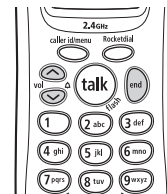

Tone Dialing Switch-over

If your telephone company requires pulse dialing, you can switch-over to tone dialing after the call connects. This feature is useful when you need tone dialing to use any automated menu systems, such as telephone bank tellers, telephone prescription refills, customer support menus, etc.

If your phone is set to pulse dialing mode, make your call normally. Once your call connects, press the ***/tone/←** key. Any digits you enter from then on will be sent as tone digits. When this particular call ends, the phone automatically returns to pulse dialing mode.



Traveling Out-of-Range

During a call, as you begin to move your handset too far from your base unit, noise increases. If you pass the range limits of the base unit, your call will terminate within one minute.

Selecting a Different Channel

If you encounter interference while using your phone, you can manually change the phone's channel for clear operation. While using your phone, press the **delete/channel** key. Scanning9 appears on the display, indicating the phone is changing to another channel. For more information on interference, refer to "Precautions" on page 40.



The **UltraClear Plus™** true compander circuitry virtually eliminates background noise. This innovative technology, together with 20 different channels, provides you with the best possible reception during all your conversations.

Find Handset

To locate the handset, press the *find handset* key on the base. The handset beeps for 60 seconds.

Paging is canceled when pressing any handset key, the *find handset* key on the base or the handset is returned to the base.

Paging is also canceled when the phone receives an incoming call.



Using Call Waiting



If you have Call Waiting service, you can receive calls while on the line.

- 1) If a call comes in while you are on the phone, you will hear a call waiting tone. If you have CIDCW activated, you will see the name and number of the incoming caller.
- 2) Press the *talk/flash* key to accept the waiting call. After a short pause, you will hear the new caller.
- 3) To return to the original caller, press the *talk/flash* key again.



You must subscribe through your local telephone company to receive Call Waiting service.

Voice Mail Waiting Indicator

If you subscribe to voice mail service, you can use your cordless telephone to access your voice mailbox. The **charge/in use** LED on the base of your phone flashes whenever you have messages waiting in your voice mailbox.

Just dial the access number supplied by your voice mail provider to enter your mailbox. You can program your voice mail access number to a speed dial number. If the voice mail waiting indicator remains on after you have retrieved your messages, press and hold the **find handset** key for 5 seconds. This will reset the indicator.



You must subscribe to voice mail service from your telephone company in order to use this feature. The voice mail company will provide you with the access number.

RocketDial

RocketDial is a one-touch speed dial key. Store your most important or most frequently called number as your RocketDial number. Then, simply press the **RocketDial** key, and your phone will automatically dial the number.

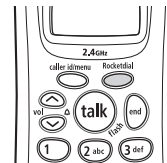

Storing the RocketDial

- 1) When the phone is in standby mode, press and hold the **RocketDial** key. The following display appears.

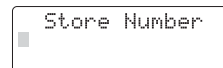

If the RocketDial number is already programmed, the Edit screen appears. You can select Edit to edit this entry, select Delete to erase this entry or select Go Back to return to the standby mode.

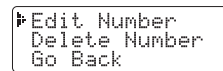

- 2) Store the number by following step 6 under "Storing Names and Numbers in Speed Dial Memory" on page 25.
- 3) Press the **select** key.
You hear a confirmation tone, and Number Stored appears.
Memory storage is complete.

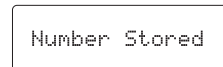
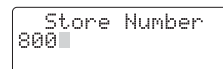

Using the Speed Dial Memory

The speed dial memory allows you to store up to 10 names and numbers in the handset. You can dial these numbers with just a few key presses.

The speed dial memory is not limited to phone numbers. You can store any number (up to 20 digits) that you need to enter once your call connects. This is referred to as Chain Dialing. For example, you can save your bank account number to speed dial memory. When you call your bank's telephone teller service and are prompted to enter your account number, simply press the **memory** key and the speed dial number where you stored your account number. Then press the **select** key.

Storing Names and Numbers in Speed Dial Memory

- 1) With the phone in standby mode, press the **memory** key.
- 2) Enter **0-9** to select the speed dial number where you would like to store this entry. You can also scroll through the list with the **^/vol/▲** and **▼/vol/△** keys. Press the **select** key twice.
- 3) Store Name appears and a cursor flashes indicating that the display is ready for the name to be entered.

If the selected speed dial number is already assigned, the Edit screen appears. You can select Edit to edit this entry, select Delete to erase this entry, delete this entry, or select Go Back to choose another speed dial number.

```
Select Memory
01▶
02 JOHN DOE
```

```
Store Name
█
```

```
▶ Edit Memory01
Delete Memory01
Go Back
```



When editing the speed dial memory, you must press a key within 30 seconds or the phone will return to standby mode. If you return the handset to the base, the phone will return to standby mode also.



If the next character uses the same number key, you must press the **#/→** key to move the cursor over. Otherwise the next time you press the number key, it changes the character that was previously set.

- 4) Enter a name according to the instructions below, then press the **select** key. If no name is required, go to step 5.
 - The name can be up to 13 characters.
 - Use the **#/→** and ***/tone/←** keys to move the cursor to the desired location.
 - Use the **delete/channel** key to delete characters as needed.
 - Press and hold the **delete/channel** key to delete all the characters.

Refer to the letters on the number keys to select the desired characters. With each press of a numeric key, the displayed character appears in the following order: Upper case letters first, lower case letters next and finally the number corresponding to the key.

If you make a mistake while entering a name

Use the ***/tone/←** or **#/→** key to move the cursor to the incorrect character. Press the **delete/channel** key to erase the wrong character. Then enter the correct character. To delete all characters, press and hold the **delete/channel** key.

For example, to enter **Movies**.

- 1) Press **6**. Then press the **#/→** key to move the cursor to the right.
- 2) Press **6** six times.
- 3) Press **8** six times.
- 4) Press **4** six times.
- 5) Press **3** five times.
- 6) Press **7** eight times.

	Number of times key is pressed								
keys	1	2	3	4	5	6	7	8	9
1	1								
2abc	A	B	C	a	b	c	2		
3def	D	E	F	d	e	f	3		
4ghi	G	H	I	g	h	i	4		
5jkl	J	K	L	j	k	l	5		
6mno	M	N	O	m	n	o	6		
7pqrs	P	Q	R	S	p	q	r	s	7
8tuv	T	U	V	t	u	v	8		
9wxyz	W	X	Y	Z	w	x	y	z	9
0oper	*	#	-	&	()	(blank)	0	

- 5) Store Number is displayed. The cursor flashes indicating that the display is ready for the number to be entered.

```
Store Number
█
```

- 6) Use the keypad to enter the phone number; each number can be up to 20 digits.

```
Store Number
8007303456█
```

If you need the phone to pause during the dialing sequence, press the **redial/pause** key to insert a two-second delay between the numbers. You can enter multiple pauses to increase the delay. Each pause counts as a digit. The display shows a P for every pause.

- note** When storing numbers into memory, if the handset is idle (i.e., no key is pressed) for more than 30 seconds, it will beep rapidly, and the phone will return to standby mode.

- 7) Press the **memory** key. You will hear a confirmation tone, and the following screen appears.

```
Memory01 Stored
```

Memory storage is complete.

After about 2 seconds, the following screen displays all the speed dial memory entries.

```
01# Movies
02 JOHN DOE
03 MOM AND DAD
```

- 8) Press the **end** key to exit memory setup mode. The phone returns to standby.



You cannot store a Caller ID message if no phone number appears in the message.

Storing Caller ID messages in Speed Memory Locations

Messages (Caller ID names/numbers) shown in the Caller ID list can be stored in memory dialing. For instructions on viewing the Caller ID Message list, see page 29.

- 1) Press the **caller id/menu** key. Select the phone number to be stored from the Caller ID list by pressing the **^/vol/** or **v/vol/** key.

```
5/17 12:30PM  
Jane Smith  
214-555-1234
```

- 2) Press the **memory** key.

```
Select Memory  
01▶  
02 JOHN DOE
```

- 3) Enter a number (**0 - 9**) or press the **^/vol/** or **v/vol/** key to select the memory location to be stored.

- 4) Press the **select** key. You hear a confirmation tone, and the number is stored in memory. The display returns to the Caller ID list.

```
5/17 12:30PM  
Jane Smith  
214-555-1234
```



If a message has already been stored in the selected memory number location, a confirmation screen is displayed. Press the **^/vol/** key to select **Yes**. Press the **select** key to overwrite. The display returns to the Caller ID list.

```
Replace Memory?  
Yes  
▶No
```

Making Calls from Speed Dial Memory

- 1) Press the **memory** key. The handset displays your programmed speed dial number.
- 2) Enter the number (**0 - 9**), or press the **^/vol/** or **∇/vol/** key to select the speed dial number you would like to dial.
- 3) Press the **talk/flash** key. Talk and the number selected appear on the display. Then the displayed number is dialed.

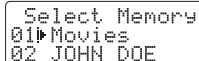

Select Memory
01 Movies
02 JOHN DOE



>Talk<
8007303456

To cancel speed dialing

Press the **end** key to cancel speed dialing. The handset returns to standby mode. Also, if the handset is idle (e.g., no key is pressed) for 30 seconds, the phone returns to standby mode.



- If you answer a call before the Caller ID message is received (for example, before the second ring), the Caller ID message will not appear.
- When the call is received via a telephone company that does not offer Caller ID service, the caller's phone number and name do not appear. (This includes international calls.)
- When the call is via a private branch exchange (PBX), the caller's phone number and name may not appear.

Caller ID and CIDCW (Caller ID on Call Waiting)

You must subscribe to Caller ID service through your local telephone provider to use this feature. When the telephone rings, the Caller ID feature allows you to view the caller's name, phone number, date and time of call. With CIDCW (Caller ID on Call Waiting), you will hear a Call Waiting tone while you are on a call, and the Caller ID data is displayed. To accept the waiting call, press the *talk/flash* key (see page 20).

Additionally, you can dial a number stored in the Caller ID list or save data to your Memory dial list.

When the Telephone Rings

When the Caller ID message is received, the display shows the caller's phone number along with the date and time. The incoming call information is stored in the Caller ID record. If the Caller ID service includes the caller's name, the caller's name appears on the display (up to 15 letters).

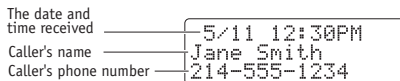

You may receive any one of the following messages:

When invalid data is received	Incomplete Data
When a private name is received	Private Name
When a private number is received	Private Number
When an unknown name is received	Unknown Name
When an unknown number is received	Unknown Number



Data errors appear as "■".

Viewing the Caller ID Message List

The Caller ID list stores information for up to 30 incoming calls - even unanswered calls.

- 1) With the phone in standby mode, press the **caller id/menu** key. The summary screen appears. The screen shows the number of new messages and total messages.
- 2) To view the Caller ID messages in historical order (from new to old or from old to new), repeatedly press the **▼/vol/▲** key to scroll through the messages from the latest to the earliest, or the **▲/vol/▲** key to scroll back through the messages.
- 3) Press the **end** key to return to standby mode.

```
Caller ID
New :01
Total:02
```

```
5/17 12:30PM
Jane Smith
214-555-1234
```

note

- In Caller ID operation, if no key is pressed for more than 30 seconds, an error tone sounds and the telephone returns to standby mode.
- Each message can be up to 15 characters for the name and 15 digits for the phone number.
- The number of calls from the same Caller ID appears next to the received time. Once you view the new message, the number will be cleared and disappear.



- While using the Delete All? or Delete Message? screen, if no key is pressed for more than 30 seconds, an error tone sounds, and the handset returns to standby mode.
- If you get an incoming call or page, the deleting operation is canceled, and you can answer the call or page.

Deleting Information from the Caller ID List

The cordless phone stores up to 30 Caller ID names/numbers. If the phone receives the 31st Caller ID, the oldest one in the list is automatically deleted. Caller ID data can also be deleted manually.

Deleting a Caller ID message

- 1) Press the *caller id/menu* key in standby mode. Find the message to be deleted from the Caller ID list by pressing the \wedge /*vol*/ \triangle or \vee /*vol*/ \triangle key.
- 2) Press the *delete/channel* key.
- 3) Press the \wedge /*vol*/ \triangle or \vee /*vol*/ \triangle key to select Yes, and then press the *select* key.

```
5/17 12:30PM
Jane Smith
214-555-1234
```

```
Delete Message?
▶ Yes
No
```

Deleting all Caller ID names/numbers

- 1) With the phone in standby mode, press the *caller id/menu* key.
- 2) Press the *delete/channel* key.
- 3) Press the \wedge /*vol*/ \triangle or \vee /*vol*/ \triangle key to select Yes, and then press the *select* key.
You hear a confirmation tone and all stored Caller ID messages are deleted.

```
Caller ID
New :01
Total:02
```

```
Caller ID
Total:00
```

Making a Call from the Caller ID List

You can place a call from the Caller ID list.

- 1) Press the **caller id/menu** key in standby mode. Select the phone number that you want to dial by pressing the **^/vol/** or **∨/vol/** key.
- 2) To have the phone dial a "1" before the displayed Caller ID number, press **1**. To have the phone dial the stored area code before the displayed Caller ID number, press **3**.
- 3) Press the **talk/flash** key. The displayed phone number dials automatically.

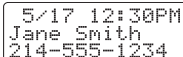

5/17 12:30PM
Jane Smith
214-555-1234



note

You cannot make a call from the Caller ID list if your cordless phone is connected to a private branch exchange (PBX).

Changing the Digital Security Code

To protect you against misbilled calls which might result from your phone being activated by other equipment, the cordless phone provides **AutoSecure**TM (which electrically locks your phone when the handset is in the base) and **Random Code**TM digital security which automatically selects one of over 262,000 digital security codes for the handset and base.

If the handset battery pack is completely discharged or the battery pack is removed, the digital security code will be lost. If this happens, a new security code is set automatically the next time the battery pack is charged. In the rare situation that you suspect another cordless telephone is using the same security code, you can change the code.

- 1) Remove the handset from the base unit. Press and hold the **find handset** key on the base.
- 2) While holding the **find handset** key, place the handset in the base unit, and leave the handset in the base for more than 3 seconds. A new random security code is set.

Note on Power Sources

Low battery alert

When the battery pack is very low and needs to be charged, the phone is programmed to eliminate functions in order to save power. If the phone is not in use, **Low Battery** appears on the LCD and none of the keys will operate. If the phone is in use, **Low Battery** flashes and the handset beeps. Complete your conversation as quickly as possible and return the handset to the base unit for charging.

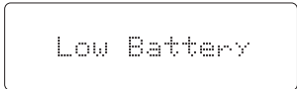

Information stored in the phone's memory will be retained for 30 minutes after the battery pack is removed. This includes all setup information, last number dialed, speed dial memory, RocketDial programming, and the CID list.

Even when the battery pack is not being used, it will gradually discharge over a long period of time. For optimum performance, be sure to return the handset to the base unit after a telephone call.

Battery replacement and handling

When the operating time becomes short even after a battery is recharged, please replace the battery. With normal usage, your battery should last about one year. Please contact your place of purchase or the Uniden Parts Department for a replacement battery.

Warning: To avoid the risk of personal injury or property damage from fire or electrical shock, only use the Uniden battery model and Uniden adapter model specifically designated for this product.

Power Failure

During the period that the power is off, you will not be able to make or receive calls with the telephone.

Caution

- Use only the specified Uniden battery pack (BT-905).
- Do not remove the battery from the handset to charge it.
- Never throw the battery into a fire, disassemble it, or heat it.
- Do not remove or damage the battery casing.

Cleaning the battery charging contacts

To maintain a good charge, clean the charging contacts on the handset once a month.

Dampen a cloth with plain water. Gently rub the damp cloth over the charging contacts until all visible dirt is removed. Dry the contacts thoroughly before returning the handset to the base.

Caution

Do not use paint thinner, benzene, alcohol, or other chemical products. Doing so may discolor the surface of the telephone and damage the finish.

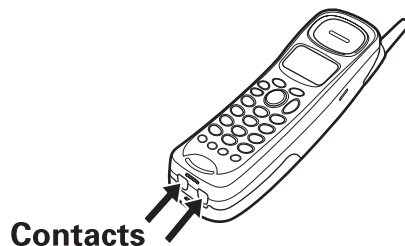

General Information

The phone complies with FCC Parts 15 and 68.

Operating temperature: -10°C to +50°C (+14°F to +122°F)

AC Adapter Information

AC Adapter part number: AD-0001
Input Voltage: 120V AC 60Hz
Output Voltage: 9V DC 210 mA

Battery Information

Battery part number: BT-905
Capacity: 600 mAh, 3.6V

Frequency: 924.516925 - 926.704425 MHz
2,405.155942 - 2,411.718441 MHz



- **To avoid damage to the phone use only Uniden AD-0001 and BT905 with your phone.**
- If the handset is left off of the base, the actual Talk mode duration will be reduced respective to the amount of time the handset is off the base.

Recharge your phone on a regular basis by returning the handset to the base after each phone call. When the operating time becomes short, even after the battery is recharged, please replace the battery. With normal usage, the battery should last about one year.

A replacement Uniden adapter and battery may be purchased at your local Uniden dealer or by contacting the Uniden Parts Department (800) 554-3988. Hours are from 8:00 a.m. to 5:00 p.m. Central Time, Monday through Friday. We can also be reached on the web at www.uniden.com. Specifications, features, and availability of optional accessories are all subject to change without prior notice.

Troubleshooting

If your phone is not performing to your expectations, please try these simple steps first.

Symptom	Suggestion
The <i>charge/in use</i> LED won't illuminate when the handset is placed in the base.	<ul style="list-style-type: none">• Make sure the AC adapter is plugged into the base and wall outlet.• Make sure the handset is properly seated in the base.• Make sure the charging contacts on the handset are clean.
The audio sounds weak and/or scratchy.	<ul style="list-style-type: none">• Move the handset and/or base away from metal objects or appliances and try again.• Press the <i>delete/channel</i> key in the Talk mode to help eliminate background noise.• Make sure that the handset is not too far from the base.
Can't make or receive calls.	<ul style="list-style-type: none">• Check both ends of the telephone line cord.• Make sure the AC adapter is plugged into the base and wall outlet.• Disconnect the AC adapter for a few minutes. Then reconnect it.• Change the digital security code (see page 32).• Make sure that the handset is not too far from the base.• Check the dialing mode used by your telephone company.

Symptom	Suggestion
The handset doesn't ring or receive a page.	<ul style="list-style-type: none"> • The battery pack may be weak. Charge the battery for 15-20 hours. • The handset may be too far from the base unit. • Place the base unit away from appliances or metal objects. • Change the digital security code (see page 32). • Check the battery pack to ensure there is a secure connection. • Make sure ringer volume isn't set to turned "off."
Severe noise interference.	<ul style="list-style-type: none"> • Keep the handset away from microwave ovens, computers, remote control toys, wireless microphones, alarm systems, intercoms, room monitors, fluorescent lights, and electrical appliances. • Move to another location or turn off the source of interference.
The Caller ID does not display.	<ul style="list-style-type: none"> • The call was answered before the second ring. • The call was placed through a switchboard. • Charge the handset. • Your Caller ID service may not be active; contact your local telephone service provider.
Voice Message Indication does not work.	<ul style="list-style-type: none"> • Contact your local telephone company to make sure that your telephone receives FSK message signaling. • Reset the indicator by pressing and holding the <i>find handset</i> key for 5 seconds.
If you still have a problem.	<ul style="list-style-type: none"> • Call our customer hotline at 1-800-297-1023.

Liquid Damage

Moisture and liquid can damage your cordless phone. In case of accidental submersion, please follow these steps.

Case	Action
If the handset or base is exposed to moisture or liquid, but it only affects the exterior plastic housing.	Wipe off the liquid, and use as normal.
If moisture or liquid has entered the plastic housing (i.e., liquid can be heard in the phone or liquid has entered the handset battery compartment or vent openings on the base).	<p>Handset:</p> <ol style="list-style-type: none">1.Remove the battery cover and leave it off for ventilation2.Remove the battery pack by disconnecting3.Leave the battery cover off and the battery pack disconnected for at least 3 days4.Once the handset is completely dry, reconnect the battery pack and the battery cover.5.Recharge the handset's battery pack for 20 hours before using again. <p>Base:</p> <ol style="list-style-type: none">1.Disconnect the AC adapter from the base unit, cutting off electrical power.2.Disconnect the telephone cord from the base unit.3.Let dry for at least 3 days. <p>IMPORTANT: You must unplug the telephone line while recharging the battery pack to avoid charge interruption.</p> <p>CAUTION: DO NOT use a microwave oven to speed up the drying process. This will cause permanent damage to the handset, base and the microwave oven. After following these steps, if your cordless telephone does not work, please send to:</p> <p style="text-align: center;">Uniden America Corporation Parts and Service Division 4700 Amon Carter Blvd. Ft. Worth, TX 76155 1-800-554-3988, Monday through Friday 8 a.m. to 5 p.m. CST</p>

Precautions!

Before you read anything else, please observe the following:

Warning!

Uniden America Corporation DOES NOT represent this unit to be waterproof. To reduce the risk of fire, electrical shock, or damage to the unit, DO NOT expose this unit to rain or moisture.

Rechargeable Nickel-Metal-Hydride Battery Warning

- This equipment contains a rechargeable nickel-cadmium battery.
- Cadmium is a chemical known to the State of California to cause cancer.
- The rechargeable nickel-cadmium battery contained in this equipment may explode if disposed of in a fire.
- Do not short-circuit the battery.
- Do not charge the rechargeable nickel-cadmium battery used in this equipment in any charger other than the one designed to charge this battery as specified in the owner's manual.
- Using another charger may damage the battery or cause the battery to explode.

Rechargeable Nickel-Cadmium Batteries Must Be Recycled or Disposed of Properly

- Uniden voluntarily participates in an RBRC® industry program to collect and recycle nickel-cadmium batteries at the end of their useful life, when taken out of service within the United States.
- The RBRC® program provides a convenient alternative to placing used nickel-cadmium batteries into the trash or municipal waste stream, which is illegal in some areas.
- Through the RBRC® program, Uniden makes it easy for you to drop off the used battery at local retailers of replacement nickel-cadmium batteries. You may also contact your local recycling center for information on where to return the used battery. Please call 1-800-8-BATTERY for information on Ni-Cd battery recycling in your area.
- Uniden's involvement in this program is part of its commitment to protecting our environment and conserving natural resources.
- RBRC® is a registered trademark of the Rechargeable Battery Recycling Corporation.



The exclamation point within an equilateral triangle is intended to alert the user to the presence of important operating and maintenance (servicing) instructions in the literature accompanying the appliance.

Uniden works to reduce lead content in our PVC coated cords in our product and accessories.

WARNING: The cords on this products and/or accessories contain lead, a chemical known to the State of California to cause birth defects or other reproductive harm. **Wash hands after handling.**

www.uniden.com



Important Safety Instructions

When using your telephone equipment, these basic safety precautions should always be followed to reduce the risk of fire, electrical shock, and injury to persons:

1. Read and understand all instructions.
2. Follow all warnings and instructions marked on the product.
3. Unplug this product from the wall outlet before cleaning. Use a dry cloth for cleaning without liquid or aerosol cleaners.
4. Do not use this product near water; for example, near a bathtub, wash bowl, kitchen sink or laundry tub, in a wet basement, or near a swimming pool.
5. Do not place this product on an unstable cart, stand, or table. The telephone may fall, causing serious damage to the unit.
6. Slots and openings in the cabinet and the back or bottom are provided for ventilation. To protect the product from overheating, these openings must not be blocked or covered. This product should never be placed near or over a radiator or heat register. This product should not be placed in a built-in installation unless proper ventilation is provided.
7. This product should be operated only from the type of power source indicated on the marking label. If you are not sure of the type of power supply to your home, consult your dealer or local power company.
8. Do not allow anything to rest on the power cord. Do not locate this product where the cord will be damaged by persons walking on it.
9. Do not overload wall outlets and extension cords, as this can result in the risk of fire or electrical shock.
10. Never push objects of any kind into this product through cabinet slots, as they may touch dangerous voltage points or short out parts that could result in a risk of fire or electric shock. Never spill liquid of any kind on the product.
11. To reduce the risk of electric shock, do not disassemble this product. Take it to qualified service personnel when service or repair work is required. Opening or removing covers may expose you to dangerous voltages or other risks. Incorrect reassembly can cause electric shock when the appliance is subsequently used.
12. Unplug this product from the wall outlet and refer servicing to qualified service personnel under the following conditions:
 - A. When the power supply cord is damaged or frayed.
 - B. If liquid has been spilled into the product.
 - C. If the product has been exposed to rain or water.
 - D. If the product does not operate normally when following the operating instructions. (Adjust only those controls that are covered by the operating instructions. Improper adjustment of other controls may result in damage and will often require extensive repair work by a qualified technician.)
 - E. If the product has been dropped or the cabinet has been damaged.
 - F. If the product exhibits a distinct change in performance.
13. Do not use the telephone to report a gas leak in the vicinity of the leak.

Additional Battery Safety Precautions

Caution! To reduce the risk of fire or injury to persons by the battery, read and follow these instructions:

1. Use only the Uniden battery pack specified in the owner's manual.
2. Do not dispose of the battery pack in a fire. The cell may explode. Check the nickel-cadmium battery disposal package insert for disposal instructions.
3. Do not open or mutilate the battery pack. Released electrolyte is corrosive and may cause damage to the eyes or skin. It may be toxic if swallowed.
4. Exercise care in handling the battery in order not to short the battery with conducting materials such as rings, bracelets, and keys. The battery or conductor may overheat and cause burns.
5. Charge the battery pack provided with or identified for use with this product only in accordance with the instructions and limitations specified in the owner's manual provided for this product.
6. Observe proper polarity orientation between the battery pack and battery charger.

SAVE THESE INSTRUCTIONS!

Important Electrical Considerations

Unplug all electrical appliances when you know an electrical storm is approaching. Lightning can pass through your household wiring and damage any device connected to it. This phone is no exception.

The FCC Wants You To Know

Changes or modifications to this product not expressly approved by Uniden, or operation of this product in any way other than as detailed by the owner's manual, could void your authority to operate this product. Your telephone complies with Part 68 of FCC Rules. You must, upon request, provide the FCC registration number and the REN to your telephone company. Both numbers are on the base unit.

- Note:**
- You must not connect your phone to:
 - coin-operated systems
 - most electronic key telephone systems

This device complies with Part 15 of the FCC rules. Operation is subject to the following two conditions: (1) This device may not cause harmful interference, and (2) This device must accept any interference received, including interference that may cause undesired operation. Privacy of communications may not be ensured when using this phone.

Range

Your new phone is designed to achieve the maximum possible range by transmitting and receiving according to the highest specifications set forth by the FCC. We have rated this phone to operate at a maximum distance with the qualification that the range depends upon the environment in which the telephone is used. Many factors limit range, and it would be impossible to include all the variables in our rating. The Maximum Range rating of this phone is meant to be used as a means of comparison against other range claims.

Telephone Line Problems

The FCC has granted the telephone company the right to disconnect service in the event that your phone causes problems on the telephone line. Also, the telephone company may make changes in facilities and services which may affect the operation of your unit. However, your telephone company must give adequate notice in writing prior to such actions to allow you time for making necessary arrangements to continue uninterrupted service.

If you are having trouble with your telephone service, you must first disconnect your phone to determine if it is the cause of your problem. If you determine that it is the cause, you must leave it disconnected until the trouble has been corrected.

Radio Interference

Radio interference may occasionally cause buzzing and humming in your cordless handset, or clicking noises in the base. This interference is caused by external sources such as TV, refrigerator, vacuum cleaner, fluorescent lighting, or electrical storm. Your unit is NOT DEFECTIVE. If these noises continue and are too distracting, please check around your home to see what appliances may be causing the problem.

In addition, we recommend that the base not be plugged into a circuit that also powers a major appliance because of the potential for interference. Be certain that antenna on the unit is fully extended.

In the unlikely event that you consistently hear other voices or distracting transmissions on your phone, you may be receiving radio signals from another cordless telephone or other source of interference. If you cannot eliminate this type of interference, you need to change to a different channel.

Finally, it should be noted that some cordless telephones operate at frequencies that may cause interference to nearby TVs and VCRs. To minimize or prevent such interference, the base of the cordless telephone should not be placed near or on top of a TV or VCR. If interference is experienced, moving the cordless telephone farther away from the TV or VCR will often reduce or eliminate the interference.

More than One Cordless Telephone

If you want to use more than one cordless telephone in your home, they must operate on different channels. Press the delete/channel key to select a channel that provides the clearest communication.

Cordless Telephone Privacy

Cordless telephones are radio devices. Communications between the handset and base of your cordless telephone are accomplished by means of radio waves which are broadcast over the open airways. Because of the inherent physical properties of radio waves, your communications can be received by radio receiving devices other than your own cordless telephone unit. Consequently, any communications using your cordless telephone may not be private.

Installation Considerations

Selecting a Location

Before choosing a location for your new phone, there are some important guidelines you should consider:

- The location should be close to both a phone jack and continuous power outlet. (A continuous power outlet is an AC outlet which does not have a switch to interrupt its power.)
- Keep the base and handset away from sources of electrical noise such as motors or fluorescent lighting.
- The base can be placed on a desk or tabletop or mounted on a standard telephone wall plate.
- You should charge your new phone for 15-20 hours before completing the installation or using the handset.

Telephone Line Outlets

There are two types of phone outlets:

Modular Jack

Most phone equipment available now uses modular jacks. Phone cords are fitted with a molded plastic connector which plugs into this type of jack. If you do not have modular phone jacks, contact your local telephone company for information about their installation.

Hardwired Jack

Some equipment is wired directly to a phone jack, and these types of installations require a modular jack converter. This type of installation is not difficult; however, you should contact your Uniden telephone dealer or a telephone supply store for advice about the proper adapter or converter for your particular situation.

Connecting the Telephone Cords

Consider these safety guidelines before connecting the telephone cords:

Caution!

- *Never install telephone wiring during a lightning storm.*
- *Never touch uninsulated telephone wires or terminals unless the telephone line has been disconnected.*
- *Use caution when installing or modifying telephone lines.*

Applying Power to the Base

This phone requires an AC outlet, without a switch to interrupt power, and the included AC adapter. To relieve strain on the DC plug when the phone is placed on a desk or table, wrap the power cord around the strain relief notch on the back of the base.

NOTE: *Place the power cord so that it does not create a trip hazard, or where it could become chafed and create a fire or other electrical hazards.*

One Year Limited Warranty

Important: Evidence of original purchase is required for warranty service. WARRANTOR: UNIDEN AMERICA CORPORATION ("Uniden")
ELEMENTS OF WARRANTY: Uniden warrants, for one year, to the original retail owner, this Uniden Product to be free from defects in materials and craftsmanship with only the limitations or exclusions set out below.

WARRANTY DURATION: This warranty to the original user shall terminate and be of no further effect 12 months after the date of original retail sale. The warranty is invalid if the Product is (A) damaged or not maintained as reasonable or necessary, (B) modified, altered, or used as part of any conversion kits, subassemblies, or any configurations not sold by Uniden, (C) improperly installed, (D) serviced or repaired by someone other than an authorized Uniden service center for a defect or malfunction covered by this warranty, (E) used in any conjunction with equipment or parts or as part of any system not manufactured by Uniden, or (F) installed or programmed by anyone other than as detailed by the owner's manual for this product.

STATEMENT OF REMEDY: In the event that the product does not conform to this warranty at any time while this warranty is in effect, warrantor will either, at its option, repair or replace the defective unit and return it to you without charge for parts, service, or any other cost (except shipping and handling) incurred by warrantor or its representatives in connection with the performance of this warranty. Warrantor, at its option, may replace the unit with a new or refurbished unit. **THE LIMITED WARRANTY SET FORTH ABOVE IS THE SOLE AND ENTIRE WARRANTY PERTAINING TO THE PRODUCT AND IS IN LIEU OF AND EXCLUDES ALL OTHER WARRANTIES OF ANY NATURE WHATSOEVER, WHETHER EXPRESS, IMPLIED OR ARISING BY OPERATION OF LAW, INCLUDING, BUT NOT LIMITED TO ANY IMPLIED WARRANTIES OF MERCHANTABILITY OR FITNESS FOR A PARTICULAR PURPOSE. THIS WARRANTY DOES NOT COVER OR PROVIDE FOR THE REIMBURSEMENT OR PAYMENT OF INCIDENTAL OR CONSEQUENTIAL DAMAGES.** Some states do not allow this exclusion or limitation of incidental or consequential damages so the above limitation or exclusion may not apply to you.

LEGAL REMEDIES: This warranty gives you specific legal rights, and you may also have other rights which vary from state to state. This warranty is void outside the United States of America and Canada.

PROCEDURE FOR OBTAINING PERFORMANCE OF WARRANTY: If, after following the instructions in the owner's manual you are certain that the Product is defective, pack the Product carefully (preferably in its original packaging). The Product should include all parts and accessories originally packaged with the Product. Include evidence of original purchase and a note describing the defect that has caused you to return it. The Product should be shipped freight prepaid, by traceable means, to warrantor at:

Uniden America Corporation

Parts and Service Division

4700 Amon Carter Blvd. Fort Worth, TX 76155

(800) 297-1023, 8 a.m. to 5 p.m. CST, Monday through Friday

or visit our website at www.uniden.com

I.C. Notice

TERMINAL EQUIPMENT

NOTICE: This equipment meets the applicable Industry Canada Terminal Equipment Technical Specifications. This is confirmed by the registration number. The abbreviation, IC, before the registration number signifies that registration was performed based on a Declaration of Conformity indicating that Industry Canada technical specifications were met. It does not imply that Industry Canada approved the equipment.

NOTICE: The Ringer Equivalence Number (REN) for this terminal equipment is marked on the equipment itself. The REN assigned to each terminal equipment provides an indication of the maximum number of terminals allowed to be connected to a telephone interface. The termination on an interface may consist of any combination of devices subject only to the requirement that the sum of the Ringer Equivalence Numbers of all the devices does not exceed five.

RADIO EQUIPMENT

The term "IC:" before the radio certification number only signifies that Industry Canada technical specifications were met.

Operation is subject to the following two conditions: (1) this device may not cause interference, and (2) this device must accept any interference, including interference that may cause undesired operation of the device. "Privacy of communications may not be ensured when using this telephone".

Index

A

AC adapter information 35

B

Basic setup 13

Battery pack

Information 35

Installing 8

Preparing and charging 8

Replacement and handling 33

Beltclip installation 11

C

Call waiting 20

Caller ID service 28

Call waiting 20

Deleting 30

Making a call 31

Viewing 29

Channel 19

Charging the battery pack 9

Cleaning contacts 34

Connect the base unit 9

Controls and functions 5, 6

D

Dial mode 15

Digital security code 32

E, F, G, H, I, J, K, L

Earpiece volume 18

Find handset 20

General information 35

Headset installation 12

I.C. Notice 41

Installing the phone 7

Interference 40

Liquid damage 38

M, N, O, P, Q

Making a call 17

Package contents 1

Precautions 39

Quick reference guide 1

R

Receiving a call 17

Redial 18

Ringer tone 16

RocketDial 22

S

Speed dial memory

Making calls from speed dial

memory 27

Storing names and numbers in

speed dial memory 23

T, U

Technical information 35

Tone dialing switch-over 19

Traveling out-of-range 19

Troubleshooting 36

V, W, X, Y, Z

Voice mail waiting indicator 21

Wall mounting 10

Warranty 40

Memory List

C U T C U T
MEMORY LOCATION MEMO

Memory Location	Name	Phone Number	Memory Location	Name	Phone Number
1			6		
2			7		
3			8		
4			9		
5			10		

MEMORY LOCATION MEMO

C U T C U T
MEMORY LOCATION MEMO

Memory Location	Name	Phone Number	Memory Location	Name	Phone Number
1			6		
2			7		
3			8		
4			9		
5			10		

MEMORY LOCATION MEMO

Memo

At Uniden, we'll take care of you!

If you need any assistance with this product, please call our Customer Hotline at **1-800-297-1023**
or visit our web site at **www.uniden.com**

PLEASE DO NOT RETURN THIS PRODUCT TO THE PLACE OF PURCHASE.

Our Uniden representatives will be happy to help you with any matters regarding
the operation of this unit, available accessories, or any other related matters.

Thank you for purchasing a Uniden product.
Hours: M-F 8:00 AM to 5:00 PM CST.



For information on the accessibility features of this product, please call
1-800-874-9314 (V/TTY)

Uniden®

May be covered under one or more of the following U.S. patents:

4,523,058	4,595,795	4,797,916	5,381,460	5,426,690	5,434,905
5,491,745	5,493,605	5,533,010	5,574,727	5,581,598	5,650,790
5,660,269	5,661,780	5,663,981	5,671,248	5,696,471	5,717,312
5,732,355	5,754,407	5,758,289	5,768,345	5,787,356	5,794,152
5,801,466	5,825,161	5,864,619	5,893,034	5,912,968	5,915,227
5,929,598	5,930,720	5,960,358	5,987,330	6,044,281	6,070,082
6,125,277	6,253,088	6,314,278	6,418,209		

FOR
ACCESSORIES,
GO ONLINE @
WWW.UNIDEN.COM

REGISTER ONLINE TODAY!
THANK YOU FOR BUYING A UNIDEN PRODUCT.

A World Without Wires | **Uniden®**

Free Manuals Download Website

<http://myh66.com>

<http://usermanuals.us>

<http://www.somanuals.com>

<http://www.4manuals.cc>

<http://www.manual-lib.com>

<http://www.404manual.com>

<http://www.luxmanual.com>

<http://aubethermostatmanual.com>

Golf course search by state

<http://golfingnear.com>

Email search by domain

<http://emailbydomain.com>

Auto manuals search

<http://auto.somanuals.com>

TV manuals search

<http://tv.somanuals.com>