



E X I 7 9 2 6

OWNER'S MANUAL

900 MHz Cordless
Phone

2-Line Operation

Caller ID and
Call Waiting
Operation

Uniden[®]

Introduction

Thank you for choosing the Uniden EXI 7926 cordless telephone. This phone is designed to exacting standards that provide reliability, long life and outstanding performance.

Note: Some illustrations in this manual may differ from the actual unit for explanation purposes.

Features

- 900 MHz Extended Range
- 2-Line Operation with Intercom
- Caller ID and Call Waiting Caller ID
- 80 Number Caller ID Memory
- 40 Number Memory
- 32 Digit Redial
- Flash and Pause
- Pulse / Tone Dialing
- 14 Day Standby Battery Life
- 7 Hour Talk Time
- Handset Earpiece and Ringer Volume Control
- Speakerphone
- 3-Way and 4-Way Conference Operation

Controls and functions

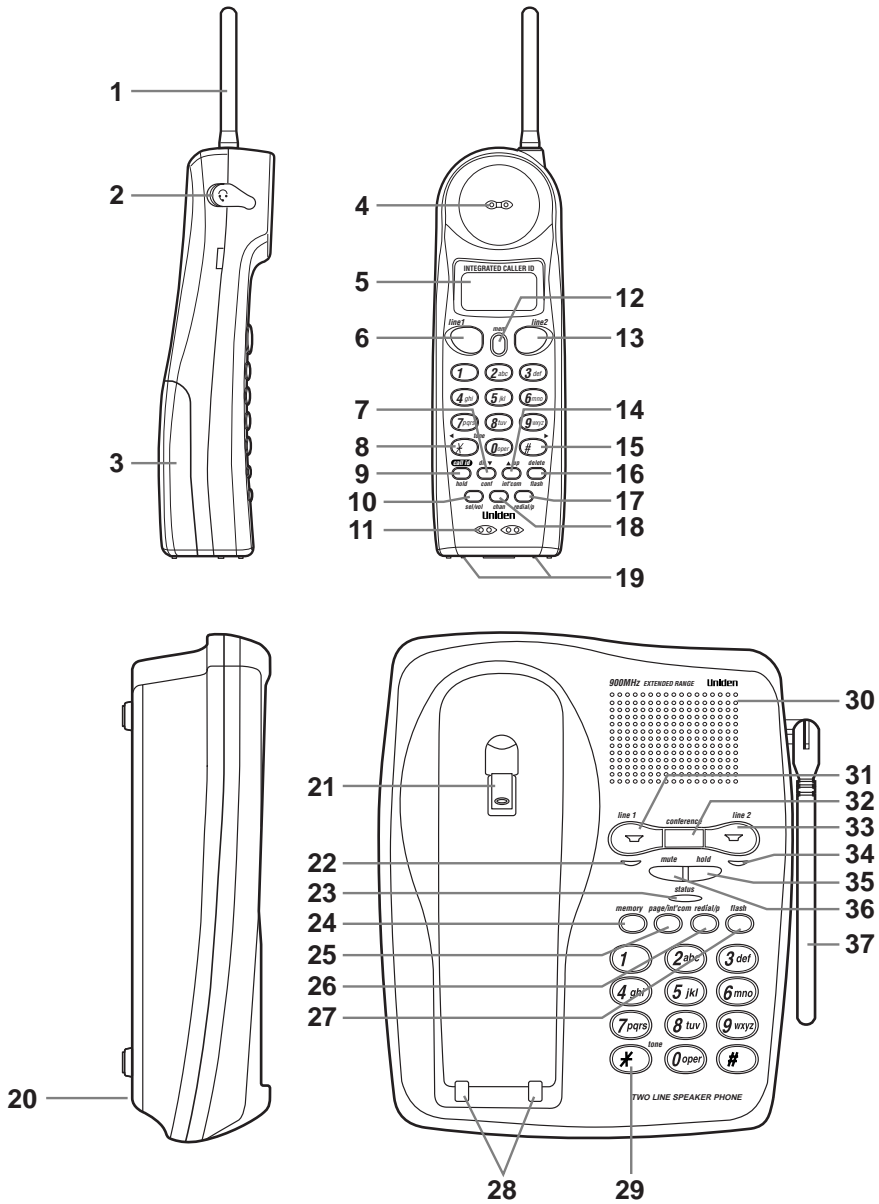

1. Handset antenna
2. Headset jack
3. Handset battery compartment
4. Handset speaker
5. LCD display
6. Line 1 key
7. Cursor down/
Character select/Conference key
8. Tone/Backward key
9. Caller ID/Hold key
10. Select/Volume key
11. Handset microphone
12. Memory key
13. Line 2 key
14. Cursor up/
Character select/Intercom key
15. Cursor forward key
16. Delete/Flash key
17. Redial/Pause key
18. Channel key
19. Handset contact
20. Base microphone
21. Handset clip storage
22. Line 1 status LED
23. Status LED
24. Memory key
25. Page/Intercom key
26. Redial/Pause key
27. Flash key
28. Base contact
29. Tone key
30. Base speaker
31. Line 1 key
32. Conference key
33. Line 2 key
34. Line 2 status LED
35. Hold key
36. Mute key
37. Base antenna
38. Base speaker volume adjust
39. Ring volume switch (2nd line)
40. Ring volume switch (1st line)
41. Pulse-Tone switch
42. DC power input
43. Phone jack (2nd line)
44. Phone jack (1-and 2-line)

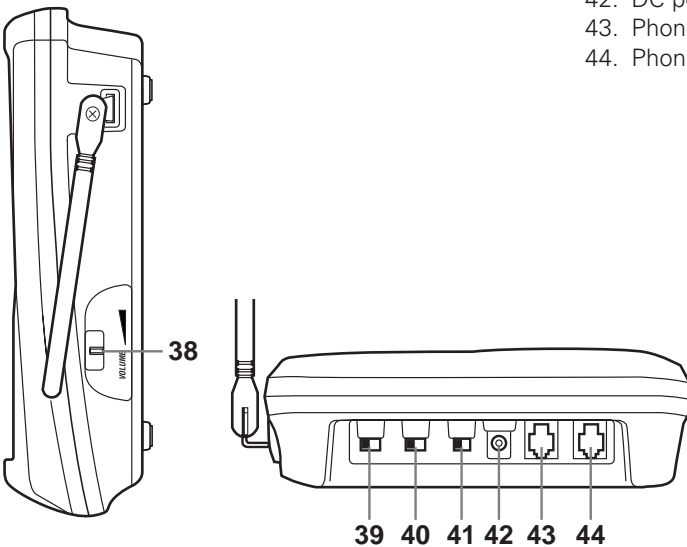

Table of contents

Getting Started

Read this first	6
Step 1: Checking the package contents	7
Step 2: Setting up the base unit	8
Step 3: Preparing the battery pack	11
Step 4: Setting up Caller ID options.....	13
Entering your area code.....	14

Telephone Operation

Basics	15
Making and receiving calls	15
Answering a call from the base.....	16
Answering a call from the handset	16
Making a call from the base	17
Making a call from the handset.....	17
Using the tone feature	17
Flash and Call Waiting	18
Last number redial.....	18
Placing a call on hold	19
Using the speakerphone mute feature.....	19
Using the page feature.....	20
Traveling out-of-range	20
Selecting a different channel.....	20
Adjusting the volume controls.....	20
2-Line features	21
2-Line operation.....	21
3-way conferencing	22
4-way conferencing	23
Using your EXI 7926 intercom.....	24
Transferring calls.....	25
Using the speakerphone.....	25
Memory features	26
Storing a phone number in memory	26
Editing a phone number in memory	28
Erasing a number from memory	30
Using memory dialing.....	32
Caller ID Features	
Using Caller ID.....	33
Using CIDCW (Call ID with Call Waiting).....	37
Additional Information	
Changing the digital security code	38
Headset installation	38
Mounting the base unit on a wall.....	39
Installing the beltclip.....	41
Note on power sources	42
Maintenance	42
Troubleshooting	43
Specifications	44
Index	45

Getting Started

Basics

2-Line
operations

Memory
Features

Caller ID
Features

Additional
Information

Read this first

This cordless telephone must be set up before use. Follow these steps;

Step 1 (page 7)

Unpack the telephone and accessories.

Step 2 (page 8 to 10)

Next, choose the best location to set up the base unit.

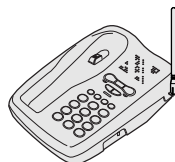

Base unit

Step 3 (page 11 to 12)

Then, insert the battery pack into the handset. You have to charge the battery pack for more than 12-15 hours before using the phone.



Handset

Step 4 (page 13 to 14)

Finally, set Caller ID options and area code in the memory to use the Caller ID service.

Note: Skip the setting of area code if your calling area requires 10 digits dialing.



Handset

About the digital security code

This cordless telephone uses a digital security code to prevent unauthorized access to your base unit. This security code prevents other cordless handsets from making calls through your base unit.

A random security code will be assigned automatically between your base unit and handset when you charge the battery pack for the first time.

To reset the security code, see page 38.

Step 1

Checking the package contents

Make sure you have received the following items in the package.

If any of these items are missing or damaged, contact the **Uniden Parts Department** (see below).

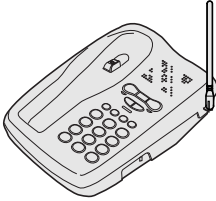

• Base unit



• Handset

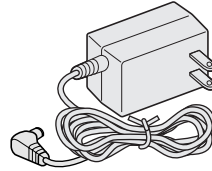

• AC adapter (AD-420)

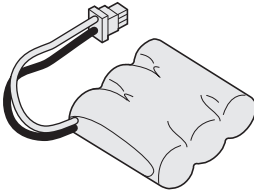

• Rechargeable battery pack (BT-905)

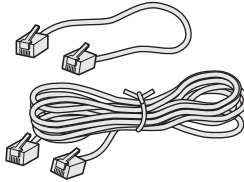

• Telephone line cord (2)

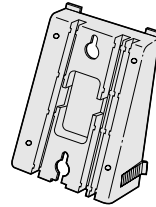

• Wall mount adapter

- This Owner's Manual
- Precautions and Important Safety Instructions
- Registration Card

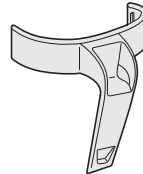

• Beltclip

Uniden Parts Department

(800) 554-3988

Hours are 8:30 a.m. to 5:00 p.m. Central Time, Monday through Friday.

We can also be reached on the web at www.uniden.com.

Step 2

Setting up the base unit

Do the following steps.

- Choose the best location
- Connect the base unit
- Choose the dialing mode

Choose the best location

Before choosing a location for your new phone, read the **INSTALLATION CONSIDERATIONS** included in the **PRECAUTIONS AND IMPORTANT SAFETY INSTRUCTIONS** brochure. Here are some important guidelines you should consider:

Avoid heat sources, such as radiators, air ducts, and sunlight

Avoid television sets and other electronic equipment

Avoid noise sources such as a window by a street with heavy traffic

Avoid microwave ovens

Avoid excessive moisture, extremely low temperatures, dust, mechanical vibration, or shock

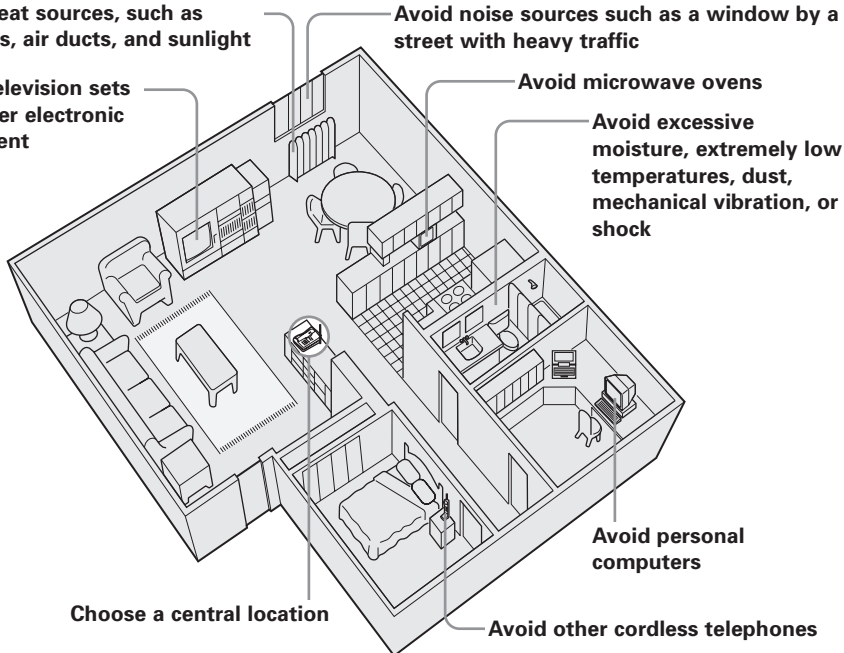

- You should charge your handset for 12-15 hours before using the phone.
- The location should be close to both a phone jack and a continuous a power outlet which is not switchable.
- Keep the base and handset away from sources of electrical noise such as motors and fluorescent lighting.
- Be sure there is sufficient space to raise the base antenna fully vertical.
- The base can be placed on a desk, tabletop or mounted on a standard wall plate.

Step 2 (continued)

Connect the base unit

If you want to install the base unit on the wall, see page 39.

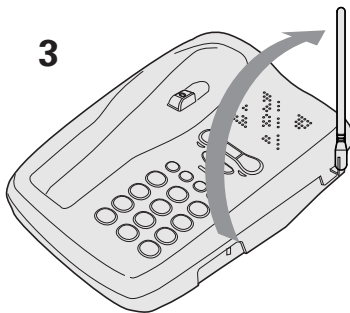
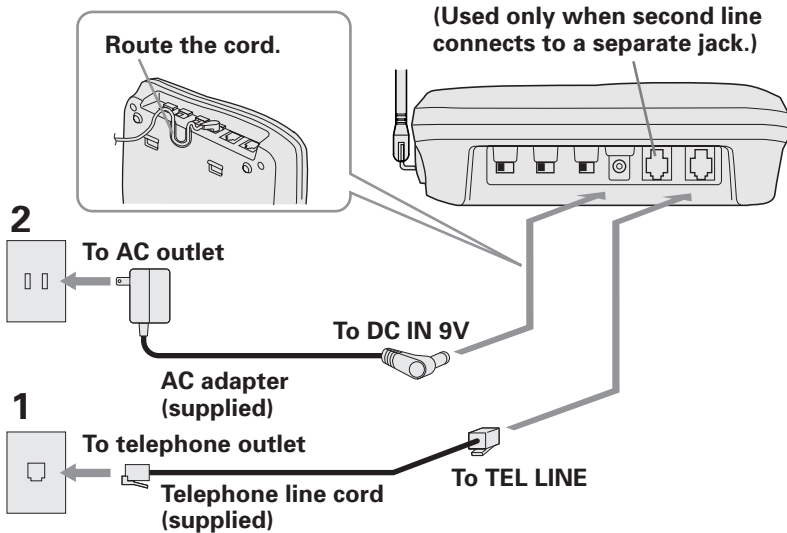

- 1** Connect the telephone line cord to the **TEL LINE** jack and to a telephone outlet.
- 2** Connect the AC adapter to the **DC IN 9V** jack and to a standard 120VAC wall outlet.
- 3** Set base unit on a desk or tabletop and place the handset into the base unit. Then raise the antenna to a vertical position.

Note

Place the power cord so it does not create a trip hazard, or where it could become chafed and create a fire or electrical hazard,

Step 2 (continued)

Notes

- Use only the supplied AD-420 AC adapter.
Do not use any other AC adapter.
- Connect the AC adapter to a continuous power supply.
- Place the base unit close to the AC outlet so that you can unplug the AC adapter easily.

Polarity of the plug

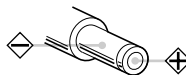

Tips

- If your telephone outlet isn't modular, contact your telephone company for assistance.

Modular



Choose the dialing mode

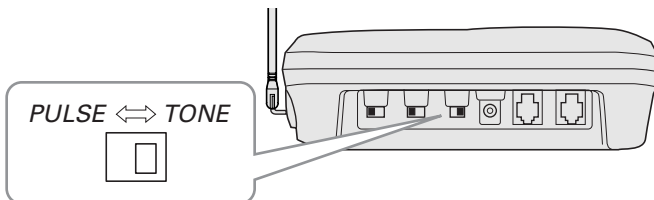

Depending on your dialing system, set the TONE/PULSE switch as follows:

If your dialing system is	Set the switch to
Tone	TONE
Pulse	PULSE

If you aren't sure of your dialing system

Make a trial call with the TONE/PULSE switch set to TONE.

If the call connects, leave the switch as is; otherwise, set to PULSE.

Step 3

Preparing the battery pack

Charge the battery pack for more than 12-15 hours before you start using your phone.

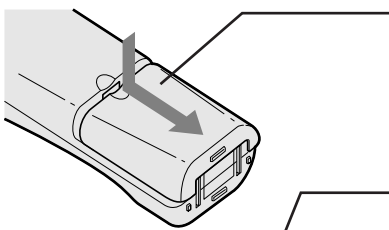

- 1** Press and slide the battery compartment cover toward the bottom of the unit.

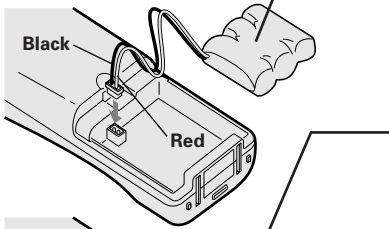

- 2** Connect the battery pack connector. The plug will fit only one way. Then insert the battery pack into the battery compartment.

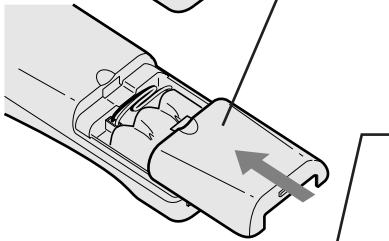

- 3** Securely close the battery compartment cover by sliding it up until it snaps into place.

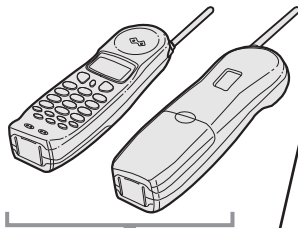

- 4** Place the handset on the base unit with the keys and display facing upward.

When the handset has been properly placed on the charging terminals of the base unit, the "**status**" LED of the base unit lights and charging begins. Charge the battery for at least 12-15 hours.

You can place either side up for charging the battery.

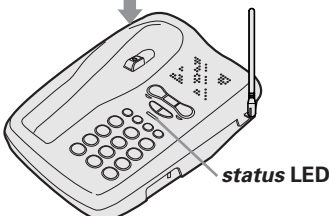

Step 3 (continued)

Battery use time (per charge)

From fully charged.

- Seven hours continuous use.
- Fourteen days when the handset is in the standby mode.

When the battery charge becomes low

When the battery pack is very low and needs to be charged, the phone is programmed to eliminate functions in order to save power. If the phone is not in use, "Low Battery" flashes in the display and none of the keys will operate. If the phone is in use, "Low Battery" flashes and the handset beeps. Complete your conversation as quickly as possible and return the handset to the base unit for charging.



Low Battery

Notes

- Even when the battery pack is not being used, it will gradually discharge over a long period. For optimum performance, be sure to return the handset to the base unit after a telephone call for charging the battery.
- The built-in memory backup can hold numbers and names stored in the memory for up to 2 minutes, while you replace the battery pack.
- If you must replace the battery pack during a telephone call, complete the replacement of the battery pack within 30 seconds, and you can return to the original call.
- Rechargeable batteries have a memory effect that reduces standby and talk time. To avoid this memory effect, on a monthly basis, use the phone until the "Low Battery" indication appears. Then charge the battery for 12-15 hours.

Cleaning the battery contacts

To maintain a good charge, it is important to clean all battery contacts on the handset and base unit about once a month. Use a pencil eraser or other contact cleaner.

Do not use any liquids or solvents.

Step 4

Setting up Caller ID options

There are three Caller ID options available; they are AutoTalk, CIDCW, and Area Code.

AutoTalk allows you to answer the phone without pressing **(line 1)** or **(line 2)**. If the phone rings when AutoTalk is on, simply remove the handset from the base and the phone automatically answers the call. If the phone rings when AutoTalk is off, you must press **(line 1)** or **(line 2)** to answer the call. This option is useful for screening calls.

CIDCW (Caller ID with Call Waiting) performs the same as regular Caller ID on a call waiting number. **You must subscribe to CIDCW from your phone company to use this feature.**

If you enter your 3-digit area code number in the Area Code option, your local area code does not appear in Caller ID messages. When reviewing Caller ID messages, you will see only the local seven digit number. For calls received from outside your local area code, you will see a full 10-digit number.

To change your Caller ID options:

- 1 When the phone is in the standby mode, press and hold **(call id/hold)** until the Caller ID setting screen appears.

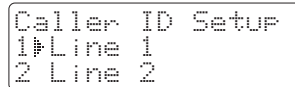
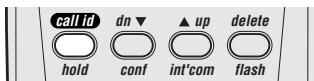

- 2 Press **(▲ up/int'com)** or **(dn ▼/conf)** to select "Line 1" or "Line 2".

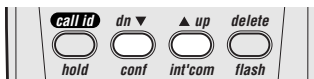

- 3 Press **(sel/vol)**. The following screen appears.

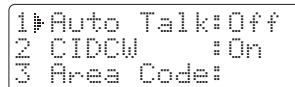

- 4 Press **(▲ up/int'com)** or **(dn ▼/conf)** keys to move the cursor to the selection that you would like to change. Press the **(sel/vol)** key to toggle between "On" and "Off". Press **(sel/vol)**. Use the number keypad to enter or change the area code. Press **(sel/vol)** again.

- 5 After you have made your selections, press **(call id/hold)** or return the handset to the base.

Note If your calling area requires 10-digit dialing do not program this option.

Step 4 (continued)

Entering your area code

Note If your calling area require 10-digit dialing, please skip this step.

You may wish to enter your local area code before you use this phone for the first time, or move to new area code, you should enter your area code.

This is necessary that your phone can distinguish local or long distance calls to properly dial from the Caller ID message list. (See page 33.)

- 1 When the phone is in the standby mode, press and hold **(call id/hold)** until the Caller ID setting screen appears.

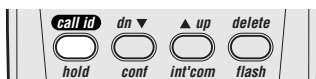

```
Caller ID Setup
1 Line 1
2 Line 2
```

- 2 Press **(up/int'com)** or **(dn/conf)** to select "Line 1" or "Line 2".

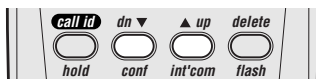

- 3 Press **(sel/vol)**.



```
1 Auto Talk:Off
2 CIDCW      :On
3 Area Code:
```

- 4 Press **(up/int'com)** or **(dn/conf)** to select "Area Code".

```
1 Auto Talk:Off
2 CIDCW      :On
3 Area Code:
```

- 5 Press **(sel/vol)**.

```
1 Auto Talk:Off
2 CIDCW      :On
3 Area Code:█
```

- 6 Use the dial buttons (**0** to **9**) to enter the 3-digit area code.

- 7 Press **(sel/vol)**.

A beep sounds and the displayed area code is entered.

- 8 Press **(call id/hold)** to complete the setting. Or return the handset to the base unit. The phone returns to standby mode.

Note



When the area code has already been stored in memory, the stored area code will be displayed. To change it, use the dial buttons to enter the new area code.

```
1 Auto Talk:Off
2 CIDCW      :On
3 Area Code:817
```

To complete the setting, press **(call id/hold)** or return the handset to the base unit.

Making and receiving calls

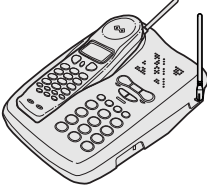
Basic 2-line operation

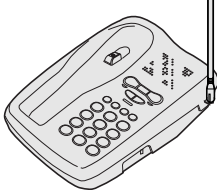
	Handset On Base	Handset Off Base	Base Only
			
To answer a call	<p>Auto Talk off</p> <ol style="list-style-type: none"> Pick up the handset. Press (line 1) or (line 2). <p>Auto Talk on</p> <p>Pick up the handset.</p>	Press (line 1) or (line 2) .	Press (line 1) or (line 2) .
To make a call	<ol style="list-style-type: none"> Pick up the handset. Press (line 1) or (line 2). Listen for the dial tone. Dial the number. 	<ol style="list-style-type: none"> Press (line 1) or (line 2). Listen for the dial tone. Dial the number. 	<ol style="list-style-type: none"> Press (line 1) or (line 2). Listen for the dial tone. Dial the number.
To hang up	Press (line 1) or (line 2) , or return the handset to the base (Auto standby).		Press (line 1) or (line 2) .
To redial	<ol style="list-style-type: none"> Pick up the handset. Press (line 1) or (line 2). Listen for the dial tone. Press (redial/p). 	<ol style="list-style-type: none"> Press (line 1) or (line 2). Listen for the dial tone. Press (redial/p). 	<ol style="list-style-type: none"> Press (line 1) or (line 2). Listen for the dial tone. Press (redial/p).

- Fold out the front cover of this owner's manual to use the Controls and functions diagram for reference.

For clarity, the instructions in this owner's manual designates line 1 unless the procedure requires using line 2. The same instructions apply to line 2. **You must have a 2-line subscription from your phone company to use the 2-line features.**

Answering a call from the base

- 1 The base rings. The corresponding **line 1** LED on the base flashes.
- 2 Press the **(line 1)** button and speak.
- 3 When you finish the call, press **(line 1)** to hang up.

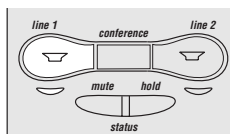
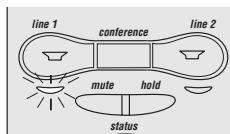

Answering a call from the handset

- 1 The handset rings and the following screen appears:
- 2 Press **(line 1)** to answer your call.
- 3 When you finish the call, press **(line 1)** on the handset, or return the handset to the base.

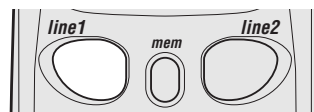
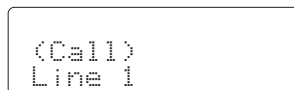

Note If you set the handset in Auto Talk on, and the handset is on the base, just pick up the handset and speak.

Making a call from the base

- 1 Press **(line 1)**.
- 2 Dial the number on the keypad, or, use one of the memory features. (See Using memory dialing, page 32.)
- 3 When you finish the call, press **(line 1)** to hang up.

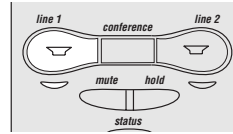

Making a call from the handset

Off-hook dialing

- 1 Pick up the handset.
- 2 Press **(line 1)**.
- 3 Dial the number on the keypad. Or use one of the memory features. (See Using memory dialing, page 32.)
- 4 When you finish the call, press **(line 1)** or, return the handset to the base.

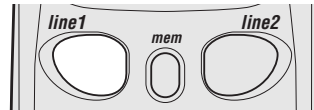

On-hook dialing

To call a number while the handset is in standby mode, dial the number on the keypad, or use one of the memory features. Press **(line 1)**. (See Using memory dialing, page 32.)

Hint AutoStandby automatically hangs up when you place the handset on the base. There is no need to press **(line 1)** or **(line 2)** to hang up.

Note If a line is in use, or a phone off the hook, the LCD screen reads "In Use Line 1".

Using the tone feature

If you are dialing in the pulse mode and need to enter tone digits, press **(* / tone)** then enter the digits. Once the call has ended, tone mode is canceled and pulse dialing resumes.



Note The tone feature applies only when the base is set to pulse.

Flash and Call Waiting

The flash function on the base and handset are independent of each other. If you have Call Waiting service and a call waiting tone sounds, press **flash** (or **delete/flash** on the handset) to accept the call. After a short pause you will hear the new caller. To return to the original caller, press **flash** (or **delete/flash** on the handset) again.

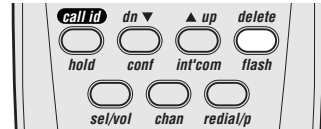

Note The flash feature does not function when **line 1** and **line 2** are on a conference call. (See 3-way conferencing and 4-way conferencing, pages 22 and 23.)

Last number redial

The redial key redials the last number dialed. The redialed number can be up to 32 digits long.

1 Handset

Press **line 1** or **line 2**, then press **redial/p**. Or press **redial/p**, then press **line 1** or **line 2**.

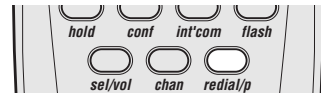

2 Base

Press **line 1** or **line 2**, then press **redial/p**.

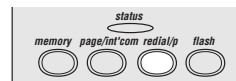

- If any key is pressed before **redial/p**, the last number will not redial.

Tip The EX1 7926 has two independent last number redial memories; one in the handset, the other in the base.

Placing a call on hold

Use either the keypad on the handset or the keypad on the base.

1 To place **line 1** on hold at the base, press **(hold)**. The **line 1** LED turns from green to red.

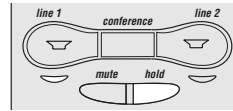

2 To place **line 1** on hold at the handset, press **(call id/hold)**.

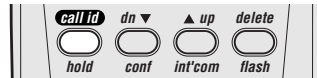

The following screen appears:

3 To pick up the call that is holding, press **(line 1)** on the base or handset.

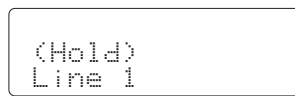

Note Do not use the base and the handset keypads at the same time to place a call on hold.

Using the speakerphone mute feature

Your EXI 7926 allows you to mute your conversation from the base. This prevents the party you are speaking to from hearing what you, or someone else in the room, is saying.

For example, to use this privacy feature while using line 1.

1 Press **(mute)**. The **line 1** LED flashes red.

- You can hear the party on line 1, but they cannot hear you.

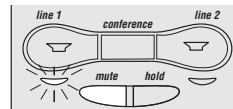

2 When you are ready to continue your conversation with the party on line 1, press **(mute)** again. The **line 1** LED changes to green.

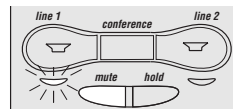

Note • If a line is in use, or a phone off the hook, the LCD screen reads "In Use Line 1 (or Line 2)".

Using the page feature

To locate the handset when it is off the base, press **(page/int'com)** on the base. The handset beeps for 60 seconds. The following screen appears:



Press **(▲ up/int'com)** on the handset to connect to the base. Press **(▲ up/int'com)** on the handset or **(page/int'com)** on the base again to return to standby.

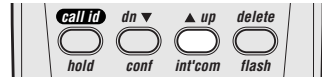

Traveling out-of-range

As you begin to move too far from the base, you first hear a clicking sound. As you travel further, the noise increases. If you travel out-of-range, your call terminates.

Selecting a different channel

If you encounter interference while using your phone, you can manually change the channel for clearer operation. This function works only when the phone is use.

The **(chan)** button on the handset allows you to choose between 40 different channels. During the course of a conversation, if you hear static or noise which marks it difficult to hear, press **(chan)**. The following screen appears and the phone changes to a different channel.

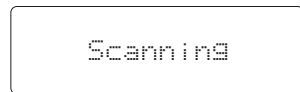

Adjusting the volume controls

Handset ringer volume

When the phone is in standby mode, press the **(sel/vol)** key on the handset to set the handset ringer volume.



Ringer: High ← **(sel/vol)** → Ringer: Low

Handset earpiece volume

During the conversation mode, press **(sel/vol)**. Each time **(sel/vol)** is pressed, the earpiece volume selection changes.

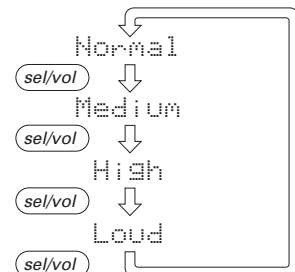

Basics (continued)

Base ringer volume

The ringer control for the base of your EXI 7926 allows you turn the ringer **OFF** or to select **LO/HI** volume for each **line 1** or **line 2**.

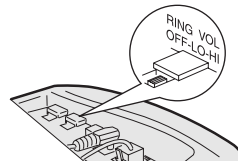

Base speaker volume

To control the speaker volume of the base, adjust the **VOLUME** slide switch as desired.

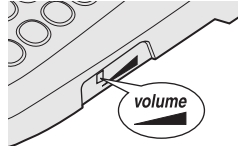

2-Line features

2-Line operation

The handset and the base can be used on separate telephone lines at the same time. For example, if the handset is on a call with **line 1**, you can make, or receive calls at the base on **line 2**.

The **line 1** LED on the base flashes green to indicate line 1 is In Use at the handset.

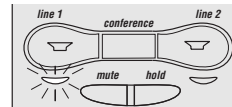

When line 1 is In Use at the base the LCD screen displays the following:

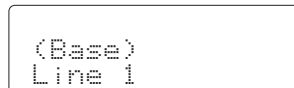

Note When you attempt to make a call, the EXI 7926 informs you if a line is currently In Use.

Extension In Use

The Extension In Use feature prevents accidental interruption of ongoing telephone conversations.

- If you attempt to make a call and another phone is In Use on line 1, the handset LCD indicates an extension is In Use. (The **line 1** LED at the base blinks.) If you press **line 1**, you will hear a beep. This warns you the line is In Use. To make your call, you must use **line 2**.

- Notes**
- If you want to join a conversation on an extension currently In Use, press **(line 1)** or **(line 2)** twice.
 - The flash feature does not function when the phone is in the conference mode.

2-Line features (continued)

3-way conferencing

This feature lets you add a third party to your conversation from either the handset or the base.

For example, to add a party to the current call on **line 1** at the base:

- 1 Press **(hold)** to place the caller on hold. The **line 1** LED turns from green to red.
- 2 Press **(line 2)**.
- 3 Dial the number of the person you want to add to the conversation. When the person answers, you can speak privately before bringing the original caller back on the line.
- 4 Press the **(conference)** button to bring the original call back on line. The **line 1** and **line 2** LEDs are green.

- If the third person's number is busy or doesn't answer, press **line 2** to hang up. Return to the original call by pressing **line 1**.

- 5 To remove either caller from your conversation, ask one of the parties to hang up. Press the corresponding line button to end the call.
- Follow steps 1-5 to conference using the handset. When you return the handset to the base, all calls are disconnected.

Note The flash feature does not function when the phone is in conference mode.

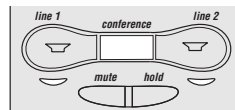
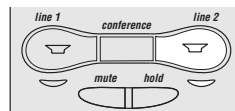
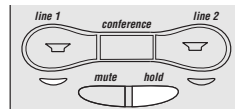

2-Line features (continued)

4-way conferencing

A fourth person, at either the handset or the base, may be added to conference call.

For example, to add a fourth party at the handset to an ongoing conference call at the base:

- 1 Press **(hold)**. The **line 1** and **line 2** LEDs turn red.
- 2 Press **(page/int'com)** on the base to contact the handset.
- 3 Press **(▲ up/int'com)** on the handset. Speak to answer the page.
- 4 Press **(conference)** at the base or **(dn▼/conf)** at the handset to bring the party at the handset in on the call. The **line 1** and **line 2** LEDs are green.

The following screen appears:

- 5 To remove either caller from your conversation, ask one of the parties to hang up. Press the corresponding line button to end the call.

Tips

- When a call is on hold at the handset, and the base is paged, the base will ring even when the **RING VOL** switch is set to **OFF**.
- The person at the handset can join the conversation by pressing the line number currently in use.

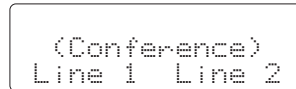
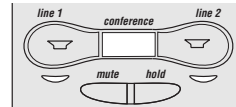
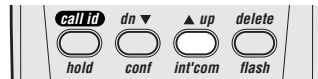
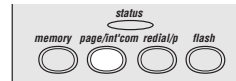
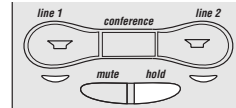
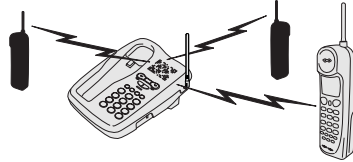

Using your EXI 7926 intercom

Paging from the base to handset

- 1 Press **(page/int'com)** on the base.
The handset beeps. (If no answer, press **(page/int'com)** on the base again to disconnect.)

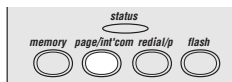

- 2 Press **(▲ up/int'com)** on the handset.
Speak into the mouthpiece to answer the page.

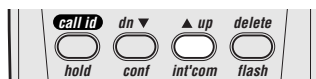

- 3 To turn off the intercom, press **(page/int'com)** on the base or **(▲ up/int'com)** on the handset.

Paging from the handset to base

- 1 Press **(▲ up/int'com)** on the handset.
(If no answer, press **(▲ up/int'com)** on the handset to disconnect.)

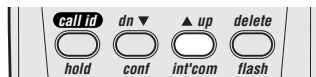

- 2 At the base, press **(page/int'com)**.
Speak into the base microphone to answer the page.

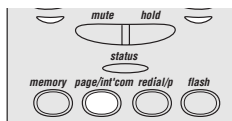

- 3 To turn off the intercom, press **(page/int'com)** at the base or **(▲ up/int'com)** on the handset.

2-Line features (continued)

Transferring calls

- 1 To transfer a call from the base or the handset, press **(hold)** then **(page/int'com)**.

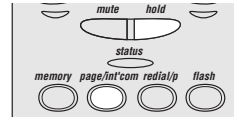

- 2 Answer by pressing **(page/int'com)**. On the base the **status** LED flashes and **line 1** LED turns red.

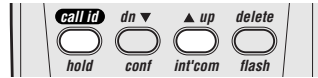

The following screen appears:

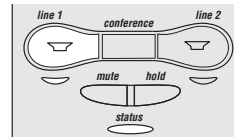

You may then announce the call with the intercom.

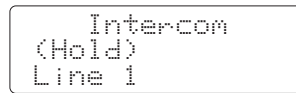

- 3 To speak to the caller, press **(line 1)** or **(line 2)**.

- If no one is available to take the call, return to the caller by pressing **(line 1)** or **(line 2)** to take a message or complete the call.

Using the speakerphone

You may use the phone as speakerphone to answer calls by pressing the **line 1** or **line 2** button on the base. To hang up, press **line 1** or **line 2** again.

The base microphone is located under the phone. Position yourself approximately 12 inches away from the base and speak clearly.

If the handset is on the base, you may use either the base keypad or memory dialing to place a call.

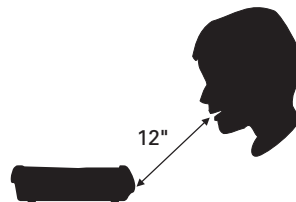

Memory features

Storing a phone number in memory

Your EX1 7926 stores up to 30 name/numbers in the handset plus 10 numbers in the base. Memory locations are shared by both lines.

On the handset

- 1 Pick up the handset from the base.
- 2 Press and hold **(mem)** for two seconds. The following screen appears:

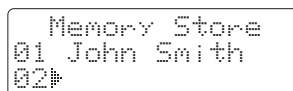
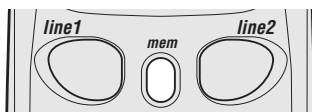

- 3 Use the **(▲ up/int'com)** and **(dn▼/conf)** keys, or number keypad, to choose the memory location to store a name/number.

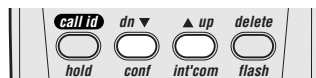

- 4 Press **(sel/vol)**. The following screen appears:

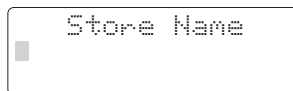

- 5 Enter a name by using the **(▲ up/int'com)** and **(dn▼/conf)** keys to scroll through the character menu. Use the **(*/◀/tone)** and **(#/▶)** keys right or left, or to create a blank space. (The **(delete/flash)** key deletes characters as the cursor moves left.)



- 6 When you have finished entering a name, press **(sel/vol)**. The following screen appears. The cursor flashes, indicating that the display is ready for a number to be entered.

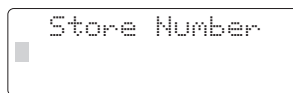

continued next page

Note Whenever you are using a menu screen, you must press a key within 20 seconds or the phone will return to standby. You may also press **(mem)** to exit a memory menu at any time.

Memory features (continued)

continued from previous page

- 7 Enter the phone number with the number keypad. If you want to change the entered number, press **(delete/flash)** and the cursor will move one space to the left and delete that number.

Note When entering name/numbers, you may press **(redial/p)** to enter a pause in the dialing sequence. The display shows a "P". The pause feature is useful for long distance calling, credit card dialing, or any other dialing sequence requiring a pause between digits.

- 8 When you have finished entering a name/number, press **(sel/vol)**. The handset beeps and displays a confirmation screen.

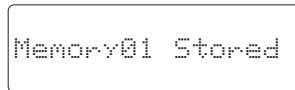

On the base

- 1 Press **(memory)**. The **status** LED blinks.
- 2 Dial the number you wish to store.
- 3 Press **(memory)**. Enter the memory location number (0-9) on the keypad. The **status** LED goes out. A confirmation beep indicates the number is stored.

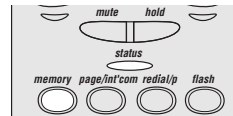
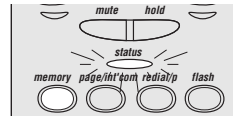

Memory features (continued)

Editing a phone number in memory

To edit a number you have stored in the handset:

- 1 Pick up the handset from the base.
- 2 Press and hold **(mem)** for two seconds.
The display shows the "Memory Store" screen and any saved name/numbers.

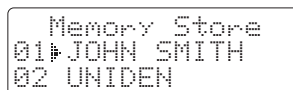
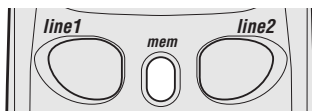

- 3 Use the **(▲ up/int'com)** and **(dn▼/conf)** keys, or number keypad, to select the memory location you would like to edit.

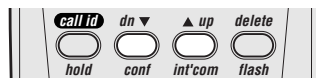

- 4 Press **(sel/vol)**. The display shows the memory location you have selected.

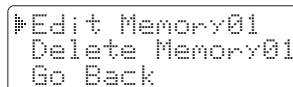

- 5 Press **(sel/vol)** again to enter the "Edit Memory" mode.

- 6 Press **(sel/vol)**. The following screen appears, and a cursor flashes indicating that the display is ready to edit the name.

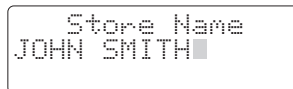

- 7 Enter the name with the **(▲ up/int'com)** and **(dn▼/conf)** keys.
Use the **(▲ up/int'com)** and **(dn▼/conf)** keys to enter symbols.
Use the **(*/←/tone)** and **(#/→)** keys to move the cursor left and right.

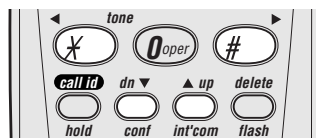

Press **(delete/flash)** to remove any unwanted character.

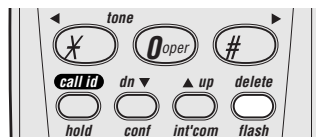

continued next page

Memory features (continued)

continued from previous page

- 8 Press **(sel/vol)**. The following screen appears. A cursor flashes indicating that the display is ready for the number to be edited.

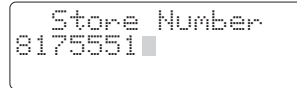

- 9 Enter the phone number with the number keypad (direct entry).

Press **(delete/flash)** to remove any unwanted character.

Press and hold **(delete/flash)** to clear the entire number.

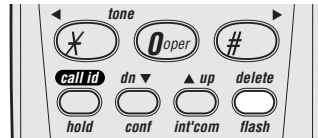

- 10 Press **(sel/vol)**. The handset beeps and displays the confirmation screen.

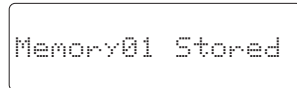

- 11 The display then returns to the "Memory Store" screen. You may select another number to edit (return to step 3) or press **(mem)** to return to standby.

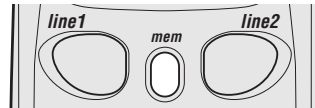

Notes

- Whenever you are using a menu screen, you must press a key within 20 seconds or the phone will return to standby. You may also press **(mem)** to exit a memory menu at any time.
- If you select "Go Back" at any time, no changes are made and the handset shows the "Memory Store" screen.

Memory features (continued)

Erasing a number from memory

After erasing a number, you may add a new address to memory.

From the handset

- 1 Pick up the handset from the base.
- 2 Press and hold **(mem)** for two seconds.
The handset shows the "Memory Store" screen with saved name/numbers displayed.

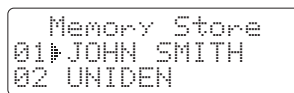
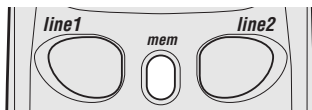

- 3 Use the **(▲ up/int'com)** and **(dn ▼/conf)** keys, or number keypad, to select the memory location you would like to delete.
The **(*/▲/tone)** and **(#/#/▶)** keys toggle between the name display and the number display.

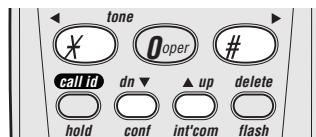

- 4 Press **(sel/vol)**. The following screen appears:

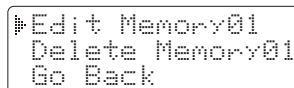

- 5 Use the **(dn ▼/conf)** key to move the ▶ cursor to "Delete Memory".

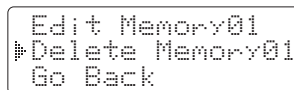

- 6 Press **(sel/vol)**.

- 7 Use the **(▲ up/int'com)** key to move the ▶ cursor to "Yes".

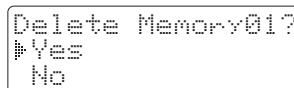

continued next page

Notes

- If you select "Go Back" at any time, no changes are made and the handset shows the "Memory Store" screen.
- If you select "No", no changes are made. The handset shows the "Memory Store" screen.

Memory features (continued)

continued from previous page

- 8 Press **(sel/vol)**. There is a confirmation tone, and the following screen appears:

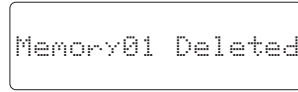

- 9 The display then returns to the "Memory Store" screen. You may select another number to delete (return to step 3) or you may press **(mem)** to return to standby.

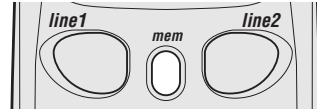

From the base

- 1 Press **(memory)**. The **status** LED blinks.

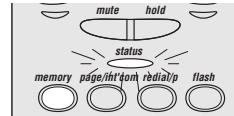

- 2 Press **(memory)** again. Enter the memory location (0-9) of the number you wish to delete. The **status** LED goes out. A confirmation beep indicates the number has been erased.

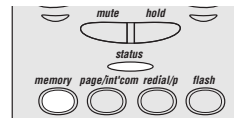

Memory features (continued)

Using memory dialing

Follow the steps below to dial a number using a programmed memory location:

From the handset

- 1 Press **mem**. The handset displays your programmed memory locations.

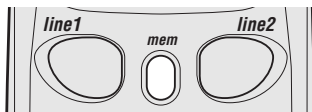

```
01  
02 JOHN SMITH  
03 UNIDEN
```

- 2 Use the **▲ up/int'com** and **dn▼/conf** keys to select the memory location you would like to dial. The following screen appears:

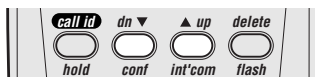

```
01  
02 JOHN SMITH  
03 UNIDEN
```

- 3 Press **line 1**. The number dials.

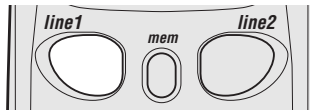

At the base

- 1 Press **line 1**. The **line 1** LED lights.

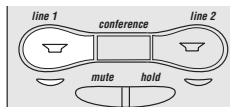

- 2 Press **memory**. Enter the memory location number (0-9), to dial the number.

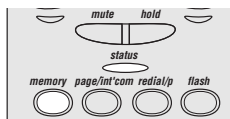

Caller ID features

Using Caller ID

You must subscribe to Caller ID from your phone company to use this feature.

Screening your calls

Caller ID allows you to review caller information before answering your phone.

At the second ring, the display shows the date, time, call count, name and phone

number of the caller. If your Caller ID service is number only, the name does not appear on the second line.

```
12/21 12:30PM 03
Schlitz Maren
817-555-1212
```

If a name or number is not available, the display shows a message such as "Incomplete Data", "Private Number", "Private Name", etc.

Reviewing Caller ID name/numbers

To review your Caller ID name/numbers, follow the steps below:

- 1 Press **call id/hold**. The following screen appears:

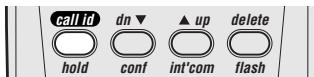

```
                New Total
Line1  00  02
Line2  01  01
```

- 2 Use **up/int'com** or **dn/conf** to select "Line 1" or "Line 2" for caller ID.

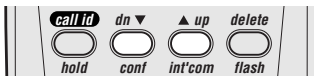

- 3 Press **sel/vol** to display the latest Caller ID message for that line.



```
12/21 12:30PM 03
Schlitz Maren
817-555-1212
```

- 4 Press **up/int'com** to see the next message. Or press **dn/conf** to see previous message.

- 5 Once you have reviewed your oldest name/number, the following screen appears.

```
-End of List-
```

continued next page

Notes

- If you have no Call ID name/ numbers, then the total is shown as "00".
- Once a Caller ID message has been viewed, it is no longer considered a new message.

Caller ID features (continued)

continued from previous page

- 6** Press **(call id/hold)** to return to standby.



Note Once you have viewed all of your Caller ID name/numbers and reach the "End of List" display, the message list does not cycle back to the beginning. You must press **(▲ up/int'com)** to view your previous name/numbers.

Calling a Caller ID name/number

- 1** Press **(call id/hold)**. The Caller ID summary screen shows the number of new callers and total number of calls.



```
                New Total
Line1  00  02
Line2  01  01
```

- 2** Use **(▲ up/int'com)** or **(dn ▼/conf)** to select "Line 1" or "Line 2" caller ID.

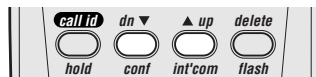

- 3** Press **(sel/vol)** to display the caller ID message.



- 4** Press **(dn ▼/conf)** to scan forward.
Press **(▲ up/int'com)** to scan backwards through the list.

- 5** Select the name/number that you would like to dial.

```
12/21 12:30PM 03
Schlitz Maren
817-555-1212
```

- 6** Press **(line 1)**. The number automatically dials.

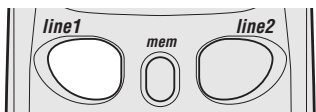

Note For long distance calling, insert "1" by pressing **(1)** on the keypad before pressing **(line 1)**.

Caller ID features (continued)

Storing a Caller ID number in a memory location

- 1 Press **(call id/hold)**. The Caller ID summary screen shows the number of new callers and total number of calls.

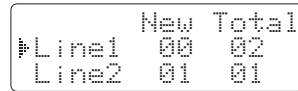
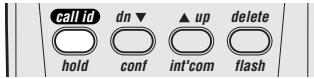

- 2 Use **(▲ up/int'com)** or **(dn ▼/conf)** to select "Line 1" or "Line 2" caller ID.

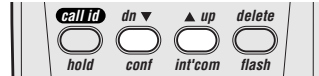

- 3 Press **(sel/vol)** to display the caller ID message.



- 4 Press **(▲ up/int'com)** or **(dn ▼/conf)** to find the name/number that you would like to store.

- 5 Press **(mem)** to store the selected message. The following screen appears:

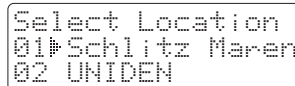
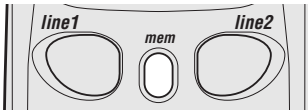

- 6 The "Select Location" screen appears. Use the **(▲ up/int'com)** and **(dn ▼/conf)** keys to select a blank memory location where you would like to store the number. (If you want to replace an existing number with the Caller ID number, skip to step 6.)

- 7 Press **(sel/vol)**. A confirmation tone sounds. The number is programmed.

- 8 If you choose to replace an existing number with the Caller ID number, press **(sel/vol)**. The following screen appears:

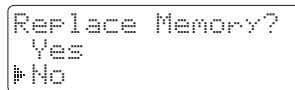

- 9 Use the **(▲ up/int'com)** key to move the cursor to "Yes". Press **(sel/vol)**. A confirmation tone sounds. The number is programmed.

Note If you select "No", then the Caller ID screen returns.

Caller ID features (continued)

Deleting a Caller ID message

To delete a single Caller ID message, follow the steps below.

- 1 Press **(call id/hold)**. The Caller ID summary screen shows the number of new callers and total number of calls.

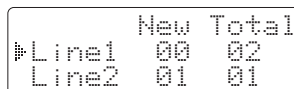
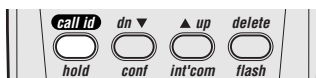

- 2 Use **(▲ up/int'com)** or **(dn ▼/conf)** to select "Line 1" or "Line 2" caller ID.

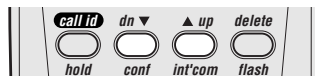

- 3 Press **(sel/vol)** to display the caller ID message.



- 4 Select the number that you would like to delete. Press **(▲ up/int'com)** or **(dn ▼/conf)** to find the name/number that you would like to.

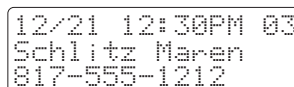

- 5 Press **(delete/flash)**. The following screen appears:

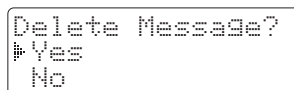
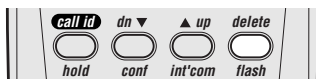

- If you select "No", the Caller ID screen returns.

- 6 Press **(sel/vol)** or **(delete/flash)**. A confirmation tone sounds. The Caller ID screen returns with the next name/number displayed.

- 7 Press **(call id/hold)** to return to standby.

Caller ID features (continued)

Deleting all Caller ID name/numbers

To delete all of your Caller ID messages, follow the steps below.

- 1 Press **call id/hold**. The Caller ID summary screen shows the number of new callers and total number of calls.



```
New Total
Line1 00 02
Line2 01 01
```

- 2 Use **▲ up/int'com** or **dn▼/conf** to select "Line 1".

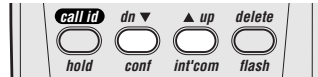

- 3 Press **delete/flash** to delete name/numbers on **line 1**. The following screen appears:

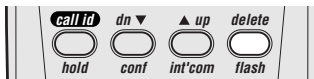

```
Del All, Line 1?
Yes
No
```

- 4 Use the **▲ up/int'com** key to move the cursor to "Yes".

- 5 Press **delete/flash** or **sel/vol**. A confirmation tone sounds. The following screen appears:

```
New Total
Line1 00 00
Line2 00 01
```

- 6 Use **dn▼/conf** to select **line 2**.

- 7 Repeat steps 3 through 6.

```
New Total
Line1 00 00
Line2 00 00
```

All your caller ID messages are deleted.

Using CIDCW (Caller ID with Call Waiting)

- 1 During a call, when you hear the Caller ID tone, check the handset display for the name and number of incoming calls.

```
12/21 12:30PM 03
Schlitz Maren
817-555-1212
```

- 2 Press **delete/flash** to accept the incoming call. See Flash and Call Waiting, page 18.



Additional information

Changing the digital security code

The digital security code is an identification code used to connect the handset and the base unit. Normally, setting the code is not necessary.

The first time you charge your handset, the security code is automatically set. (See page 6.)

In the rare situation that you suspect another cordless telephone is using the same security code, you can change the code.

1 Remove the handset from the base unit.
Press **page/int'com**.

2 While the handset is beeping, place the handset in the base unit.

The paging tone stops. Leave the handset on the base at least 3 seconds.
A random, new security code is set.

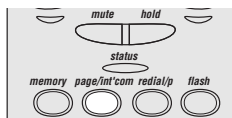

Note

If the handset battery pack is completely discharged, or the battery pack removed, the digital security code will be lost.

If this happens, a new security code is set automatically the next time the battery pack is charged.

Headset installation

Your phone may be used with an optional headset, the Uniden HS910. To use this feature, insert headset plug into the headset jack. Your phone is ready for hands-free conversations.

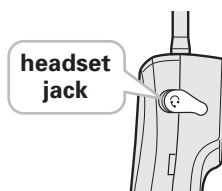

If you are using an optional headset, you must still use the handset keypad for phone operations.

Use only Uniden HS910 headset specifically designed for Uniden phones.

Additional information

Mounting the base unit on a wall

Standard wall plate mounting

This phone can be mounted on any standard telephone wall plate.

1

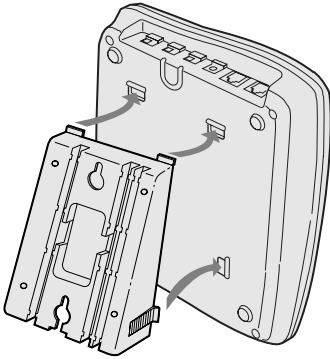

1

Snap the wall mount adapter into the notches on the base.

2, 3, 4,
5, 6, 7

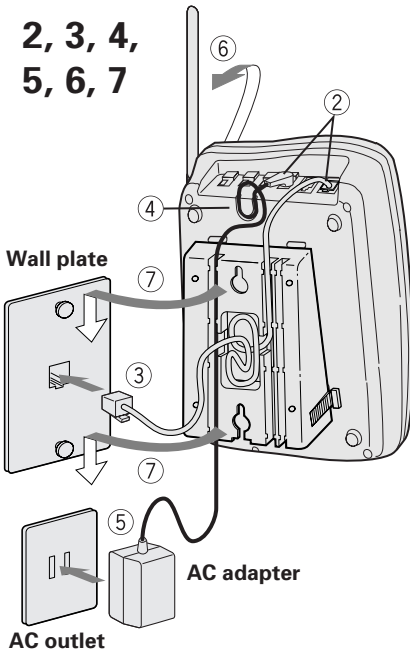

2

Plug the telephone line cord to the **TEL LINE** jack and the AC adapter to the **DC IN 9V** jack.

3

Plug the telephone line cord into the telephone outlet.

4

Wrap the AC adapter cord inside the molded wiring channel. Then wrap the cord around the strain relief notch.

5

Plug the AC adapter into a standard 120VAC wall outlet.

6

Raise the antenna to a vertical position.

7

Align the mounting slots on the base with the mounting posts on the wall. Push in and down until the phone is firmly seated.

Additional information

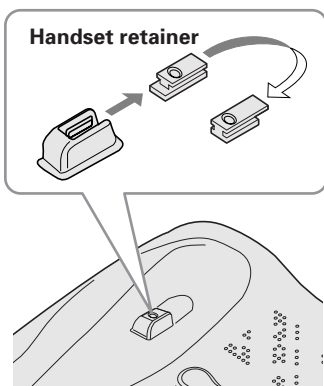

- 8 On the base unit, pull the handset retainer out of the slot. Rotate it clockwise 180 degrees.
- 9 Flip the retainer from front to back. Slide it back into the slot so that the lip of the retainer is up and the oval is down. The retainer holds the handset in place.

Direct wall plate mounting

If you don't have a standard wall plate, you can mount your phone directly to the wall. Before doing this, consider the following:

- Avoid electrical cables, pipes, or other items behind the mounting location, that could cause a hazard when inserting screws into the wall.
- Try to mount your phone within 10 - 15 feet of a working phone jack to avoid excessive cord lengths.
- Make sure the wall material is capable of supporting the weight of the base and handset.

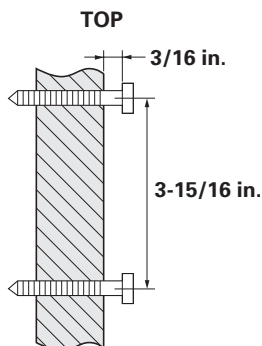

- 1 Insert two mounting screws into the wall, (with their appropriate anchoring device), $3-15/16$ inches apart. Allow about $3/16$ of an inch between the wall and screwheads for mounting the phone.
- 2 Refer to steps 1 through 9 on page 39 to mount the telephone.

Installing the beltclip

To attach the beltclip

Insert the beltclip into the holes on each side of the handset. Press down until it clicks.

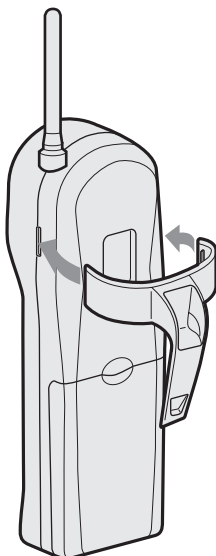

To remove the beltclip

Pull both sides of the beltclip to release the tabs from the holes.

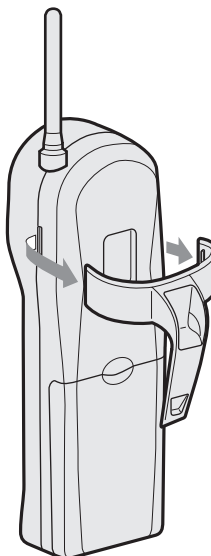

Note on power sources

Battery replacement and handling

When the operating time becomes short, even after a battery is recharged, please replace the battery.

With normal usage, your battery should last about one year.

Please contact your place of purchase for a replacement battery.

Power Failure

During the period that the power is off, you will not be able to perform or receive calls with the telephone.

RECYCLING NICKEL-CADMIUM BATTERIES

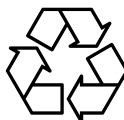

NICKEL-CADMIUM BATTERIES MUST BE DISPOSED OF PROPERLY.

Ni-Cd

Nickel-cadmium cells are used in the battery pack. Please take your used nickel-cadmium battery packs to a store that recycles nickel-cadmium batteries.

Caution

- Use the specified battery pack.
- Do not remove the battery from the handset to charge it.
- Never throw the battery into a fire, disassemble it, or heat it.
- Do not remove or damage the battery cover.

Maintenance

When slightly dirty

Wipe with a soft, dry cloth.

When very dirty

Use a pencil eraser that has been dampened with diluted, neutral detergent. Dry with a dry cloth.

When the charging terminals become dirty

Wipe with a pencil eraser or other contact cleaner.

Caution

Do not use paint thinner, benzene, alcohol, or another chemical product. Doing so may discolor the surface of the telephone and damage the finish.

Additional information

Troubleshooting

If your phone is not performing to your expectations, please try these simple steps before calling Uniden Customer Service at **(800) 297-1023**.

Symptom	Suggestion
The status light won't come on when the handset is placed in the base unit.	<ul style="list-style-type: none">• Make sure the AC adapter is plugged into the base unit and wall outlet.• Make sure the handset is properly seated in the base unit.• Make sure the charging contacts on the handset and base unit are clean.
The audio sounds weak and/or scratchy.	<ul style="list-style-type: none">• Make sure that the base unit antenna is in a vertical position.• Press (chan) on the handset to eliminate background noise.• Move the handset and/or base unit to a different location away from metal objects or appliances and try again.
Can't make or receive calls	<ul style="list-style-type: none">• Check both ends of the base unit telephone line cord.• Make sure the AC adapter is plugged into the base unit and wall outlet.• Disconnect the AC adapter for a few minutes, then reconnect it.• Place the handset back on the charging cradle for a few seconds. The status LED will blink indicating that the security code has been reset.
The handset doesn't ring or receive a page.	<ul style="list-style-type: none">• The battery pack may be weak. Charge the battery on the base unit for 12-15 hours.• The handset may be too far away from the base unit.• Place the base unit away from appliances or metal objects.• Place the handset back on the charging cradle for a few seconds.• The status LED will blink indicating that the security code has been reset.
The Caller ID message disappears.	<ul style="list-style-type: none">• The handset was picked up before the second ring.• The call was placed through a switch board.• Call your local telephone company to verify your Caller ID service is current.

Additional information

Specifications

General

The EXI-7926 complies with FCC Parts 15 and 68.

Frequency control: PLL
Frequency shift keying: FSK
Operating temperature: 0°C to +50°C (+32°F to +122°F)

Base unit

RX frequency: 902.102465 MHz to 904.052470 MHz (40 channel)
TX frequency: 925.997470 MHz to 927.947465 MHz (40 channel)
Power requirements: 9V 350mA (from AC adapter)
Size: 7-3/64 in. (W) x 2-17/64 in. (D) x 8-55/64 in. (H)
(179 mm (W) x 57.6 mm (D) x 225 mm (H))
Weight: Approx. 8.643 oz. (225 g)

Handset

RX frequency: 925.997470 MHz to 927.947465 MHz (40 channel)
TX frequency: 902.102465 MHz to 904.052470 MHz (40 channel)
Power requirements: Rechargeable Nickel-Cadmium battery pack
Size (without antenna): 2-9/32 in. (W) x 1-31/32 in. (D) x 7-1/8 in. (H)
(58 mm (W) x 49.9 mm (D) x 181 mm (H))
Weight: Approx. 8.65 oz. (242 g) (including battery)
Battery: BT-905
Capacity 600 mAh, 3.6V
Talk mode 7 hours TYP
Standby mode 14 days TYP

Specifications, features, and availability of optional accessories are all subject to change without prior notice.

At Uniden, we'll take care of you!

If you need any assistance with this product, please call our Customer Hotline at;

1-800-297-1023

PLEASE DO NOT RETURN THIS PRODUCT TO THE PLACE OF PURCHASE.

Our Uniden representatives will be happy to help you with any matters regarding the operation of this unit, available accessories, or any other related matters.

Thank you for purchasing a Uniden product.
Hours: M-F 7:00 AM to 7:00 PM CST

Index

0 - 9

- 2-Line features
 - 2-Line operation21
 - 3-way conferencing.....22
 - 4-way conferencing.....23
 - Transferring call.....25
 - Using the speakerphone.....25
 - Using your EXI 7926 intercom.....24

A

- Answering a call16
- Area code14

B

- Battery pack
 - Preparing and charging11
 - Replacement and handling42

C

- Caller ID features
 - Deleting all Caller ID name/numbers37
 - Deleting a Caller ID message36
 - Reviewing Caller ID name/numbers33
 - Storing a Caller ID number in a memory location35
 - Using CIDCW (Caller ID with Call Waiting)37
 - Using caller ID.....33
- Connection9

D

- Dialing mode.....10
- Digital security code6,38

E, F, G

- Earpiece volume.....20
- Flash and Call Waiting18

H

- Headset installation38

I, J, K

- Installing the beltclip.....41

L

- Last number redial.....18

M, N

- Maintenance42
- Making a call.....17
- Making and receiving calls15
- Memory features
 - Editing a phone number in memory.....28
 - Erasing a number from memory....30
 - Using memory dialing32
 - Storing a phone number in memory.....26
- Mounting the base unit to a wall39

O

- Out-of-range20

P, Q

- Package contents7
- Paging.....20

R

- Redialing18
- Ringer volume20

S

- Setting up Caller ID options13
- Setup
 - Base unit.....8
 - Handset.....11
- Speaker volume.....20
- Specifications44

T

- Troubleshooting43

U, V, W, X, Y, Z

- Using the speakerphone mute feature.....19
- Using the tone feature17

THANK YOU

FOR PURCHASING A UNIDEN PHONE!

Uniden®

Covered under one or more of the following U.S. patents:

4,511,761 4,523,058 4,595,795 4,797,916

5,426,690

© May 1999 Uniden America Corporation

All rights reserved • Printed in China UC7701216BZ

Free Manuals Download Website

<http://myh66.com>

<http://usermanuals.us>

<http://www.somanuals.com>

<http://www.4manuals.cc>

<http://www.manual-lib.com>

<http://www.404manual.com>

<http://www.luxmanual.com>

<http://aubethermostatmanual.com>

Golf course search by state

<http://golfingnear.com>

Email search by domain

<http://emailbydomain.com>

Auto manuals search

<http://auto.somanuals.com>

TV manuals search

<http://tv.somanuals.com>