



EXI 8966

OWNER'S MANUAL

900 MHz
Cordless Phone
with Caller ID

Advanced Call Waiting
Options

Dual Keypads and Displays

Uniden®

Controls and functions

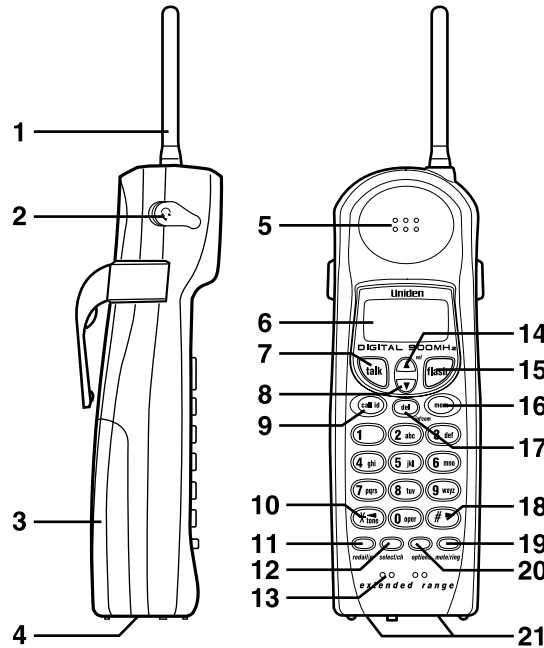

1. Handset antenna
2. Headset jack cover
3. Handset battery compartment
4. Handset ringer switch
5. Handset earpiece
6. LCD display
7. Talk key
8. Volume/Cursor down/character select key
9. Caller ID key
10. Tone/Backspace key
11. Redial/Pause key
12. Select/Channel key
13. Handset microphone
14. Volume/Cursor up/Character select key
15. Flash key
16. Memory key
17. Delete/Intercom key
18. Cursor forward key
19. Mute/Ring key
20. Option key
21. Handset contact
22. Base microphone
23. Handset retainer clip
24. LCD display
25. Status LED
26. One touch dial 1 (m1) key
27. One touch dial 2 (m2) key
28. One touch dial 3 (m3) key
29. One touch dial 4 (m4) key
30. Tone key
31. Base contact
32. Base speaker
33. Base antenna
34. Speaker LED
35. Memory key
36. Delete key
37. Redial key
38. Page/Intercom key
39. Mute key
40. Speaker key
41. Flash key
42. Base speaker volume adjust
43. Base ringer switch
44. Pulse-Tone switch
45. DC power input
46. Phone jack

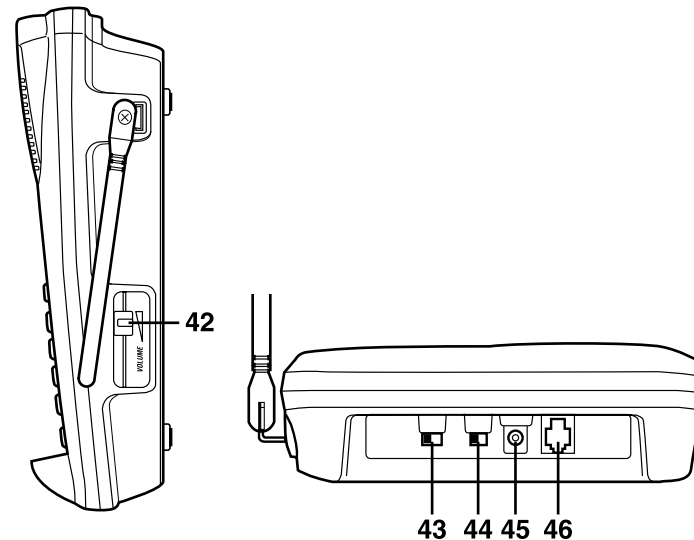
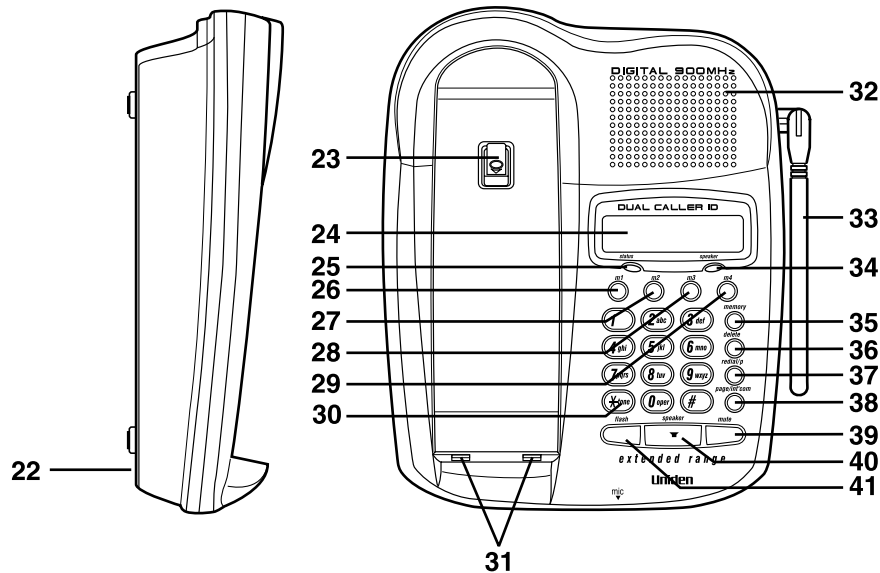

Introduction

Thank you for choosing the Uniden EXI 8966 cordless telephone. This phone is designed to exacting standards that provide reliability, long life and outstanding performance.

Note: Some illustrations in this manual may differ from the actual unit for explanation purposes.

Features

- 900 MHz Extended Range
- Secure Digital Transmission
- Caller ID and Call Waiting Caller ID
- Advanced Caller ID with Call Waiting Option
- 50 Number Caller ID Memory
- 34 Number Memory (20 on the handset and 14 on the base)
- Backlit Display (3 line for the handset and 2 line for the base)
- 3 Redial Memories (32 digit)
- Flash and Pause
- Pulse / Tone Dialing
- 10 Day Standby Battery Life
- 7 Hour Talk Time
- Handset Earpiece and Ringer Volume Control
- Base Speakerphone with Keypad
- 3-Way Conference Operation
- Dual Keypad
- Dual Display

Table of contents

Introduction / Features	inside front cover
Control and Functions.....	inside front cover

Getting Started

Read this first	4
Step 1: Checking the package contents	5
Step 2: Setting up the base unit	6
Step 3: Preparing the battery pack	9
Step 4: Entering your area code	11

Basics

Making calls	12
Making a call with the handset	12
Making a call with the base	14
Redialing a call with the handset	15
Redialing a call with the base.....	16
Receiving calls	17
Receiving a call with the handset	17
Receiving a call with the base.....	19

Telephone Features

Memory storing.....	20
Memory dialing	23
Memory editing.....	26
Memory erasing.....	28
Mute.....	30
3-way conference features	31
Intercom feature	32
Call transfer feature.....	33

Caller ID Features

Caller ID service	34
Setting the Caller ID options	35
When the telephone rings.....	36
Viewing the Caller ID message list	37
Deleting information from the Caller ID list	38
Calling a party from the Caller ID list	40
Storing Caller ID messages in memory	41
Caller ID with call waiting service	42
Call waiting features	43

Additional Information

Changing the digital security code.....	44
Mounting the base unit on a wall	45
Additional Information.....	47
Installing the beltclip.....	47
Headset installation	47
Note on power sources.....	48
Maintenance.....	48

Troubleshooting	49
-----------------------	----

Index	51
-------------	----

Getting Started

Basics

Telephone
Features

Caller ID
Features

Additional
Information

Troubleshooting

Index

Read this first

This cordless telephone must be set up before use. Follow these steps:

Step 1 (page 5)

Unpack the telephone and accessories.

Step 2 (page 6 to 8)

Next, choose the best location to set up the base unit.



Base unit

Step 3 (page 9 to 10)

Then, insert the battery pack into the handset. You have to charge the battery pack for 12-15 hours before using the phone.



Handset

Step 4 (page 11)

Finally, store your area code in the memory to use the Caller ID service, if you do not live in an area that requires 10-digit dialing.



Handset

About the digital security code

This cordless telephone uses a digital security code to prevent unauthorized access to your base unit. This security code prevents other cordless handsets from making calls through your base unit.

A random security code will be assigned automatically between your base unit and handset when you charge the battery pack for the first time.

If you want to reset the security code, see page 44.

Step 1: Checking the package contents

Make sure you have received the following items in the package.
If any of these items are missing or damaged, contact the **Uniden Parts Department** (see below).



• Base unit



• Handset

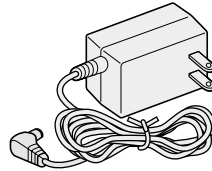

• AC adapter (AD-420)

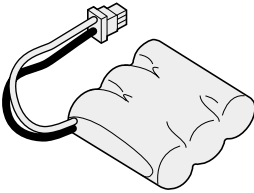

• Rechargeable battery pack (BT-905)

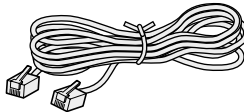

• Telephone line cord

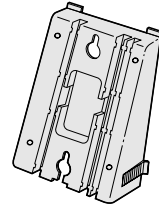

• Wall mount adapter

- This Owner's Manual
- Precautions and Important Safety Instructions
- Registration Card

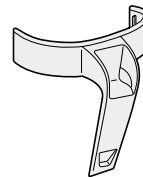

• Beltclip

Uniden Parts Department

(800) 554-3988

Hours are 7:00 a.m. to 5:00 p.m. Central Time, Monday through Friday.

We can also be reached on the web at www.uniden.com.

Step 2: Setting up the base unit

Do the following steps.

- Choose the best location
- Connect the base unit
- Choose the dialing mode

Choose the best location

Before choosing a location for your new phone, read the INSTALLATION CONSIDERATIONS included in the PRECAUTIONS AND IMPORTANT SAFETY INSTRUCTIONS brochure. Here are some important guidelines you should consider:

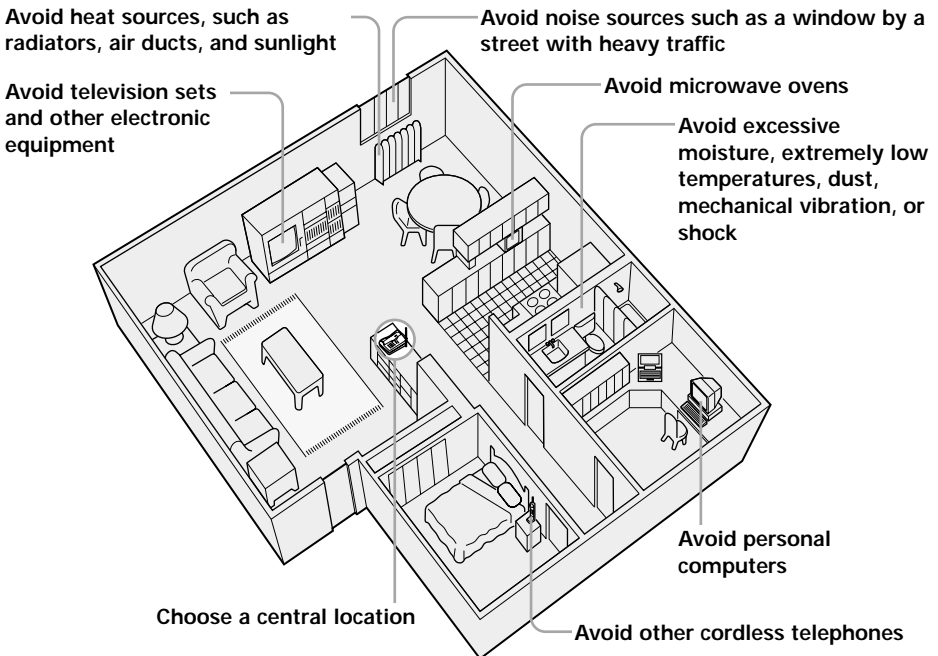

- You should charge your handset for 12-15 hours before using the phone.
- The location should be close to both a phone jack and a continuous power outlet which is not switchable.
- Keep the base and handset away from sources of electrical noise such as motors and fluorescent lighting.
- Be sure there is sufficient space to raise the base antenna fully vertical.
- The base can be placed on a desk, tabletop or mounted on a standard wall plate.

Step 2: Setting up the base unit (continued)

Connect the base unit

To install the base unit on the wall, see page 45.

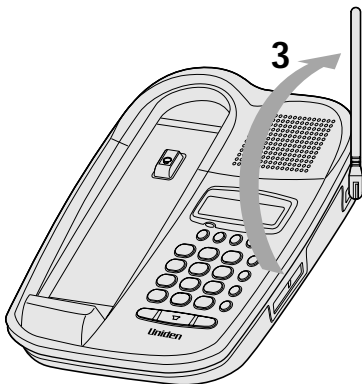
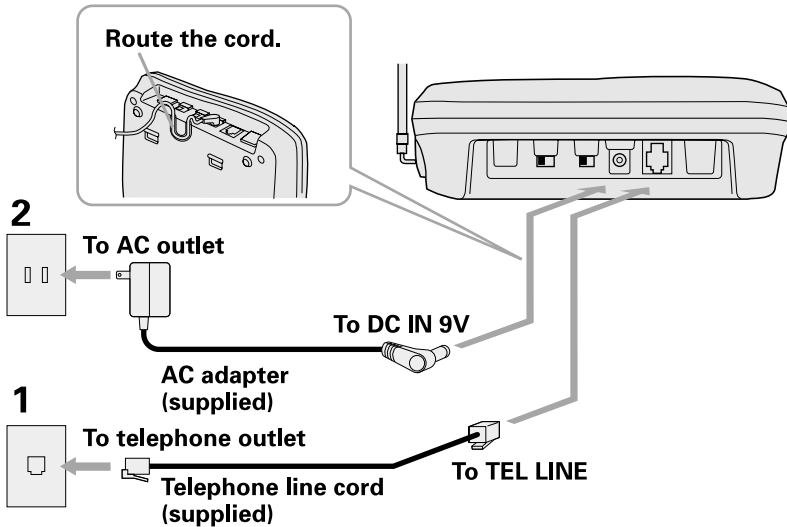

- 1 Connect the telephone line cord to the **TEL LINE** jack and to a telephone outlet.
- 2 Connect the AC adapter to the **DC IN 9V** jack and to a standard 120V AC wall outlet.
- 3 Set the base unit on a desk or tabletop and place the handset on the base unit. Then raise the antenna to a vertical position.

Note

Place the power cord so it does not create a trip hazard, or where it could become chafed and create a fire or electrical hazard.

Step 2: Setting up the base unit (continued)

Notes

- Use only the supplied AD-420 AC adapter. Do not use any other AC adapter.
- Connect the AC adapter to a continuous power supply.

Polarity of the plug

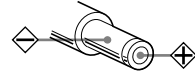

Tips

- If your telephone outlet isn't modular, contact your telephone company for assistance.

Modular



Choose the dialing mode

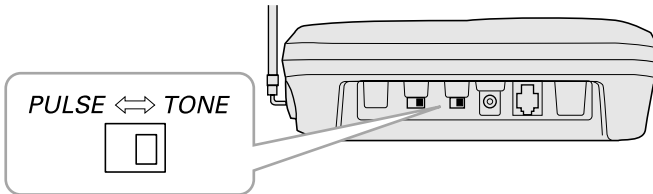

Depending on your dialing system, set the TONE/PULSE switch as follows:

If your dialing system is	Set the switch to
Tone	TONE
Pulse	PULSE

If you aren't sure of your dialing system

Make a trial call with the TONE/PULSE switch set to TONE.

If the call connects, leave the switch as is; otherwise, set to PULSE.

Step 3: Preparing the battery pack

Charge the battery pack for 12-15 hours before you start using your phone.

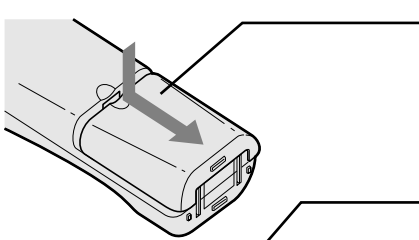

- 1 Press and slide the battery compartment cover toward the bottom of the unit.

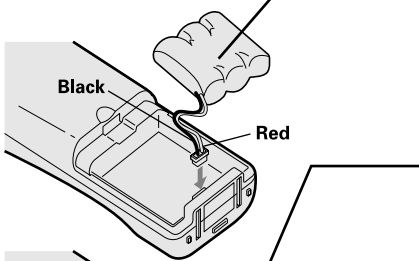

- 2 Connect the battery pack connector with the correct polarity (black and red wires), then insert the battery pack into the battery compartment.

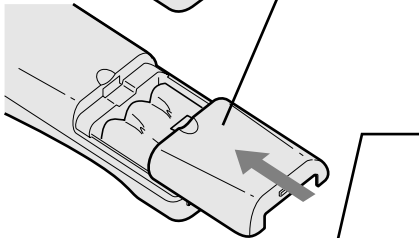

- 3 Securely close the battery compartment cover by sliding it up until it snaps into place.

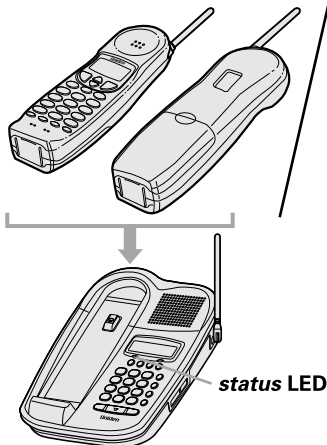

- 4 Place the handset on the base unit with the keys and display facing upward. This position lets you see Caller ID messages on the display.

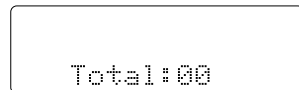

When the handset has been properly placed on the charging terminals of the base unit, the "**status**" LED of the base unit lights and charging begins. Charge the battery for 12-15 hours. You can place either side up for charging the battery.

Step 3: Preparing the battery pack (continued)

Battery use time (per charge)

From fully charged

- 7 hours continuous use
- 10 days when the handset is in the standby mode

When the battery charge becomes low

When the battery pack is very low and needs to be charged, the phone is programmed to eliminate functions in order to save power. If the phone is not in use, "Low Battery" flashes and none of the keys will operate. If the phone is in use, "Low Battery" flashes and the handset beeps. Complete your conversation as quickly as possible and return the handset to the base unit for charging.



Low Battery

Notes

- Even when the battery pack is not being used, it will gradually discharge over a long period. For optimum performance, be sure to return the handset to the base unit after a telephone call for battery charging.
- The built-in memory backup can hold numbers and names stored in the memory for up to 2 minutes, while you replace the battery pack.
- If you must replace the battery pack during a telephone call, complete the replacement of the battery pack within 30 seconds, and you can return to the original call.

Cleaning the battery contacts

To maintain a good charge, it is important to clean all battery contacts on the handset and base unit about once a month. Use a dry cloth or pencil eraser, if necessary.

Do not use any liquids or solvents.

Step 4: Entering your area code

If you enter a 3-digit area code number in the Area Code option, your local area code does not appear in Caller ID messages. When reviewing Caller ID messages, you will see only the local seven digit number. For calls received from outside your local area code, you will see a full 10-digit number.

Note

If your calling area requires 10-digit dialing, do not program this option.

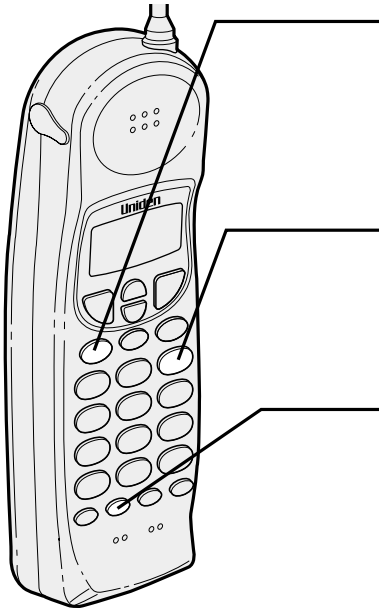

- 1 When the phone is in the standby mode, press **(options)** .
The Caller ID setting screen appears.

```
1 Auto Talk:Off
2 CIDCW      :On
3 Area Code:
```

- 2 Press **(3)** to select
"Area Code".

```
1 Auto Talk:Off
2 CIDCW      :On
3 Area Code:
```

- 3 Press **(select/ch)** .

```
1 Auto Talk:Off
2 CIDCW      :On
3 Area Code:█
```

- 4 Use the number keypad (**(0)** to **(9)**)
to enter the 3-digit area code.

- 5 Press **(select/ch)** .
A beep sounds and the displayed area code is entered.

- 6 Press **(options)** to complete the setting. Or return the handset to the base unit to complete the setting mode and set the handset to the standby mode.

Note

When the area code has already been stored in memory, the stored area code will be displayed. To change it, use the **(del/int'com)** and number keypad to enter the new area code. Then press **(select/ch)** .

```
1 Auto Talk:Off
2 CIDCW      :On
3 Area Code:817
```

To complete the setting, press **(options)** or return the handset to the base unit.

Making calls

Making a call with the handset

Dialing from standby

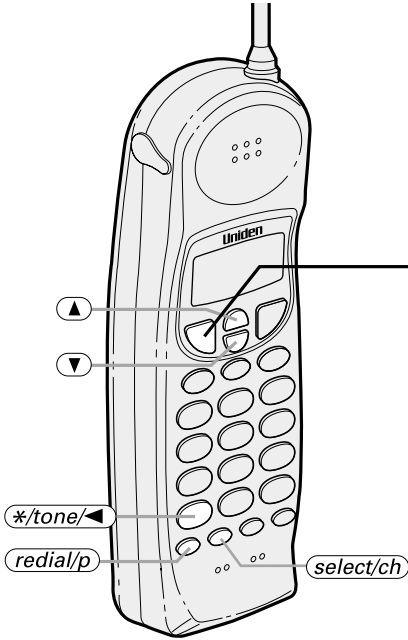

- 1** Pick up the handset and dial the phone number (up to 32 digits).

Example: Enter 8178583300

8178583300

- 2** Press **(talk)**. "Talk" flashes on the display.

<Talk>
8178583300

Then the volume setting is displayed.

Example:
Setting "High"

Talk
<High>

- 3** The number is dialed. After about 5 seconds, the call-time display appears.

Talk 0:00
8178583300

- 4** To hang up, press **(talk)** or place the handset on the base. The call-time displays for about 5 seconds.

5:15

Other Operations

To	Do this
To improve reception	Press (select/ch) during a call.
To adjust the earpiece volume	Press (▲) or (▼) .
To temporarily switch to tone dial (When base is set to pulse mode.)	Press (*/tone/◀) . The following numbers dialed will be sent as tone dialing.
To enter a pause within the dialing sequence	Press (redial/p) .

Notes

- If you enter a wrong number in the step 1, press **(del/int'com)** to delete a number.
- If there is no key entry for more than 20 seconds, the dialing operation is canceled and the telephone returns to the standby mode.
- "Handset in Use" appears on the base's display while the handset is in use.

Making calls (continued)

Dialing from talk mode

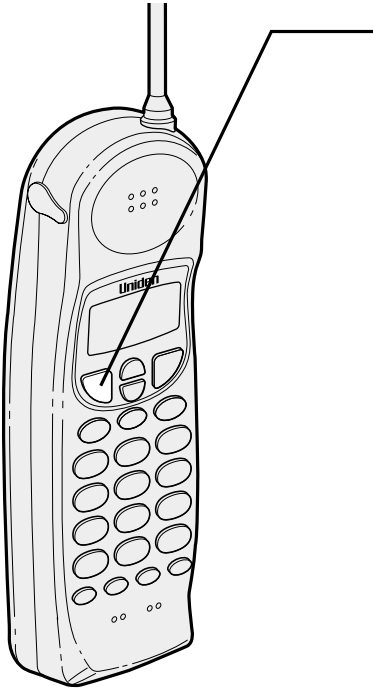

- 1 Pick up the handset.
- 2 Press **(talk)**. "Talk" appears flashing on the display.



The display shows the current selected volume.



- 3 Dial the phone number.

Example: Enter 817-858-3300



- 4 To hang up, press **(talk)** or place the handset on the base. The call-time will be displayed for about 5 seconds.

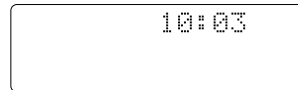

Making a call with the base

Dialing from standby

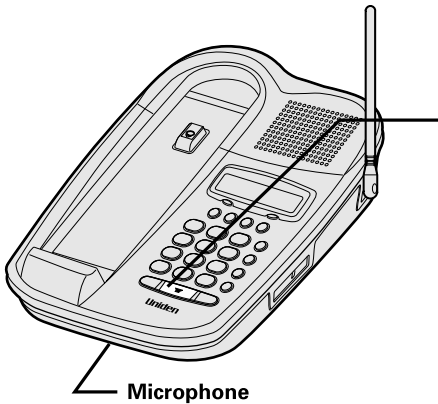

- 1 Dial the phone number (up to 32 digits).
- 2 Press **speaker** . "Speaker" appears on the display. The number is dialed.
- 3 To hang up, press **speaker** .

Dialing from speaker phone mode

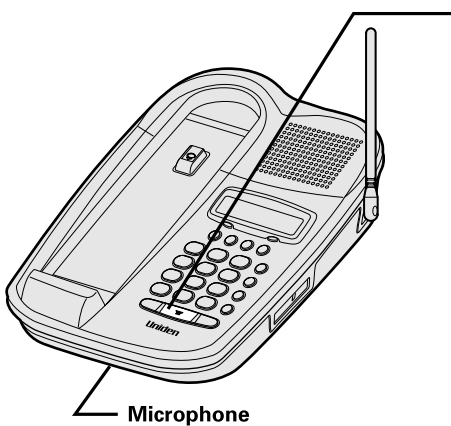

- 1 Press **speaker** . "Speaker" appears on the display.
- 2 Dial the number.
- 3 When you finish the call, press **speaker** to hang up.

Note

The base microphone is located under the phone. Position yourself as near to the base as possible and speak clearly.

Redialing a call with the handset

The last three phone numbers dialed can be quickly recalled.

Dialing from standby

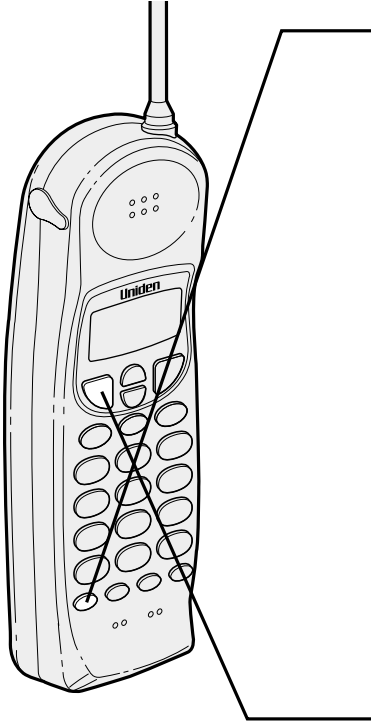

- 1** Press **(redial/p)**.
The phone number that was last dialed from the handset appears on the display.
- 2** Press **(redial/p)** again.
Each press of **(redial/p)** will display one of the last three dialed numbers.

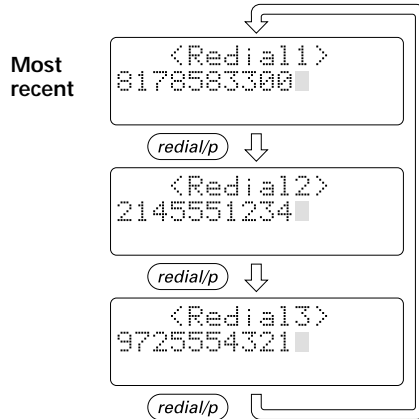

- 3** Press **(talk)**.
The number will be dialed.

Note

If the recently dialed number exceeds 32 digits, only the first 32 digits are retained for redialing.

Making calls (continued)

Dialing from talk mode

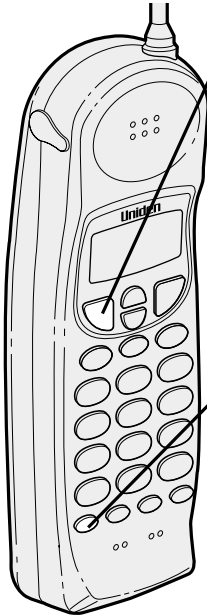

- 1 Press **talk** .
"Talk" appears flashing on the display.



- 2 Press **redial/p** .
The last number dialed will be displayed and redialed.

- 3 To hang up, press **talk** or place the handset on the base.

Redialing a call with the base

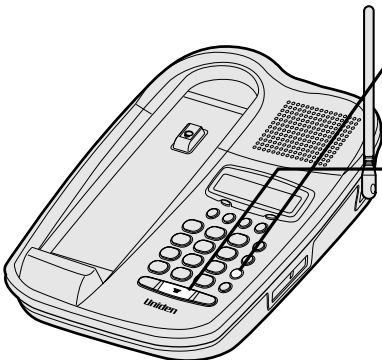

- 1 Press **redial** . The last number dialed from the base will be displayed (up to 32 digits).

- 2 Press **speaker** .
The number will be dialed.

Tips

You can also press **speaker** before pressing **redial** when you redial with the base.

Receiving a call with the handset

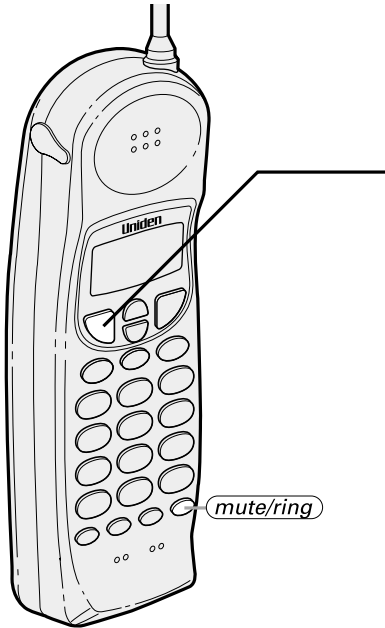

- 1** The phone rings.

Incoming Call

- 2** Press **(talk)**. "Talk" appears flashing on the display.

Talk

Then the currently selected earpiece volume is displayed for 2 seconds.

For example, if the volume is set to high, the display shows:

Talk 0:00
<High>

- 3** The call-time display starts. Talk with the caller.

Talk 0:02

- 4** To hang up, press **(talk)** or place the handset on the base.

The call time displays for about 5 seconds.

115:35

Auto Talk when ringing

When the Auto Talk setting is on and there is an incoming call, simply lift the handset from the base unit to answer the phone. (See page 35.)

Any key Talk when ringing

When the handset is off of the base, pressing any handset key (except **(mute/ring)**) lets you answer the phone. (See page 35.)

Mute when ringing

You can temporarily mute the handset's ringer by pressing **(mute/ring)** when the phone rings. Press **(talk)** to answer the call.

Receiving calls (continued)

Handset ringer tone

In the standby mode, press **(mute/ring)**.

Each time **(mute/ring)** is pressed, the ringer tone setting changes and the selected ringer tone sounds for 2 seconds.

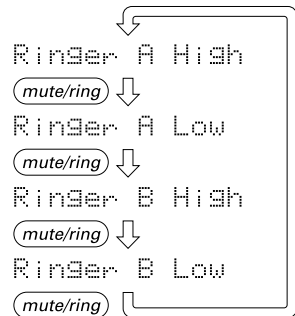

Handset ringer switch

This switch turns the handset ringer on or off.

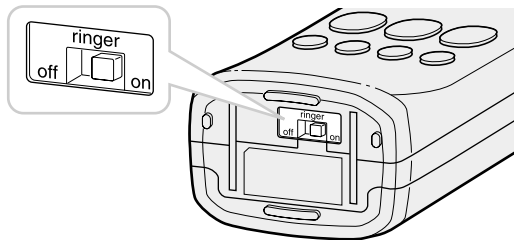

Handset earpiece volume

Pressing **(▲)** or **(▼)** during a telephone call or while the handset is in standby mode, will change the earpiece volume of the handset. This setting will remain in effect after the telephone call has ended.

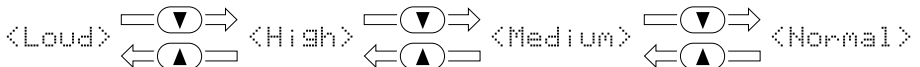

When you press **(▲)** in Loud mode or press **(▼)** in Normal mode, an error tone sounds.

Traveling out of range

During a call, as you begin to move your handset too far from your base unit, noise increases. If you pass the range limit of the base unit, your call will terminate within 30 seconds.

Receiving a call with the base

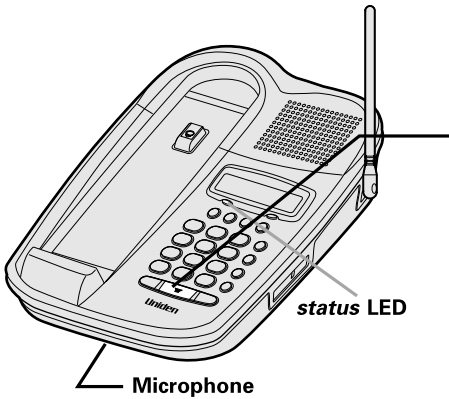

- 1 The base rings. The **status** LED on the base flashes and "Incoming Call" appears on the display.
- 2 Press **speaker**.
- 3 When you finish the call, press **speaker** to hang up.

Base ringer switch

This switch turns the base ringer on or off.

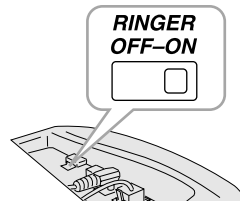

Base speaker volume

To control the speaker volume of the base, adjust the **VOLUME** slide switch as desired.

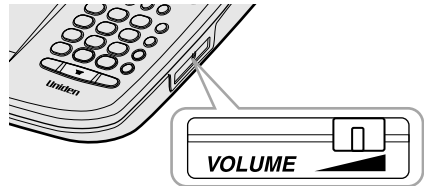

Memory storing

Your EXI 8966 stores up to 20 names and numbers in the handset plus 14 numbers in the base.

Storing phone numbers and names

With the handset

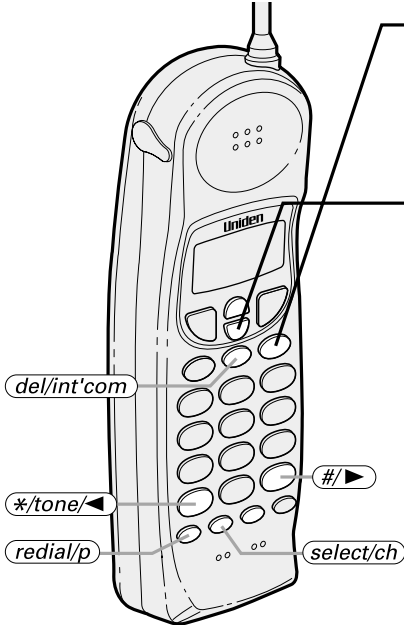

- 1 Press and hold **mem** until "Memory Store" is displayed.

```
Memory Store
01 UNIDEN CORP
02 JOHN DOE
```

- 2 Press **▲**, **▼**, or enter a two-digit number (01 - 20) to select the memory location where you would like to store the number.

```
Memory Store
02 JOHN DOE
03▶
```

- 3 Press **select/ch**.
The following screen appears and a cursor flashes indicating that the display is ready for the name to be entered.

```
Store Name
█
```

If this screen appears, the selected memory location is already stored. Then you must either change the entry in this location, clear the location, or select "Go Back" to choose another location.

```
▶ Edit Memory03
Delete Memory03
Go Back
```

Memory storing (continued)

4 Use **▲** , **▼** , **#/▶** , ***/tone/◀** , or **(del/int'com)** to enter the name. The name cannot exceed 13 characters.

- Use **▲** and **▼** to scroll through the character menu. It contains upper and lower case letters and various characters.
- Use **#/▶** and ***/tone/◀** to move the cursor to the desired location.
- Use **(del/int'com)** key to delete characters as needed.

5 Press **(select/ch)** .
"Store Number" is displayed. The cursor flashes indicating that the display is ready for the number to be entered.

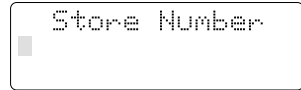

Store Number

6 Use the number keypad to enter the phone number.
The phone number cannot exceed 20 digits.
• Use **(redial/p)** to enter pause in the dialing sequence. The display shows a "F".



Store Number
817858330

Note The pause feature is useful for long distance calling, credit card dialing, or sequences that require a pause between digits.

- Use **(del/int'com)** to delete digits as needed.

7 Press **(select/ch)** .
The handset beeps and displays the confirmation screen. Memory storage is complete.

For example, if you store a name and number into memory location number 03, the display shows "Memory03 Stored".

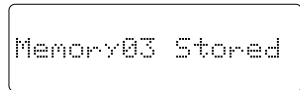

Memory03 Stored

After about 2 seconds, "Memory Store" is displayed.

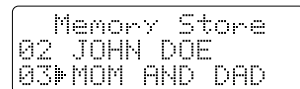

Memory Store
02 JOHN DOE
03▶ MOM AND DAD

8 Press **(mem)** to return to standby mode.

Note

When you are using a menu screen, you must press a key within 20 seconds or the phone will return to standby. If you return the handset to the base, the phone will return to standby.

Memory storing (continued)

With the base

Note You can store only numbers in the base memory.

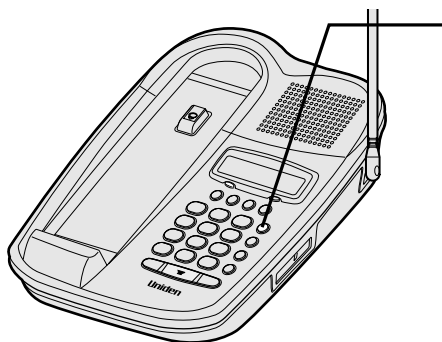

- 1** Press and hold **memory** until "Store Number" is displayed.
- 2** Dial the number (up to 20 digits).
- 3** Press **memory**. "Select Location" is displayed.
- 4** Press the number keypad (0-9) or one touch dial key (**m1** - **m4**). A tone sounds and the number is stored.

Memory dialing

With the handset Dialing from standby

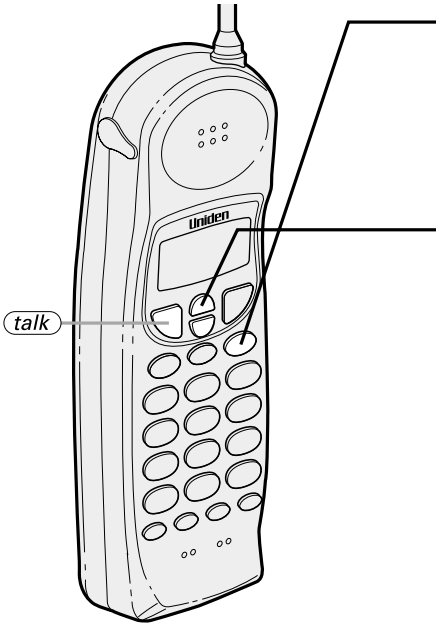

1 Press **(mem)**.
The handset displays your programmed memory locations.

```
01 UNIDEN CORP
02 JOHN DOE
03▶MOM AND DAD
```

2 Press **(▲)**, **(▼)**, or enter a two-digit number (01 - 20) to select the memory location you would like to dial.

3 Press **(talk)**. "Talk" flashes and the volume setting appears on the display. Then the displayed number is dialed.

```
-Talk-
0123456789012
```

Notes

- If you press **(select/ch)** before **(talk)**, you can confirm the name and number stored in the selected memory location.
- To exit the memory function without dialing, press **(mem)**. The handset returns to standby.
- Whenever you are using a menu screen, you must press a key within 20 seconds or the phone will return to standby.

Display a Programmed Number

Use **(#/▶)** and **(*/tone/◀)** to toggle between the names display and the numbers display.

Program name

```
01 UNIDEN CORP
02 JOHN DOE
03▶MOM AND DAD
```

Program number

```
01 8178583300
02 5452930
03▶8175551212
```

Note

When the stored phone number has 14 or more digits, "➔" is displayed next to the 12th digit. Press **(#/▶)** to see the extra digits and **(*/tone/◀)** to return.

```
15 0123456789012
16▶011813554329+
17
```

Memory dialing (continued)

Dialing from talk mode

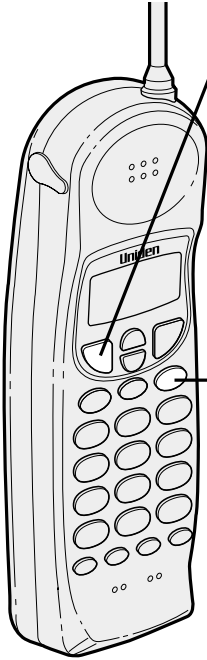

- 1 Press **talk** .
"Talk" flashes and the volume setting appears.

```
Talk
```



```
Talk  
<High>
```

- 2 Press **mem** .

```
Talk 0:00
```

- 3 Enter a two-digit number (01 - 20) to select the memory location of the desired phone number.

The selected phone number is displayed, then the number is dialed.

```
Talk 0:35  
0123456789012
```

Memory dialing (continued)

With the base

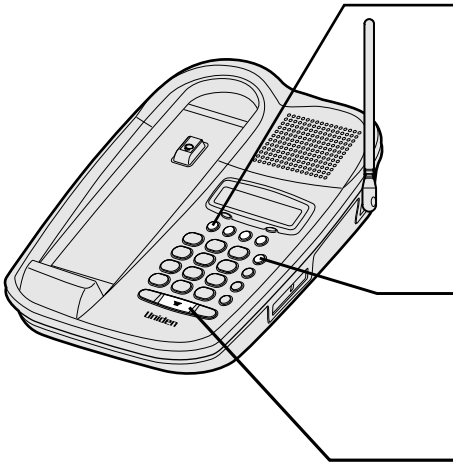

One touch dialing

- 1 Press the one touch dial key (**m1** - **m4**) to dial the numbers stored in location **m1** - **m4** .
- 2 Press **speaker** to hang up.

Standard dialing

- 1 Press **memory** . "Select Location" is displayed.
- 2 Enter the memory location (0-9 or m1-m4), then the number is displayed.
- 3 Press **speaker** .

Note

To use the one - touch dial keys, store numbers directly into the one - touch dial keys (**m1** - **m4**).

Memory editing

Editing a stored name and/or phone number

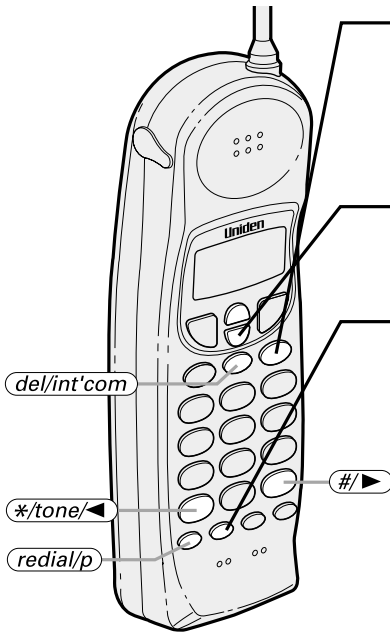

- 1** Press and hold **(mem)** until "Memory Store" is displayed.

```
Memory Store
01 UNIDEN CORP
02 JOHN DOE
```

- 2** Press **(▲)**, **(▼)**, or enter a two-digit number (01 - 20) to select the memory location you would like to edit.

- 3** Press **(select/ch)**.
The following screen appears with the memory location number that you have selected in the display.

```
▶ Edit Memory01
Delete Memory01
Go Back
```

- 4** Press **(▲)** or **(▼)** to select "Edit Memory", then press **(select/ch)**.

The following screen appears.

The cursor flashes indicating that the display is ready for the name to be edited. When a name has not been stored, the cursor appears at the beginning of the second line.

```
Store Name
UNIDEN CORP█
```

- 5** Press **(▲)**, **(▼)**, **(#/▶)**, **(*/tone/◀)**, or **(del/int'com)** to enter the name. (See page 21.)
To edit only the phone number, skip this step.

- 6** Press **(select/ch)**.
The following screen appears. The cursor flashes indicating that the display is ready for the number to be edited.

```
Store Number
017856330█
```

Memory editing (continued)

7 Use the number keypad, **(redial/p)**, or **(del/int'com)** to enter the phone number. The phone number cannot exceed 20 digits. (See page 21.) When the phone number will not be edited, skip this step.

8 Press **(select/ch)**. The handset beeps and displays the confirmation screen. The memory storage is complete.



Memory01 Stored

For example, if you store a name and number into memory location number 01, the display shows "Memory01 stored".

After about 2 seconds, "Memory Store" is displayed.



Memory Store
01 UNIDEN CORP
02 JOHN DOE

9 Press **(mem)** to return to standby mode.

Note

To edit stored numbers in the base, simply overwrite the previous numbers. (See "Memory Storing with the base" section on page 22.)

Memory erasing

Erasing a stored name and phone number

With the handset

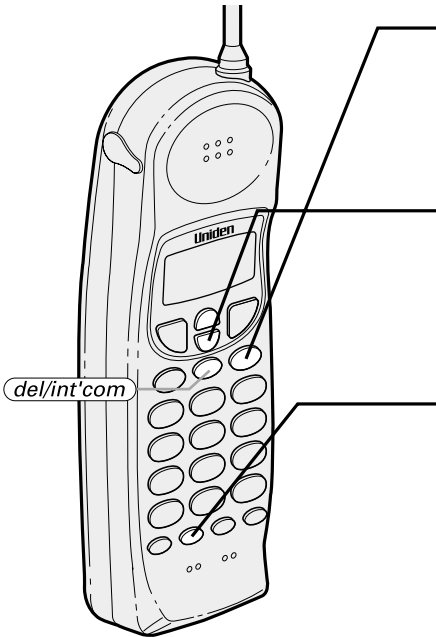

- 1** Press and hold **(mem)** until "Memory Store" is displayed.

```
Memory Store
01 UNIDEN CORP
02 JOHN DOE
```

- 2** Press **(▲)**, **(▼)**, or enter a two-digit number (01 - 20) to select the memory location you would like to edit.

```
Memory Store
01 UNIDEN CORP
02 JOHN DOE
```

- 3** Press **(select/ch)**. The following screen appears with the memory location number that you have selected in the display.

```
▶ Edit Memory02
Delete Memory02
Go Back
```

- 4** Press **(▼)** to move the pointer down to "Delete Memory" command line.

```
Edit Memory02
▶ Delete Memory02
Go Back
```

- 5** Press **(select/ch)**. The following confirmation screen appears.

```
Delete Memory02?
Yes
▶ No
```

- 6** Press **(▲)** to move the pointer to "Yes".

- 7** Press **(select/ch)** or **(del/int'com)**. There is a confirmation tone and the entry is deleted. The following screen appears.

```
Memory02 Deleted
```

- 8** After a few seconds, the display returns to the "Memory Store" screen. You may select another number to delete (return to step 2) or press **(mem)** to return to standby.

Memory erasing (continued)

With the base

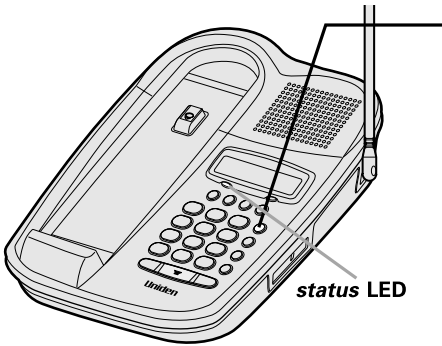

- 1** Press and hold **memory** until "Store Number" is displayed.
- 2** Press **memory** again.
- 3** Enter the memory location number (0 - 9 or m1 - m4) you wish to delete.

A tone sounds and the display shows the confirmation screen.

Mute

You can turn off the base or the handset microphone so that the person you are talking with cannot hear you.

When speaking with the base

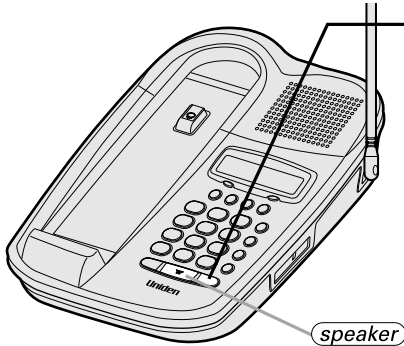

- 1 Press **mute** during a telephone call. "Mute" is displayed and the microphone is turned off.
- 2 To cancel mute, press **mute** or **speaker**.

When speaking with the handset

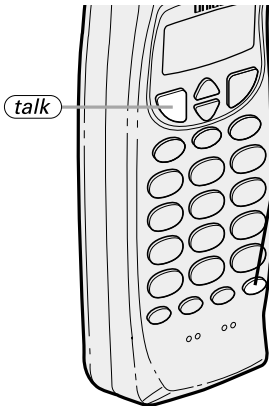

- 1 Press **mute/ring** during a telephone call.

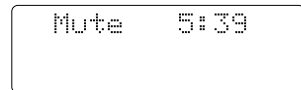

The microphone is turned off.

- 2 To cancel mute, press **mute/ring** or **talk**.

When the phone is ringing

You can temporarily mute the handset's ringer by pressing **mute/ring** when the phone rings. Press **talk** to answer the call.

3-way conference features

The Uniden EXI 8966 permits 3-way conversations between the handset, base and an outside line.

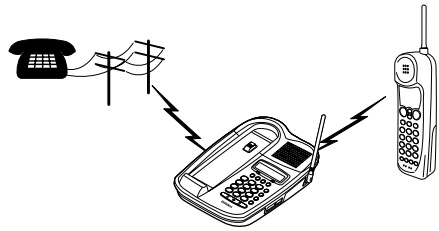

When speaking on the handset



- 1 Press **speaker** on the base to join the 3-way conversation.
- 2 To hang up, press **speaker** on the base. The handset remains connected to the call.

When speaking on the base

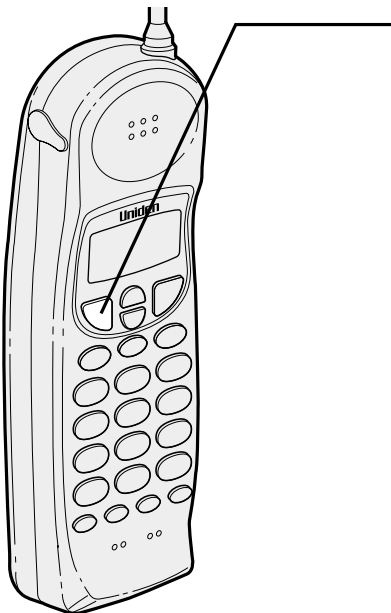

- 1 Press **talk** on the handset to join the 3-way conversation.
- 2 To hang up, return the handset to the base or press **talk** on the handset. The base remains connected to the call.

Notes

- Pressing **speaker** on the base while dialing with the handset will set the 3-way conversation mode, and dialing is not affected.
- During a 3-way conversation, you can dial only from the handset.

Intercom feature

Intercom from the base to handset

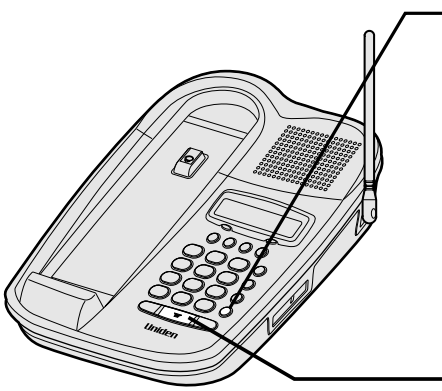

- 1 Press **page/int'com** on the base. The handset beeps. (If no answer, press **page/int'com** again to disconnect.)

Paging Handset

- 2 Press **del/int'com** or **talk** on the handset to answer. "Intercom" appears on the display.
- 3 To turn off the intercom, press **talk** on the handset or **speaker** on the base.

Intercom from the handset to base

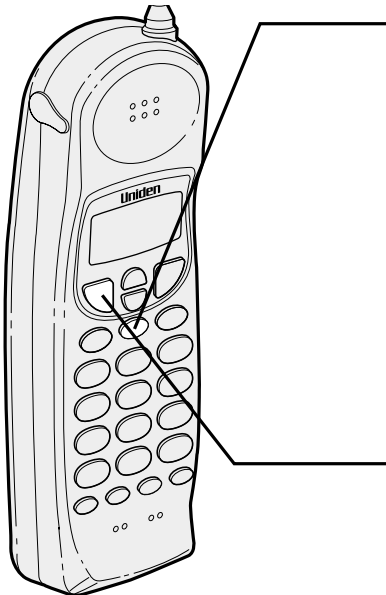

- 1 Press **del/int'com** on the handset. (If no answer, press **del/int'com** again to disconnect.) The following screen appears. The intercom tone sounds on the base.

Paging Base

- 2 At the base, press **page/int'com** or **speaker** to answer. "Intercom" appears on the display. Speak into the base microphone.
- 3 To turn off the intercom, press **talk** on the handset or **speaker** on the base.

Note

- If the page is not answered within one minute, the paging sound stops automatically.

Call transfer feature

To transfer from the handset to the base

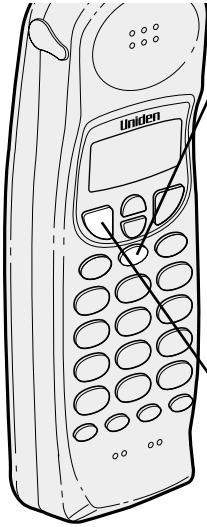

- 1 Press **(del/int'com)** on the handset during a telephone call. The caller is put on hold and the intercom tone sounds on the base.

Hold
Pending Base

- 2 Press **(page/int'com)** or **(speaker)** on the base. The intercom mode is activated, but the caller is still on hold.
- 3 To transfer the call to the base, press **(talk)** on the handset.

To cancel the transfer, press **(speaker)** on the base.

To transfer from the base to the handset

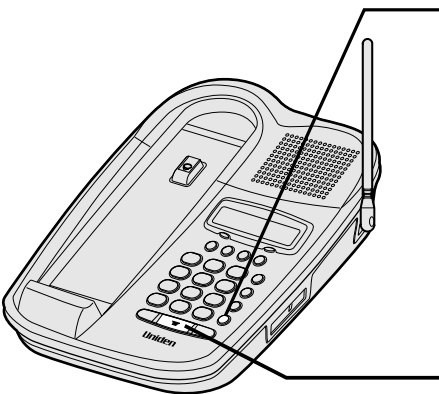

- 1 Press **(page/int'com)** on the base during a telephone call. The caller is put on hold and the intercom tone sounds on the handset.

Hold
Pending Handset

- 2 Press **(del/int'com)** or **(talk)** on the handset. The intercom mode is activated, but the caller is still on hold.
- 3 To transfer the call to the handset, press **(speaker)** on the base. To cancel the transfer, press **(talk)** on the handset.

Caller ID service

You must subscribe to the Caller ID service from your telephone company to use this feature.

When the telephone rings, the Caller ID feature allows you to view the caller's name and phone number on the handset and base display before you answer the phone.

The handset displays the phone number of the incoming call, the name, time, and the number of calls. Additionally, you can dial the displayed number and store the information for memory dialing.

The base displays only the name and the phone number of the incoming call. After the call has ended, the information is retained in the handset's Caller ID memory. Additional Caller ID features can only be accessed on the handset.

Setting the Caller ID options

There are three Caller ID setup options available. They are AutoTalk, CIDCW (Caller ID on Call Waiting), and Area Code (page 11).

Auto Talk allows you to answer the phone without pressing **(talk)**. If the phone rings when AutoTalk is on, simply remove the handset from the base and the phone automatically answers the call. Or, if the handset is not on the base, press any key (except **(mute/ring)**) to answer the call. If the phone rings when AutoTalk is off, you must press **(talk)** to answer the call.

Caller ID on Call Waiting (CIDCW) performs the same as regular Caller ID on a call waiting number. Call Waiting options allow you to handle call waiting calls in seven different ways.

You must subscribe to CIDCW and CIDCW options from your phone company in order to use this feature.

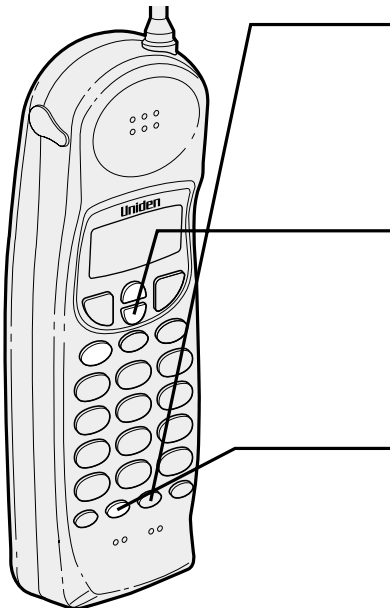

- 1 In the standby mode, press **(options)**. The Caller ID setting menu appears.

```
1 Auto Talk: Off
2 CIDCW      : On
3 Area Code:
```

- 2 Press **(▲)** or **(▼)** to move the pointer to the item that is to be set.

Example: To select CIDCW

```
1 Auto Talk: Off
2 CIDCW      : On
3 Area Code:
```

- 3 Press **(select/ch)** to toggle between On and off for Auto Talk. For CIDCW, choose On, Off or Off depending on the type of service to which you subscribe.
- 4 To complete the settings, press **(options)** and return the handset to the base. The phone returns to standby mode.

When the telephone rings

- 1** When the Caller ID message is received, the handset display shows the caller's phone number along with the date and time. The incoming call information is stored in the Caller ID record.
If the Caller ID service includes the caller's name, the caller's name appears on the display (up to 15 letters).

Number of calls from the same phone number _____
The date and time received _____ 5/11 12:30PM 01
Caller's name _____ UNIDEN CORP
Caller's phone number _____ 813-858-3300

Here are some typical displays;

When the phone number and name data are received

```
5/11 12:30PM 01
UNIDEN CORP
817-858-3300
```

When a private name is received

```
5/11 12:30PM 01
Private Name
817-858-3300
```

When an unknown name is received

```
5/11 12:30PM 01
Unknown Name
817-858-3300
```

When invalid data is received

```
Incomplete Data
```

When a private number is received

```
5/11 12:30PM 01
UNIDEN CORP
Private Number
```

When an unknown number is received

```
5/11 12:30PM 01
UNIDEN CORP
Unknown Number
```

- 2** When the telephone is answered, the display changes to "Talk".

Notes

- If you answer a call before the Caller ID message is received (Example: before the second ring), the Caller ID message will not appear.
- When the call is received via a telephone company that does not offer Caller ID service, the caller's phone number and name do not appear. (This includes international calls.)
- When the call is via a private branch exchange (PBX), the caller's phone number and name may not appear.
- Data errors appear as "■".
- The base displays only name and number information. All additional information is retained on the handset.

```
5/11 12:30PM 01
UNI■EN CORP
813-8■-3300
```

Viewing the Caller ID message list

The Caller ID list stores information for up to 50 incoming calls—even unanswered calls.

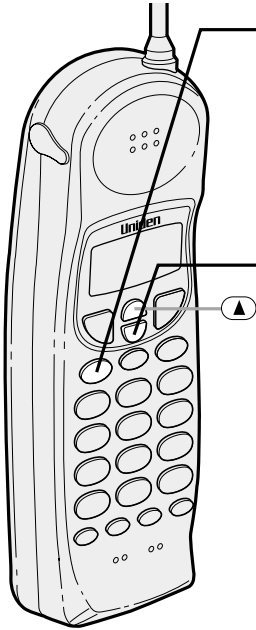

- 1 Press **call id** .
The summary screen appears. The screen shows the number of new messages and total messages.

```
New :01  
Total:02
```

- 2 Press **▼** to display the latest caller ID message.

```
5/17 12:30PM 03  
UNIDEN CORP  
817-858-3300
```

- 3 Press **▼** to see the next message, or press **▲** to see previous message.

- 4 Press **call id** to return to standby.

Long Distance call and area code settings

While the incoming call information is displayed, press **1** to return a long distance call. The prefix "1-" will be displayed at the beginning of the phone number . Press **3** to include the area code. Pressing **1** and **3** repeatedly sets and cancels these settings. (When the phone number is 15 digits long, " _ " is not displayed.)

```
5/17 12:30PM 03  
UNIDEN CORP  
1-817-858-3300
```

Notes

- "End" appears when you have received all messages in the Caller ID list. Press **▲** repeatedly to return to the summary screen.
- Each message can be up to 15 characters for the phone number and the name.
- If a call comes in via a telephone system that does not offer Caller ID service, no information is stored.

Deleting information from the Caller ID list

The EXI 8966 stores up to 50 messages. If the phone receives the 51st message, the oldest one in the list is automatically deleted.

Caller ID data can also be deleted manually.

Deleting a Caller ID message

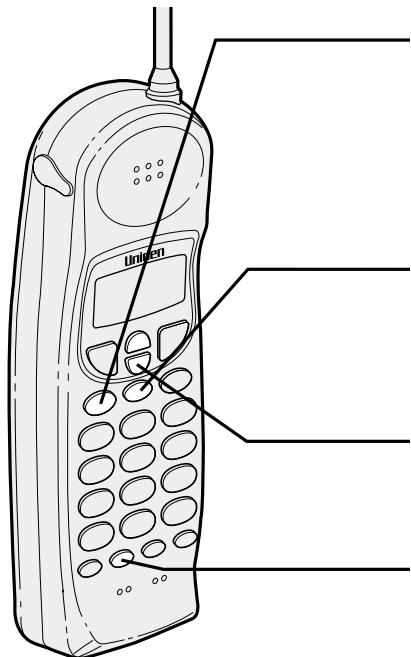

- 1 Press **call id** .
Display the message to be deleted from the Caller ID list by pressing **▲** or **▼** .

```
5/17 12:30PM 03  
UNIDEN CORP  
817-858-3300
```

- 2 Press **del/int'com** . The following screen appears.

```
Delete Message?  
#Yes  
No
```

- 3 Press **▲** or **▼** to select "Yes" or "No".

- 4 Press **select/ch** or **del/int'com** .

When the pointer is at "Yes":

A tone sounds and the Caller ID message is deleted. The next Caller ID message is then displayed.

When the pointer is at "No":

The display returns to the Caller ID display.

Note

- If you get an incoming call, the deleting operation is canceled and the telephone returns to standby.

Deleting information from the Caller ID list (cont'd)

Deleting all Caller ID names and numbers

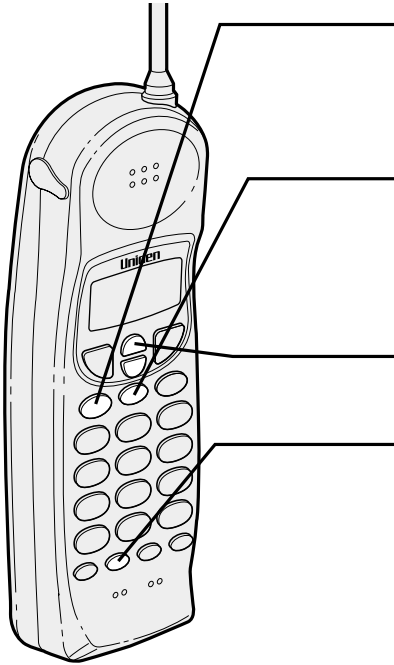

1 Press **(call id)** .

```
New :01
Total:02
```

2 Press **(del/int'com)** . The following screen appears.

```
Delete All?
Yes
▶No
```

3 Press **(▲)** or **(▼)** to select "Yes" or "No" .

4 Press **(select/ch)** or **(del/int'com)** .

When the pointer is at "Yes" :
A tone sounds and all stored Caller ID messages are deleted.

```
Total:00
```

When the pointer is at "No" :
The display returns to the summary screen.

```
New :01
Total:02
```

Note

- If you get an incoming call, the deleting operation is canceled and the telephone returns to standby.

Calling a party from the Caller ID list

You can place a call from the Caller ID list.
The EX1 8966 stores up to 50 messages.

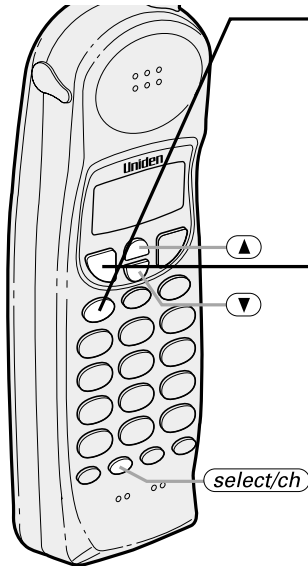

- 1** Press **call id** .
Select the phone number that you want to dial by pressing **▲** or **▼** .

```
5/17 12:30PM 03
UNIDEN CORP
817-858-3300
```

- 2** Press **talk** .

```
>Talk<
8178583300
```

The displayed phone number will be dialed.

Long Distance calls and Area code

Set or cancel a long distance call by pressing **1** and the area code by pressing **3** while the incoming call information is displayed (in step 1).

Dial edit

You can edit the phone number of Caller ID data when you press **select/ch** after the step 1.

```
UNIDEN CORP
8178583300█
```

Notes

- When a long distance call has been set, "1" appears in the display.
- You cannot make a call from the Caller ID list if your EX1 8966 is connected to private branch exchange (PBX).

Storing Caller ID messages in memory

The phone number of the party on the Caller ID list can be stored in memory dialing.

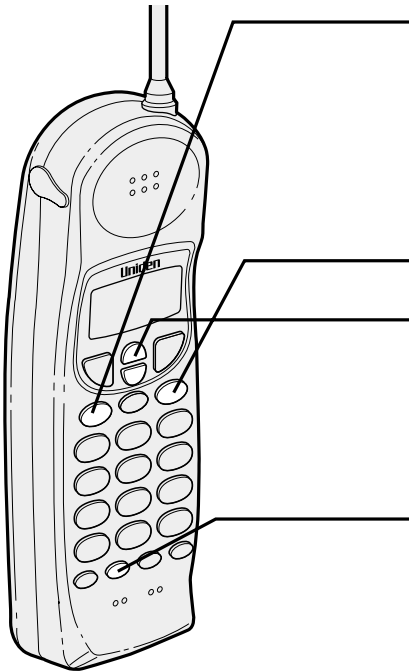

- 1** Press **(call id)** .
Select the phone number to be stored from the Caller ID list by pressing **(▲)** or **(▼)** .

```
5/17 12:30PM 03
UNIDEN CORP
817-858-3300
```

- 2** Press **(mem)** .

- 3** Press **(▲)** , **(▼)** , or enter a two-digit number (01 - 20) to select the memory location.

```
Select Location
01 UNIDEN CORP
02 JONE DOE
```

- 4** Press **(select/ch)** .
A tone will sound. The number is stored in memory, and the display returns to the Caller ID list.

```
5/17 12:30PM 03
UNIDEN CORP
817-858-3300
```

Notes

- If a message has already been stored in the selected memory numbers location, a confirmation screen is displayed.

Press **(▲)** to select "Yes".

Press **(select/ch)** to overwrite. The display returns to the Caller ID list.

- You can not store a Caller ID message if no phone number appears in the message.
- If there is an incoming call or page, memory storage is canceled and the telephone is set to receive the incoming call or page.

```
Replace Memory?
Yes
▶ No
```

Caller ID with call waiting service

"Caller ID" and "Call waiting" are separate services. CIDCW (Caller ID on Call Waiting) performs the same as regular Caller ID on a call waiting number. You must subscribe to the "Caller ID with call waiting (CIDCW)" service from your telephone company before you can use the following features. The "Call waiting" service can also be used independently. Please contact your telephone company for details.



- 1 When a new incoming call arrives during your current telephone call, the phone number and the name of the caller is displayed.

```
Talk 10:30  
UNIDEN CORP  
817-858-3300
```

- 2 Press **(flash)** .
You will be able to talk with the person that has just called. The first caller will be put on hold.
- 3 To return to the first caller, press **(flash)** again.

Notes

- When CIDCW is set to Opt in the caller ID setup menu (see page 35), you can press **(options)** after receiving a call waiting call and view a list of ways to handle the new call. Choose an option using **(▲)** and **(▼)** and press **(select/ch)** to activate.
- When an incoming call is received while you are speaking on the base, press the base, press **(flash)** on the base.

The flash key functions the same on the base as on the handset with the exception of only two lines of display. All the information is retained on the handset's Caller ID memory.

Call waiting features

Your EX1 8966 gives you new options for call waiting. At the touch of a button, you can ask the caller to hold or conference them into your current call. You may be required to subscribe to call waiting and call waiting options to use these features. Not all features are available in all areas. Check with your local telephone company for details.

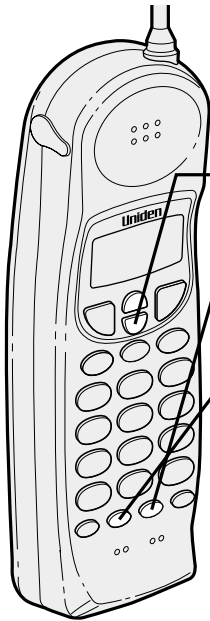

1 When you receive a call waiting call, press **(options)** for a list of options.

2 Press **(▲)** or **(▼)** to select an option.

```
1 Ask to Hold
2 Tell Busy
3 Take Message
```

3 Press **(select/ch)** .
A confirmation screen will appear.

```
Talk 0:15
Call Holding
```

Your EX1 8966 is pre-programmed with seven call waiting options. You may select to ask the calling party to **hold**, send them a **busy** message, or **conference** them into the current call. You may also select to **answer and drop** the first caller or, at any time, choose to **drop the first** or **drop the last** caller.

Check with your local telephone company for a full list of options.

Note

You must set CIDCW to "Off" in the caller ID setting menu (see page 35) to use this feature.

Changing the digital security code

The digital security code is an identification code used to connect the handset and the base unit. Normally, setting the code is not necessary.

The first time you charge your handset, the security code is automatically set. (See page 4.)

In the rare situation that you suspect another cordless telephone is using the same security code, you can change the code.



- 1** Remove the handset from the base unit. Press **(page/int'com)** .
- 2** While the handset is producing the paging sound, hold **(page/int'com)** while placing the handset in the base unit. The paging tone stops. Leave the handset on the base for at least 3 seconds. A random new security code is set.

Note

If the handset battery pack is completely discharged or the battery pack removed, the digital security code will be lost. If this happens, a new security code is set automatically the next time the battery pack is charged.

Mounting the base unit on a wall

Standard wall plate mounting

This phone can be mounted on any standard telephone wall plate.

1

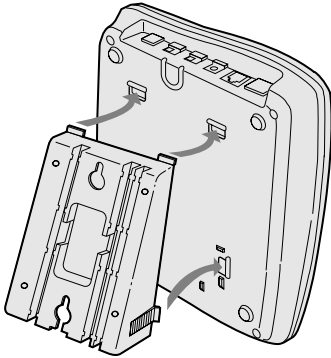

1

Snap the wall mount adapter into the notches on the base.

2, 3, 4,
5, 6, 7

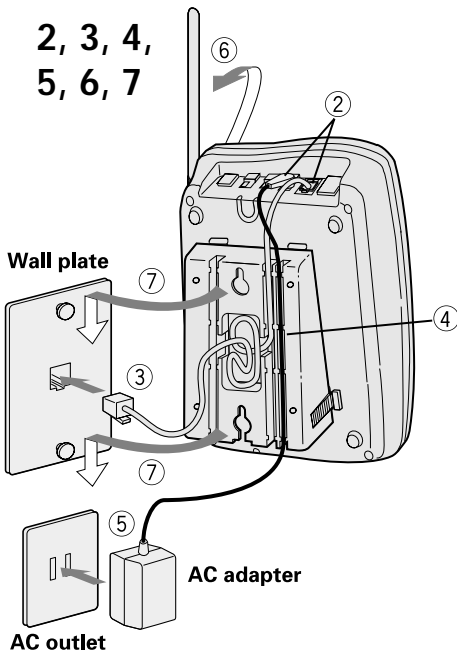

2

Plug the telephone line cord to the **TEL LINE** jack and the AC adapter to the **DC IN 9V** jack.

3

Plug the telephone line cord into the telephone outlet.

4

Place the AC adapter cord inside the molded wiring channel.

5

Plug the AC adapter into a standard 120V AC wall outlet.

6

Raise the antenna to a vertical position.

7

Align the mounting slots on the base with the mounting posts on the wall. Push in and down until the phone is firmly seated.

Note

Use only the Uniden AC adapter supplied with this phone.

Mounting the base unit on a wall (continued)

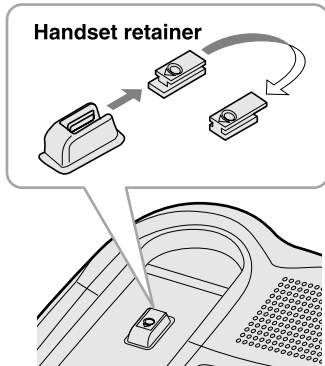

- 8** On the base unit, pull the handset retainer out of the slot.
- 9** Flip the retainer over and slide it back into the slot so that the lip of the retainer is up and the oval is down. The retainer holds the handset in place.

Direct wall plate mounting

If you don't have a standard wall plate, you can mount your phone directly to the wall. Before doing this, consider the following:

- Avoid electrical cables, pipes, or other items behind the mounting location, that could cause a hazard when inserting screws into the wall.
- Try to mount your phone within 10 - 15 feet of a working phone jack to avoid excessive cord lengths.
- Make sure the wall material is capable of supporting the weight of the base and handset.
- Use #10 screws (minimum length of 1- 3/8 inches) with anchoring devices suitable for the wall material where the base unit will be placed.

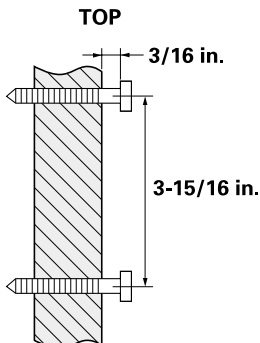

- 1** Insert two mounting screws into the wall, (with their appropriate anchoring device), $3-15/16$ inches apart. Allow about $3/16$ of an inch between the wall and screwheads for mounting the phone.
- 2** Refer to steps 1 through 9 on page 45 and 46 to mount the telephone.

Additional information

Installing the beltclip

To attach the beltclip

Insert the beltclip into the holes on each side of the handset. Press down until it clicks.

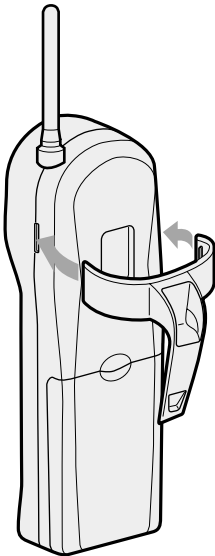

To remove the beltclip

Pull both sides of the beltclip to release the tabs from the holes.

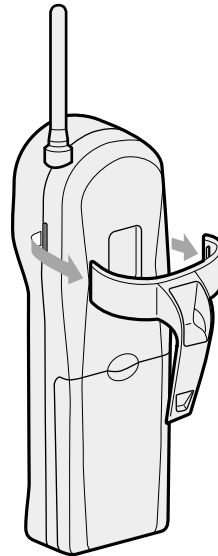

Headset installation

Your phone may be used with an optional headset the Uniden HS910. To use this feature, simply plug the headset plug into the headset jack. Your phone is ready for hands-free conversation.

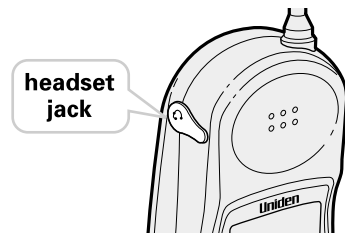

Note on power sources

Battery replacement and handling

When the operating time becomes short, even after a battery is recharged, please replace the battery.

With normal usage, your battery should last about one year.

Please contact your place of purchase for a replacement battery.

Power Failure

During the period that the power is off, you will not be able to make or receive calls with the telephone.

RECYCLING NICKEL-CADMIUM BATTERIES



NICKEL-CADMIUM BATTERIES MUST BE DISPOSED OF PROPERLY.

Nickel-cadmium cells are used in the battery pack. Please take your used nickel-cadmium battery packs to a store that recycles nickel-cadmium batteries.

Caution

- Use the specified battery pack.
- Do not remove the battery from the handset to charge it.
- Never throw the battery into a fire, disassemble it, or heat it.
- Do not remove or damage the battery casing.

Maintenance

When slightly dirty

Wipe with a soft, dry cloth.

When very dirty

Wipe with a soft cloth that has been dampened with diluted, neutral detergent. Dry with a dry cloth.

When the charging terminals become dirty

Wipe with a dry cloth or a pencil eraser, if necessary.

Caution

Do not use paint thinner, benzene, alcohol, or other chemical products. Doing so may discolor the surface of the telephone and damage the finish.

Troubleshooting

If your phone is not performing to your expectations, please try these simple steps first.

Symptom	Suggestion
The status light won't come on when the handset is placed in the base unit.	<ul style="list-style-type: none">• Make sure the AC adapter is plugged into the base unit and wall outlet.• Make sure the handset is properly seated in the base unit.• Make sure the charging contacts on the handset and base unit are clean.
The audio sounds weak and/or scratchy.	<ul style="list-style-type: none">• Make sure that the base unit antenna is in a vertical position.• Move the handset and or base unit to a different location away from metal objects or appliances and try again.• Press (select/ch) during a call to help eliminate background noise.• Make sure that you are not too far from the base.
Can't make or receive calls	<ul style="list-style-type: none">• Check both ends of the base unit telephone line cord.• Make sure the AC adapter is plugged into the base unit and wall outlet.• Disconnect the AC adapter for a few minutes, then reconnect it.• Reset the digital security code (See page 44).• Make sure (talk) is pressed.
The handset doesn't ring or receive a page.	<ul style="list-style-type: none">• The battery pack may be weak. Charge the battery on the base unit for 12-15 hours.• The handset may be too far away from the base unit.• Place the base unit away from appliances or metal objects.• Reset the digital security code (See page 44).
The Caller ID disappears.	<ul style="list-style-type: none">• The handset was picked up before the second ring.
The Caller ID does not display.	<ul style="list-style-type: none">• The call was placed through a switch board.• Call your local telephone company to verify your Caller ID service is current.

At Uniden, we'll take care of you!

If you need any assistance with this product, please call our Customer Hotline at

1-800-297-1023

PLEASE DO NOT RETURN THIS PRODUCT TO THE PLACE OF PURCHASE.

Our Uniden representatives will be happy to help you with any matters regarding the operation of this unit, available accessories, or any other related matters.

Thank you for purchasing a Uniden product.

Hours: M-F 7:00 AM to 7:00 PM CST.

Index

0 - 9

3-way conferencing31

A

Area code11

Auto Talk17, 35

B

Base ringer switch.....19

Base speaker volume19

Battery pack

 Preparing and charging9

 Replacement and handling48

C

Caller ID service

 Calling from the Caller ID list40

 Deleting the Caller ID list38

 Setting the Caller ID options.....35

 Storing the Caller ID data
 to Memory41

 Viewing Caller ID message list37

Caller ID with Call Waiting35, 42

Channel.....12

Connection7

D

Dialing mode.....8

Digital security code4, 44

E, F, G

Earpiece volume18

H

Headset installation47

I, J, K, L

Intercom32

Installing the beltclip.....47

M, N

Maintenance48

Making calls

 Making a call with the base.....14

 Making a call with the handset.....12

Memory dialing23

Memory editing26

Memory erasing28

Memory storing20

Mounting the base unit on a wall45

Mute30

O, P, Q

Package contents5

R

Receiving calls

 Receiving a call with the base19

 Receiving a call
 with the handset17

Redialing15

Handset ringer tone.....18

Handset ringer switch18

S

Setup

 Base unit6

 Handset.....9

T

Transferring a call.....33

Troubleshooting49

U, V, W, X, Y, Z

Using "Caller ID with Call Waiting"
service42

THANK YOU

FOR PURCHASING A UNIDEN PHONE!

Uniden®

Covered under one or more of the following U.S. patents:

4,511,761	4,523,058	4,595,795	4,797,916	5,381,460
5,426,690	5,434,905	5,491,745	5,533,010	5,574,727
5,650,790	5,660,269	5,661,780	5,663,981	5,671,248
5,717,312	5,754,407	5,768,345	5,787,356	5,838,721
5,864,619	5,893,034	5,912,968	5,915,227	5,929,598
5,930,720	5,960,358	5,987,330		

©2000 Uniden America Corporation

All rights reserved • Printed in China UCZZ01706BZ

Free Manuals Download Website

<http://myh66.com>

<http://usermanuals.us>

<http://www.somanuals.com>

<http://www.4manuals.cc>

<http://www.manual-lib.com>

<http://www.404manual.com>

<http://www.luxmanual.com>

<http://aubethermostatmanual.com>

Golf course search by state

<http://golfingnear.com>

Email search by domain

<http://emailbydomain.com>

Auto manuals search

<http://auto.somanuals.com>

TV manuals search

<http://tv.somanuals.com>