

EXP 90 SERIES

OWNER'S MANUAL

Uniden's 900 MHz Cordless

Telephones offer you

outstanding performance and

unparalleled sound clarity.

Uniden[®]

Contents

Introduction	2	• Adjusting Ringer/Volume Controls	7
Features	2	Ringer Tone and Volume	7
Included with Your EXP90 Series Phone	3	Setting the Receiver Volume	7
Controls and Functions	4	EXP93 Charging Cradle	8
Installation	5	Using Your Phone	9
• Selecting a Location	5	• Making and Receiving Calls	9
• Setting the Dial Mode Switch	5	• Storing a Number in Memory	9
• Desk or Tabletop Installation	5	• Storing Mixed Tone/Pulse Numbers	9
• Wall Installation	5	• Dialing a Stored Number	9
Setting the Handset Retainer For Wall Mounting	5	• Chain Dialing	9
Mounting on a Standard Wall Plate	5	• Erasing a Stored Number	10
Mounting Directly on a Wall	6	• Selecting a Different Channel	10
Setting Up Your Phone	7	• Using the Flash Button	10
• Extending the Antenna	7	• Using the Page/Find Feature	10
• Installing the Battery Pack	7	Troubleshooting	11
Charging the handset	7	Specifications	11
Low Battery Indicator	7		
Cleaning the Battery Contacts	7		

Introduction

The EXP90 Series 900 MHz cordless phone is designed and engineered to exacting standards for reliability, long life, and outstanding performance.

▼ Features

- 900 MHz Operation
- EXP93 Charging Cradle
- Any Key Answer
- 10-Number Memory
- Voice Scramble (EXP92 only)
- Wall Mountable
- Battery Saving Feature
- Handset Volume Control
- Redial and Flash
- Extended Range and Clarity
- One-Way Page/Find
- AutoTalk
- AutoStandby
- 40 Channels
- Tone/Pulse Dialing

The EXP90 Series features include *AutoTalk™* and *AutoStandby™*. *AutoTalk™* allows you to answer a call by just

removing the handset from the base so you don't have to waste time pushing buttons or flipping switches. *AutoStandby™* allows you to hang up by simply returning the handset to the base.

The EXP92's *Voice Scramble* protects your privacy by scrambling any call you make or receive. The RF signal between the handset and the base are changed, making it difficult or impossible for someone to receive and understand your phone calls.

The *UltraClear Plus* true compander circuitry virtually eliminates background noise. This innovative technology, together with 40 different channels, provides you with the best possible reception during all your conversations.

To protect you against misbilled calls which might result from your phone being activated by other equipment, the EXP90 Series has *Random Code™* digital security which automatically selects one of over 65,000 digital security codes for the handset and base. Also, the *AutoSecure™* feature electronically locks your phone when the handset is in the base.

To get the most from your phone, please read this owner's manual thoroughly. Also be sure to complete the product registration form and mail it in.

Be sure to visit our web site at: www.uniden.com.

Included with Your EXP90 Series Phone



Base

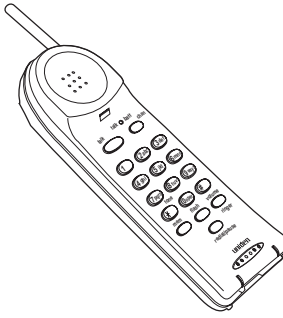

Handset

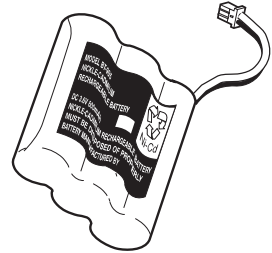

Rechargeable Battery

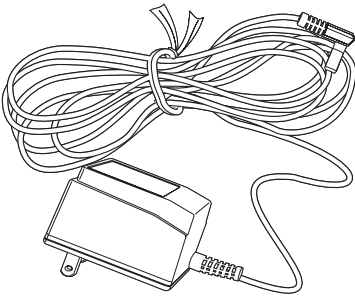

AC Adapter

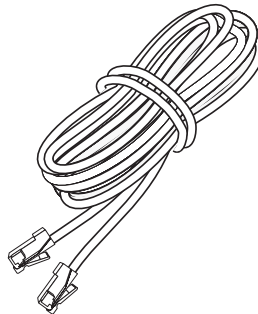

Long Telephone Cord

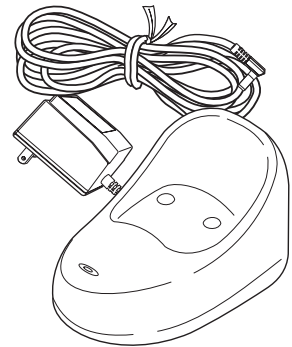

EXP93 Only:
Charging Cradle and Power Supply

Also included:

- This Owner's Manual
- Other Printed Material
- Precautions and Important Safety Instructions

If any of these items are missing or damaged, contact your place of purchase.

Controls and Functions

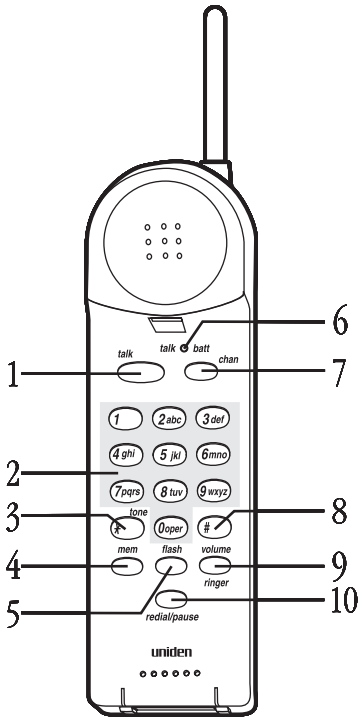

1. **talk** - used to answer calls
2. **keypad** - touchpad keys
3. ***** **tone** - special access key for some phone systems
4. **mem** - used to enter or recall numbers in memory
5. **flash** - used to access call waiting (if available)
6. **talk/batt low** - indicates when phone is in use or the battery is low
7. **chan** - used to select another channel for clearer reception
8. **#** **access key** - special access key for some phone systems
9. **volume/ringer volume** - set both the ringer and earphone volumes
10. **redial/pause** - redials the last number or adds a memory pause
11. **handset retainer** - used to hold handset in base for wall mounting.
12. **power** LED - indicates that AC power is on
13. **in use** LED - indicates the phone is in use
14. **charge** LED - indicates when the handset is charging
15. **page/find** - use to locate the handset

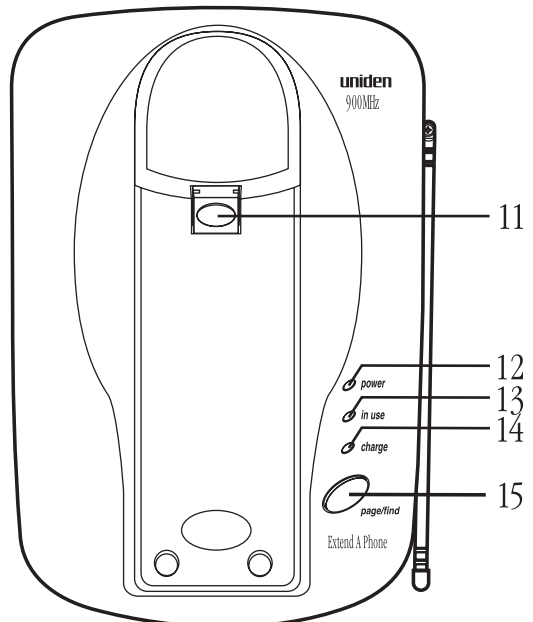

Installation

Selecting a Location

Before choosing a location for your new phone, read the "Installation Considerations" included in the "Precautions and Important Safety Instructions" brochure.



Important: Place the power cord so that it does not create a trip hazard, or where it could become chafed and create a fire or other electrical hazards.

Setting the Dial Mode Switch

Place the switch in the **T** position for tone dialing, or the **P** position for pulse dialing.

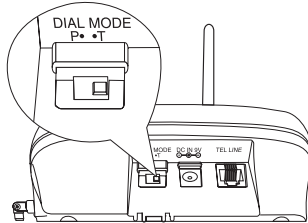

Desk or Tabletop Installation

1. Plug the AC adapter cord into the 9V DC input jack on the base.

2. Wrap the AC adapter cord inside the molded strain-relief.

3. Plug one end of the long telephone cord into the **TEL LINE** jack on the base.

4. Raise the antenna on the base.

5. Plug the other end of the telephone cord into the telephone wall jack.

6. Plug the AC Adapter into a standard 120V AC wall outlet that is not controlled by a wall switch.



Use only the AC adapter that came with the phone.

Wall Installation

▼ Setting the Handset Retainer For Wall Mounting

1. Remove the handset retainer on the base by sliding it upward.

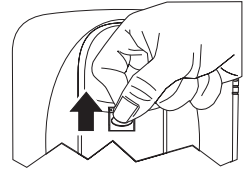

2. Flip the retainer over so the tab is facing up.

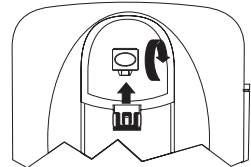

3. Slide the retainer back into the base.

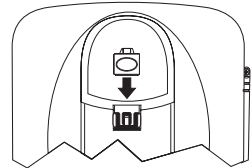

▼ Mounting on a Standard Wall Plate

The phone is designed to be mounted on a standard AT&T or GTE wall plate.

1. Plug the AC Adapter into the base.

2. Place the AC Adapter cord inside the left channel cord holder.

3. Plug a short telephone cord into the phone and the wall plate jack.

4. Place the base on the two posts of the wall plate and slide downward to secure.

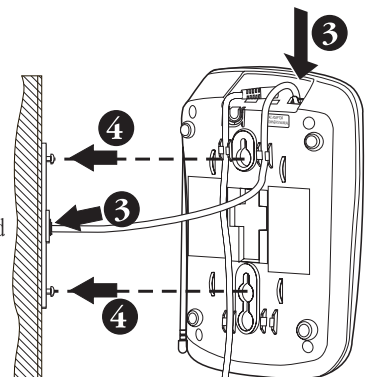
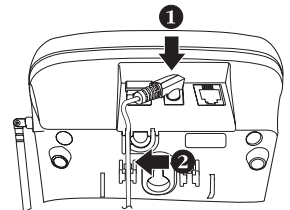

5. Raise the antenna on the base.

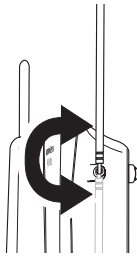

6. Plug the AC Adapter into a standard 120V AC wall outlet that is not controlled by a wall switch.

▼ Mounting Directly on a Wall

If you do not have a standard wall plate, you can mount the phone directly on a wall. Before mounting your cordless telephone, consider the following:

Select a location away from electrical cables, pipes, or other items behind the mounting location that could cause a hazard when inserting screws into the wall.

Make sure the wall material is capable of supporting the weight of the base and handset; otherwise, damage to the unit could result.

Use #10 screws with anchoring devices suitable for the wall material where the base will be placed.

1. Insert the screws, with their appropriate anchor device, 3 5/16 inches apart. Allow 3/16 of an inch between the wall and screw heads for mounting the phone.

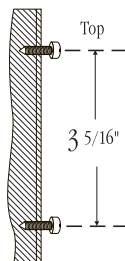

2. Plug the AC Adapter into the base.
3. Place the AC Adapter cord inside the left channel cord holder.

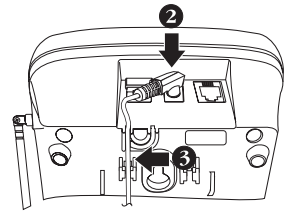

4. Plug one end of the long telephone cord into the **TEL LINE** jack on the base.
5. Place the telephone cord into the right channel cord holder.

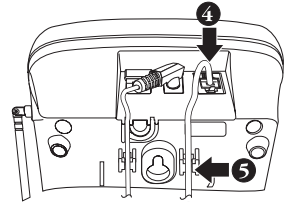

6. Place the base on the screws and push down until it's firmly seated.

After the unit is mounted, raise the antenna.

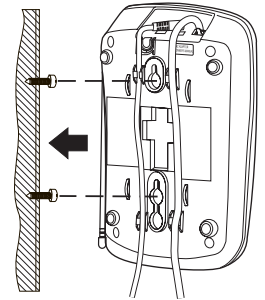

7. Plug the other end of the telephone line into the telephone wall jack.

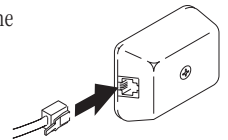

8. Plug the AC Adapter into a standard 120V AC wall outlet that is not controlled by a wall switch.



Use only the AC adapter that came with the phone.

Setting Up Your Phone

Extending the Antenna

Before using your phone, be sure to raise its antenna to the vertical position.

Installing the Battery Pack

NOTE

The memory backup feature allows up to 3 minutes after disconnecting the old battery pack to install a new one without losing any phone numbers stored in memory.

1. Remove the handset battery cover.

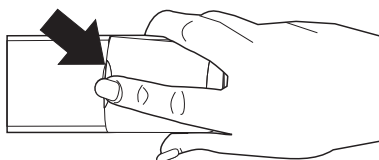

2. Plug the battery's cable into the handset.

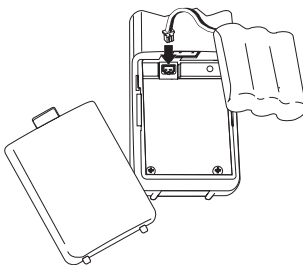

NOTE

The plastic connectors will fit together only one way. Make sure the battery's connector is properly aligned.

3. Replace the battery cover.

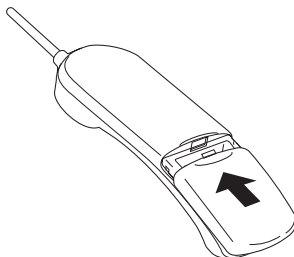

▼ Charging the handset

Place the handset on the base to charge.

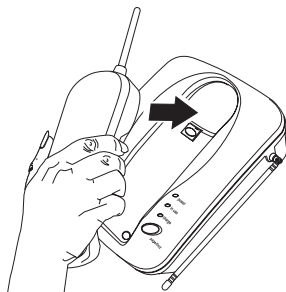

▼ Low Battery Indicator

When the Battery Pack in the handset is low and needs to be charged, the batt low led flashes every 3 seconds.

If this occurs while you are on the phone, you hear an alert tone. Complete your call as quickly as possible, and return the handset to the base for charging.

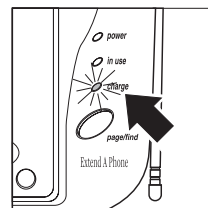

▼ Cleaning the Battery Contacts

To maintain a good charge, it is important to clean all battery contacts on the handset and base about once a month. Use a pencil eraser or other contact cleaner. Do not use any liquids or solvents.

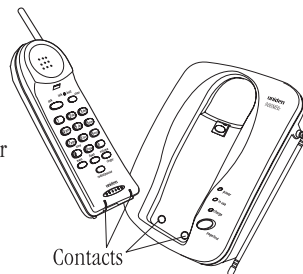

Adjusting Ringer/Volume Controls

▼ Ringer Tone and Volume

1. While the phone is not in use, press **ringer**.
2. The phone has two ringer tones, each with two volume levels. Press **ringer** again until you select the ringer tone and volume you want.

▼ Setting the Receiver Volume

1. While you are on a call, press **volume**.
2. The phone has two receiver volume levels, one soft and one loud. Press **volume** again until you select the receiver volume you want.

EXP93 Charging Cradle

The extra charging cradle is not a replacement for the base. Put it in a different room than the base so you can recharge the phone on the cradle.

Example: You want to use your cordless phone in the kitchen (an area of high interference). Connect the base in a room with low interference (without appliances, televisions or computers); then, put the charging cradle in the kitchen.

1. Plug the charging cradle AC adapter connector into the DC input jack on the back of the charging cradle.
2. Wrap the AC adapter cord around the strain relief. Set the cradle on a flat surface.

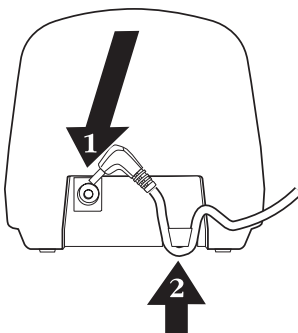

Use only the AC adapter that came with the charging cradle.

3. Plug the AC adapter into a standard 120V AC wall outlet that is not controlled by a wall switch.
4. Place the handset upright in the charging cradle as shown to the right.

The charge LED lights while the unit is charging.

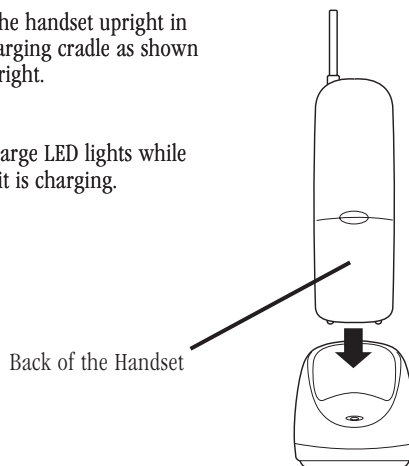

The charging cradle does not reset the digital security code (refer to page 2.)

Using Your Phone

Making and Receiving Calls

	Handset on base	Handset off base
Answer call	When the phone rings, remove the handset from the base. (AutoTalk)	Press any key.
Make call	<ol style="list-style-type: none"> 1. Remove the handset from the base and press talk. 2. The talk LED lights. 3. Listen for the dial tone. 4. Dial the number. 	<ol style="list-style-type: none"> 1. Pick up the handset and press talk. 2. The talk LED lights. 3. Listen for the dial tone. 4. Dial the number.
Hang up	Return handset to the base. (AutoStandby)	Press talk .
Redial	Pick up the handset and press redial .	Pick up the handset and press redial .

Storing a Number in Memory

1. Remove the handset from the base and press **mem**.
2. The talk LED flashes and you hear a beep.
3. Enter the number you want to store (up to 16 digits).

NOTE

You have 20 seconds after pressing **mem** to enter the number you wish to store. Otherwise, an error tone will sound.

4. Press **mem**.
5. Enter a number (0-9) for the memory location you want.

NOTE

If you select any key other than 0-9, the handset will beep rapidly and no number will be stored

6. You hear a long beep and the talk LED goes out indicating the number has been stored successfully.
7. Write the stored number and its memory location number on one of the enclosed stickers.

Storing Mixed Tone/Pulse Numbers

If your phone is set up for pulse dialing, you can store a mixed mode number (up to 16 digits) to easily access long distance services.

1. Remove the handset from the base and press **mem**.
2. The talk LED flashes and you will hear a beep.
3. Enter the number to be dialed in pulse mode.

NOTE

You have 20 seconds after pressing **mem** to enter the number you wish to store. Otherwise, an error tone will sound.

4. Press the **tone** button on the handset. The **tone** button counts as one digit.

5. Enter the number to be dialed in tone mode.
6. Press **mem** and a number (0-9) for the memory location you wish to use.

NOTE

If you select any key other than 0-9, the handset will beep rapidly and no number will be stored

7. You hear a long beep and the talk LED goes out.
8. Write the stored number and its memory location number on one of the enclosed stickers.

Dialing a Stored Number

To dial a number stored in memory, press **talk**, then press **mem** and the memory location (0-9). Your phone will dial the stored number.

NOTE

If you select a memory location that does not have a stored number, the handset will beep rapidly and will not dial.

Chain Dialing

On certain occasions, after dialing a number, you may be requested to enter a special access code, such as when performing a banking transaction.

1. Store the access code into one of the memory locations (0-9).
2. Dial the main number.
3. Press **mem** and the memory location of the access code at the appropriate time.

Erasing a Stored Number

1. Remove the handset from the base.
2. Press **mem** twice.
3. Press the memory location number (0-9) you want to clear.
You will hear a long beep confirming that you have erased the number.

Selecting a Different Channel

If you have more than one cordless phone in your house, they must be set to different channels. This function works only when the phone is in use.

The **chan** button on the handset allows you to choose between 40 factory set channels. During the course of a conversation if you hear static or noise which makes it difficult to hear the caller:

- Press **chan**.
- The talk LED flashes, indicating the phone is changing to another channel.

Using the Flash Button

Use **flash** to send a timed hook-flash for accessing services such as call waiting.

Press the **flash** button on the handset during your conversation.

Using the Page/Find Feature

The Page/Find feature sends a signal from the base to the handset causing it to beep. This is useful for locating the handset when it is away from the base.

1. Press **page/find** on the base.
2. The handset beeps several times.



The paging feature does not work when the phone is in use

Troubleshooting

If your EXP90 Series cordless telephone is not performing to your expectations, please try these simple steps. If you are still unable to resolve the problems, contact your place of purchase.

Caution: Do not attempt to service this unit yourself. All service must be done by qualified service personnel.

Problem	Suggestion
Charge light won't come on when handset is placed in base.	<ul style="list-style-type: none">• Make sure the AC adapter is plugged into the base and wall outlet.• Make sure the handset is properly seated in the base.• Make sure the rechargeable battery pack is properly placed in the handset.• Make sure that the charging contacts on the handset and on the base are clean.
The audio sounds weak and/or scratchy.	<ul style="list-style-type: none">• Make sure that the base antenna is in a vertical position.• Move the handset and/or base to a different location away from metal objects or appliances and try again.
Can't make or receive calls.	<ul style="list-style-type: none">• Check both ends of the base telephone line cord.• Make sure the AC adapter is plugged into the base and wall outlet.• Disconnect the AC adapter for a few minutes, then reconnect it.• Place the handset back on the charging cradle for a few seconds. The status LED will blink indicating that the phone has been reset.
Handset doesn't ring or receive a page..	<ul style="list-style-type: none">• The Nickel-Cadmium battery pack may be weak. Charge the battery on the base unit for 15-20 hours.• The handset may be too far away from the base unit.• Place the base unit away from appliances or metal objects.• Place the handset back on the charging cradle for a few seconds. The status LED will blink indicating that the phone has been reset.

Specifications

General

Frequency Control	Phase Locked Loop
Modulation	FM
Operating Temperature	-10° to 50° C, 14° to 122° F

Base

Transmit Frequency	925.999 ~ 927.952 MHz (40 Channels)
Power Requirements	9V 210mA (from AC Adapter)
Size	5.3 in. W X 2.2 in. D X 7.7 in. H
Weight	Approximately 20 oz.

Handset

Transmit Frequency	902.078 ~ 904.030 MHz (40 Channels)
Size	2.2 in. W X 2 in. D X 9.75 in. H
Weight	Approximately 10 oz.

Battery

Capacity	600 mAh, 3.6V
Talk Mode	7 hours
Standby Mode	14 days

Specifications shown are typical and subject to change without notice.

THANK YOU

FOR PURCHASING A UNIDEN PHONE!

Uniden

Covered under one or more of the following U.S. patents:

4,511,761 4,523,058 4,595,795 4,797,916 5,426,690

5,650,790 5,660,269 5,661,780

©1998 Uniden America Corporation

All rights reserved. Manufactured in China

UCZZ01417ZZ

Free Manuals Download Website

<http://myh66.com>

<http://usermanuals.us>

<http://www.somanuals.com>

<http://www.4manuals.cc>

<http://www.manual-lib.com>

<http://www.404manual.com>

<http://www.luxmanual.com>

<http://aubethermostatmanual.com>

Golf course search by state

<http://golfingnear.com>

Email search by domain

<http://emailbydomain.com>

Auto manuals search

<http://auto.somanuals.com>

TV manuals search

<http://tv.somanuals.com>