



EXS 2050

# OWNER'S MANUAL

Digital Spread  
Spectrum Provides  
Long Range, Clear  
Sound, and Secure  
Communication

**Uniden®**

## Introduction

Thank you for choosing the Uniden EXS 2050 cordless telephone. This phone is designed for reliability, long life, and outstanding performance utilizing the latest 900 MHz Spread Spectrum technology.

**Note: Some illustrations in this manual may differ from the actual unit for explanation purposes.**

## Features

- 900 MHz Spread Spectrum Technology
- Digital Answering Device
- 10 Memory Dial Locations
- 32 Digit Redial
- Flash and Pause
- Redial
- Pulse / Tone Dialing
- Page
- 6 Hour Talk Time
- 10 Day Standby Battery Time
- Handset Earpiece and Ringer Volume Control
- Hearing Aid Compatible
- Headset Compatible

**Digital Spread Spectrum Technology** utilizes a “wider frequency band” vs. a “single narrow band” used in standard digital transmissions. The result is a more secure conversation with the clarity of digital sound, extended range, and minimal interference from other cordless phones.

**Random Code™** digital security automatically selects one of over 65,000 codes for the handset and base.

These features enhance your phone’s security and prevent unauthorized calls as a result of your phone being activated by other equipment.

# Controls and functions

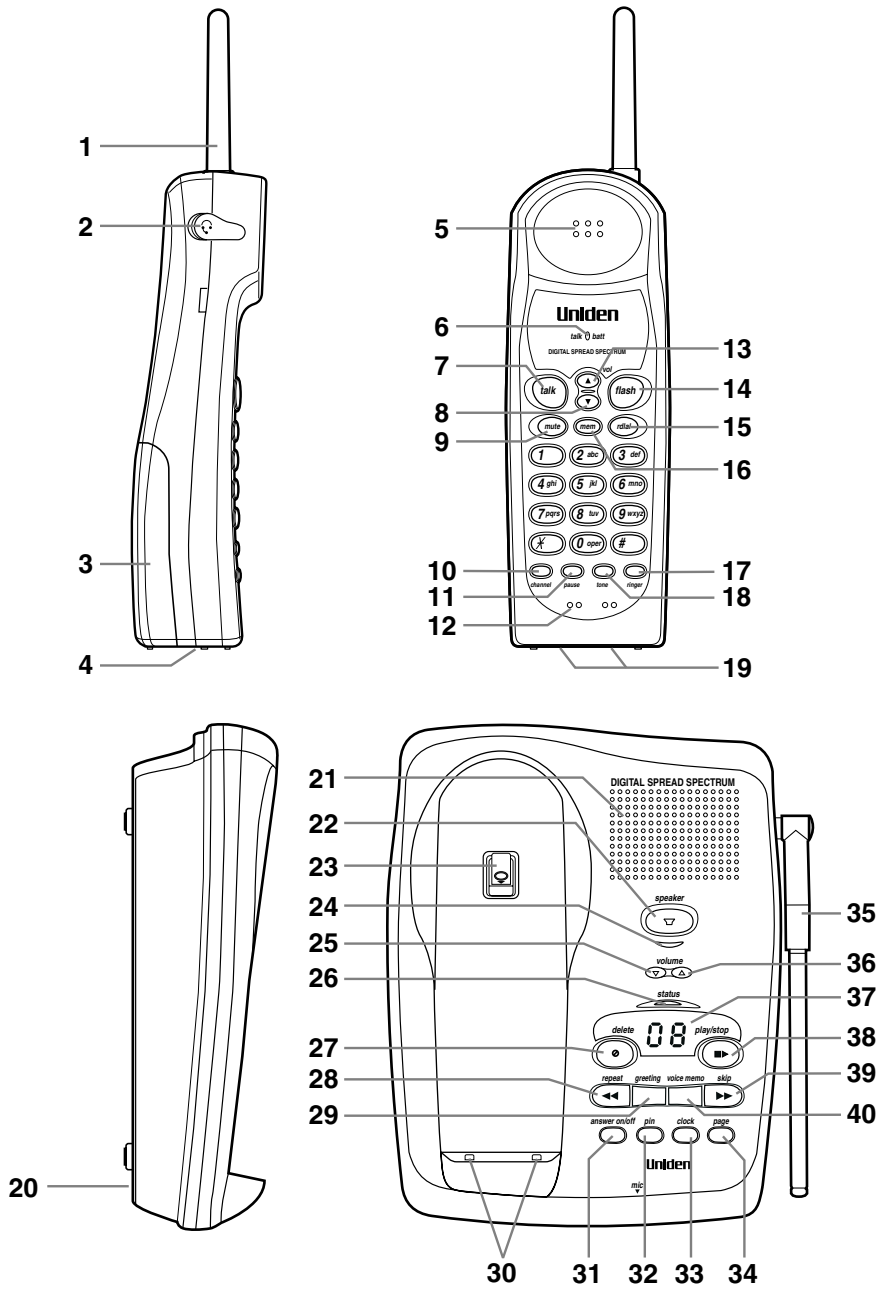

1. Handset antenna
2. Headset jack cover
3. Handset battery compartment
4. Ringer on/off switch
5. Handset speaker
6. Talk/Batt LED
7. Talk key
8. Volume down key
9. Mute key
10. Channel key
11. Pause key
12. Handset microphone
13. Volume up key
14. Flash key
15. Redial key
16. Memory key
17. Ringer key
18. Tone key
19. Handset charge contacts
20. Base microphone
21. Base speaker
22. Speaker key
23. Handset retainer clip
24. Speaker LED
25. Volume down key
26. Status LED
27. Delete key
28. Repeat key
29. Greeting key
30. Base charge contacts
31. Answer on/off key
32. Pin code key
33. Clock key
34. Page key
35. Base antenna
36. Volume up key
37. LED display
38. Play/Stop key
39. Skip key
40. Voice memo record key
41. Record time switch
42. Ring time switch
43. Base ringer switch
44. Pulse-Tone switch
45. DC power input
46. Tel line jack

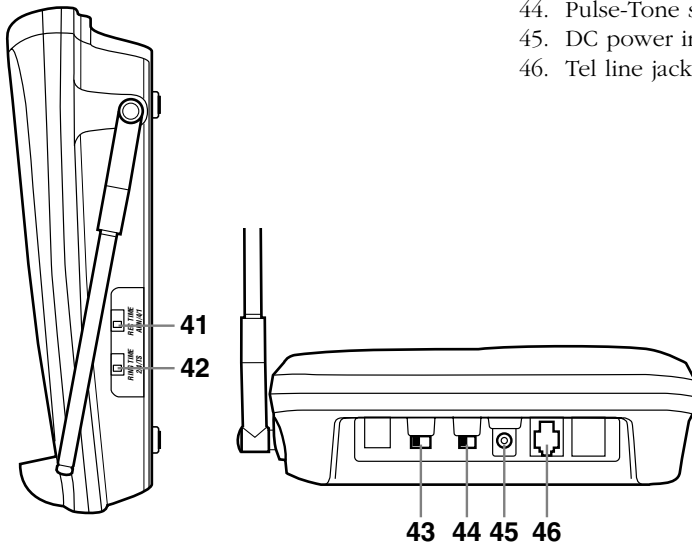

## Contents

Introduction / Features.....	inside front cover
Controls and Functions .....	inside front cover
<b>Getting Started</b>	
Read this first.....	3
Step 1: Checking the package contents .....	4
Step 2: Setting up the base unit .....	5
Mounting the base unit on a wall .....	8
Step 3: Installing the handset battery pack.....	10
<b>Basics</b>	
Making a call .....	12
Receiving a call .....	13
Ringer mute .....	13
Adjusting the volume .....	14
Flash and Call Waiting .....	15
Redialing a call .....	15
Mute .....	15
Traveling out-of-range.....	16
Using the page feature.....	16
<b>Memory Dialing</b>	
Storing phone numbers .....	17
Making calls with memory dialing.....	18
Chain dialing.....	18
Erasing a stored phone number.....	19
<b>3-way Conference Features</b>	
3-way conferencing.....	20
<b>Integrated Answering Device</b>	
Features.....	21
Setting up your answering system .....	22
Using your answering system .....	26
<b>Additional Information</b>	
Changing the digital security code.....	32
Installing the beltclip.....	33
Headset installation .....	33
Note on power sources .....	34
Maintenance.....	34
<b>Troubleshooting</b> .....	35
<b>Index</b> .....	38

Getting Started

Basics

Memory Dialing

3-way  
Conference  
Features

Integrated  
Answering  
Device

Additional  
Information

Troubleshooting

Index

**Read this first**

This cordless telephone must be set up before use. Follow these steps;

**Step 1** (page 4)

Unpack and check the telephone and accessories.

**Step 2** (page 5 to 9)

Next, choose the best location to set up the base unit.

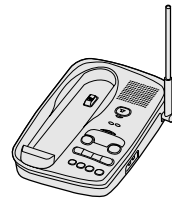

**Base unit**

**Step 3** (page 10 to 11)

Then, insert the battery pack into the handset. You have to charge the battery pack for 15-20 hours before using the phone.



**Handset**

**About the digital security code**

This cordless telephone uses a digital security code to prevent unauthorized access to your base unit. This security code prevents other cordless handsets from making calls through your base unit. A random security code will be assigned automatically between your base unit and handset when you charge the battery pack for the first time.

## Checking the package contents

Make sure you have received the following items in the package. If any of these items are missing or damaged, contact the **Uniden Parts Department** (see below).



• Base unit



• Handset

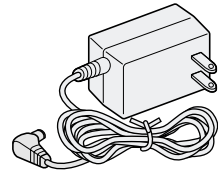

• AC adapter (AD-420)

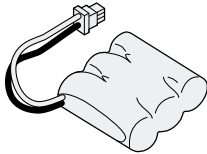

• Rechargeable battery pack (BT-905)

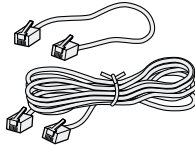

• Telephone line cord (Long, Short)

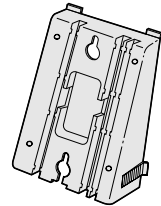

• Wall mount adapter

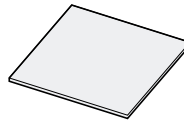

• Memo sticker

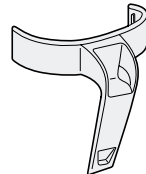

• Beltclip

- This Owner's Manual
- Precautions and Important Safety Instructions
- Registration Card

### Uniden Parts Department

(800) 554-3988

Hours: M-F 8:30 AM to 5:00 PM CST.

We can also be reached on the web at [www.uniden.com](http://www.uniden.com).

## Setting up the base unit

Do the following steps.

- Choose the best location
- Connect the base unit
- Choose the dialing mode

### Choose the best location

Before choosing a location for your new phone, read the INSTALLATION CONSIDERATIONS included in the PRECAUTIONS AND IMPORTANT SAFETY INSTRUCTIONS brochure. Here are some important guidelines you should consider:

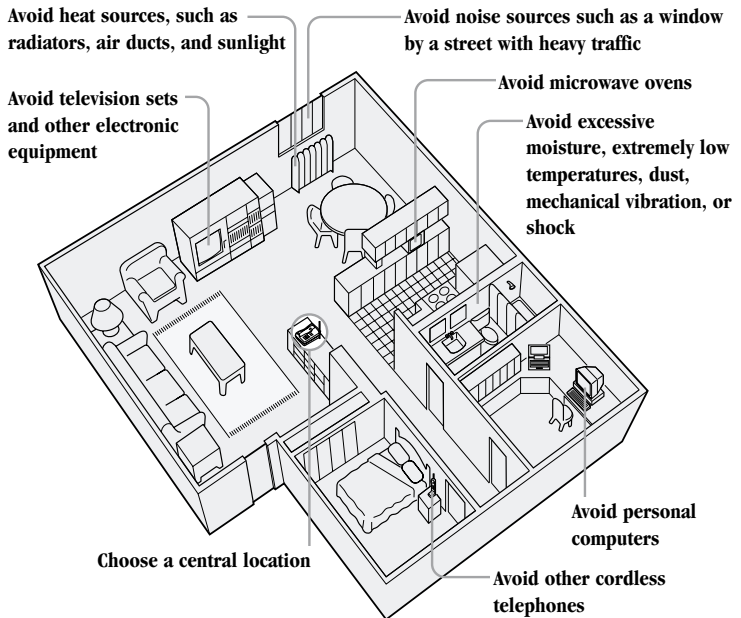

- You should charge your handset for 15-20 hours before using the phone.
- The location should be close to both a phone jack and continuous power outlet which is not switchable.
- Keep the base and handset away from sources of electrical noise such as motors and fluorescent lighting.
- Be sure there is sufficient space to raise the base antenna fully vertical.
- The base can be placed on a desk, tabletop or mounted on a standard wall plate.



## Connect the base unit

If you want to install the base unit on the wall, see page 8.

### NOTE

Place the power cord so it does not create a trip hazard, or where it could become chafed and create a fire or electrical hazard.

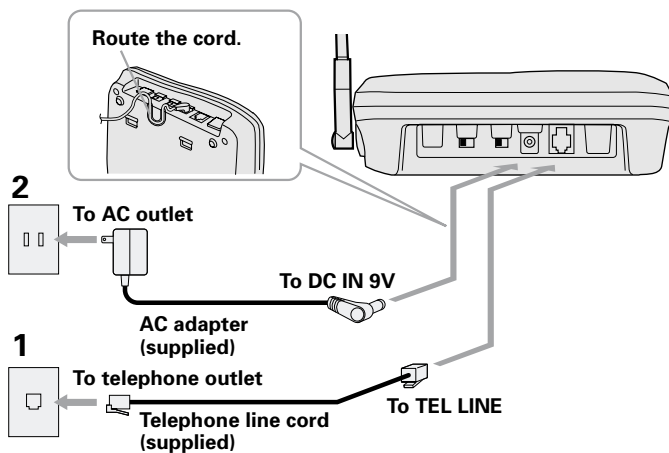

- 1** Connect the telephone line cord to the **TEL LINE** jack and to a telephone outlet.
- 2** Connect the AC adapter to the **DC IN 9V** jack and to a standard 120V AC wall outlet.
- 3** Set the base unit on a desk or tabletop and place the handset on the base unit. Then raise the antenna to a vertical position.

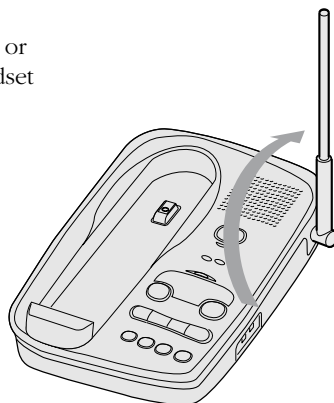



Use only the supplied AD-420 AC adapter. Do not use any other AC adapter.

**Polarity of the plug**

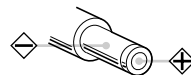

Connect the AC adapter to a continuous power supply.



Place the base unit close to the AC outlet so that you can unplug the AC adapter easily.



If your telephone outlet isn't modular, contact your telephone company for assistance.

**Modular**



**Choose the dialing mode**

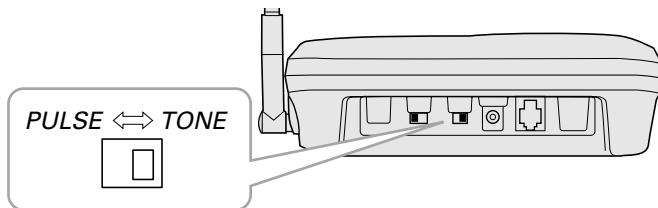

Depending on your dialing system, set the **PULSE-TONE** switch as follows:

<b>If your dialing system is</b>	<b>Set the switch to</b>
Tone	<b><i>TONE</i></b>
Pulse	<b><i>PULSE</i></b>

**If you aren't sure of your dialing system**

Make a trial call with the **PULSE-TONE** switch set to **TONE**. If the call connects, leave the switch as is; otherwise, set to **PULSE**.

## Mounting the base unit on a wall

### Standard wall plate mounting

This phone can be mounted on any standard telephone wall plate.

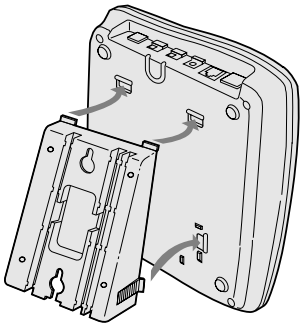
- 

1 Snap the wall mount adapter into the notches on the base.
  - 

2 Plug the telephone line cord to the **TEL LINE** jack and the AC adapter to the **DC IN 9V** jack.
  - 

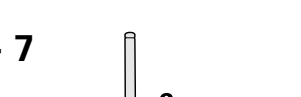
3 Plug the telephone line cord into the telephone outlet.
  - 

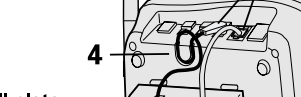
4 Wrap the AC adapter cord inside the molded wiring channel. Then wrap the cord around the strain relief notch.
  - 

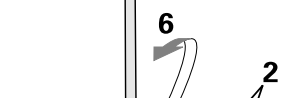
5 Plug the AC adapter into a standard 120V AC wall outlet.
  - 

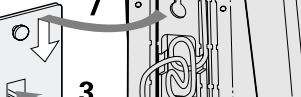
6 Raise the antenna to a vertical position.
  - 

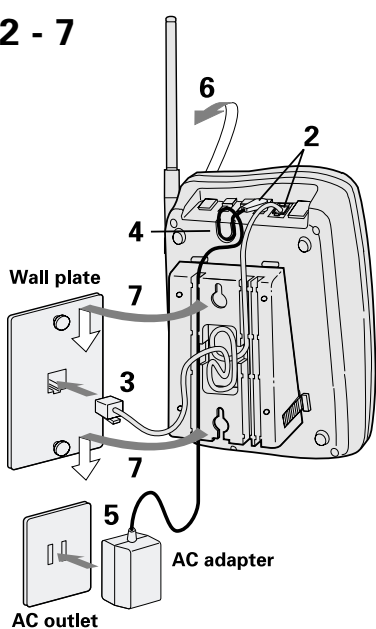
7 Align the mounting slots on the base with the mounting posts on the wall. Push in and down until the phone is firmly seated.
- 

## NOTE

If you have wall mounted the base, you must remove the beltclip to charge the handset facing forward.

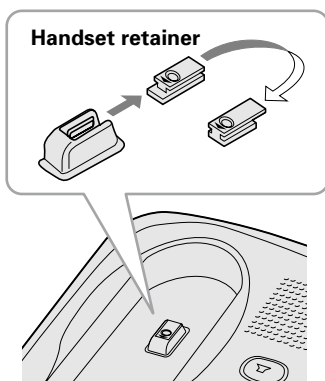

- 8 On the base unit, pull the handset retainer out of the slot. Rotate it clockwise 180 degrees.
- 9 Flip the retainer from front to back. Slide it back into the slot so that the lip of the retainer is up and the ▼ symbol is pointed down. The retainer holds the handset in place.

## Direct wall plate mounting

If you don't have a standard wall plate, you can mount your phone directly to the wall. Before doing this, consider the following:

- Avoid electrical cables, pipes, or other items behind the mounting location, that could cause a hazard when inserting screws into the wall.
- Try to mount your phone within 10 - 15 feet of a working phone jack to avoid excessive cord lengths.
- Make sure the wall material is capable of supporting the weight of the base and handset.
- Use #10 screws (minimum length of 1-3/8 inches) with anchoring devices for the wall material where the base unit will be placed.

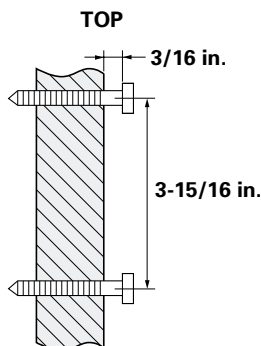

- 1 Insert two mounting screws into the wall, (with their appropriate anchoring device), 3-15/16 inches apart. Allow about 3/16 of an inch between the wall and screwheads for mounting the phone.
- 2 Refer to steps 1 through 9 on page 8 and 9 to mount the telephone.

## Installing the handset battery pack

Charge the battery pack for 15-20 hours before you start using your phone.

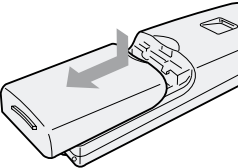
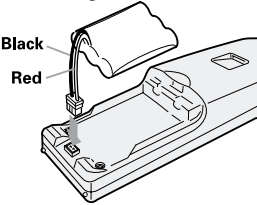
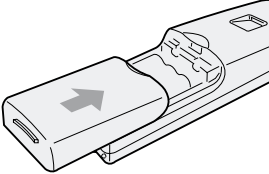
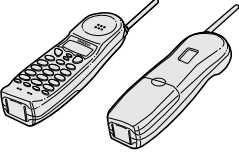
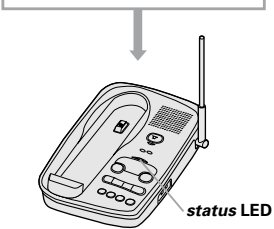
-  **1** Press in on the battery cover release and slide the cover down until it comes off.
-  **2** Connect the battery pack connector with the correct polarity (black and red wires), then insert the battery pack into the battery compartment.
-  **3** Slide the battery cover forward until it snaps into place.
-  **4** Place the handset on the base.
-  **5** Make sure that the "**status**" LED lights. If the LED doesn't light, check to see that the AC adapter is plugged in and that the handset makes good contact with the base charging contacts.



Use only Uniden Battery (BT-905) supplied with your phone.

## NOTE

Even when the battery pack is not being used, it will gradually discharge over a long period. For optimum performance, be sure to return the handset to the base unit after a telephone call for charging the battery.

### Battery use time (per charge)

From fully charged

- Six hours continuous use
- Ten days when the handset is in the standby mode

### When the battery charge becomes low

When the voltage of battery pack in the handset is very low and needs to be charged, the phone is programmed to eliminate functions in order to save power. If the battery charge becomes low, **talk/batt** LED blinks. If the phone is in use, the handset beeps. Complete your conversation as quickly as possible and return the handset to the base unit for charging.

### Cleaning the charging contacts

To maintain a good charge, it is important to clean the charging contacts on the handset and base unit with a dry cloth about once a month.

**Do not use any liquids or solvents.**

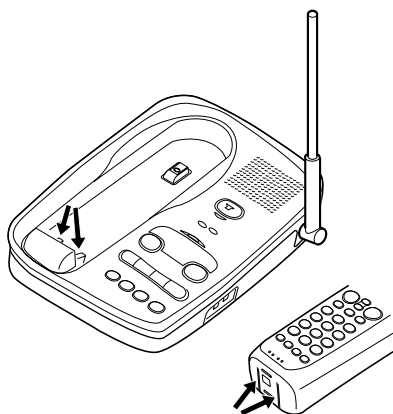

## Making a call



- 1 Press **(talk)** . The **talk/batt** LED lights.
- 2 Dial the phone number.
- 3 To hang up, press **(talk)** or return the handset to the base.

### NOTE

If the **talk/batt** LED does not stop flashing, place the handset on the base for at least three seconds and make a call again.

### Other Operations

To	Do this
To adjust the ear speaker volume	Press <b>(▲)</b> or <b>(▼)</b> during the call.
To temporarily switch to tone dial (When the base is set to pulse mode)	Press <b>(tone)</b> . The following numbers will be sent as tone dialing.
To improve reception	Press <b>(channel)</b> .

## Receiving a call

### NOTE

When you receive a call during a page or memory dialing operation, press **(talk)** to answer the call.

### From the handset

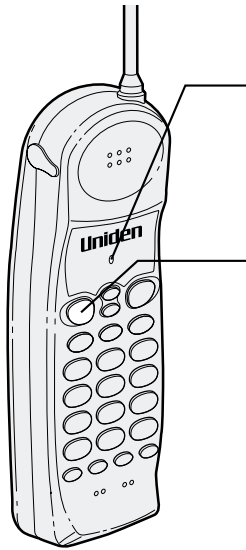

#### Handset on the base

- 1** The phone rings. The **talk/batt** LED flashes.
- 2** Pick up the handset and begin speaking.
- 3** To hang up, press **(talk)** or return the handset to the base.

#### Handset off the base

- 1** Phone rings. The **talk/batt** LED flashes.
- 2** Press **(talk)** or any key (except **(mute)**) and begin speaking.
- 3** To hang up, press **(talk)** or return the handset to the base.

### From the base

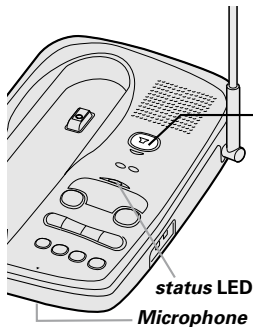

- 1** The phone rings. The **status** LED on the base flashes.
- 2** Press **(speaker)** and begin speaking.
- 3** To hang up, press **(speaker)**.

### NOTE

The base microphone is located under the phone. Position yourself as near to the base as possible and speak clearly.

## Ringer mute

You can temporarily mute the handset's ringer by pressing **(mute)** when the phone rings. You may still press **(talk)** to answer the call.



## Adjusting the volume

### Handset ringer tone and volume

Press **(ringer)** repeatedly in standby mode to select one of four types ringer tone and volume combinations.

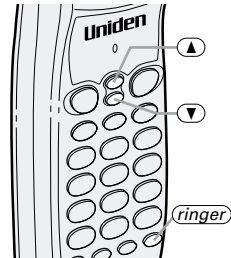

### Ringer on/off switch

This switch turns the handset ringer on or off.

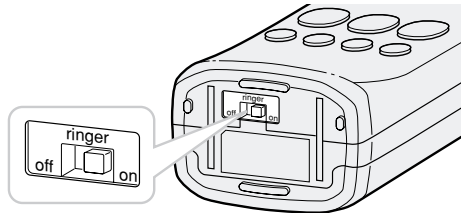

### Handset earpiece volume

The phone has four earpiece volume levels, Normal, Medium, High, and Loud. Pressing **(▲)** or **(▼)** during a telephone call will change the earpiece volume of the handset. This setting will remain in effect after the telephone call has ended.

When you press **(▲)** in Loud mode or press **(▼)** in Normal mode, error sound beeps.

### Base ringer switch

This switch turns the base ringer on or off.

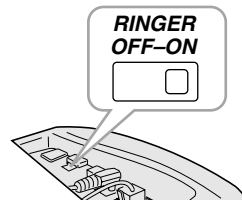

### Base speaker volume

To control the speaker volume of the base, adjust the **(volume▲)** and **(volume▼)** button as desired.

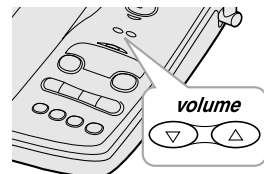

## Flash and Call Waiting

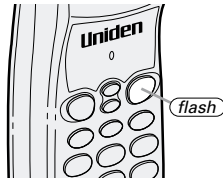

If you have “Call Waiting” service and a call waiting tone sounds while you are on a call, press **(flash)** to accept the waiting call. There is a short pause, then you will hear the new caller. To return to the original caller, press **(flash)** again.

## Redialing a call

The last phone number dialed can be quickly redialed.

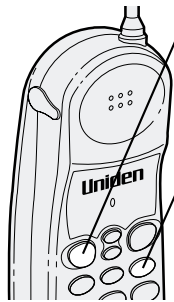

- 1 Press **(talk)**. The **talk/batt** LED lights.
- 2 Press **(redial)**.
- 3 To hang up, press **(talk)** or place the handset on the base.

### NOTE

If the recently dialed number exceeds 32 digits, only the first 32 digits are retained for redialing.

## Mute

You can turn off the handset microphone and temporarily mute the ringer.

### When speaking on the handset

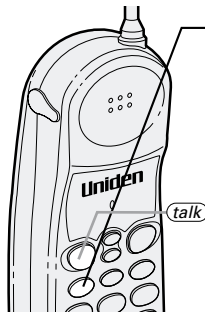

- 1 Press **(mute)** during a telephone call. The **talk/batt** LED blinks. The other party will not be able to hear you although you can hear them.
- 2 To cancel mute, press **(talk)** or **(mute)** again.

### When the phone is ringing

Press **(mute)** when the phone rings. The ringer sound turns off. You may still press **(talk)** to answer the call.

## Traveling out-of-range

During a call, as you begin to move your handset too far from your base unit, noise increases. If you pass the range limits of the base unit, your call will terminate within 30 seconds.

## Using the page feature

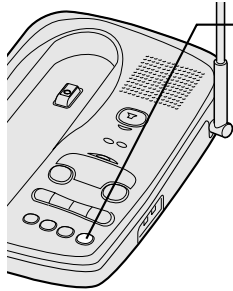

- 1 To locate the handset (while it's off the base), press **(page)** on the base. The handset beeps for 5 seconds.

### NOTE

If you cancel the page by pressing **(talk)**, press **(talk)** again to return to standby.

### NOTE

Press and hold **(page)** for more than 2 seconds to page the handset for a minute. Press any key or return the handset to the base to cancel the page.

If you hold down **(page)** for more than a minute, the handset beeps until you release **(page)**.

## Storing phone numbers

Your EXS 2050 stores up to 10 numbers in the handset.

### NOTE

You must press a key within 20 seconds or the phone will return to standby. If you return the handset in the cradle, the phone will return to standby too.

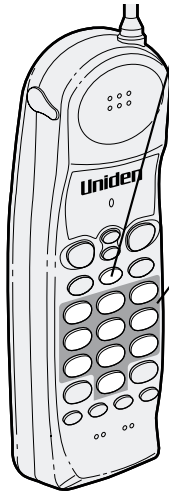

- 1** Press **mem** while in standby mode. The **talk/batt** LED flashes.
- 2** Dial the number you wish to store (up to 20 digits).
- 3** Press **mem** again.
- 4** Enter a number key (0 - 9) to select the memory location where you wish to store the number.
- 5** The **talk/batt** LED goes out and the confirmation beep indicates the number has been stored.

### DIALING

### NOTE

Press **pause** to enter a pause in the dialing sequence. The pause feature is useful for long distance calling, credit card dialing, or sequences that require a pause between digits.

### NOTE

Use the supplied memo sticker to write stored numbers.

# MEMORY

## Making calls with memory dialing

### Memory dialing

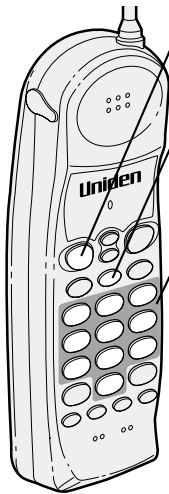

- 1** Press **(talk)**. The **talk/batt** LED lights.
- 2** Press **(mem)**.
- 3** Enter a number key (0 - 9) to select the memory location you wish to dial.
- 4** To hang up, press **(talk)** or return the handset to the base.

### Chain dialing

On certain occasions after dialing a number, you may be requested to enter an access code, such as your account number. You can enter this number into a memory location for later use by doing the following:

- 1) Store the access code into one of the memory locations (0-9) following the steps on page 17.
- 2) Dial the party or service main number.
- 3) When you need to enter the special number, press **(mem)** followed by the memory location (0-9).

## Erasing a stored phone number

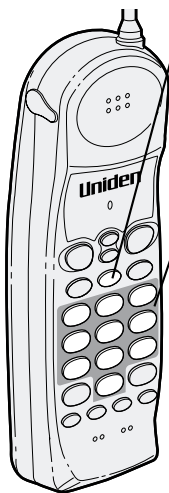

- 1** Press **mem** in the standby mode.  
The **talk/batt** LED flashes.
- 2** Press **mem** again.
- 3** Enter a memory location number (0 - 9) you wish to delete.  
A confirmation beep indicates the number has been erased.



Dialing is possible only from the handset during the 3-way conversation.



If you pick up the handset from the base while speaking on the base, the call will be transferred to the handset.

## 3-way conferencing

The Uniden EXS 2050 permits 3-way conversations between the handset, base and outside line.

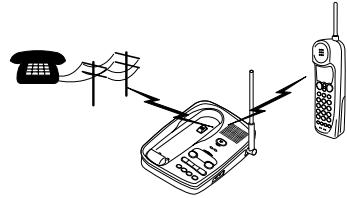

### When speaking on the handset

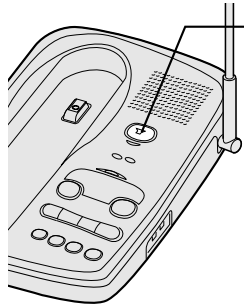

- 1 Press **speaker** on the base to join the 3-way conversation.
- 2 To hang up, press **speaker** on the base. The handset will still be connected to the call.

### When speaking on the base

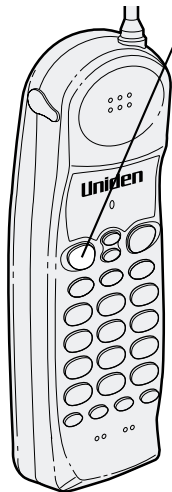

- 1 Press **talk** on the handset to join the 3-way conversation.
- 2 To hang up, return the handset to the base, or press **talk** on the handset. The base will still be connected to the call.

## Integrated answering device

The EXS 2050 has a built-in answering system that answers and records incoming calls.

You can also use your answering system to record a conversation, leave a voice memo message for others who use the phone, or to announce a special message to callers when you're away from your phone.

### Features

- Digital Tapeless Recording
- 15 minutes of Recording Time
- Selective Greetings (Outgoing Messages)
- Time and Day Stamp
- Remote Message Retrieval and Room Monitor
- Toll Saver
- Conversation Recording

Digital Tapeless Recording allows you to quickly review, save or delete the messages. You'll never have to worry about a tape wearing out, jamming, or resetting improperly.

The Integrated Answering System is easy and convenient to use, but please read through all of the instructions carefully.



## NOTE

If you have not recorded your personal outgoing message when you turn the answering system on, the preset message is automatically set. To set your personal message, see page 23.

## Setting up your answering system

### Turning the answering system on/off

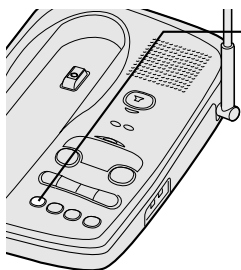

- 1 To turn the answering system on, press **answer on/off**. The current greeting message is played and a tone sounds.
- 2 To turn the answering system off, press **answer on/off** again.

## NOTE

When the answering system is full, **FL** displays on the base and the system announces "No remaining time". You should delete some messages so that the system can record new messages.

### Setting the clock

The clock on the EXS 2050 Answering System starts when power is applied to the base. Follow these steps to set the clock to the correct time.

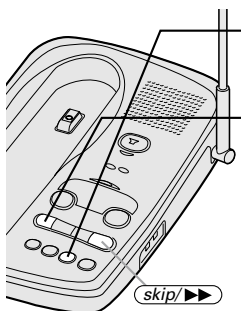

- 1 Press and hold **clock** until a tone sounds.
- 2 First, press **skip** or **repeat** repeatedly until the correct day of the week is announced. (Numbers 1 through 7 display on the base as each day is announced.) Press **clock** again to select the day.
- 3 Next, press **skip** or **repeat** repeatedly until you hear the correct hour setting. Numbers 1 through 12 display on the base as each hour is announced. Press **clock** again to select the correct time.
- 4 Press **skip** or **repeat** repeatedly until you hear the correct time setting. Numbers 1 through 59 display on the base as each minute is announced. Press **clock** again to select the correct time.

## NOTE

Holding **skip** or **repeat** to scroll through days, hours, minutes, etc.

## NOTE

If you don't set the clock within two minutes, the system returns to standby.

- 5 The LED displays *A* or *P*. Press **(skip ►►)** or **(repeat ◀◀)** until you hear the correct AM/PM setting.
- 6 Press **(clock)** again to end the time/day setting. The EXS 2050 announces the time that you have set.

## Setting your greeting

When you receive a call, the answering system automatically plays either a preset message or your own greeting.

### ▼ Preset Message

The following message is prerecorded:

"Hello, no one is available to take your call. Please leave a message after the tone."

### ▼ Recording a personal outgoing message (Greeting)

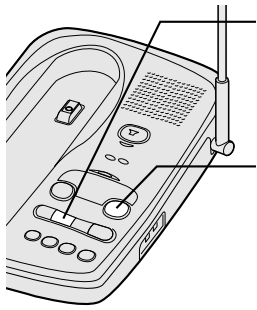
- 
- 1 Press and hold **(greeting)** until you hear a tone. Start recording your message immediately after you hear the tone end.
  - 2 When you finish recording your message, press **(greeting)** or **(play/stop)**. A tone sounds and your message plays back on the phone.

### ▼ Choosing between the two outgoing messages

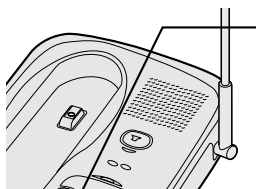
- 
- 1 Press **(greeting)** to play the outgoing message.
  - 2 Press **(greeting)** again while the message is played. This switches between the two options.

### NOTE

You can record a greeting up to 30 seconds.

### NOTE

Position yourself as near to the base as possible and speak clearly when recording your outgoing message.

## Selecting the message record time

You can set your answering system to record messages between one to four minutes long.

One minute option:  
move the **REC TIME** switch to **1**.

Four minute option:  
move the **REC TIME** switch to **4**.

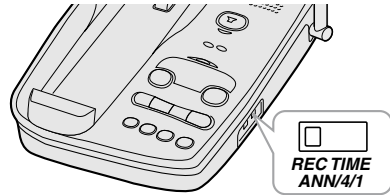

### ▼ Announce only feature:

The announce only feature plays an outgoing message, but it will not allow the caller to leave a message. Move the **REC TIME** switch to the **ANN** position.

The message counter LED displays "9" when system is on standby.

The prerecorded outgoing message for Announce only feature is:

"Hello, no one is available to take your call."

## Selecting a PIN code

To play your messages from a remote location, you will need to enter a two-digit Personal Identification Number (PIN) code (00-99). To select a PIN, perform the following steps.



Press and hold **(skip ►►)** or **(repeat ◄◄)** to scroll through numbers on the display.

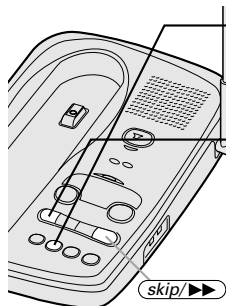

- 1** On the base, press and hold **(pin)** until a tone sounds and the LED displays **00**.
- 2** To set the first number, press **(skip ►►)** or **(repeat ◄◄)** repeatedly to scroll from 0 to 9. When the desired number appears in the display, press **(pin)**.
- 3** To set the second number, press **(skip ►►)** or **(repeat ◄◄)** to scroll from 0 to 9. When the desired number appears in the display, press **(pin)**. Then the entered PIN is announced.

## Setting ring time switch

The ring time/toll saver switch allows you to set the number of rings the caller hears before the answering system plays your outgoing message. You can set the switch to answer after two rings or after four rings.

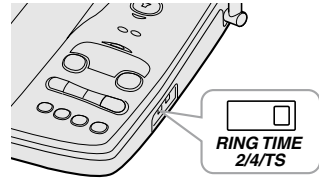

Once the greeting has started, you can stop it when you pick up the call at the handset or base.



If you answer at another phone extension and the greeting has started, you cannot stop the message. Wait until your greeting is complete before starting your conversation.

In the **TS** (Toll Saver) position, the answering system picks up after two rings if you have new messages, and after four rings if there are none. This way, if you call long distance to check your messages, you can hang up after the third ring to avoid billing charges.

## Using your answering system

### NOTE

To stop playing your messages, press **(play/stop)** again.

### Playing your messages

The base LED shows the number of total messages on the display. If the display is blinking, then there are new messages waiting for you. The EXS 2050 is designed to play your new messages first. After you play your new messages, you can then play your old messages.

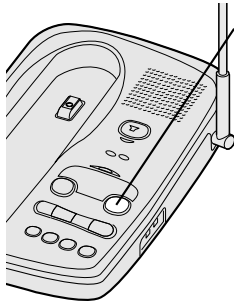

- 1** Press **(play/stop)**. The system announces the number of new and old messages, then the incoming messages are played. The time and day each message was received is announced after the message is played, and the message counter LED displays the number of the current message.
- 2** When all new messages have played, a tone is heard. The message counter LED stops flashing to indicate that all of the new messages have been reviewed.
- 3** After you have reviewed all your messages, you can play your old messages again. Press **(play/stop)** and follow the instructions above.

## NOTE

Pressing **repeat** (◀◀) before 2 seconds (4 seconds from remote) of the message has played causes the system to scan back one message.

## NOTE

If you have several messages, press and hold **repeat** (◀◀) until you return to the message you want to replay.

## NOTE

Each time **skip** (▶▶) is pressed, the system scans forward one message.

## NOTE

If you have several messages, press and hold **skip** (▶▶) to find the message you want to play.

## Repeating a message

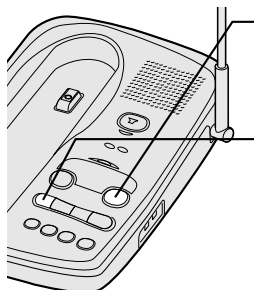

- 1 Press **play/stop** to review your message. The number of stored messages is announced.
- 2 After a message has played for a few seconds, press **repeat** (◀◀) to repeat the message.
- 3 Press **play/stop** at any time to stop reviewing messages and return to standby. The message counter LED shows the total number of messages remaining on the system.

## Skipping a message

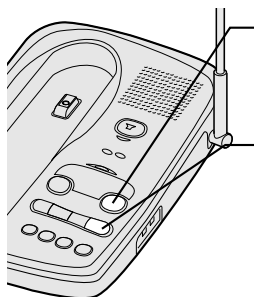

- 1 Press **play/stop** to review your messages. The number of messages is announced.
- 2 Press **skip** (▶▶) at anytime to skip to the next message.
- 3 Press **play/stop** at any time to stop reviewing your messages and return to standby. The message counter LED shows the total number of messages on the system.

## NOTE

When you press **(delete)**, you are permanently deleting the message and the message cannot be replayed.

## NOTE

The voice memo function is completely independent of the outgoing message. It's handy for leaving others a quick message.

## NOTE

A voice memo message will be stored as a typical recorded message.

## NOTE

Position yourself as near to the base as possible and speak clearly.

## Deleting a message

### ▼ Deleting individual messages

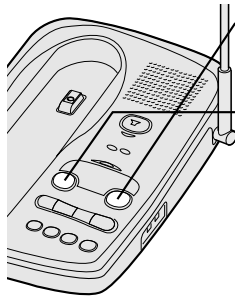

- 1 Press **(play/stop)** to review your message.
- 2 If you decide to delete a message, press **(delete)** anytime during the message. The system beeps and immediately goes to the next message.

### ▼ Deleting all messages

Press and hold **(delete)** while the system is in standby. A tone sounds when all messages are deleted.

If there is a message you have not reviewed, you cannot delete all messages at once.

## Voice memo

The voice memo function allows the user to record a message (up to 10 minutes) on the base.

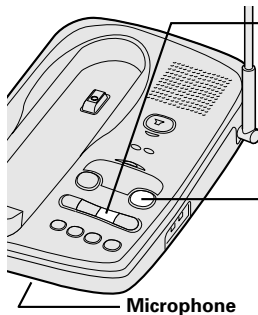

- 1 Press and hold **(voice memo)** until you hear a tone. The message counter LED blinks.
- 2 Speak into the microphone.
- 3 When you have finished, press **(voice memo)** or **(play/stop)** to stop recording. The system returns to standby.
- 4 To play voice memo, press **(play/stop)**.

## NOTE

A recorded conversation is stored and played back with typical recorded messages.

## Recording a conversation

You can record up to 10 minutes of conversation while you are making your call from the handset.

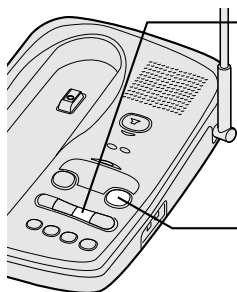

**1** During the conversation from the handset, press and hold **voice memo** on the base. The unit begins recording and the LED blinks. Both parties can hear tones every 15 seconds.

**2** To stop the recording, press **voice memo** or **play/stop**.

## NOTE

You cannot record a conversation while you are speaking on the base.





### NOTE

During the remote operation,  $\tau\text{E}$  displays on the base.



### NOTE

You must enter a command within 15 seconds of entering the command waiting mode or the answering system automatically hangs up and returns to standby.



### NOTE

The system will only play back messages for four minutes and then it returns to the command waiting mode. To continue playing your message, press **# then 2** again within 15 seconds

## Remote access away from home

You can operate your answering system from a remote location using any touch-tone telephone. Use this function to check for recorded messages, to play or delete messages, to record a new outgoing message, and to monitor sounds in the room.

- 1 Call your telephone number.
- 2 While the greeting message plays, press **#** and your PIN code.  
If the answering machine is off, let it ring 10 times until the greeting message plays.  
Then, press **#** and your PIN code.
- 3 The answering system announces the time and day stamp and the number of messages stored in memory. Then the message playback automatically begins.
- 4 You may continue to listen to your message or you may select a command from the following chart.

Command	Function
<b># then 1</b>	Repeat
<b># then 2</b>	Playing your messages
<b># then 3</b>	Skipping a message
<b># then 4</b>	Deleting a message
<b># then 5</b>	Stop message playback
<b># then 6</b>	Answering system on
<b># then 7</b>	Voice memo record/stop (up to 4 minute recording time)
<b># then 8</b>	Greeting message record/stop
<b># then 9</b>	Answer system off
<b># then *</b>	Room monitor

- 5 After all of your messages have played, or the playback time exceeds 4 minutes, you will hear intermittent tones indicating that the system is in the command waiting mode. You may enter another command at this time from the chart above.
- 6 When you finish, hang up to exit the system.  
The answering system automatically returns to standby.



## NOTE

You cannot use # and \* while the new messages are playing. Press # then 5 to stop message playback first and go to step 5.

## Remote room monitor

You can call your answering system from any touch-tone phone to monitor sounds in the room where your base is installed.

- 1** Call your telephone number.
- 2** While the greeting message is played, press # and your PIN code.
- 3** The answering system begins announcing the time and day.
- 4** Press # then 5 to stop the messages.
- 5** Press # then \*. You hear sounds in the room where your phone is installed. After 15 seconds, the answering system returns to the command waiting mode.
- 6** Press # then \* to monitor the room for another 15 seconds. Select another remote function or hang up to exit the system. The answering system automatically returns to standby.

## NOTE

If the handset battery pack is completely discharged or the battery pack is removed, the digital security code will be lost. If this happens, a new security code is set automatically next time the battery pack is charged.

## ADDITIONAL INFORMATION

### Changing the digital security code

The digital security code is an identification code used to connect the handset and the base unit. Normally, setting the code is not necessary.

The first time you charge your handset, the security code is automatically set.

In the rare situation that you suspect another cordless telephone is using the same security code, you can change the code.

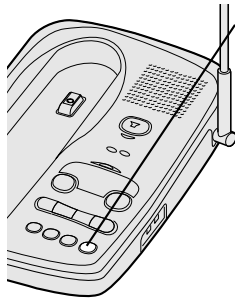

- 1** Remove the handset from the base unit. Press and hold **(page)**.
- 2** While the handset is emitting the paging sound, place the handset on the base unit holding **(page)**. The paging tone stops. Leave the handset on the base for more than 3 seconds. A random, new security code is set.

## NOTE

If you have wall mounted the base, you must remove the beltclip to charge the handset facing forward.

## Installing the beltclip

### To attach the beltclip

Insert the beltclip into the holes on each side of the handset. Press down until it clicks.

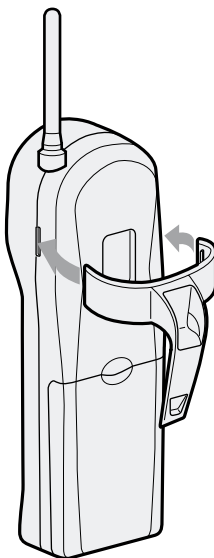

### To remove the beltclip

Pull both sides of the beltclip to release the tabs from the holes.

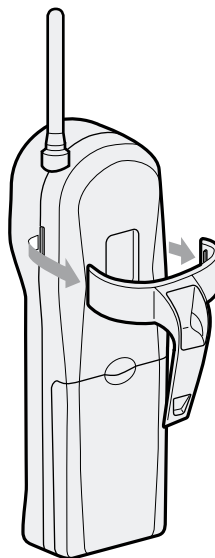

## Headset installation

Your phone may be used with an optional headset, the Uniden HS910. To use this feature, insert the headset plug into the headset jack. Your phone is ready for hands-free conversation.

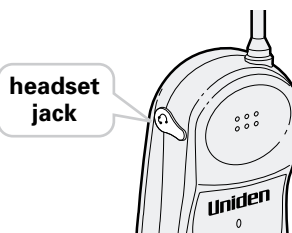

## Note on power sources

### Battery replacement and handling

When the operating time becomes short, even after the battery is recharged, please replace the battery.

With normal usage, your battery should last about one year.

Please contact your place of purchase for a replacement battery.

#### Power Failure

During the period that the power is off, you will not be able to make or receive calls with the telephone.

### RECYCLING NICKEL-CADMIUM BATTERIES



**NICKEL-CADMIUM BATTERIES MUST BE DISPOSED OF PROPERLY.**

Nickel-cadmium cells are used in the battery pack. Please take your used nickel-cadmium battery packs to a store that recycles nickel-cadmium batteries.

#### Caution

- Use the specified battery pack.
- Do not remove the battery from the handset to charge it.
- Never throw the battery into a fire, disassemble it, or heat it.
- Do not remove or damage the battery casing.

## Maintenance

#### When slightly dirty

Wipe with a soft, dry cloth.

#### When very dirty

Wipe with a soft cloth that has been dampened with diluted, neutral detergent. Dry with a dry cloth.

#### When the charging terminals become dirty

Wipe with a dry cloth.

#### Caution

Do not use paint thinner, benzene, alcohol, or other chemical products. Doing so may discolor the surface of the telephone and damage the finish.

## Troubleshooting

If your phone is not performing to your expectations, please try these simple steps first.

Symptom	Suggestion
The <b>status</b> LED won't come on when the handset is placed in the base unit.	<ul style="list-style-type: none"> <li>• Make sure the AC adapter is plugged into the base unit and wall outlet.</li> <li>• Make sure the handset is properly seated in the base unit.</li> <li>• Make sure the charging contacts on the handset and base unit are clean.</li> </ul>
The audio sounds weak and/or scratchy.	<ul style="list-style-type: none"> <li>• Press <b>(channel)</b> to help eliminate background noise.</li> <li>• Make sure that the base unit antenna is in a vertical position.</li> <li>• Move the handset and or base unit to a location away from metal objects or appliances and try again.</li> <li>• Make sure that you are not too far from the base.</li> </ul>
Can't make or receive calls.	<ul style="list-style-type: none"> <li>• Check both ends of the base unit telephone line cord.</li> <li>• Make sure the AC adapter is plugged into the base unit and wall outlet.</li> <li>• Disconnect the AC adapter for a few minutes, then reconnect it.</li> <li>• Make sure <b>(talk)</b> is pressed.</li> </ul>
The handset doesn't ring or receive a page.	<ul style="list-style-type: none"> <li>• The battery pack may be weak. Charge the battery on the base unit for 15-20 hours.</li> <li>• The handset may be too far away from the base unit.</li> <li>• Place the base unit away from appliances or metal objects.</li> <li>• Make sure the ring on/off switch is set to on.</li> </ul>

<b>Symptom</b>	<b>Suggestion</b>
The answering system does not work.	<ul style="list-style-type: none"> <li>• Make sure the base unit is plugged in.</li> <li>• Make sure that the answering system is turned on.</li> </ul>
Messages are incomplete.	<ul style="list-style-type: none"> <li>• The incoming messages may be too long. Remind callers to leave a brief message.</li> <li>• The memory may be full. Delete some or all of the saved messages.</li> </ul>
After a power failure, the outgoing message is deleted.	<ul style="list-style-type: none"> <li>• Record your greeting again. The preset messages should remain.</li> </ul>
No sound on the base unit speaker during call monitoring or message playback.	<ul style="list-style-type: none"> <li>• Adjust the speaker volume on the base unit.</li> </ul>
Cannot access remote call-in features from another touch-tone phone.	<ul style="list-style-type: none"> <li>• Make sure you are using the correct PIN number.</li> <li>• Make sure that the touch-tone phone you're using can transmit the tone for at least two seconds. If it cannot, you may have to use another phone to access your message.</li> </ul>

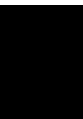

**At Uniden, we'll take care of you!**

If you need any assistance with this product, please call our Customer Hotline at

**1-800-297-1023**

**PLEASE DO NOT RETURN THIS PRODUCT TO THE PLACE OF PURCHASE.**

Our Uniden representatives will be happy to help you with any matters regarding the operation of this unit, available accessories, or any other related matters.

Thank you for purchasing a Uniden product.

Hours: M-F 7:00 AM to 7:00 PM CST.



## Index

### 0 - 9

3-way conferencing.....20

### A

Answering device

Features.....21

Setting up.....22

Using.....26

### B

Base ringer switch.....14

Battery pack

Preparing and  
charging .....10

Replacement and  
handling .....34

### C

Connection.....6

### D

Dialing mode .....7

Digital security code .....3,32

### E, F, G

Earpiece volume.....14

### H

Handset ringer tone  
and volume.....14.

Headset installation .....33

### I, J, K, L

Installing the beltclip.....33

### M, N, O

Maintenance.....34

Making a call .....12

Memory dialing

Erasing a stored  
phone number.....19

Making a call  
with memory dialing.....18

Storing phone  
numbers .....17

Mounting the base unit  
to a wall.....8

Mute .....15

### P, Q

Package contents.....4

### R

Receiving a call .....13

Redialing a call .....15

### S

Setting up your answering  
system

Selecting a PIN code.....24

Selecting the  
message record time .....24

Setting the clock.....22

Setting ring time  
switch.....25

Setting your greeting.....23

Turning the answering  
system on/off.....22

Setup

Base unit.....5

Handset.....10

### T

Troubleshooting.....35

### U, V, W, X, Y, Z

Using your answering system

Deleting a message .....28

Playing your message ....26

Recording a  
conversation .....29

Remote access  
away from home .....30

Remote room monitor...31

Repeating a message.....27

Skipping a message .....27

Voice memo.....28

# THANK YOU

FOR PURCHASING A UNIDEN PHONE!

## Uniden®

Covered under one or more of the following U.S. patents:

4,511,761	4,523,058	4,595,795	4,797,916	5,381,460
5,426,690	5,434,905	5,491,745	5,533,010	5,574,727
5,650,790	5,660,269	5,661,780	5,663,981	5,671,248
5,717,321	5,754,407	5,768,345	5,787,356	5,838,721

© 2000 Uniden America Corporation

All rights reserved • Printed in China UCZZ01670BZ

Manuals.com. All Manuals Search And Download.

## Free Manuals Download Website

<http://myh66.com>

<http://usermanuals.us>

<http://www.somanuals.com>

<http://www.4manuals.cc>

<http://www.manual-lib.com>

<http://www.404manual.com>

<http://www.luxmanual.com>

<http://aubethermostatmanual.com>

Golf course search by state

<http://golfingnear.com>

Email search by domain

<http://emailbydomain.com>

Auto manuals search

<http://auto.somanuals.com>

TV manuals search

<http://tv.somanuals.com>