



E X S 9 9 1 0

OWNER'S MANUAL

Digital Spread
Spectrum Provides
the Longest Range,
the Clearest
Sound, and the
Best Privacy

Uniden®

Introduction

Thank you for choosing the Uniden EXS 9910 cordless telephone. This phone is designed for reliability, long life, and outstanding performance utilizing the latest in 900 MHz Spread Spectrum technology.

Note: Some illustrations in this manual may differ from the actual unit for explanation purposes.

Features

- 900 MHz Digital Spread Spectrum Technology
- 24 Enhanced Memory Dial Location
- 32 Digit Redial
- 2nd Battery Capability
- Backup Power Supply with Optional Battery Pack
- Flash and Pause
- Pulse / Tone Dialing
- Page
- 4 Hour Talk Time
- 7 Day Standby Battery Time
- Handset Earpiece and Ringer Volume Control
- Hearing Aid Compatible
- Lighted Keypad

Digital Spread Spectrum Technology utilizes a “wider frequency band” vs. a “single narrow band” used in standard digital transmissions. The result is a more secure conversation with the clarity of digital sound, extended range, and minimal interference from other cordless phone.

Random Code™ digital security automatically selects one of over 65,000 codes for the handset and base.

These features enhance your phone’s security and also prevent unauthorized calls as a result of your phone being activated by other equipment.

The EXS 9910 features include **AutoTalk™** and **AutoStandby™**. AutoTalk allows you to answer a call by just removing the handset from the base so you don’t have to waste time pushing buttons or flipping switches. AutoStandby allows you hang up by simply returning the handset to the base.

Controls and functions

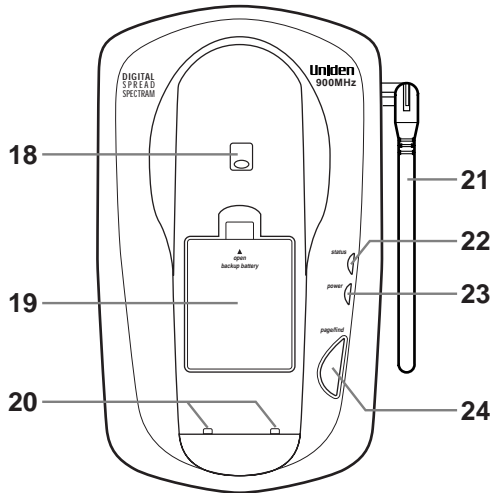
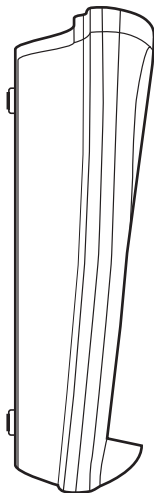
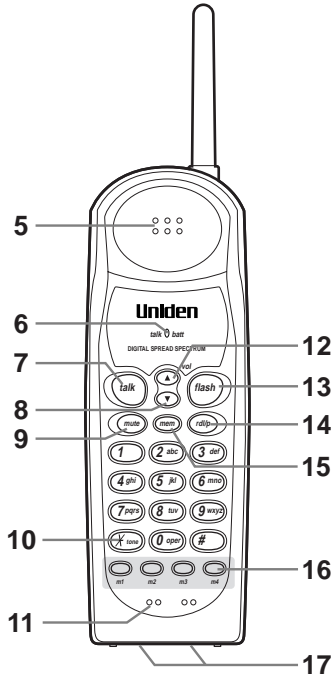
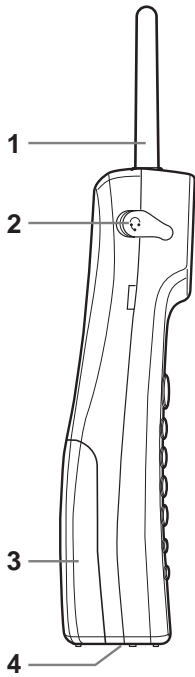

1. Handset antenna
2. Headset jack cover
3. Handset battery compartment
4. Handset ring switch
5. Handset speaker
6. Talk/Batt LED
7. Talk key
8. Volume down key
9. Mute key
10. Tone key
11. Handset microphone
12. Volume up key
13. Flash key
14. Redial/Pause key
15. Memory key
16. One-touch memory keys
17. Handset battery charging contacts
18. Handset retainer clip
19. Spare battery charge compartment
20. Base charging contacts
21. Base antenna
22. Status LED
23. Power LED
24. Page/Find key
25. Pulse-Tone switch
26. DC power input
27. Phone jack

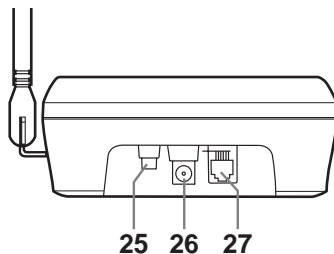
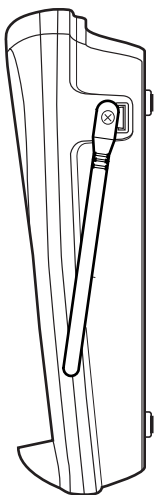

CONTENTS

OF YOUR OWNER'S MANUAL

Contents

Introduction / Features.....inside front cover
Controls and Functionsinside front cover

Getting Started

Read this first.....3
Step 1: Checking the package contents4
Step 2: Setting up the base unit5
 Mounting the base unit on a wall8
Step 3: Installing the handset battery pack.....10
 Charging optional battery packs11
 Automatic digital code security12

Basics

Making a call13
Receiving a call14
Flash and Call Waiting15
Adjusting the ringer and earpiece volume15
Redialing a call16
Mute16
Using page feature17

Memory Dialing

Storing phone numbers18
Making calls with memory dialing.....19
Erasing a stored phone number.....20

Additional Information

Installing the beltclip.....21
Headset installation21
Note on power sources22
Maintenance.....22

Troubleshooting23

Specifications24

Index25

Getting Started

Basics

Memory Dialing

Additional
Information

Read this first

This cordless telephone must be set up before use. Follow these steps;

Step 1 (page 4)

Unpack and check the telephone and accessories.

Step 2 (page 5 to 9)

Next, choose the best location to set up the base unit.



Base unit

Step 3 (page 10 to12)

Then, insert the battery pack into the handset. You must charge the battery pack for more than 16 hours before using the phone.



Handset

About the digital security code

This cordless telephone uses a digital security code to prevent unauthorized access to your base unit. This security code prevents other cordless handsets from making calls through your base unit. A random security code will be assigned automatically between your base unit and handset when you charge the battery pack for the first time.

Checking the package contents

Make sure you have received the following items in the package. If any of these items are missing or damaged, contact the **Uniden Parts Department** (see below).



• **Base unit**



• **Handset**

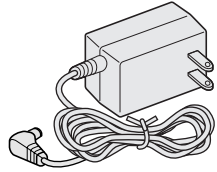

• **AC adapter (AD-420)**

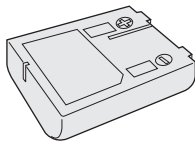

• **Rechargeable battery pack (BT-999)**

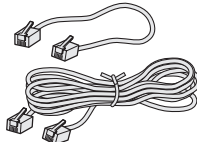

• **Telephone line cord (2)**

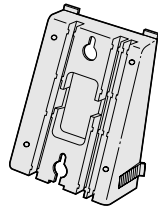

• **Wall mount adapter**

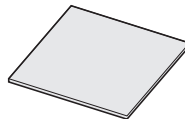

• **Memo sticker (2)**

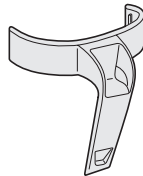

• **Beltclip**

- **This Owner's Manual**
- **Precautions and Important Safety Instructions**
- **Registration Card**
- **Quick Reference Guide**

Uniden Parts Department

(800) 554-3988

Hours: M-F 8:00 AM to 5:00 PM CST.

We can also be reached on the web at www.uniden.com.

Setting up the base unit

Do the following steps.

- Choose the best location
- Connect the base unit
- Choose the dialing mode

Choose the best location

Before choosing a location for your new phone, read the INSTALLATION CONSIDERATIONS included in the PRECAUTIONS AND IMPORTANT SAFETY INSTRUCTIONS brochure. Here are some important guidelines you should consider:

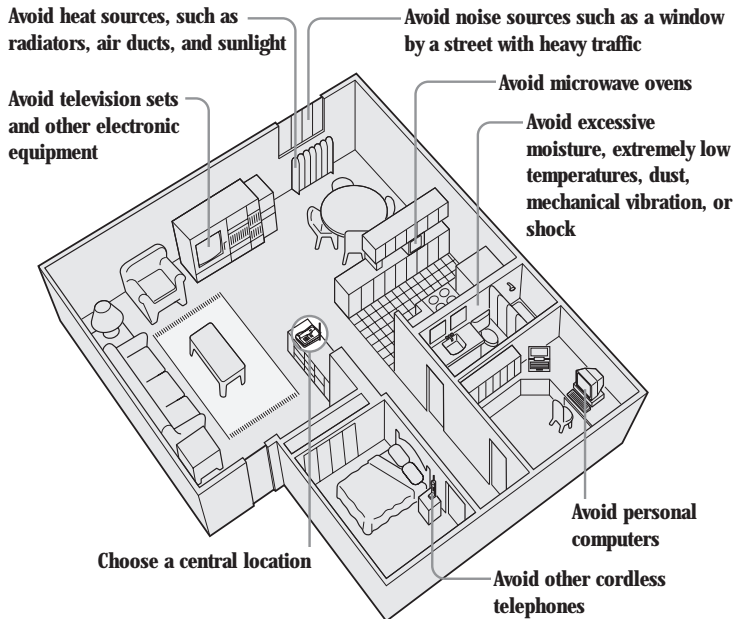

- You should charge your handset for more than 16 hours before using the phone.
- The location should be close to both a phone jack and continuous power outlet which is not switchable.
- Keep the base and handset away from sources of electrical noise such as motors and fluorescent lighting.
- Be sure there is sufficient space to raise the base antenna fully vertical.
- The base can be placed on a desk, tabletop or mounted on a standard wall plate.

Connect the base unit

If you want to install the base unit on the wall, see page 8.

NOTE

Place the power cord so it does not create a trip hazard, or where it could become chafed and create a fire or electrical hazard.

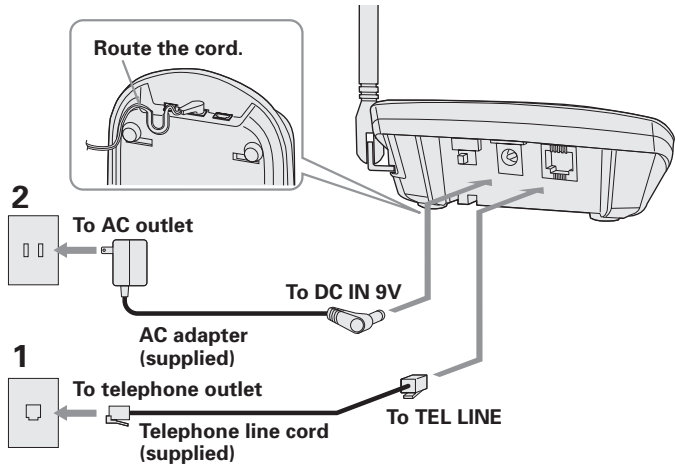

- 1 Connect the telephone line cord to the **TEL LINE** jack and to a telephone outlet.
- 2 Connect the AC adapter to the **DC IN 9V** jack and to a standard 120V AC wall outlet.
- 3 Set the base unit on a desk or tabletop and place the handset on the base unit. Then raise the antenna to a vertical position.

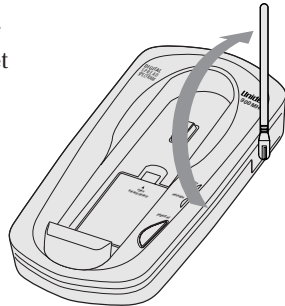



Use only the supplied AD-420 AC adapter. Do not use any other AC adapter.

Polarity of the plug

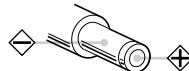

Connect the AC adapter to a continuous power supply.



Place the base unit close to the AC outlet so that you can unplug the AC adapter easily.



If your telephone outlet isn't modular, contact your telephone company for assistance.

Modular



Choose the dialing mode

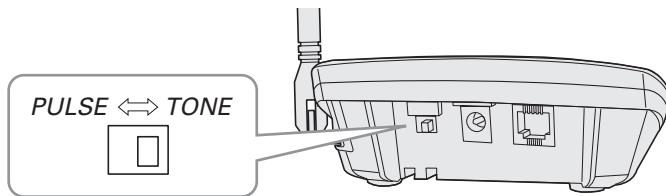

Depending on your dialing system, set the **PULSE-TONE** switch as follows:

If your dialing system is	Set the switch to
Tone	<i>TONE</i>
Pulse	<i>PULSE</i>

If you aren't sure of your dialing system

Make a trial call with the **PULSE-TONE** switch set to **TONE**. If the call connects, leave the switch as is; otherwise, set to **PULSE**.

Mounting the base unit on a wall

Standard wall plate mounting

This phone can be mounted on any standard telephone wall plate.

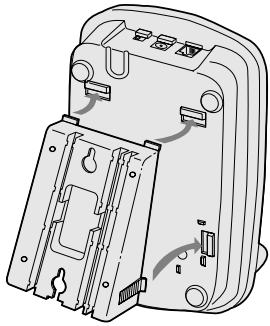
- 

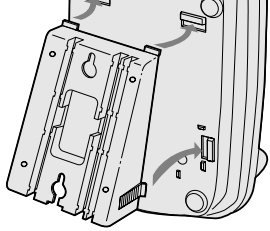
1 Snap the wall mount adapter into the notches on the base.
- 

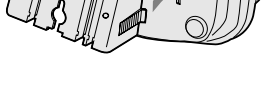
2 Plug the telephone line cord to the **TEL LINE** jack and the AC adapter to the **DC IN 9V** jack.
- 

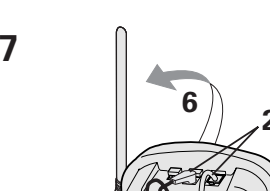
3 Plug the telephone line cord into the telephone outlet.
- 

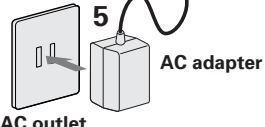
4 Wrap the AC adapter cord inside the molded wiring channel. Then wrap the cord around the strain relief notch.
- 

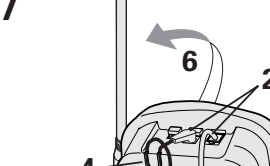
5 Plug the AC adapter into a standard 120V AC wall outlet.
- 

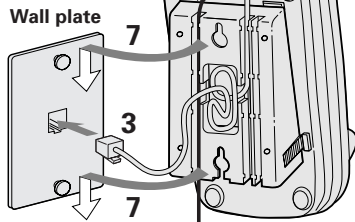
6 Raise the antenna to a vertical position.
- 

7 Align the mounting slots on the base, with the mounting posts on the wall. Push in and down until the phone is firmly seated.



If the handset beltclip is attached, you cannot charge the handset facing forward when the phone is mounted on the wall (See page 21).

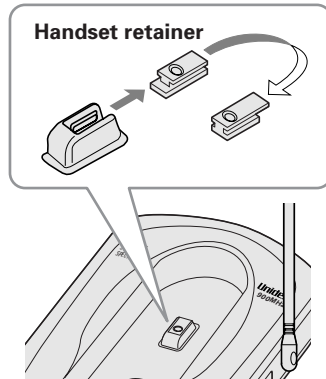

8 On the base unit, pull the handset retainer out of the slot. Rotate it clockwise 180 degrees.

9 Flip the retainer from front to back. Slide it back into the slot so that the lip of the retainer is up and the oval is down. The retainer holds the handset in place.

Direct wall plate mounting

If you don't have a standard wall plate, you can mount your phone directly to the wall. Before doing this, consider the following:

- Avoid electrical cables, pipes, or other items behind the mounting location, that could cause a hazard when inserting screws into the wall.
- Try to mount your phone within 10 - 15 feet of a working phone jack to avoid excessive cord lengths.
- Make sure the wall material is capable of supporting the weight of the base and handset.

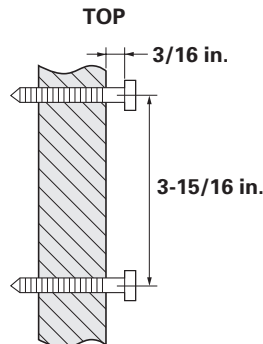

1 Insert two mounting screws into the wall, (with their appropriate anchoring device), 3-15/16 inches apart. Allow about 3/16 of an inch between the wall and screwheads for mounting the phone.

2 Refer to steps 1 through 9 on page 8 - 9 to mount the telephone.

Installing the handset battery pack

Charge the battery pack for more than 16 hours before you start using your phone.

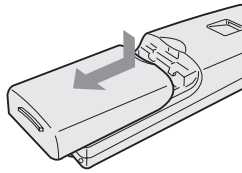

- 1** Press in on the battery cover release and slide the cover down until it comes off.

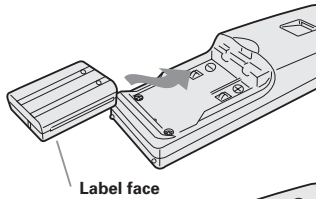

- 2** Install the nickel-cadmium battery with the label facing down.

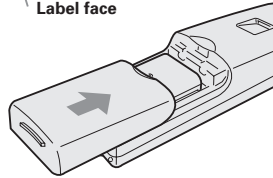

- 3** Slide the battery cover on until it snaps into place.

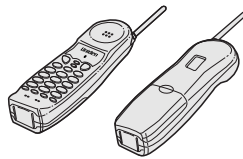

- 4** Place the handset on the base.

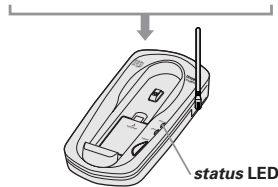

- 5** Make sure that the "*status*" LED lights. If the LED doesn't light, check to see that the AC adapter is plugged in and that the handset makes good contact with the base charging contacts.



Use only Uniden Battery (BT-999) supplied with your phone.

NOTE

Even when the battery pack is not being used, it will gradually discharge over a long period. For optimum performance, be sure to return the handset to the base unit after a telephone call for charging the battery.

NOTE

Rechargeable batteries have a memory effect that reduces standby and talk time. To avoid this memory effect, on a monthly basis, use the phone until the **talk/batt** LED blinks. Then charge the battery for 16 hours.

NOTE

Please visit your authorized Uniden dealer to obtain an extra battery pack or contact the Uniden parts department at (800)554-3988. Hours are from 8:00 a.m. to 5:00 p.m. Central Time, Monday through Friday.

NOTE

In the event of a power failure, your spare battery pack can be used as a back-up power supply for the base unit.

Battery use time (per charge)

From fully charged

- Four hours continuous use.
- Seven days when the handset is in the standby mode.

When the battery charge becomes low

When the voltage of battery pack in the handset is very low and needs to be charged, the phone is programmed to eliminate functions in order to save power. If the battery charge becomes **talk/batt** LED blinks. If the phone is in use, the handset beeps. Complete your conversation as quickly as possible and return the handset to the base unit for charging.

Cleaning the battery contacts

To maintain a good charge, it is important to clean the battery contacts on the handset and base unit about once a month. Use a pencil eraser or other contact cleaner.

Do not use any liquids or solvents.

Charging optional battery packs

The base unit of your phone is equipped with a compartment for charging an extra battery pack for use in your handset. **You can obtain an extra battery pack from your authorized Uniden dealer.**

1. Pull the cover of battery charger.
2. Put the battery pack in the compartment with contacts facing down.
3. Charge the battery for 21 hours.

To install the charged battery into the handset, refer to "Installing the handset battery pack", page 10.

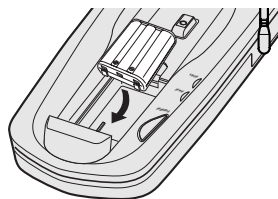

Automatic digital code security

To prevent other parties from making unauthorized calls on your phone line, a digital code was added to the EXS 9910. Your phone's handset and base share this code, which is randomly set each time you place the handset on the base.

Making a call

NOTE

If the **talk/batt** LED never stops flashing, place the handset on the base for at least five seconds and make a call again.

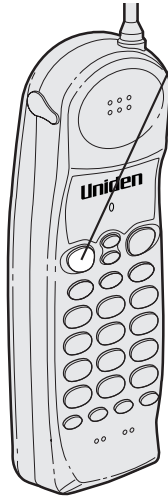

- 1 Press **(talk)**. The **talk/batt** LED lights.
- 2 Dial the phone number.
- 3 To hang up, press **(talk)** or return the handset to the base.

Other Operations

To	Do this
To adjust the ear speaker volume	Press (▲) or (▼) during the call.
To temporarily switch to tone dial (When the base is set to pulse mode)	Press (*/tone) . The following numbers dialed will be sent as tone dialing.

NOTE

When you receive a call during a page or memory storing, pressing only the **(talk)** key connects a call.

Receiving a call

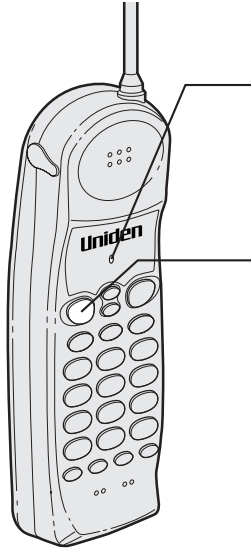

Handset on the base

- 1** Phone rings. The **talk/batt** LED flashes.
- 2** Pick up the handset and begin speaking.
- 3** To hang up, press **(talk)** or return the handset to the base.

Handset off the base

- 1** Phone rings. The **talk/batt** LED flashes.
- 2** Press **(talk)** or any key and begin speaking.
- 3** To hang up, press **(talk)** or return the handset to the base.

Flash and Call Waiting

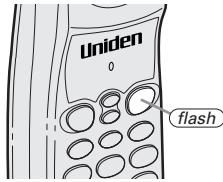

If you have “Call Waiting” service and a call waiting tone sounds while you are on a call, press **flash** to accept the waiting call. There is a short pause, then you will hear the new caller. To return to the original caller, press **flash** again.

Adjusting the ringer and earpiece volume

Ringer tone

The phone has four types of ringer tone. In standby mode, press **flash** and **1** - **4** on the keypad.

Ringer volume

In standby mode, press **▲** for high and **▼** for low.

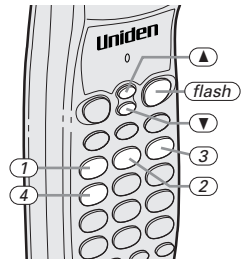

To turn the ringer off, set the **ringer on/off** switch to **off**.

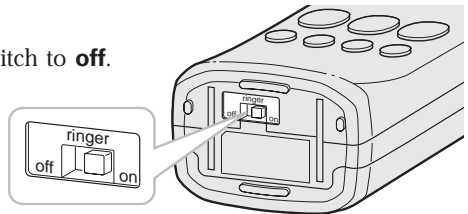

Handset earpiece volume

The phone has four earpiece volume levels, Normal, Medium, High, and Loud. Pressing **▲** or **▼** during a telephone call will change the earpiece volume of the handset. This setting will remain in effect after the telephone call has ended.

When you press **▲** in Loud mode or press **▼** in Normal mode, error sound beeps.

NOTE

If the recently dialed number exceeds 32 digits, only the first 32 digits are retained for redialing.

Redialing a call

The last phone number dialed can be quickly redialed.



- 1 Press **(talk)**. The **talk/batt** LED lights.
- 2 Press **(rdl/p)**.
- 3 Press **(talk)** or place the handset on the base to hang up.

Mute

You can turn off the handset microphone so that the person you are talking with cannot hear you.



- 1 Press **(mute)** during a telephone call. The **talk/batt** LED blinks. The other party will not be able to hear you although you can hear them.
- 2 To cancel mute, press **(mute)** again.

Using page feature

NOTE

If the handset was paged during a call, you can cancel it by pressing **talk**.

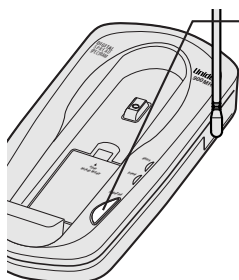

To locate the handset (while it's off the base), press **page/find** on the base. The handset beeps for 15 seconds.

Storing phone numbers

Your EXS 9910 stores up to 24 numbers in the handset.

NOTE

You must press a key within 30 seconds or the phone will return to standby. If you return the handset in the cradle, the phone will return to standby too.



- 1 Press **mem** while in standby mode. The **talk/batt** LED flashes.
- 2 Dial the number you wish to store (up to 16 digits).
- 3 Press **mem** again.
- 4 Enter a two-digit number (01 - 20) or press one of the One-touch memory keys (**m1** - **m4**) to select the memory location where you wish to store the number.
- 5 The **talk/batt** LED goes out. A confirmation beep indicates the number has been stored.

NOTE

Use the supplied memo sticker to write stored numbers.

MEMORY
DIALING

Making calls with memory dialing

Memory dialing



- 1 Press **(talk)**. The **talk/batt** LED lights.
- 2 Press **(mem)**.
- 3 Enter a two-digit number (01 - 20) to select the memory location you wish to dial.
- 4 To hang up, press **(talk)** or return the handset to the base.

One-touch memory dialing

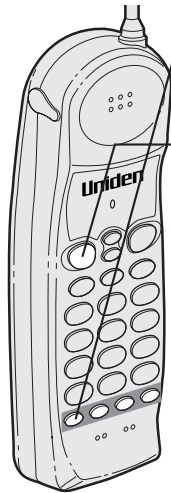

- 1 Press one of the One-touch memory keys (**(m1)** - **(m4)**) you wish to dial.
- 2 To hang up, press **(talk)** or return the handset to the base.

Erasing a stored phone number



- 1** Press **mem** in the standby mode. The **talk/batt** LED flashes.
- 2** Press **mem** again.
- 3** Enter the memory location number (01 - 20 or **m1** - **m4**) you wish to delete. A confirmation beep indicates the number has been erased.

NOTE

If you have wall mounted the base, you must remove the beltclip to charge the handset facing forward.

Installing the beltclip

To attach the beltclip

Insert the beltclip into the holes on each side of the handset. Press down until it clicks.

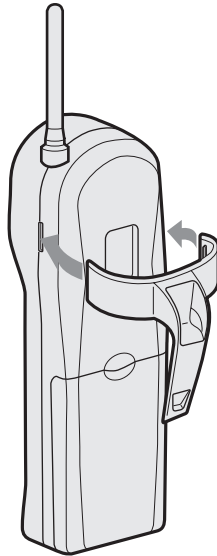

To remove the beltclip

Pull both sides of the beltclip to release the tabs from the holes.

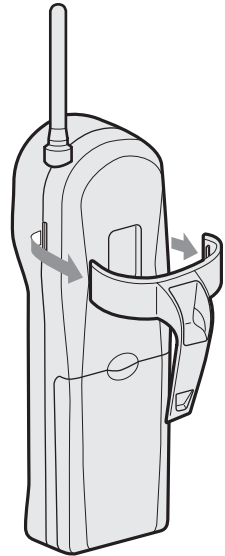

Headset installation

Your phone may be used with an optional headset. To use this feature, simply plug any standard 2.5mm headset plug into the headset jack. Your phone is ready for hands-free conversation.

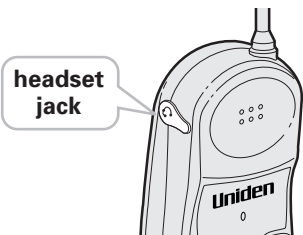

Note on power sources

Battery replacement and handling

When the operating time becomes short, even after a battery is recharged, please replace the battery.

With normal usage, your battery should last about one year.

Please contact your place of purchase for a replacement battery.

Power Failure

During the period that the power is off, you will not be able to make or receive calls with the telephone.

RECYCLING NICKEL-CADMIUM BATTERIES

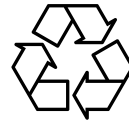

Ni-Cd

NICKEL-CADMIUM BATTERIES MUST BE DISPOSED OF PROPERLY.

Nickel-cadmium cells are used in the battery pack. Please take your used nickel-cadmium battery packs to a store that recycles nickel-cadmium batteries.

Caution

- Use the specified battery pack.
- Do not remove the battery from the handset to charge it.
- Never throw the battery into a fire, disassemble it, or heat it.
- Do not remove or damage the battery casing.

Maintenance

When slightly dirty

Wipe with a soft, dry cloth.

When very dirty

Wipe with a soft cloth that has been dampened with diluted, neutral detergent. Dry with a dry cloth.

When the charging terminals become dirty

Wipe with a pencil eraser or other contact cleaner.

Caution

Do not use paint thinner, benzene, alcohol, or other chemical products. Doing so may discolor the surface of the telephone and damage the finish.

Troubleshooting

If your phone is not performing to your expectations, please try these simple steps first.

Symptom	Suggestion
The status LED won't come on when the handset is placed in the base unit.	<ul style="list-style-type: none"> • Make sure the AC adapter is plugged into the base unit and wall outlet. • Make sure the handset is properly seated in the base unit. • Make sure the charging contacts on the handset and base unit are clean.
The audio sounds weak and/or scratchy.	<ul style="list-style-type: none"> • Make sure that the base unit antenna is in a vertical position. • Move the handset and or base unit to a different location away from metal objects or appliances and try again. • Make sure that you are not too far from the base.
Can't make or receive calls.	<ul style="list-style-type: none"> • Check both ends of the base unit telephone line cord. • Make sure the AC adapter is plugged into the base unit and wall outlet. • Disconnect the AC adapter for a few minutes, then reconnect it. • Make sure (talk) is pressed.
The handset doesn't ring or receive a page.	<ul style="list-style-type: none"> • The battery pack may be weak. Charge the battery on the base unit for more than 16 hours. • The handset may be too far away from the base unit. • Place the base unit away from appliances or metal objects. • Make sure Ringer switch is ON.

Specifications

General

The EXS 9910 complies with FCC Parts 15 and 68.
 Frequency control: PLL
 Modulation: Frequency shift keying
 Operating temperature: 0°C to +50°C (+32°F to +122°F)

Base unit

Frequency: 904.2 MHz to 925.8 MHz (20 channel)
 Power requirements: 9V 350mA (from AC adapter)
 Size: 5-5/32 in. (W) x 2-1/2 in. (D) x 8-57/64 in. (H)
 (131 mm (W) x 63.6 mm (D) x 226 mm (H))
 Weight: Approx. 15.7 oz. (Approx. 445 g)

Handset

Frequency: 904.2 MHz to 925.8 MHz (20 channel)
 Power requirements: Rechargeable Nickel-Cadmium battery pack
 Size (without antenna): 2-17/64 in. (W) x 2-1/32 in. (D) x 7-1/64 in. (H)
 (57.6 mm (W) x 51.7 mm (D) x 178 mm (H))
 Weight: Approx. 9.4 oz. (267 g) (including battery)
 Battery: BT-999
 Capacity: 600 mA AH, 3.6V
 Talk mode: 4 hours TYP
 Standby mode: 7 days TYP

Specifications, features, and availability of optional accessories are all subject to change without prior notice.

At Uniden, we'll take care of you!

If you need any assistance with this product, please call our Customer Hotline at

1-800-297-1023

PLEASE DO NOT RETURN THIS PRODUCT TO THE PLACE OF PURCHASE.

Our Uniden representatives will be happy to help you with any matters regarding the operation of this unit, available accessories, or any other related matters.

Thank you for purchasing a Uniden product.
 Hours: M-F 7:00 AM to 7:00 PM CST.

Index

A, B

Battery pack	
Preparing and charging	10
Replacement and handling	22
Beltclip installation	21

C

Connection	6
------------------	---

D

Dialing mode	7
Digital security code	3, 12

E, F, G

Earpiece volume	15
-----------------------	----

H, I, J, K, L

Handset ringer tone	15
Headset installation	21

M, N, O

Maintenance	22
Making a call	13
Memory dialing	
Making calls	
with memory dialing	19
Erasing a stored phone number	20
Storing phone numbers	18

Mounting the base unit	
to a wall	8
Mute	16

P, Q

Package contents	4
Page feature	17

R

Receiving a call	14
Redialing a call	16

S

Setup	
Base unit	5
Handset	10
Specifications	24

T, U, V, W, X, Y, Z

Troubleshooting	23
-----------------------	----

THANK YOU

FOR PURCHASING A UNIDEN PHONE!

Uniden®

Covered under one or more of the following U.S. patents:

4,511,761 4,523,058 4,595,795 4,797,916 5,381,460
5,426,690 5,434,905 5,491,745 5,533,010 5,574,727
5,650,790 5,660,269 5,661,780 5,663,981 5,671,248
5,717,312 5,754,407 5,768,345 5,787,356 5,838,721

© July 1999 Uniden America Corporation

All rights reserved • Printed in China UCZ01645BZ

Free Manuals Download Website

<http://myh66.com>

<http://usermanuals.us>

<http://www.somanuals.com>

<http://www.4manuals.cc>

<http://www.manual-lib.com>

<http://www.404manual.com>

<http://www.luxmanual.com>

<http://aubethermostatmanual.com>

Golf course search by state

<http://golfingnear.com>

Email search by domain

<http://emailbydomain.com>

Auto manuals search

<http://auto.somanuals.com>

TV manuals search

<http://tv.somanuals.com>