



E X S 9 9 6 0

OWNER'S MANUAL

900 MHz Digital
Spread Spectrum
Technology

Caller ID

Call Waiting
Caller ID

Uniden®

Introduction

Congratulations on your purchase of the EXS 9960 cordless telephone. This phone is designed for reliability, long life, and outstanding performance utilizing the latest in 900 MHz Spread Spectrum technology.

Note: Some illustrations in this manual may differ from the actual unit for explanation purposes.

Features

- 900 MHz Spread Spectrum Technology
- Caller ID and Call Waiting Caller ID
- 50 Number Caller ID Memory
- Lighted Keypad
- 3-Line, 16 Character Backlit Handset Display
- 20 Enhanced Memory dial Locations
- 32 Digit Redial
- 2nd Battery Capability
- Back-up Power Supply with Optional Battery Pack
- 3 Redial memories
- Flash
- Pause
- Pulse / Tone Dialing
- Page / Find
- 7 Day Standby Battery Life
- 4 Hour Talk Time
- Handset Earpiece and Ringer Volume Control
- Hearing Aid Compatible

Digital Spread Spectrum Technology utilizes a “wider frequency band” vs. a “single narrow band” used in standard digital transmissions. The result is a more secure conversation with the clarity of digital sound, extended range, and minimal interference from other cordless phone.

Random Code™ digital security automatically selects one of over 65,000 codes for the handset and base.

These features enhance your phone’s security and also prevent unauthorized calls as a result of your phone being activated by other equipment.

Controls and functions

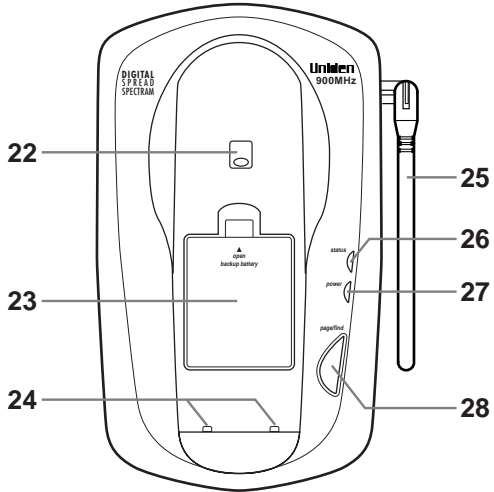
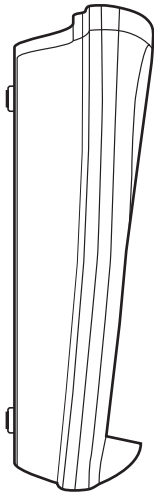
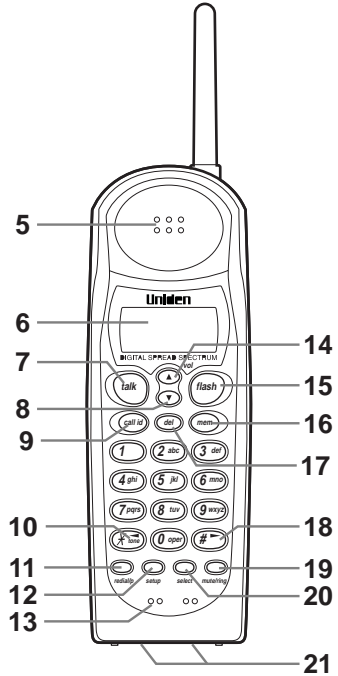
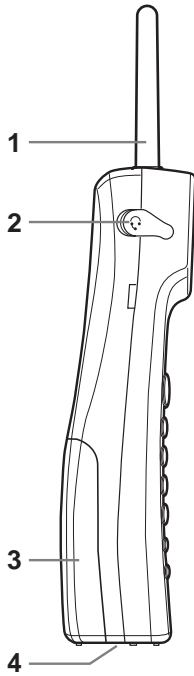

1. Handset antenna
2. Headset jack cover
3. Handset battery compartment
4. Ringer off-on switch
5. Handset earpiece
6. LCD display
7. Talk key
8. Volume/Cursor down key
9. Call ID key
10. Tone/Backspace key
11. Redial/Pause key
12. Setup key
13. Handset microphone
14. Volume/Cursor up key
15. Flash key
16. Memory key
17. Delete key
18. Cursor forward key
19. Mute/Ring key
20. Select key
21. Handset charging contacts
22. Handset retainer clip
23. Spare battery charge compartment
24. Base charging contacts
25. Base antenna
26. Status LED
27. Power LED
28. Page/Find key
29. Pulse-Tone switch
30. DC power input
31. Phone jack

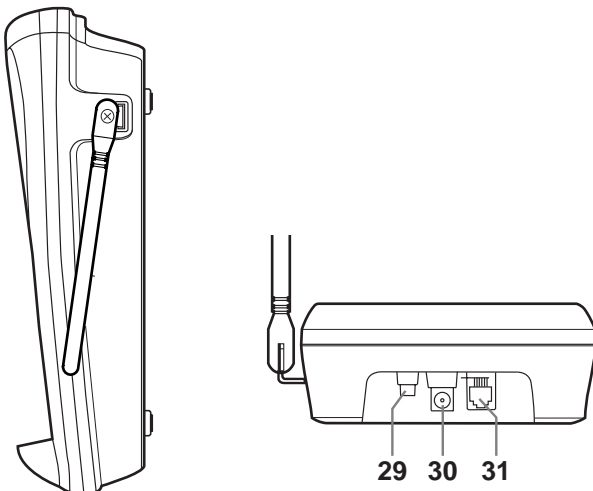

CONTENTS

OF YOUR OWNER'S MANUAL

Contents

Introduction / Features.....	inside front cover
Controls and Functions	inside front cover
Getting Started	
Read this first.....	3
Step 1: Checking the package contents.....	4
Step 2: Setting up the base unit	5
Mounting the base unit on a wall	8
Step 3: Preparing the battery pack.....	10
Basics	
Making a call	12
Receiving a call	14
Adjusting the ringer and earpiece volume	15
Redialing a call	16
Telephone features	
Memory dialing	
Storing phone numbers and names.....	18
Making calls with memory dialing	20
Editing a stored name and/or phone number.....	22
Erasing a stored name and phone number.....	24
Paging	25
Mute	26
Caller ID features	
Caller ID.....	27
When the telephone rings	28
Viewing the Caller ID Message list.....	29
Deleting information from the Caller ID list	30
Using the Caller ID list	32
Using "Caller ID on call waiting" service	34
Additional Information	
Changing the digital security code.....	35
Installing the beltclip.....	36
Headset installation.....	36
Note on power sources	37
Maintenance.....	37
Troubleshooting	38
Specifications	39
Index	40

Getting Started

Basics

Telephone
Features

Caller ID
Features

Additional
Information

Read this first

This cordless telephone must be set up before use. Follow these steps;

Step 1 (page 4)

Unpack and check the telephone and accessories.

Step 2 (page 5 to 9)

Next, choose the best location to set up the base unit.



Base unit

Step 3 (page 10 to 11)

Then, insert the battery pack into the handset. You must charge the battery pack for more than 17 hours before using the phone.



Handset

About the digital security code

This cordless telephone uses a digital security code to prevent unauthorized access to your base unit. This security code prevents other cordless handsets from making calls through your base unit. A random security code will be assigned automatically between your base unit and handset when you charge the battery pack for the first time.

If you want to reset the security code, see page 35.

Checking the package contents

Make sure you have received the following items in the package.



• Base unit



• Handset

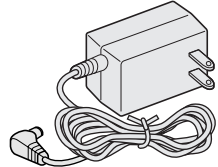

• AC adapter (AD-420)

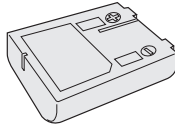

• Rechargeable battery pack (BT-999)

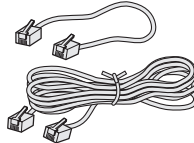

• Telephone line cord (2)

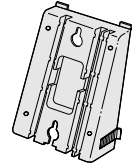

• Wall mount adapter

- This Owner's Manual
- Precautions and Important Safety Instructions
- Quick Reference Guide
- Registration Card

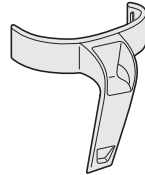

• Beltclip

Uniden Parts Department

(800) 554-3988

Hours: M-F 8:30 AM to 5:00 PM CST.

We can also be reached on the web at www.uniden.com.

Setting up the base unit

Do the following steps.

- Choose the best location
- Connect the base unit
- Choose the dialing mode

Choose the best location

Before choosing a location for your new phone, read the INSTALLATION CONSIDERATIONS included in the PRECAUTIONS AND IMPORTANT SAFETY INSTRUCTIONS brochure. Here are some important guidelines you should consider:

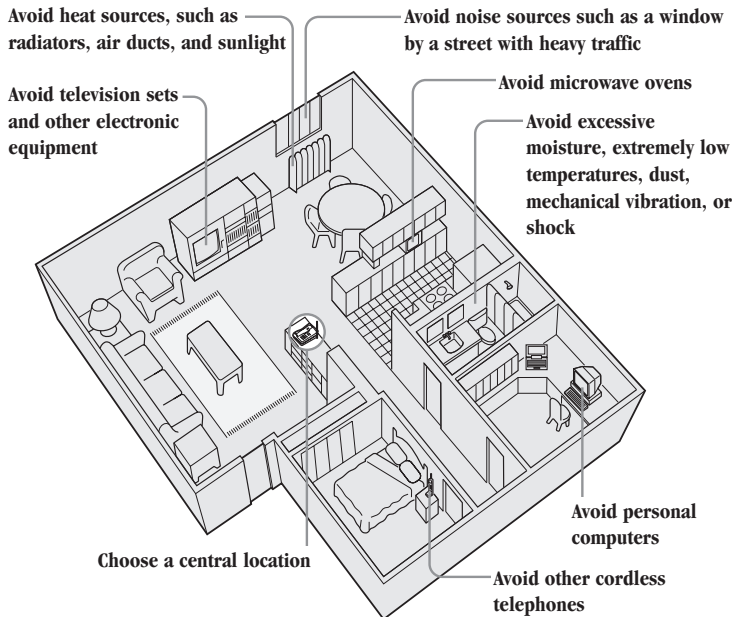

- You should charge your handset for more than 17 hours before using the phone.
- The location should be close to both a phone jack and a continuous power outlet which is not switchable.
- Keep the base and handset away from sources of electrical noise such as motors and fluorescent lighting.
- Be sure there is sufficient space to raise the base antenna fully vertical.
- The base can be placed on a desk, tabletop or mounted on a standard wall plate.

Connect the base unit

If you want to install the base unit on the wall, see page 8.

NOTE

Place the power cord so it does not create a trip hazard, or where it could become chafed and create a fire or electrical hazard.

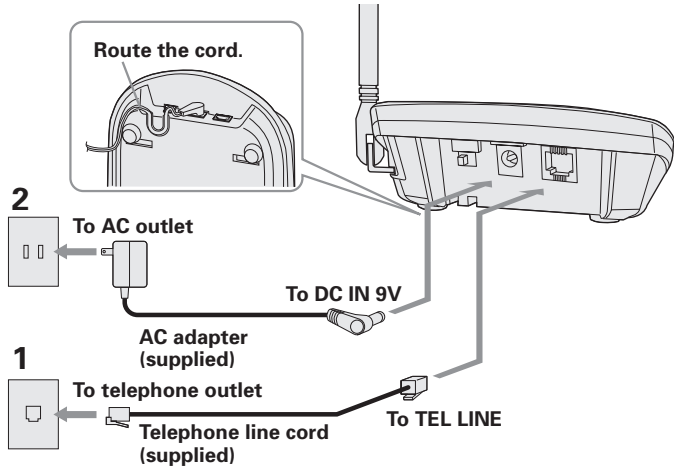

- 1 Connect the telephone line cord to the **TEL LINE** jack and to a telephone outlet.
- 2 Connect the AC adapter to the **DC IN 9V** jack and to a standard 120V AC wall outlet.
- 3 Set the base unit on a desk or tabletop and place the handset on the base unit. Then raise the antenna to a vertical position.

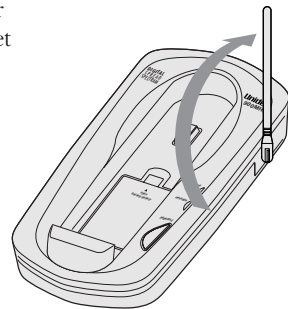



Use only the supplied AD-420 AC adapter. Do not use any other AC adapter.

Polarity of the plug

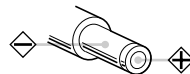

Connect the AC adapter to a continuous power supply.



Place the base unit close to the AC outlet so that you can unplug the AC adapter easily.



If your telephone outlet isn't modular, contact your telephone company for assistance.

Modular



Choose the dialing mode

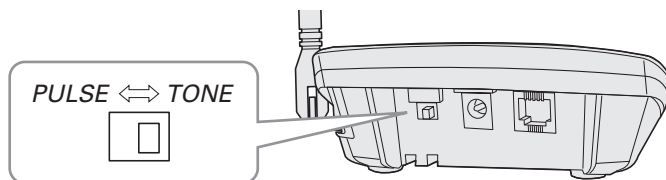

Depending on your dialing system, set the **PULSE-TONE** switch as follows:

If your dialing system is	Set the switch to
Tone	<i>TONE</i>
Pulse	<i>PULSE</i>

If you aren't sure of your dialing system

Make a trial call with the **PULSE-TONE** switch set to ***TONE***. If the call connects, leave the switch as is; otherwise, set to ***PULSE***.

Mounting the base unit on a wall

Standard wall plate mounting

This phone can be mounted on any standard telephone wall plate.

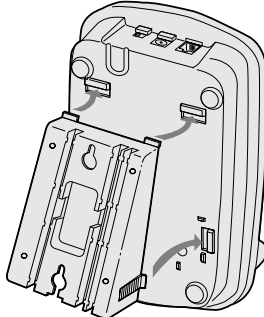
- 

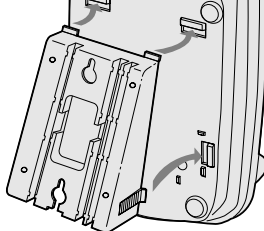
1 Snap the wall mount adapter into the notches on the base.
- 

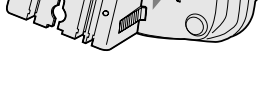
2 Plug the telephone line cord to the **TEL LINE** jack and the AC adapter to the **DC IN 9V** jack.
- 

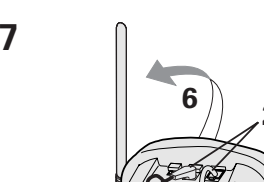
3 Plug the telephone line cord into the telephone outlet.
- 

4 Wrap the AC adapter cord inside the molded wiring channel. Then wrap the cord around the strain relief notch.
- 

5 Plug the AC adapter into a standard 120V AC wall outlet.
- 

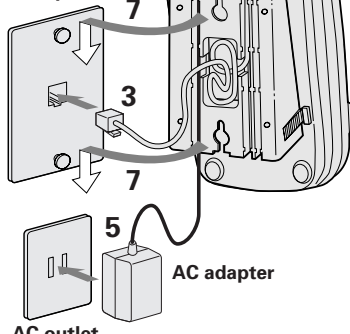
6 Raise the antenna to a vertical position.
- 

7 Align the mounting slots on the base, with the mounting posts on the wall. Push in and down until the phone is firmly seated.



If the handset beltclip is attached, you cannot charge the handset facing forward when the phone is mounted on the wall. (See page 36.)

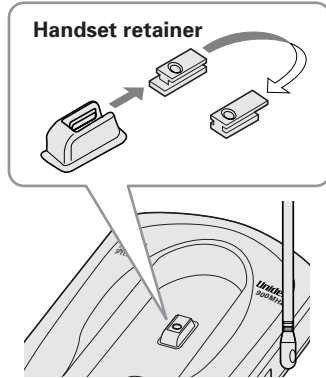

- 8** On the base unit, pull the handset retainer out of the slot. Rotate it clockwise 180 degrees.
- 9** Flip the retainer from front to back. Slide it back into the slot so that the lip of the retainer is up and the oval is down. The retainer holds the handset in place.

Direct wall plate mounting

If you don't have a standard wall plate, you can mount your phone directly to the wall. Before doing this, consider the following:

- Avoid electrical cables, pipes, or other items behind the mounting location, that could cause a hazard when inserting screws into the wall.
- Try to mount your phone within 10 - 15 feet of a working phone jack to avoid excessive cord lengths.
- Make sure the wall material is capable of supporting the weight of the base and handset.
- Use #10 screws with anchoring devices suitable for the wall material where the base unit will be placed.

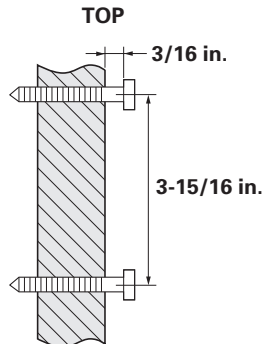

- 1** Insert two mounting screws into the wall, (with their appropriate anchoring device), 3-15/16 inches apart. Allow about 3/16 of an inch between the wall and screwheads for mounting the phone.
- 2** Refer to steps 1 through 9 on page 8 and 9 to mount the telephone.

Preparing the battery pack

Charge the battery pack for more than 17 hours before you start using your phone.

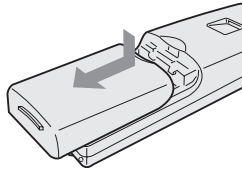

- 1** Press in on the battery cover release and slide the cover down until it comes off.

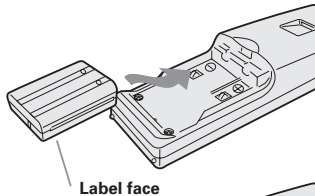

- 2** Install the nickel-cadmium battery with the label facing down.

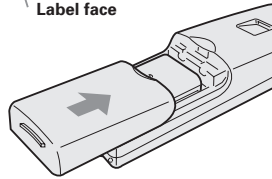

- 3** Slide the battery cover on until it snaps into place.

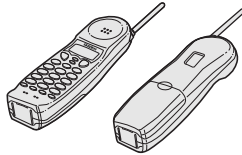

- 4** Place the handset on the base.

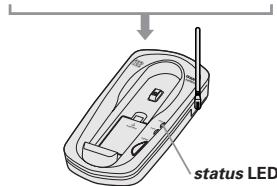

- 5** Make sure that the "*status*" LED lights. If the LED doesn't light, check to see that the AC adapter is plugged in and that the handset makes good contact with the base charging contacts.



Use only Uniden Battery (BT-999) supplied with your phone.

NOTE

Please visit your authorized Uniden dealer to obtain an extra battery pack or contact the Uniden parts department at (800) 554 - 3988. Hours are from 8:30 a.m. to 5:00 p.m. Central time, Monday through Friday.

NOTE

Even when the battery pack is not being used, it will gradually discharge over a long period. For optimum performance, be sure to return the handset to the base unit after a telephone call for charging the battery.

NOTE

Rechargeable batteries have a memory effect that reduces standby and talk time. To avoid this memory effect, on a monthly basis, use the phone until the "Low Battery" appears. Then charge the battery for more than 17 hours.

Charging optional battery packs

The base unit of your phone is equipped with a compartment for charging an extra battery pack for use in your handset.

1. Pull the cover of battery charger.
2. Put the battery pack in the compartment with contacts facing down.
3. Replace the charger cover.
4. Charge the battery for more than 28 hours.

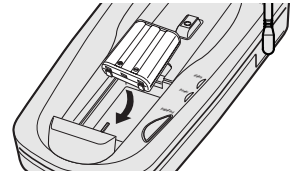

NOTE

In the event of a power failure, your spare battery pack can be used as a back-up power supply for the base unit.

Battery use time (per charge)

From fully charged

- Four hours continuous use.
- Seven days when the handset is in the standby mode.

When the battery charge becomes low

When the voltage of battery pack in the handset is very low and needs to be charged, the phone is programmed to eliminate

Low Battery

functions in order to save power. If the phone is not in use, "Low Battery" flashes and none of the keys will operate. If the phone is in use, "Low Battery" flashes and the handset beeps. Complete your conversation as quickly as possible and return the handset to the base unit for charging.

Cleaning the battery contacts

To maintain a good charge, it is important to clean the battery contacts on the handset and base unit about once a month. Use a pencil eraser or other contact cleaner.

Do not use any liquids or solvents.

NOTE

Press **(del)** if you enter a wrong number at the step 1.

NOTE

You must press a key within 20 seconds or the phone will return to standby.

Making a call

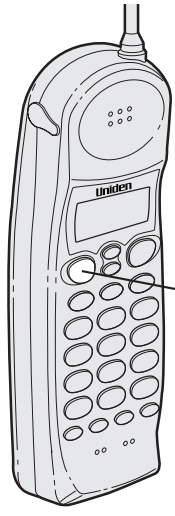

On-hook dialing

1 Enter the phone number. (Up to 32 digits.)

Example: Enter 8178583300



2 Press **(talk)**. "Talk" flashes on the display.

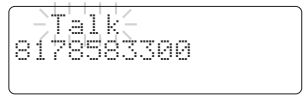

Then the volume setting is displayed. For example, if the volume is set to high the display shows.



3 The number is dialed. After about 5 seconds, the call-time display appears.

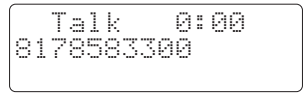

4 To hang up, press **(talk)** or place the handset on the base. The call-time will be displayed for about 5 seconds.

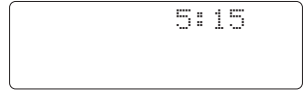

Other Operations

To	Do this
To adjust the earpiece volume	Press (▲) or (▼) .
To temporarily switch to tone dial (When the base is set to pulse mode)	Press (*tone/◀) . The following numbers dialed will be sent as tone dialing.
To enter a pause within dialing sequence	Press (redial/p) .



Off-hook dialing

- 1 Press **talk**. "Talk" flashes on the display.



Then the volume setting is displayed.
For example, if the volume is set to high the display shows:



- 2 Dial the phone number.

Example: Enter 8178583300



- 3 To hang up, press **talk** or place the handset on the base. The call-time will be displayed for about 5 seconds.

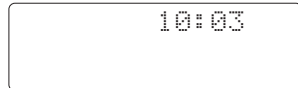

Receiving a call

From the handset



- 1** Phone rings.

Calling

- 2** Press **(talk)**. “Talk” and volume setting appears on the display.

Talk 0:00
<Normal>

- 3** Talk with the caller.

Talk 0:02

- 4** To hang up, press **(talk)** or place the handset on the base. The call time will be displayed for about 5 seconds.

1:15:35

AutoTalk when ringing

When the AutoTalk setting is on and there is an incoming call, simply lift the handset from the base unit to answer the phone. See “Setting Caller ID options” on page 27 for more details.

Any key answer when ringing

When the AutoTalk setting is on, and the handset is off the base, press any handset key to answer the incoming call.

Call Waiting

Note: You must subscribe to Call Waiting service to use this feature.

When a call is received during a telephone call already in progress, press **(flash)** to switch to the new call.

If you also subscribe to Call Waiting on Caller ID, you will see the name and number of the caller in call waiting. (See page 34.)

Adjusting the ringer and earpiece volume

Ringer volume

In the standby mode, press **(mute/ring)** on the handset to set the handset ringer volume. There are two ringer volume settings; high and low.

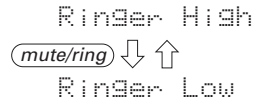

Ringer on/off switch

This switch turns the handset ringer on or off.

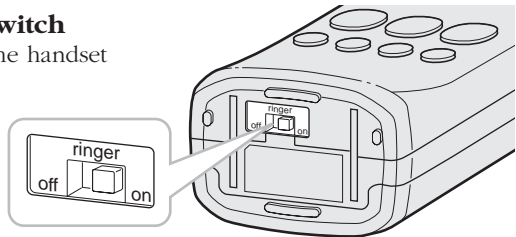

Earpiece volume

Pressing **(▲)** or **(▼)** will change the earpiece volume of the handset. This setting will remain in effect after the telephone call has ended.

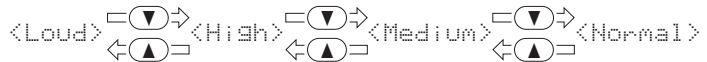

When you press **(▲)** in Loud mode or press **(▼)** in Normal mode, error sound beeps.

Redialing a call

The last three phone numbers dialed can be quickly redialed.

NOTE

If the number exceeds 32 digits, only the first 32 digits are retained for redialing.

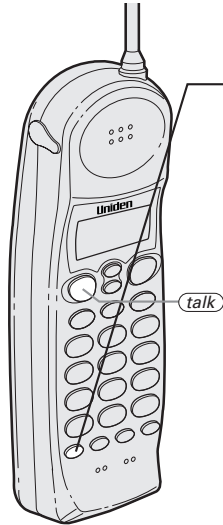

On-hook redialing

- 1 Press **redial/p**.
The phone number that was last dialed appears on the display.
- 2 Press **redial/p** again.
Each press of **redial/p** will display one of the last three numbers dialed.

Most recent

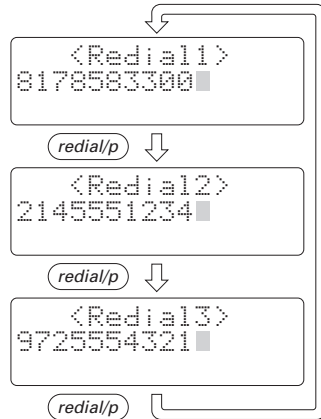

- 3 Press **talk**. "Talk" appears on the display, then the volume setting is displayed.
- 4 Then the selected number is dialed. After about 5 seconds, the call-time display appears.
- 5 To hang up, press **talk** or place the handset on the base. The call-time will be displayed for about 5 seconds.

Off-hook redialing



- 1** Press **(talk)**.
“Talk” appears flashing on the display.



- 2** Press **(redial/p)**.
The last number dialed will be displayed.

- 3** To hang up, press **(talk)** or place the handset on the base. The call-time will be displayed for about 5 seconds.



Only the last number dialed can be accessed after **(talk)** has been pressed.

NOTE

In memory dialing operation, you must press a key within 20 seconds or the phone will return to standby. If you return the handset in the cradle the phone will return to standby too.

TELEPHONE

FEATURES

Storing phone numbers and names

Memory Dialing allows you to dial a number using just a few key strokes. You can store up to 20 phone numbers in the memory.

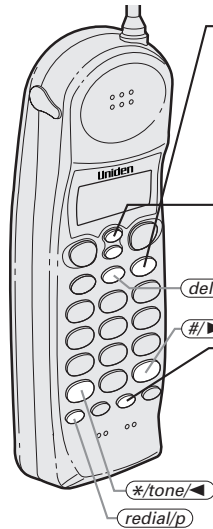

- 1 Press and hold **(mem)** until "Memory Store" is displayed.

```
Memory Store
01#
02
```

- 2 Press **(▼)** and **(▲)** or enter a two-digit number (01 - 20) to select the memory location where you would like to store the number.

- 3 Press **(select)**.
The following screen appears and a cursor flashes indicating that the display is ready for the name to be entered.

```
Store Name
█
```

If this screen appears, the selected memory location is already stored. Then you must either change the entry in this location, clear the location or select "Go Back" to choose another location.

```
Edit Memory07
Delete Memory07
Go Back
```

- 4 Use the **(▲)**, **(▼)**, or **(del)** keys to enter the name. The name cannot exceed 13 characters.
 - Use the **(▲)** and **(▼)** key to scroll through the character menu. It contains upper and lower case letters and various characters.
 - Use **(#/▶)** and **(*/tone/◀)** to move the cursor to the desired location.
 - Use **(del)** key to delete characters as needed.

- 5** Press **(select)**.
“Store Number” is displayed. The cursor flashes indicating that the display is ready for the number to be entered.

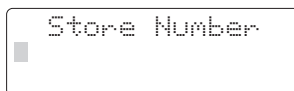

Store Number

- 6** Use the number keypad to enter the phone number. The phone number cannot exceed 20 digits.

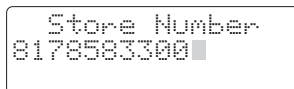

Store Number
0176583300

- Use the **(redial/p)** key to enter pause in the dialing sequence. The display shows a “P”.



The pause feature is useful for long distance calling, credit card dialing, or sequences that require a pause between digits.

- Use the **(del)** key to delete digits as needed.

- 7** Press **(select)**.
The handset beeps and displays the confirmation screen. Memory storage is complete.

For example, if you store a name and number into memory location number 07, the display shows “Memory07 Stored”.

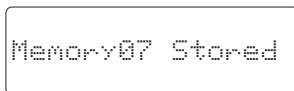

Memory07 Stored

After about 2 seconds, “Memory Store” is displayed.

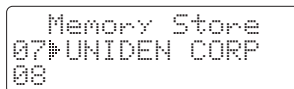

Memory Store
07 UNIDEN CORP
08

- 8** Press **(mem)** to return to standby mode.

Making calls with memory dialing

On-hook memory dialing

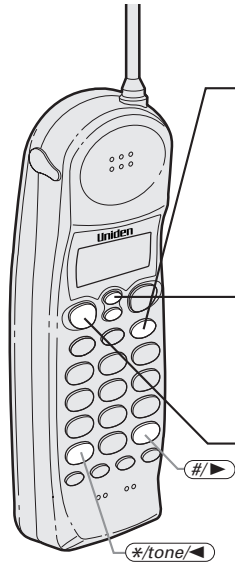

- 1 Press **mem**.
The handset displays your programmed memory locations.

```
01 UNIDEN CORP
02 JOHN DOE
03#MOM AND DAD
```

- 2 Press **▼** and **▲** or enter a two-digit number (01 - 20) to select the memory location you would like to dial.

- 3 Press **talk**. "Talk" flashes and the volume setting appears on the display. Then the displayed number is dialed.

```

      *///
-Talk-
0123456789012
```

NOTE

If you press **select** before **talk**, you can confirm the name and number stored in the selected memory location.

NOTE

To exit the memory function without dialing, press **mem**. The handset returns to standby.

Display a Programmed Number

Use the **#/▶** and ***/tone/◀** keys to toggle between the names display and the numbers display.

Program name

```
01 UNIDEN CORP
02 JOHN DOE
03#MOM AND DAD
```

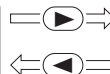

Program number

```
01 8178583300
02 5452930
03#8175551212
```

NOTE

When the stored phone number has 13 or more digits, "➔" is displayed next to the 12th digit. Press **#/▶** to see the extra digits and ***/tone/◀** to return.

```
05 012345678901
06#011813554329+
07
```

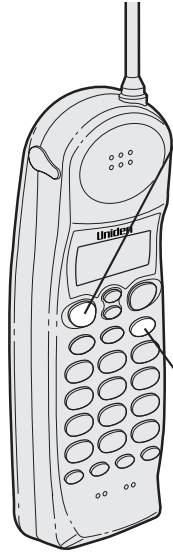

Off-hook memory dialing

- 1** Press **talk**.
“Talk” flashes and the volume setting appears.

```
  Talk  <High>
```



```
  Talk  <High>
```

- 2** Press **mem**.

```
  Talk  0:00
```

- 3** Enter a two-digit number (01 - 20) to select the memory location of the desired phone number.
The selected phone number is displayed. Then the number is dialed.

```
  Talk  0:35  
0123456789012
```

Editing a stored name and/or phone number

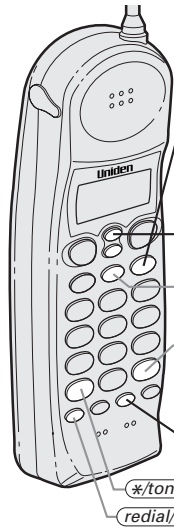

- 1** Press and hold **(mem)** for 2 seconds. The display shows the memory screen and any saved name/number.

```
Memory Store
01 UNIDEN CORP
02 JOHN DOE
```

- 2** Press **(▼)** and **(▲)** or enter a two-digit number (01 - 20) to select the memory location you would like to edit.

```
Memory Store
01 UNIDEN CORP
02 JOHN DOE
```

- 3** Press **(select)**. The following screen appears with the memory location number that you have selected in the display.

```
#Edit Memory01
Delete Memory01
Go Back
```

- 4** Press the **(▲)** or **(▼)** key to select "Edit Memory", then press **(select)**.

```
Store Name
UNIDEN CORP█
```

The following screen appears.

The cursor flashes indicating that the display is ready for the name to be edited. When a name has not been stored, the cursor appears at the beginning of the second line.

- 5** Press **(▲)**, **(▼)**, **(#/▶)**, **(*/tone/◀)**, or **(del)** to edit the name. (See page 18.)

To edit only the phone number, skip this step.

- 6** Press **(select)**.

The following screen appears. The cursor flashes indicating that the display is ready for the number to be edited.

```
Store Number
017858330█
```

7 Use the dial keypad, **(redial/p)** or **(del)** key to edit the phone number.

The phone number cannot exceed 20 digits. (See page 19.)
If you don't want to change the phone number, skip this step.

8 Press **(select)**.
The handset beeps and displays the confirmation screen. The memory storage is complete.

```
Memory01 Stored
```

For example, if you store a name and number into memory location number 01, the display shows "Memory01 stored".

After about 2 seconds, "Memory Store" is displayed.

```
Memory Store
01# UNIDEN CORP
02# JOHN DOE
```

9 Press **(mem)** to return to standby mode.

Display a Programmed Number

Use the **(#/▶)** and **(*/tone/◀)** key to toggle between the names display and the numbers display.

Program name

```
Memory Store
01 UNIDEN CORP
02# JOHN DOE
```



Program number

```
Memory Store
01 8178583300
02# 5452930
```



- When the stored phone number has 14 or more digits, "➔" is displayed next to the 12th digit.

Press **(#/▶)** to see the extra digits and **(*/tone/◀)** to return.

```
Memory Store
06# 011813554329+
07
```



```
Memory Store
+300000
```



Erasing a stored name and phone number

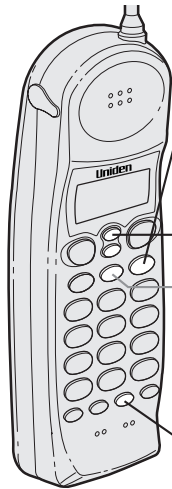

- 1** Press and hold **(mem)** until the display shows the memory screen and any saved name/number.

```
Memory Store
01 UNIDEN CORP
02 JOHN DOE
```

- 2** Press **(v)** and **(^)** keys or enter a two-digit number (01 - 20) to select the memory location you would like to edit.

```
Memory Store
01 UNIDEN CORP
02 JOHN DOE
```

- 3** Press **(select)**.
The following screen appears with the memory location number that you have selected in the display.

```
Edit Memory02
Delete Memory02
Go Back
```

- 4** Press **(v)** to move the cursor down to "Delete Memory" command line.

```
Edit Memory02
Delete Memory02
Go Back
```

- 5** Press **(select)**. The following confirmation screen appears.

```
Delete Memory02?
Yes
No
```

- 6** Press **(^)** to move the cursor to "Yes".

- 7** Press **(select)** or **(del)**.
There is a confirmation tone and the entry is deleted. The following screen appears.

```
Memory02 Deleted
```

- 8** After a few seconds the display returns to the "Memory Store" screen. You may select another number to delete (return to step 2) or press **(mem)** to return to standby.

```
Memory Store
02
03 MOM AND DAD
```

Paging

To locate the handset

NOTE

By holding **page/find** for more than 2 seconds, the handset beeps for 60 seconds.

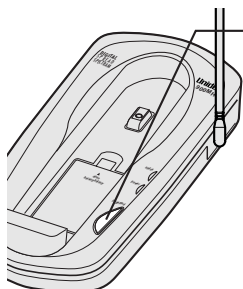

- 1 Press **page/find** on the base.
- 2 The handset beeps for 5 seconds. The following screen appears:

- 3 Press any key on the handset to end.

NOTE

When an incoming call is received during paging, paging is stopped and the telephone is switched to the incoming call.

NOTE

If you press **talk** during paging, the handset will be placed in off-hook (talk) mode.

NOTE

Paging cannot be performed while the handset is in use.

Mute

You can turn off the handset microphone so that the person whom you are talking with cannot hear you.

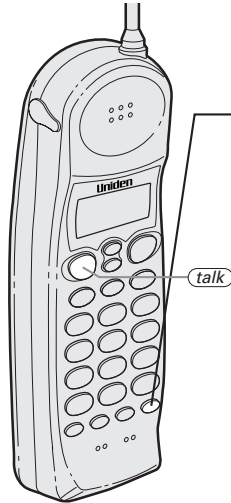

When speaking on the handset

- 1** Press **mute/ring** during a call. The microphone is turned off.
- 2** To resume a call, press **mute/ring** or **talk**.

When phone is ringing

Press **mute/ring** when the phone rings. The ringer sound is turned off.

NOTE

You must subscribe to Caller ID on Call Waiting in order to use this feature.

Caller ID

You must subscribe to the Caller ID service to use this feature.

When the telephone rings, the Caller ID feature allows you to view the caller's name and phone number on the display before you answer the phone.

The handset displays the phone number of the incoming call, the name, time, and the number of calls. Additionally, you can dial the displayed number, and store the information for memory dialing.

Setting Caller ID options

There are three Caller ID setup options available; they are AutoTalk, CIDCW (Caller ID on Call Waiting), and Area Code.

AutoTalk allows you to answer the phone without pressing the **(talk)** button. If the phone rings when AutoTalk is on, simply remove the handset from the cradle and the phone automatically answers the call. If the phone rings when AutoTalk is off, you must press **(talk)** to answer the call.

Caller ID on Call Waiting (CIDCW) performs the same as regular Caller ID on a call waiting number.

You must subscribe to CIDCW from your phone company in order to use this feature.

Area Code allows you to program your 3-digit area code number. When reviewing Caller ID messages, you will see only a seven digit number for calls received from inside your area code. For calls from outside your area code, you will see a full 10-digit number.

NOTE

If your calling area requires 10-digit dialing, do not program this option.

To change your Caller ID options:

- 1 Press **(setup)**. The following screen appears.
- 2 Use the **(▲)** and **(▼)** keys to move the cursor to the selection that you would like to change. Press the **(select)** key to toggle between On and Off for Auto Talk and CIDCW.
- 3 When you wish to enter Area Code, press **(▼)** to move the cursor to select "Area Code". Then press **(select)** and enter the 3 digits area code by using the number keypad **(0) - (9)**. After entering Area Code, press **(select)**.
- 4 After you have made your selections, press **(setup)** and return the handset to the charging cradle.

```
1▶Auto Talk:Off
2 CIDCW      :On
3 Area Code:
```

When the telephone rings

NOTE

If you answer a call before the Caller ID message is received (Example: before the second ring), the Caller ID message will not appear.

NOTE

When the call is received via a telephone company that does not offer Caller ID service, the caller's phone number and name do not appear. (This includes international calls.)

NOTE

When the call is via a private branch exchange (PBX), the caller's phone number and name may not appear.

- When the Caller ID message is received, the display shows the caller's phone number, along with the date and time. The incoming call information is stored in Caller ID record. If the Caller ID service includes the caller's name, the caller's name appears on the display (up to 15 letters).

The date and time received — 5/11 12:30PM 01
Caller's name — UNIDEN CORP
Caller's phone number — 817-858-3300

Here are some typical displays;

When the phone number and name data are received

```
5/11 12:30PM 01
UNIDEN CORP
817-858-3300
```

When invalid data is received

```
Incomplete Data
```

When a private name is received

```
5/11 12:30PM 01
Private Name
817-858-3300
```

When a private number is received

```
5/11 12:30PM 01
UNIDEN CORP
Private Number
```

When an unknown name is received

```
5/11 12:30PM 01
Unknown Name
817-858-3300
```

When an unknown number is received

```
5/11 12:30PM 01
UNIDEN CORP
Unknown Number
```

- When you pick up the phone, the display changes to "Talk". (See page 14.)

NOTE

Data errors appear as "■ ■".

```
5/11 12:30PM 01
UNI■EN CORP
813-8■■-3300
```

NOTE

In Caller ID operation, if no key is pressed for more than 20 seconds, an error tone sounds and the telephone returns to the standby mode.

NOTE

If a call comes in via a telephone system that does not offer Caller ID service, no information is stored.

NOTE

"End" appears when you have reviewed all messages in the Caller ID list. Press **▲** repeatedly to return to the summary screen.

NOTE

Each message can be up to 15 characters for the phone number and the name.

Viewing the Caller ID Message list

The Caller ID list stores information for up to 50 incoming calls - even unanswered calls.

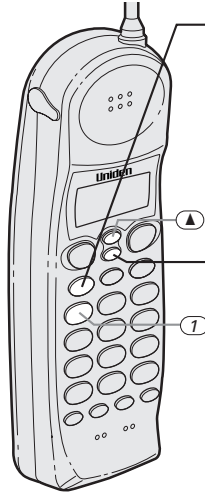

- 1 Press **call id** .
The summary screen appears.
The screen shows the number of new messages and total messages.

```
New :01
Total:02
```

- 2 Press **▼** to display the latest caller ID message.

```
5/17 12:30PM 03
UNIDEN CORP
817-858-3300
```

- 3 Press **▼** to see the next message.
Or press **▲** to see previous message.

- 4 Press **call id** to return to standby.

Long Distance call setting and cancellation

Press **1** while the incoming call information is displayed

(in step 2) to return a long distance call. The prefix "1-" will

be displayed at the beginning of the phone number when a long distance call is set. (When the phone number is 15 digits long, only "1" is displayed.) Pressing **1** again will cancel the long distance call setting.

```
5/17 12:30PM 03
UNIDEN CORP
1-817-858-3300
```



Deleting information from the Caller ID list

The EXS 9960 stores up to 50 messages. If the phone receives the 51st message, the oldest one in the list is automatically deleted. Caller ID data can also be deleted manually.

Deleting a Caller ID message

NOTE

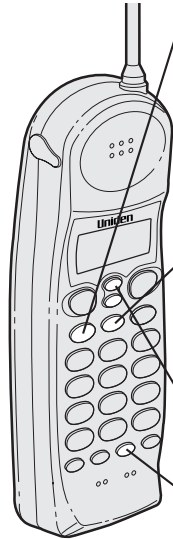
If you get an incoming call, the deleting operation is cancelled. The telephone returns to standby so you can answer the call.



1 Press **(call id)**.

Display the message to be deleted from the Caller ID list by pressing

(v) or **(^)**.

```
5/17 12:30PM 03
UNIDEN CORP
817-858-3300
```

2 Press **(del)**.

```
Delete Message ?
#Yes
No
```

3 Press **(v)** or **(^)** to select "Yes" or "No".

4 Press **(select)** or **(del)**.

When the pointer is at "Yes":

A tone sounds and the next Caller ID message is displayed.

When the pointer is at "No":

The display returns to the Caller ID display.

NOTE

If you get an incoming call, the deleting operation is cancelled and the telephone returns to standby so you can answer the call.

Deleting all Caller ID name/numbers



1 Press **(call id)**.

```
New :01
Total:02
```

2 Press **(del)**.

```
Delete All ?
Yes
#No
```

3 Press **(▲)** or **(▼)** to select "Yes" or "No".

4 Press **(select)** or **(del)**.

When the pointer is at "Yes":

A tone sounds and all stored Caller ID messages are deleted.

```
Total:00
```

When the pointer is at "No":

The display returns to the summary screen.

```
New :01
Total:02
```

Using the Caller ID list

Calling a party from the Caller ID list

You can place a call from the Caller ID list.
The EXS 9960 stores up to 50 messages.

NOTE

You cannot make a call from the Caller ID list if your EXS 9960 is connected to private branch exchange (PBX).

NOTE

When a long distance call has been set, "1" appears in the display.

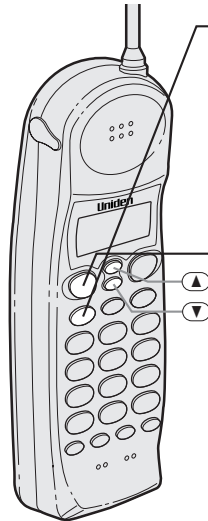

- 1** Press **call id**.
Select the phone number that you want to dial by pressing **▲** or **▼**.

```
5/17 12:30PM 03
UNIDEN CORP
817-858-3300
```

- 2** Press **talk**.

```
Talk
8178583300 ■
```

The displayed phone number dials automatically.

Long Distance calls

Pressing **1** while the incoming call information is displayed (in step 1) will set or cancel a long distance call.

Dial edit

You can edit the phone number of Caller ID data when you press **select** after the step 1.

Storing Caller ID messages in Memory dialing

Messages shown in the Caller ID list can be stored in memory dialing.

Using the incoming call information (i.e., Caller ID list), the phone number of the party on the Caller ID list can be stored in memory dialing.

NOTE

You can not store a Caller ID message, if no phone number appears in the message.

NOTE

If there is an incoming call or page, memory storage is cancelled and the telephone is set to receive the incoming call or page.

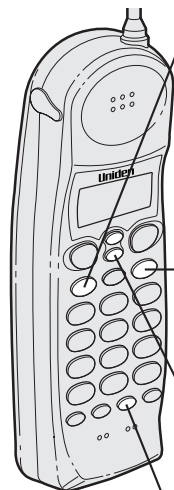

- 1** Press **(call id)**.
Select the phone number to be stored from the Caller ID list by pressing **(▲)** or **(▼)**.

```
5/17 12:30PM 03
UNIDEN CORP
817-858-3300
```

- 2** Press **(mem)**.

```
Select Location
1 UNIDEN CORP
2 JONE DOE
```

- 3** Press **(▼)** or **(▲)** to select the memory location. Or press the dial button (**(0)** to **(9)**) and select the number (01 - 20).

- 4** Press **(select)**.

A tone will sound. The number is stored in memory, and the display returns to the Caller ID list.

```
5/17 12:30PM 03
UNIDEN CORP
817-858-3300
```

NOTE

If a message has already been stored in the selected memory numbers location, a confirmation screen is displayed. Press **(▲)** to select "Yes". Press **(select)** to overwrite. The display returns to the Caller ID list.

```
Replace Memory ?
Yes
▶ No
```

Using "Caller ID on call waiting" service

"Caller ID" and "Call waiting" are separate services. CIDCW (Caller ID on Call Waiting) performs the same as regular Caller ID on a call waiting number. You must subscribe to the "Caller ID on call waiting (CIDCW) services" before you can use the following features. The "Call waiting" service can also be used independently. Please contact your local telephone company for details.

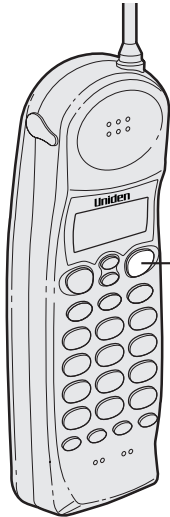

- 1** When a new incoming call arrives during your current telephone call, the phone number and the name of the caller is displayed.

```
Talk 10:30
UNIDEN CORP
817-858-3300
```

- 2** Press **(flash)**.
You will be able to talk with the second caller. The first caller will be put on hold.
- 3** To return to the first caller, press **(flash)** again.

NOTE

If the handset battery pack is completely discharged or the battery pack is removed, the digital security code will be lost. If this happens, a new security code is set automatically next time the battery pack is charged.

Changing the digital security code

The digital security code is an identification code used to connect the handset and the base unit. Normally, setting the code is not necessary.

The first time you charge your handset, the security code is automatically set. (See page 3.)

In the rare situation that you suspect another cordless telephone is using the same security code, you can change the code.

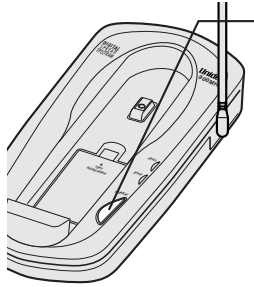

- 1** Remove the handset from the base unit. Press and hold **(page/find)**.
- 2** While the handset is producing the paging sound, hold **(page/find)** and replace the handset on the base unit. The paging tone stops. Leave the handset on the base longer than 5 seconds. A random, new security code is set.

NOTE

If you have wall mounted the base, you must remove the beltclip to charge the handset facing forward.

Installing the beltclip

To attach the beltclip

Insert the beltclip into the holes on each side of the handset. Press down until it clicks.

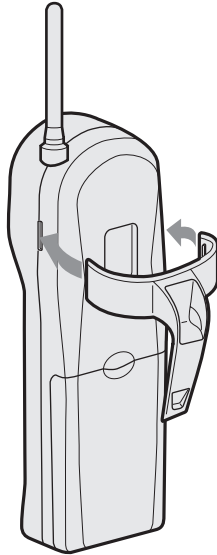

To remove the beltclip

Pull both sides of the beltclip to release the tabs from the holes.

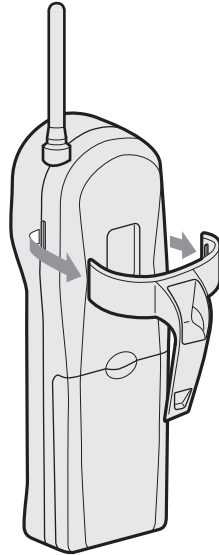

Headset installation

Your phone may be used with an optional headset. To use this feature, simply plug any standard 2.5mm headset plug into the headset jack. Your phone is ready for hands-free conversation.

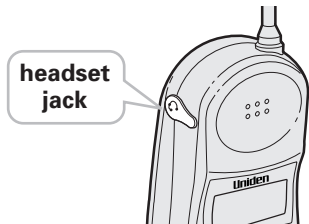

Note on power sources

Battery replacement and handling

When the operating time becomes short, even after a battery is recharged, please replace the battery.

With normal usage, your battery should last about one year.

Please contact your place of purchase for a replacement battery.

Power Failure

During the period that the power is off, you will not be able to make or receive calls with the telephone.

RECYCLING NICKEL-CADMIUM BATTERIES

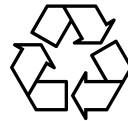

Ni-Cd

NICKEL-CADMIUM BATTERIES MUST BE DISPOSED OF PROPERLY.

Nickel-cadmium cells are used in the battery pack. Please take your used nickel-cadmium battery packs to a store that recycles nickel-cadmium batteries.

Caution

- Use the specified battery pack.
- Do not remove the battery from the handset to charge it.
- Never throw the battery into a fire, disassemble it, or heat it.
- Do not remove or damage the battery casing.

Maintenance

When slightly dirty

Wipe with a soft, dry cloth.

When very dirty

Wipe with a soft cloth that has been dampened with diluted, neutral detergent. Dry with a dry cloth.

When the charging terminals become dirty

Wipe with a pencil eraser or other contact cleaner.

Caution

Do not use paint thinner, benzene, alcohol, or other chemical products. Doing so may discolor the surface of the telephone and damage the finish.

Troubleshooting

If your phone is not performing to your expectations, please try these simple steps first.

Symptom	Suggestion
The status LED won't come on when the handset is placed in the base unit.	<ul style="list-style-type: none"> • Make sure the AC adapter is plugged into the base unit and wall outlet. • Make sure the handset is properly seated in the base unit. • Make sure the charging contacts on the handset and base unit are clean.
The audio sounds weak and/or scratchy.	<ul style="list-style-type: none"> • Make sure that the base unit antenna is in a vertical position. • Move the handset and or base unit to a different location away from metal objects or appliances and try again. • Make sure that you are not too far from the base.
Can't make or receive calls.	<ul style="list-style-type: none"> • Check both ends of the base unit telephone line cord. • Make sure the AC adapter is plugged into the base unit and wall outlet. • Disconnect the AC adapter for a few minutes, then reconnect it. • Reset the digital security code (See page 35). • Make sure (talk) is pressed.
The handset doesn't ring or receive a page.	<ul style="list-style-type: none"> • The battery pack may be weak. Charge the battery on the base unit for more than 17 hours. • The handset may be too far away from the base unit. • Place the base unit away from appliances or metal objects. • Reset the digital security code (See page 35). • Make sure the ringer switch is set on (See page 15).
The Caller ID does not display.	<ul style="list-style-type: none"> • The handset was picked up before the second ring. • The call was placed through a switch board. • Call your local telephone company to verify your Caller ID service is current.

Specifications

General

The EXS 9960 complies with FCC Parts 15 and 68.

Frequency control: PLL
 Modulation: Direct Sequence Spread Spectrum; DBPSK
 Operating temperature: 0°C to +50°C (+32°F to +122°F)

Base unit

Frequency: 904.2 MHz to 925.8 MHz (20 channel)
 Power requirements: 9V 350mA (from AC adapter)
 Size: 5-5/32 in. (W) x 2-1/2 in. (D) x 8-57/64 in. (H)
 (131 mm (W) x 63.6 mm (D) x 226 mm (H))
 Weight: Approx. 15.7 oz. (445 g)
 (including optional battery)

Handset

Frequency: 904.2 MHz to 925.8 MHz (20 channel)
 Power requirements: Rechargeable Nickel-Cadmium battery pack
 Size (without antenna): 2-17/64 in. (W) x 2-1/32 in. (D) x 7-1/64 in. (H)
 (57.6 mm (W) x 51.7 mm (D) x 178 mm (H))
 Weight: Approx. 9.4 oz. (267 g) (including battery)
 Battery: BT-999
 Capacity: 600 mAh, 3.6V
 Talk mode: 4 hours TYP
 Standby mode: 7 days TYP

Specifications, features, and availability of optional accessories are all subject to change without prior notice.

At Uniden, we'll take care of you!

If you need any assistance with this product, please call our Customer Hotline at

1-800-297-1023

PLEASE DO NOT RETURN THIS PRODUCT TO THE PLACE OF PURCHASE.

Our Uniden representatives will be happy to help you with any matters regarding the operation of this unit, available accessories, or any other related matters.

Thank you for purchasing a Uniden product.
 Hours: M-F 7:00 AM to 7:00 PM CST.

Index

A

Adjusting ringer and earpiece volume15

B

Battery pack
 Preparing and charging..10
 Replacement and handling37

C

Caller ID
 Caller ID service27
 Call Waiting.....34
 Deleting.....30
 Using32
 Viewing29
 Connection.....6

D

Dialing mode7
 Digital security code3, 35

E, F, G

Earpiece volume.....15

H

Headset installation36

I, J, K, L

Installing the beltclip.....36

M, N, O

Maintenance37
 Making a call12
 Memory dialing
 Making calls
 with memory dialing.....20
 Erasing a stored name
 and phone number24
 Storing phone
 numbers and names.....18
 Mounting the base unit
 on a wall.....8
 Mute26

P, Q

Package contents.....4
 Paging25

R

Receiving a call14
 Redialing a call16
 Ringer volume15

S

Setting up the Base unit5
 Setting up the Handset10
 Specifications39

T, U, V, W, X, Y, Z

Troubleshooting.....38

THANK YOU

FOR PURCHASING A UNIDEN PHONE!

Uniden®

Covered under one or more of the following U.S. patents:

4,511,761 4,523,058 4,595,795 4,797,916 5,381,460
5,426,690 5,431,905 5,491,745 5,533,010 5,574,727
5,650,790 5,660,269 5,661,780 5,663,981 5,671,248
5,717,321 5,754,407 5,768,345 5,787,356 5,838,721

© July 1999 Uniden America Corporation

All rights reserved • Printed in China UCZZ01647BZ

Free Manuals Download Website

<http://myh66.com>

<http://usermanuals.us>

<http://www.somanuals.com>

<http://www.4manuals.cc>

<http://www.manual-lib.com>

<http://www.404manual.com>

<http://www.luxmanual.com>

<http://aubethermostatmanual.com>

Golf course search by state

<http://golfingnear.com>

Email search by domain

<http://emailbydomain.com>

Auto manuals search

<http://auto.somanuals.com>

TV manuals search

<http://tv.somanuals.com>