

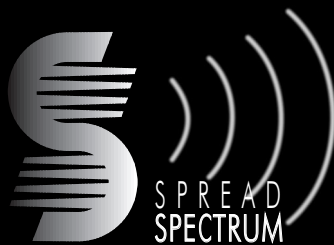

THE EXS 9965



# OWNER'S MANUAL

Digital Spread Spectrum

provides the longest

range, the clearest sound

and the best privacy.

**Uniden®**

# CONTROLS AND FUNCTIONS

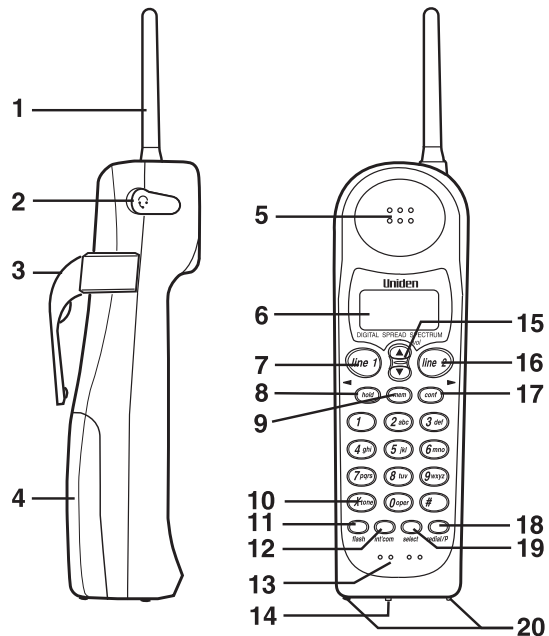

1. Handset Antenna
2. Headset Connection
3. Belt Clip
4. Handset Battery Compartment
5. Handset Speaker
6. LCD Display
7. Line 1 Key
8. Hold Key/◀Key
9. Memory Key
10. Tone Key
11. Flash Key
12. Intercom Key
13. Handset Microphone
14. Handset Ringer Switch
15. Volume/  
Cursor Up and Down/  
Character Select Key
16. Line 2 Key
17. Conference Key/▶Key
18. Redial/Pause Key
19. Select Key

20. Handset Contacts
21. Handset Retainer
22. Line 1 Status LED
23. Status LED
24. Memory Key
25. Page/Intercom Key
26. Redial/Pause Key
27. Flash Key
28. Base Contacts
29. Tone Key
30. Base Speaker
31. Line 1 Key
32. Conference Key
33. Line 2 Key
34. Line 2 Status LED
35. Hold Key
36. Mute Key
37. Base Antenna
38. Wall Mount Adapter
39. Base Speaker Volume Adjust
40. Base Microphone
41. Ring Volume Switch
42. Pulse-Tone Switch
43. DC Power Input
44. Phone Jack (2nd Line)
45. Phone Jack (1- and 2-line)

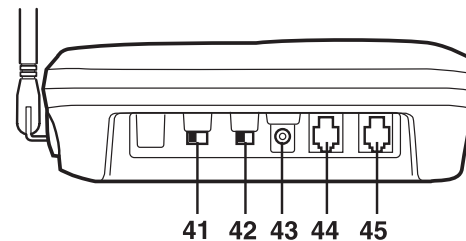
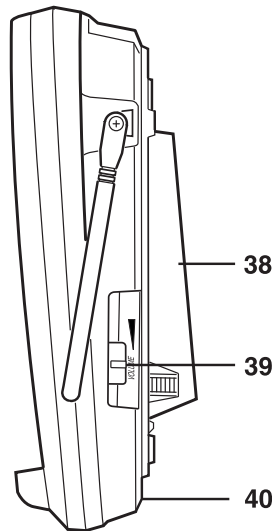
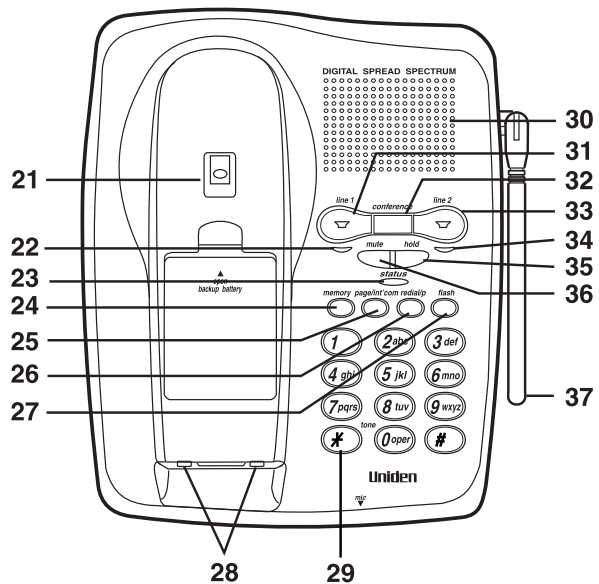

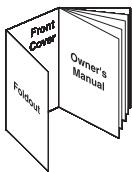

Fold out the front cover of this owner's manual to use the handy CONTROLS AND FUNCTIONS page for reference.

# CONTENTS

OF YOUR OWNERS MANUAL

## CONTENTS

<b>Controls and Functions . . . Inside Front Cover</b>	
<b>Introduction to Your New Phone . . . . .</b>	<b>2</b>
Features . . . . .	2
Included in Your Package . . . . .	3
<b>Installing and Adjusting Your Phone . . . . .</b>	<b>4</b>
Selecting a Location . . . . .	4
Desk/Tabletop Installation . . . . .	5
Wall Installation . . . . .	6
Installing the Handset Battery Pack . . . . .	9
Charging the Battery Pack . . . . .	10
Cleaning the Battery Contacts . . . . .	11
Setting the Pulse-Tone Switch . . . . .	11
Adjusting the Volume Controls . . . . .	12
Installing the Beltclip . . . . .	13
Headset Installation . . . . .	14
Automatic Digital Code Security . . . . .	14
<b>Using Your New Phone . . . . .</b>	<b>15</b>
Making and Receiving Calls . . . . .	15
Answering a Call from the Base . . . . .	16
Answering a Call from the Handset . . . . .	17
Making a Call from the Base . . . . .	17
Making a Call from the Handset . . . . .	17
Using the Tone Feature . . . . .	18
Flash . . . . .	18
Using Redial . . . . .	19
Placing a Call on Hold . . . . .	19
Using the Mute Feature . . . . .	20
Using the Page Feature . . . . .	20
2-Line Operation . . . . .	21
3-Way Conferencing . . . . .	22
4-Way Conferencing . . . . .	23
Using Your EXS 9965 Intercom . . . . .	24
Transferring a Call . . . . .	25
Traveling Out-of-Range . . . . .	26
Storing a Phone Number in Memory . . . . .	27
Editing a Phone Number in Memory . . . . .	29
Erasing a Number from Memory . . . . .	31
Using Memory Dialing . . . . .	33
<b>Troubleshooting Your New Phone . . . . .</b>	<b>35</b>
Quick Reference Chart . . . . .	35
<b>Specifications . . . . .</b>	<b>36</b>
General . . . . .	36
Base Unit . . . . .	36
Handset . . . . .	36

Introduction

Installing and Adjusting

Using Your New Phone

Troubleshooting

Specifications

### WELCOME

Congratulations on your purchase of the Uniden EXS 9965 cordless telephone. This phone is designed for reliability, long life, and outstanding performance utilizing the latest 900 MHz Spread Spectrum Technology.

### FEATURES

- 900 MHz Digital Spread Spectrum Technology
- 2-Line Operation
- 3 and 4-Way Conference Calling
- Speakerphone
- Back-up Power Supply (Requires Optional Battery Pack)
- 3-Line, 16 Character LCD Handset Display
- Backlit keypad
- Headset Compatible
- Handset Earpiece and Ringer Volume Control
- 20 Channel AutoScan
- 40 Memory Dialing Locations
- 3 Number Redial Memory
- 2-way Page/Intercom
- Hearing Aid Compatible
- Pulse/Tone Dialing
- 7-Day Standby Battery Time
- 4-Hour Talk Time

**Digital Spread Spectrum Technology** utilizes a “wider frequency band” vs. a “single narrow band” used in standard digital transmissions. The result is a more secure conversation with the clarity of digital sound, extended range, and minimal interference from other cordless phones.

**Random Code™** digital security automatically selects one of over 65,000 codes for the handset and base. This feature prevents unauthorized calls as a result of your phone being activated by other equipment.

## INCLUDED IN YOUR PACKAGE

### TIP

To get the most from your phone, please read this owner's manual thoroughly. Be sure to complete and mail the product registration form.

### NOTE

If any of these items are missing or damaged, contact the Uniden Parts Department at (800) 554-3988. Hours are from 8:30 a.m. to 5:00 p.m. Central Time, Monday through Friday. We can also be reached on the web at [www.uniden.com](http://www.uniden.com).

### HINT

You must have a two-line subscription from your phone company to realize the capability of your two-line phone.



Handset



Base



AC Adapter



Rechargeable  
Battery



Short Telephone  
Cord



Beltclip



Long Telephone  
Cord

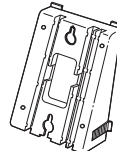

Wall Mount Adapter

- This Owner's Manual
- Precautions and Important Safety Instructions
- Registration Card

### SELECTING A LOCATION

Before choosing a location for your new phone, read the **INSTALLATION CONSIDERATIONS** included in the **PRECAUTIONS AND IMPORTANT SAFETY INSTRUCTIONS** brochure. Here are some important guidelines you should consider:

- The location should be close to both a phone jack and a continuous power outlet. (A continuous power outlet is an AC outlet which does not have a switch to interrupt its power.)
- Keep the base and handset away from sources of electrical noise such as motors and fluorescent lighting.
- Be sure there is sufficient space to rotate the base antenna fully vertical.
- The base can be placed on a desk, tabletop or mounted on a standard wall plate.
- You should charge your handset for 15-20 hours before connecting the phone line.
- If your second phone line has a separate jack, place your phone so you can access both jacks.



## NOTE

Before using your phone, charge the Nickel-Cadmium battery pack for 15-20 hours.

## DESK/TABLETOP INSTALLATION

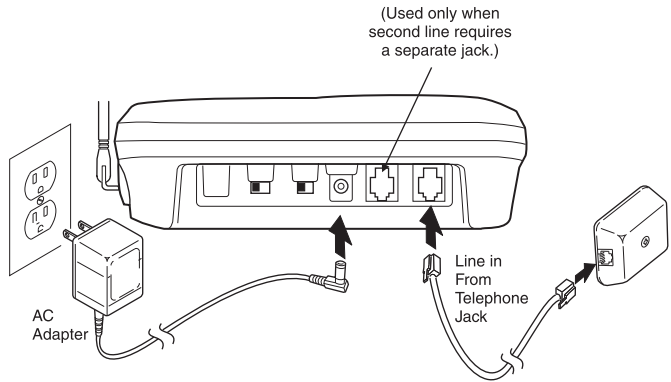

1. Plug the AC adapter cord into the 10V DC input jack on the back of the base.
2. Wrap the AC adapter cord around the strain relief notch.
3. Plug the AC adapter into a standard 120V AC wall outlet.
4. Charge the battery (refer to CHARGING THE BATTERY PACK, page 10).
5. Plug one end of the long telephone cord into the **TEL LINE 1/2** jack on the back of the base.
6. Plug the other end of the cord into the telephone jack on the wall.
7. Set the base on a desk or tabletop. Place the handset on the base with the keypad either facing up or down. Raise the antenna to a vertical position.



Place the power cord so that it does not create a trip hazard or where it could become chafed and create a fire or electrical hazard.

Use only the Uniden AC adapter supplied with this phone. DO NOT use an outlet controlled by a wall switch.

## WALL INSTALLATION

### ▼ *Standard wall plate mounting*

This phone can be mounted on any standard telephone wall plate.

- 1 Snap the wall mount adapter into the notches on the base.
- 2 Plug the telephone line cord to the **TEL LINE 1/2** jack and the AC adapter to the **DC IN 10V** jack.
- 3 Plug the telephone line cord into the telephone outlet.
- 4 Wrap the AC adapter cord inside the molded wiring channel. Then wrap the cord around the strain relief notch.
- 5 Plug the AC adapter into a standard 120V AC wall outlet.
- 6 Raise the antenna to a vertical position.
- 7 Align the mounting slots on the base with the mounting posts on the wall. Push in and down until the phone is firmly seated.

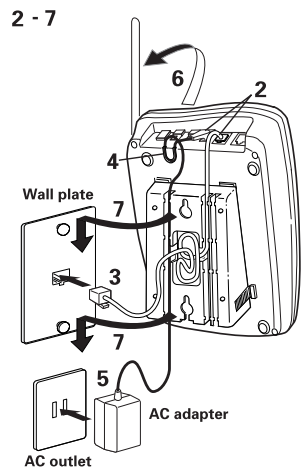
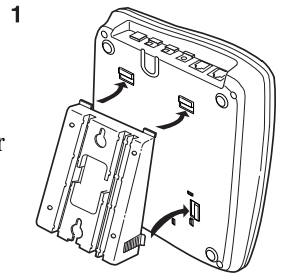

Place the power cord so that it does not create a trip hazard or where it could become chafed and create a fire or electrical hazard.



**DO NOT** use an outlet controlled by a wall switch.



**NOTE**

Before you plug the other end of the telephone cord into the modular jack on the wall, charge the battery (See CHARGING THE BATTERY PACK, page 10).

**NOTE**

If the handset beltclip is attached, you cannot charge the handset facing forward when the phone is mounted on the wall.

8. On the base unit, pull the handset retainer out of the slot. Rotate it clockwise 180 degrees.

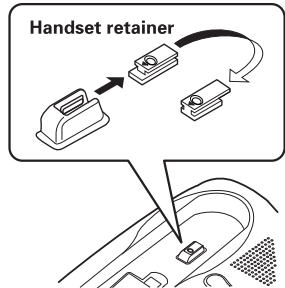

9. Flip the retainer from front to back. Slide it back into the slot so that the lip of the retainer is up and the ▼ is down. The retainer holds the handset in place.

▼ *Direct wall plate mounting*

If you don't have a standard wall plate, you can mount your phone directly to the wall. Before doing this, consider the following:

- Avoid electrical cables, pipes, or other items behind the mounting location, that could cause a hazard when inserting screws into the wall.
- Try to mount your phone within 10-15 feet of a working phone jack to avoid excessive cord lengths.
- Make sure the wall material is capable of supporting the weight of the base and handset.
- Use #10 screws (minimum length of 1 3/8 inches) with anchoring devices suitable for the wall material where the base unit will be placed.

1. Insert two mounting screws into the wall, (with their appropriate anchoring device), 3-15/16 inches apart. Allow about 3/16 of an inch between the wall and screwheads for mounting the phone.
2. Refer to steps 1 through 9 on page 6 and 7 to mount the telephone.

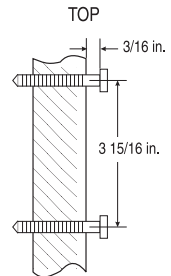

## INSTALLING THE HANDSET BATTERY PACK



Use only Uniden Battery (model BT-999) supplied with your phone.

1. Press the battery cover release.  
Slide cover off.

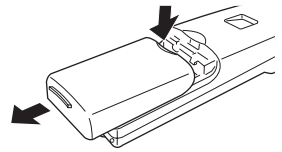

2. Install the nickel-cadmium battery with the label down.

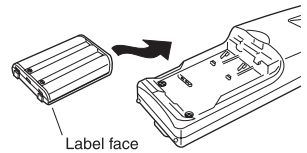

3. Slide the battery cover forward until it snaps into place.

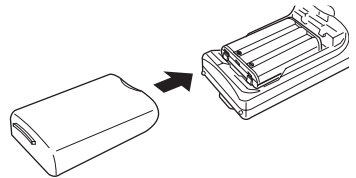

## CHARGING THE BATTERY PACK

### ▼ *Initial battery charging*

Before connecting your phone for the first time, charge the rechargeable battery pack for 15-20 hours without interruption.

1. Place the handset on the base.
2. Make sure that **status** LED lights. If the LED doesn't light, be sure the AC adapter is plugged in and the handset makes good contact with the base charging contacts.

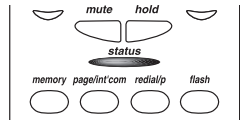

### ▼ *Charging optional battery packs*

The base of your phone is equipped with a compartment for charging an extra battery pack for use in your handset. **You can obtain an extra battery pack from your authorized Uniden dealer.**

1. Pull the cover of the battery charger.
2. Put the battery pack in the compartment with contacts facing down.
3. Replace the charge cover.

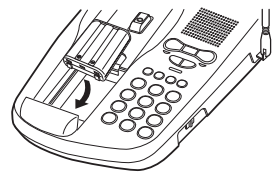

4. Charge the battery for 24 hours. When charging is complete, lift the latch to remove the battery pack. To install the charged battery into the handset, see INSTALLING THE HANDSET BATTERY PACK, page 9.

### NOTE

Please visit your authorized Uniden dealer to obtain an extra battery pack or contact the Uniden Parts Department at (800) 554-3988. Hours are from 8:30 a.m. to 5:00 p.m. Central Standard Time, Monday through Friday.

### NOTE

*In the event of a power failure, your spare battery pack temporarily provides power for the base so you can still use your phone.*

**Status LED blinks red when the base is powered by the spare battery.**

### ▼ *Low battery indicator*

When the battery pack is very low and needs to be charged, the phone is programmed to eliminate some functions to save power.

If the phone is not in use, <Low Battery> flashes.

If the phone is in use, <Low Battery> flashes and the handset beeps.

<Low Battery>

## CLEANING THE BATTERY CONTACTS

To maintain a good charge, clean all charging contacts on the handset and base about once a month.

Use a pencil eraser or other contact cleaner. **DO NOT** use liquids or solvents; you may damage your phone.

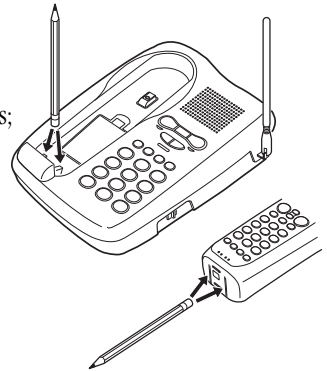

### TIP

Most phone systems use tone dialing. Check with your local phone company if you're not sure whether your system is tone or pulse.

## SETTING THE PULSE/TONE SWITCH

Be sure the **PULSE/TONE** switch is the **TONE** position unless your local phone system uses pulse dialing.

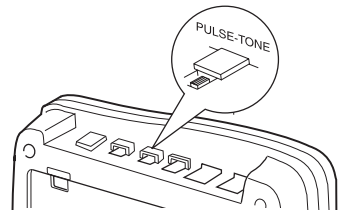

## ADJUSTING THE VOLUME CONTROLS

### ▼ Handset ringer volume

Remove the handset from the base. Press the **vol ▲** or **▼** key on the handset to set the handset ringer volume. There are two ringer volume settings; high and low.

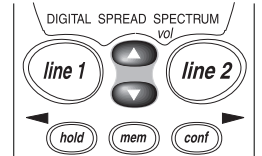

To select the high volume setting, press **vol ▲**. The following screen displays:

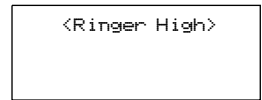

To select the low volume setting, press **vol ▼**. The following screen displays:

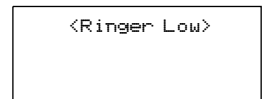

### ▼ Handset ringer switch

This switch turns the handset ringer on or off.

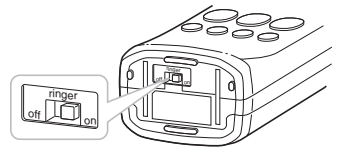

### ▼ Handset earpiece volume

There are four volume setting for the handset earpiece; loud, high, medium, and normal. The handset earpiece volume can be adjusted only during a call.

To lower the volume, press **vol ▼**. To raise the volume, press **vol ▲**. The handset displays **<Low>**, **<High>**, **<Medium>** Or **<Normal>** indicating the current volume setting.

### ▼ Base ringer volume

The ringer control for the base of your EXS 9965 allows you to turn the ringer **OFF** or to select **LO** or **HI** volume.

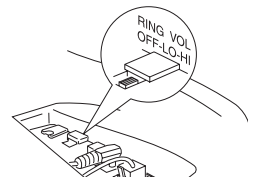

### ▼ Base speaker volume

To control the speaker volume of the base, adjust the **VOLUME** slide switch as desired.

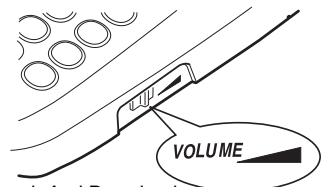



If you have wall mounted the base, you must remove the beltclip to charge the handset with facing forward.

## INSTALLING THE BELTCLIP

### ▼ *To attach the beltclip*

Insert the beltclip into the holes on each side of the handset. Press down until it clicks.

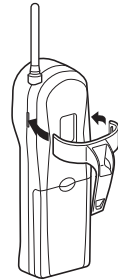

### ▼ *To remove the beltclip*

Pull both sides of the beltclip to release the tabs from the holes.

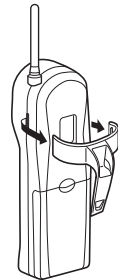

## IMPORTANT

Use only the Uniden HS910 headset specifically designed for Spread Spectrum phones. You may hear a buzz or hum on other headsets.

## NOTE

Keep the headset wire away from handset and base antennas.

## HEADSET INSTALLATION

Your phone may be used with an optional headset, the Uniden HS910. To use this feature, simply plug the headset plug into the headset jack. Your phone is ready for hands-free conversation.

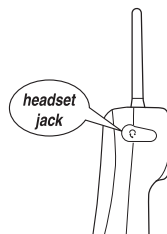

## NOTE

*If you are using an optional headset, you must still use the handset keypad for phone operations.*

## AUTOMATIC DIGITAL CODE SECURITY

To prevent other parties from making unauthorized calls on your phone line, a digital code was added to the EXS 9965. Your phone's handset and base share this code. If the phone experiences a power failure, you must reset the digital security code by placing the handset in the base.

### ▼ To reset the digital security code

1. Remove the handset from the base, hold down **page/int'com** and you will hear the beep.
2. Put handset back to the base holding **page/int'com**.  
The page stops.
3. Wait for 5 seconds. The **status** LED flashes to indicate that the digital security code is reset.

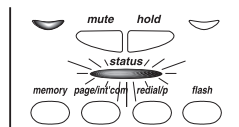



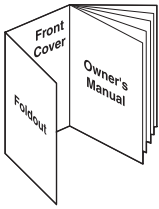



Fold out the front cover of this owner's manual to use the CONTROLS AND FUNCTIONS diagram for reference.

## MAKING AND RECEIVING CALLS

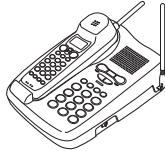
### ▼ Basic 2-line operation

	Handset On Base	Handset Off Base	Base Only
			
<b>To answer a call</b>	Pick up handset. (AutoTalk)	Press <b>line 1</b> or <b>line 2</b> .	Press <b>line 1</b> or <b>line 2</b> .
<b>To make a call</b>	<ol style="list-style-type: none"> <li>1. Pickup handset.</li> <li>2. Press <b>line 1</b> or <b>line 2</b>.</li> <li>3. Listen for dial tone.</li> <li>4. Dial number.</li> </ol> <p style="text-align: center;"><i>or</i></p> <ol style="list-style-type: none"> <li>1. Pickup handset.</li> <li>2. Dial number.</li> <li>3. Press <b>line 1</b> or <b>line 2</b>.</li> </ol>	<ol style="list-style-type: none"> <li>1. Press <b>line 1</b> or <b>line 2</b>.</li> <li>2. Listen for dial tone.</li> <li>3. Dial number.</li> </ol> <p style="text-align: center;"><i>or</i></p> <ol style="list-style-type: none"> <li>1. Dial number.</li> <li>2. Press <b>line 1</b> or <b>line 2</b>.</li> </ol>	<ol style="list-style-type: none"> <li>1 Press <b>line 1</b> or <b>line 2</b>.</li> <li>2. Listen for dial tone.</li> <li>3: Dial number.</li> </ol>
<b>To hang up</b>	Press <b>line 1</b> or <b>line 2</b> , or return the handset to the base (AutoStandby).		Press <b>line 1</b> or <b>line 2</b> .
<b>To redial</b>	<ol style="list-style-type: none"> <li>1. Pickup handset.</li> <li>2. Press <b>line 1</b> or <b>line 2</b>.</li> <li>3. Listen for dial tone.</li> <li>4. Press <b>redial</b>.</li> </ol> <p style="text-align: center;"><i>or</i></p> <ol style="list-style-type: none"> <li>1. Pickup handset.</li> <li>2. Press <b>redial</b> repeatedly until the number you want to dial appears.</li> <li>3. Press <b>line 1</b> or <b>line 2</b>.</li> </ol>	<ol style="list-style-type: none"> <li>1. Press <b>line 1</b> or <b>line 2</b>.</li> <li>2. Listen for dial tone.</li> <li>3. Press <b>redial</b>.</li> </ol> <p style="text-align: center;"><i>or</i></p> <ol style="list-style-type: none"> <li>1. Press <b>redial</b> repeatedly until the number you want to dial appears.</li> <li>2. Press <b>line 1</b> or <b>line 2</b>.</li> </ol>	<ol style="list-style-type: none"> <li>1. Press <b>line 1</b> or <b>line 2</b>.</li> <li>2. Listen for dial tone.</li> <li>3. Press <b>redial</b>.</li> </ol>

USING

YOUR NEW PHONE



***You must have a 2-line subscription from your phone company to use the 2-line features.***

When you have connected power and a telephone line to your EXS 9965, the phone is in “**Standby mode**,” ready to receive and make calls.

For clarity, the instructions in this Owner’s Manual designates line 1 unless the procedure requires using line 2. The same instructions apply to line 2.

## ANSWERING A CALL FROM THE BASE

1. The base rings. The corresponding line 1 LED on the base flashes.

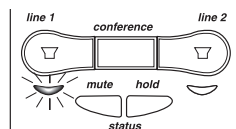

2. Press the **line 1** button and speak.

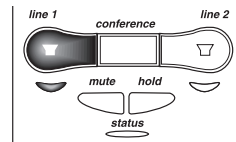

*The base microphone is located under the phone. Position yourself as near to the base as possible and speak clearly.*

3. When you finish the call, press **line 1** to hang up.

## HINT

AutoTalk automatically connect the line when you pick up the handset from the base.

## HINT

AutoStandby automatically hangs up when you place the handset on the base. There is no need to press **line 1** or **line 2** to hang up.

## ANSWERING A CALL FROM THE HANDSET

1. The handset rings and the following screen appears:
2. Press **line 1** to answer your call.
3. When you finish the call press **line 1** on the handset, or return the handset to the base.

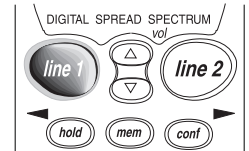
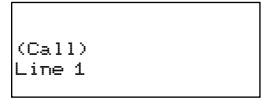

## MAKING A CALL FROM THE BASE

1. Press **line 1**.
2. Dial the number on the keypad, or, use the memory feature. (See USING MEMORY DIALING, page 33.)
3. When you finish the call, press **line 1** to hang up.

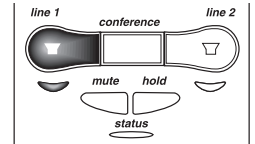

## MAKING A CALL FROM THE HANDSET

### ▼ Dialing - from talk mode

1. Pick up the handset.
2. Press **line 1**.
3. Dial the number on the keypad, or use the memory feature. (See USING MEMORY DIALING, page 33).
4. When you finish the call, press **line 1**, or, return the handset to the base.

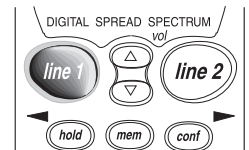

### ▼ Dialing - from standby mode

1. Pick up the handset.
2. Dial the number on the keypad, or use one of the memory features. (See USING MEMORY DIALING, page 33).
3. Press **line 1**.
4. When you finish the call, press **line 1**, or return the handset to the base.

#### NOTE

The tone feature applies only when the base is set to pulse.

#### NOTE

The flash feature does not function when **line 1** and **line 2** are on a conference call. (See the 3-WAY CONFERENCING and 4-WAY CONFERENCING, pages 22 and 23.)

## USING THE TONE FEATURE

If you are dialing in the pulse mode and need to enter tone digits, press **tone** then enter the digits. Once the call has ended, tone mode is canceled and pulse dialing resumes.

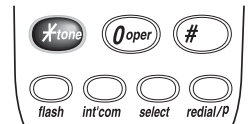

## FLASH

If you have Call Waiting service and a call waiting tone sounds, press **flash** to accept the call. After a short pause you will hear the new caller. To return to the original caller, press **flash** again. The flash function on the base and handset are independent of each other. You can use your flash feature from either the handset or the base.

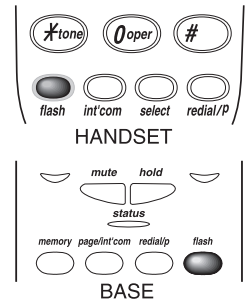

## TIP

The handset and the base have independent redial memories.

## USING REDIAL

Use the **redial/p** key to recall the last 3 numbers dialed from the handset or the last number dialed when using the base. The redial number can be up to 32 digits long.

*To redial from the handset:*

Press **redial/p** repeatedly to display the number you want to dial, then press **line 1**.

*If you press **line 1** before **redial/p**, only the last number dialed can be accessed for redial.*

*To redial from the base:*

Press **line 1**, then press **redial/p**.

*If any key is pressed before redialing, the last number will not redial.*

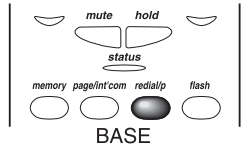
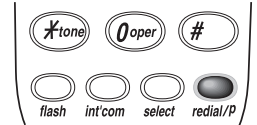

## PLACING A CALL ON HOLD

Use either the keypad on the handset or the keypad on the base.

To place **line 1** on hold at the base, press **hold**. The **line 1** LED turns from green to red.

To place **line 1** on hold at the handset, press **hold**.

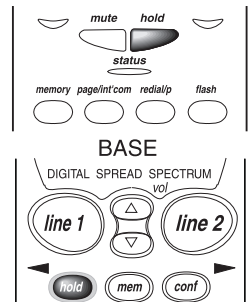

The following screen appears:

```
(Hold)  
Line 1
```

To pick up the call that is holding, press **line 1** on the base or handset.

## USING THE MUTE FEATURE

You can mute your conversation from the base. This prevents the party you are speaking to from hearing what you, or someone else in the room, is saying.

For example, to use this privacy feature while using line 1.

1. Press **mute**. The **line 1** LED flashes red.

*You can hear the party on line 1, but they cannot hear you.*

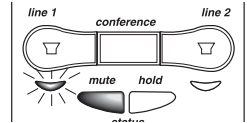

2. When you are ready to continue your conversation with the party on line 1, press **mute** or **line 1** again. The **line 1** LED changes to green.

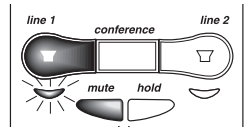

## USING THE PAGE FEATURE

To locate the handset when it is off the base, press **page/int'com** on the base.

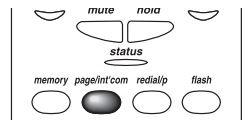

The handset beeps for 60 seconds.  
The following screen appears:

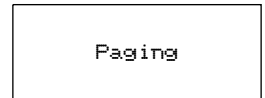

Press **int'com** on the handset to connect to the base. Press **page/int'com** again on the base or **int'com** on the handset to return to standby.

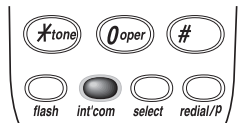

## 2-LINE OPERATION

The handset and the base can be used on separate telephone lines at the same time. For example, if the handset is on a call with **line 1**, you can make, or receive calls, at the base on **line 2**.

The **line 1** LED on the base blinks green to indicate line 1 is In Use at the handset.

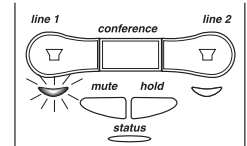

When **line 1** is In Use at the base the LCD screen displays the following:

```
(Base)  
Line 1
```

### NOTE

When you attempt to make a call, the EXS 9965 informs you if a line is currently In Use.

### ▼ Extension In Use

The Extension In Use feature prevents you from accidentally interrupting a call.

*If another phone is In Use on **line 1**, the handset LCD displays "In Use". (The **line 1** LED at the base blinks.) If you press **line 1**, you will hear a beep. This warns you the line is In Use. To make your call, you must use **line 2***

### NOTE

*If you want to join a conversation on an extension currently In Use, press the corresponding line key twice.*

## NOTE

The Flash feature does not function when the phone is in Conference mode.

## 3-WAY CONFERENCING

This feature lets you add a third party to your conversation from either the handset or the base.

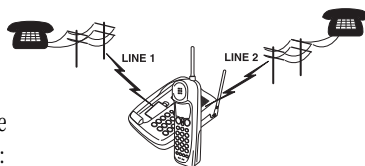

For example, to add a party to the current call on **line 1** at the base:

1. Press **hold** to place the caller on hold. The **line 1** LED turns from green to red.
2. Press **line 2**.
3. Dial the number of the person you want to add to the conversation. When the person answers, you can speak privately before bringing the original caller back on the line.
4. Press the **conference** button to bring the original call back on line. The **line 1** and **line 2** LEDs turn green.

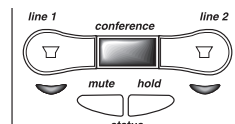
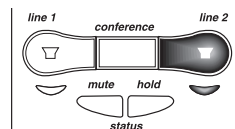
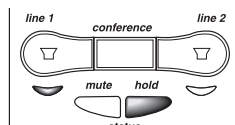

*If the third person's number is busy or doesn't answer, press **line 2** to hang up. Return to the original call by pressing **line 1**.*

5. To remove either caller from your conversation, ask one of the parties to hang up. Press the corresponding line button to end the call.

*Follow steps 1-5 to conference using the handset. When you return the handset to the base, all calls are disconnected.*

## NOTE

*If you want to join a conversation on base or handset currently in use, press **line 1** or **line 2** twice.*



## 4-WAY CONFERENCING

A fourth person, at either the handset or the base, may be added to a conference call.

For example, to add a fourth party at the handset to an ongoing conference call at the base:

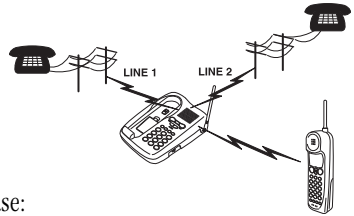

1. Press **hold**. The **line 1** and **line 2** LEDs turn red.

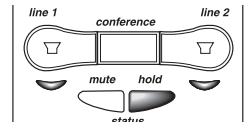

2. Press **page/int'com** on the base to contact the handset.

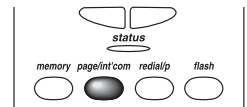

3. Press **int'com** on the handset to answer the page.

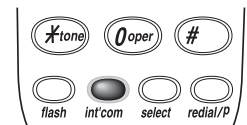

4. Press **conference** at the base to bring the party at the handset in on the call. **line 1** and **line 2** LEDs turn green.

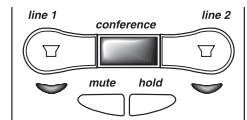

The following screen appears on the handset.

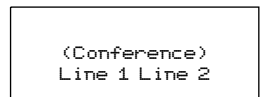

5. To remove either call from your conversation, ask one of the parties to hang up. Press the corresponding line button to end the call.



When a call is on **hold** at the handset, and the base is paged, the base will ring even when the **RING VOL** switch is set to **OFF**.



The person at the handset can join the conversation by pressing the button for the line In Use twice.

## USING YOUR EXS 9965 INTERCOM

### ▼ From the Base to the Handset

1. Press **page/int'com** on the base.  
The handset beeps. (If no answer, press **page/int'com** again to disconnect.)

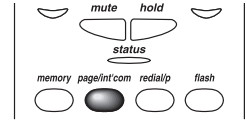

2. Press **int'com** on the handset.  
Speak into the mouthpiece to answer the page.

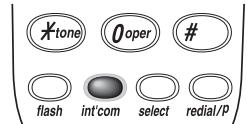

*To hang up at the base:* Press **page/int'com**.

*To hang up at the handset:* Press **int'com**.

### ▼ From the Handset to the Base

1. Press **int'com** on the handset.  
(If no answer, press **int'com** to disconnect.)

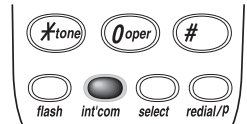

2. At the base, press **page/int'com** to answer the page.  
Position yourself as near to the base as possible and speak clearly.

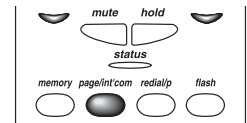

*To hang up at the handset:* Press **int'com**.

*To hang up at the base:* Press **page/int'com**.

## TRANSFERRING A CALL

### ▼ From Handset to Base

1. To transfer a call on **line 1** from the handset to the base, press **hold**.

The **line 1** LED turns red.

2. On the handset, press **int'com**.

The **status** LED flashes on the base.

The following screen appears:

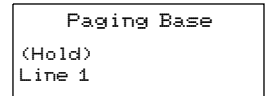
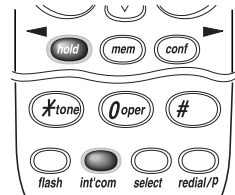

3. Answer at the base by pressing **page/int'com**. You may then announce the call with the intercom.
4. On the base, press **line 1** to talk.

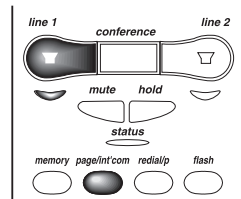

*If no one is available to take the call at the base, return to the caller by pressing **line 1** or **int'com** on the handset to take a message or complete the call.*

### ▼ From Base to Handset

1. To transfer a call on **line 1** from the base to the handset, press **hold**.

The **line 1** LED turns red.

2. On the base, press **page/int'com**.

The **status** LED flashes on the base.

The following screen appears:

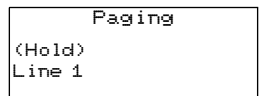
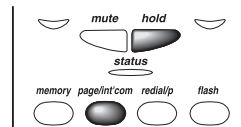

3. Answer at the handset by pressing **int'com**. You may then announce the call with the intercom.

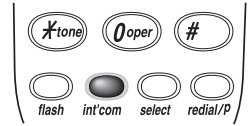

4. On the handset, press **line 1** to talk.

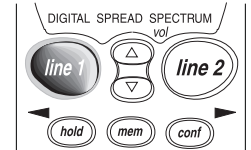

*If no one is available to take the call at the handset, return to the caller by pressing **line 1** or **page/int'com** on the base to take a message or complete the call.*

## TRAVELING OUT-OF-RANGE

As you begin to move too far from the base, you first hear a clicking sound. As you travel further, the noise increases. If you travel out-of-range, your call terminates.

## NOTE

Whenever you are using a menu screen, you must press a key within 20 seconds or the phone will return to standby.

## STORING A PHONE NUMBER IN MEMORY

Your EXS 9965 stores up to 30 name/numbers in the handset plus 10 numbers in the base. Memory locations are shared by both lines.

### ▼ On the Handset

1. Remove the handset from the base.
2. Press and hold **mem** for two seconds.

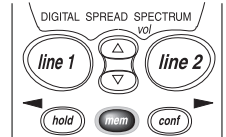

The following screen appears:

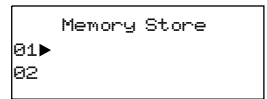

3. Use the ▲ and ▼ keys, or enter a two digit number (01-30) to choose the memory location to store a name/number.
4. Press **select**.

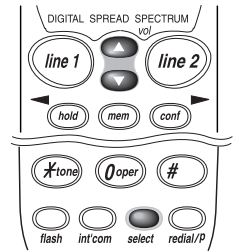

The following screen appears:

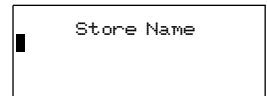

5. Enter a name by using the ▲ and ▼ keys to scroll through the character menu. Stop scrolling when you see the desired character. Use the ◀ and ▶ keys to move right or left or to create a blank space.

(The ◀ key deletes characters as the cursor moves left.)

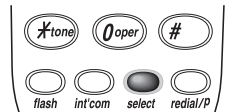

6. When you have finished entering a name, press **select**.

The following screen appears:

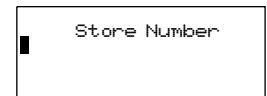

The cursor flashes indicating the display is ready for a number to be entered.

- Enter the phone number with the number keypad (direct entry). Use the ► key to position the cursor to right.



When entering numbers, you may press **redial/p** to enter a pause in the dialing sequence. The display shows a P. The pause feature is useful for long distance calling, credit card dialing, or any other dialing sequence requiring a pause between digits.

- When you have finished entering a name/number, press **select**.

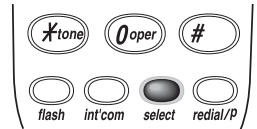

The handset beeps and displays a confirmation screen.

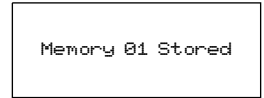

- The display then returns to the Memory Store screen. You may select another number to store a name/number (return to step 3) or press **mem** to return to standby.

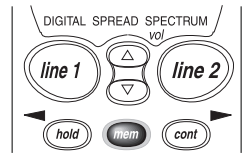

### ▼ On the Base

- Press **memory**. The **status** LED blinks.
- Dial the number you wish to store. (up to 16 digit)
- Press **memory**. Enter the memory location number (0-9) on the keypad. The status LED stops flashing. A confirmation beep indicates the number is stored.

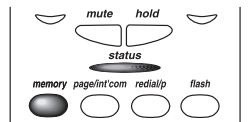
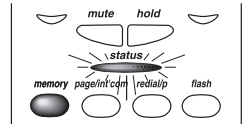

## EDITING A PHONE NUMBER IN MEMORY

To edit a number you have stored in the handset:

1. Remove the handset from the base.
2. Press and hold **mem** for two seconds.

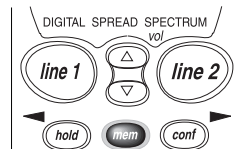

The display shows the Memory Store screen and any saved name/numbers.

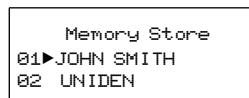

3. Use the ▲ and ▼ keys or enter a two-digit number (01-30) to select the memory location you would like to edit.
4. Press **select**.

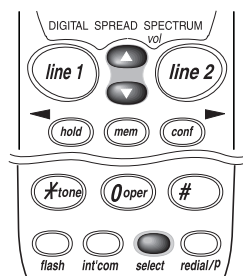

The display shows the memory location you have selected.

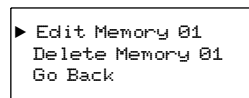

5. Press **select** again to enter the Edit Memory mode.

The following screen appears:  
A cursor flashes indicating that the display is ready to edit the name.

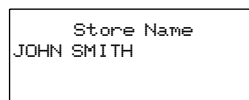

6. Edit the name with the ▲ and ▼ keys.  
Use the ▲ and ▼ keys to enter symbols.  
Use the ► key to move the cursor right.

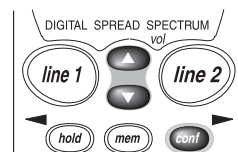

### NOTE

If you select **Go Back** at any time, no changes are made and the handset shows the Memory Store screen.

## NOTE

Whenever you are using a menu screen, you must press a key within 20 seconds or the phone will return to standby.

Press ◀ to erase up unwanted characters.

Press and hold ◀ to clear the entire name.

### 7. Press **select**.

The following screen appears:

A cursor flashes indicating that the display is ready for the number to be edited.

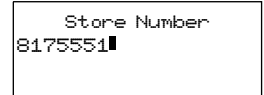
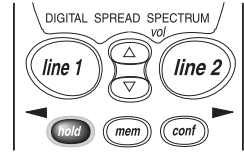

### 8. Enter the phone number with the number keypad.

Press ◀ to remove an unwanted number.

Press and hold ◀ to clear the entire number.

### 9. Press **select**.

The handset beeps and displays the confirmation screen.

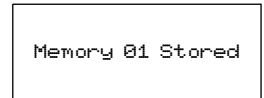

### 10. The display then returns to the Memory Store screen. You may select another number to edit (return to step 3) or press **mem** to return to standby.

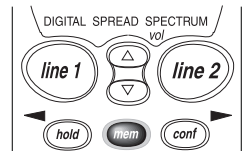



## ERASING A NUMBER FROM MEMORY

After erasing a number, you may add a new address to memory.

### ▼ From the Handset

1. Remove the handset from the base.
2. Press and hold **mem** for two seconds.

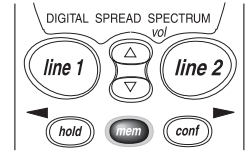

The handset shows the Memory Store screen with saved name/ numbers displayed.

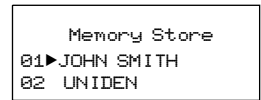

3. Use the ▲ and ▼ keys, or number keypad, to select the memory location you would like to delete. Use the ◀ and ▶ keys to display either the name or the number stored in the location.
4. Press **select**.

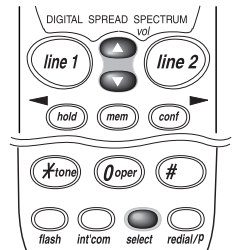

The following screen appears:

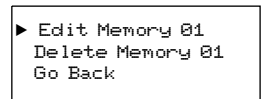

5. Use the ▼ key to move the ▶ cursor to **Delete Memory**.

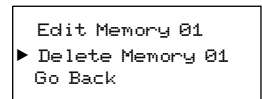

6. Press **select**.
7. Use the ▲ key to move the ▶ cursor to **Yes**.
8. Press **select**.

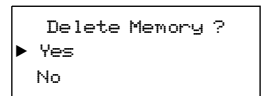

There is a confirmation tone.  
The following screen appears:

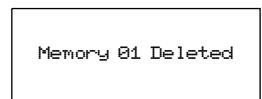

### NOTE

If you select **No**, no changes are made. The handset shows the Memory Store screen.

9. The display then returns to the Memory Store screen. You may select another number to delete (return to step 3) or you may press **mem** to return to standby.

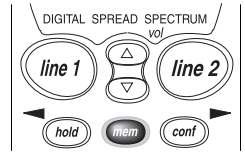

▼ *From the Base*

1. Press **memory**. The **status** LED blinks.

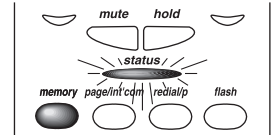

2. Press **memory** a second time. Enter the memory location (0-9) of the number you wish to delete. The **status** LED stops flashing. A confirmation beep indicates the number has been erased.

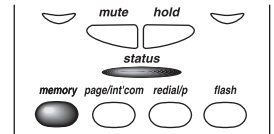

## USING MEMORY DIALING

Follow the steps below to dial a number using a programmed memory location.

### ▼ Standby mode Dialing from the Handset

1. Press **mem**.

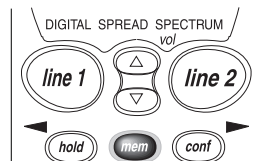

The handset displays your programmed memory locations.

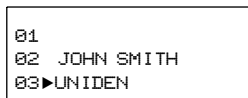

2. Use the ▲ and ▼ keys to select the memory location you would like to dial.

Or, you may enter a two-digit memory location number (01-30).

Use the ◀ and ▶ keys to display either the name or the number stored in the location.

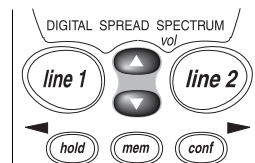

The following screen appears:

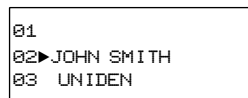

3. Press **line 1**. The number dials.

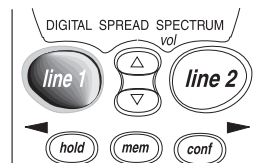

▼ *Talk mode Dialing from the Handset*

1. Press **line 1**.

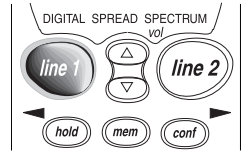

2. Press **mem**. Using the keypad, enter a two digit memory location number (01-30). The number dials.

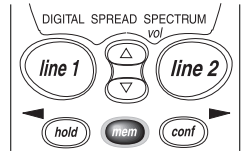

▼ *Dialing from the Base*

1. Press **line 1**. The **line 1** LED lights.

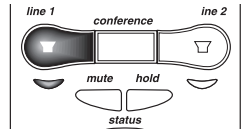

2. Press **memory**. Using the keypad, enter the memory location number (0-9). The number dials.

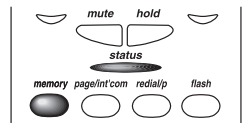

## QUICK REFERENCE CHART

If your phone is not performing to your expectations, please try these simple steps before calling Uniden customer service at **(800) 297-1023**.

PROBLEM	SUGGESTION
The <b>status</b> LED won't come on when the handset is placed in the base.	<ul style="list-style-type: none"> <li>● Make sure the AC adapter is plugged into the base and wall outlet.</li> <li>● Make sure the handset is properly seated in the base.</li> <li>● Make sure the charging contacts on the handset and base are clean.</li> </ul>
The audio sounds weak and/or scratchy.	<ul style="list-style-type: none"> <li>● Make sure that the base antenna is in a vertical position.</li> <li>● Move the handset and/or base to a different location away from metal objects or appliances and try again.</li> </ul>
Can't make or receive calls.	<ul style="list-style-type: none"> <li>● Check both ends of the base telephone line cord.</li> <li>● Make sure the AC adapter is plugged into the base and wall outlet.</li> <li>● Disconnect the AC adapter for a few minutes, then reconnect it.</li> <li>● Place the handset back on the charging cradle for a few seconds. The <b>status</b> LED blinks indicating that the phone has been reset.</li> </ul>
The handset doesn't ring or receive a page.	<ul style="list-style-type: none"> <li>● The Nickel-Cadmium battery pack may be weak. Charge the battery on the base for 15-20 hours.</li> <li>● Be sure the antenna is in a vertical position.</li> <li>● The handset may be too far away from the base. Place the base away from appliances or metal objects.</li> <li>● Place the handset back on the charging cradle for a few seconds. The <b>status</b> LED blinks indicating that the phone has been reset.</li> <li>● Make sure the ringer switch is on.</li> </ul>

# SPECIFICATIONS

## YOUR NEW PHONE

### GENERAL

The EXS 9965 complies with FCC Parts 15 and 68.

Frequency control:	PLL
Modulation:	Direct Sequence Spread Spectrum; DBPSK
Operating temperature:	0° to +50° C (+32° F to +122° F)

### BASE UNIT

Frequency:	904.2 to 925.8 MHz (20 channels)
Power requirements:	10V 500 mA (from AC adapter)
Size:	8-49/64 in. (W) x 6-57/64 in. (D) x 2-37/64 in. (H) (222.5 mm (W) x 175 mm (D) x 65.3 mm (H) )
Weight:	Approx. 23.6 oz. (Approx. 670g)

### HANDSET

Frequency:	904.2 to 925.8 MHz (20 channels)
Power requirements:	Rechargeable Nickel-Cadmium battery pack
Size (without antenna):	7 in. (W) x 2-17/64 in. (D) x 2 in. (H) (178 mm (W) x 57.6 mm (D) x 51 mm (H) )
Weight:	Approx. 8.8 oz. (250g) (including Battery)
Battery:	BT-999
Capacity	600 mAh, 3.6V
Talk mode	4 hours
Standby mode	7 days

*Specifications, features, and availability of optional accessories are all subject to change without prior notice.*

**At Uniden, we'll take care of you!**

If you need any assistance with this product, please call our Customer Hotline at

**1-800-297-1023**

**PLEASE DO NOT RETURN THIS PRODUCT TO THE PLACE OF PURCHASE.**

*Our Uniden representatives will be happy to help you with any matters regarding the operation of this unit, available accessories, or any other related matters.*

*Hours M-F 7:00 a.m. to 7:00 p.m. CST*

*Thank you for purchasing a Uniden product*

# THANK YOU

FOR PURCHASING A UNIDEN PHONE

## Uniden®

Covered by one or more of the following patents:

4,511,761	4,523,058	4,595,795	4,797,916	5,381,460
5,426,690	5,434,905	5,491,745	5,533,010	5,574,727
5,650,790	5,660,269	5,661,780	5,663,981	5,671,248
5,717,312	5,754,407	5,768,345	5,787,356	5,838,721

© 1999 Uniden America Corporation  
All rights reserved. • Printed in China • UCZZ01643BZ



## Free Manuals Download Website

<http://myh66.com>

<http://usermanuals.us>

<http://www.somanuals.com>

<http://www.4manuals.cc>

<http://www.manual-lib.com>

<http://www.404manual.com>

<http://www.luxmanual.com>

<http://aubethermostatmanual.com>

Golf course search by state

<http://golfingnear.com>

Email search by domain

<http://emailbydomain.com>

Auto manuals search

<http://auto.somanuals.com>

TV manuals search

<http://tv.somanuals.com>