



# OWNER'S MANUAL

EXT1160/EXT1165

900 MHz Extended Range

Caller ID

One Touch  
Voice Mail Access

Message Waiting  
Indicator

**Uniden**<sup>®</sup>

# Contents

## Welcome/Features

### Controls and Functions 2

### Getting Started

Read this First	4
Checking the Package Contents	5
Setting up the Phone	6
Mounting the Base Unit on a Wall	11

### Basics

Making and Receiving Calls	13
Terminology	14
Adjusting the Handset Ringer and Earpiece Volume	14
Redial	15
Tone Dialing Switch-over	15
Traveling Out-of-Range	15
Selecting a Different Channel	16
Page	16
Flash and Call Waiting	16
Using One Touch Voice Mail Access	17

## Memory Dialing

Storing Phone Numbers and Names	19
Making Calls with Memory Dialing	21
Chain Dialing	22
Editing a Stored Name and/or Phone Number	23
Erasing a Stored Name and Phone Number	25

## Caller ID Features

Caller ID	26
When the Telephone Rings	28
Viewing the Caller ID Message List	29
Deleting Information from the Caller ID List	30
Using the Caller ID List	32

## Additional Information

Changing the Digital Security Code	34
Installing the Beltclip	35
Headset Installation	35
Note on Power Sources	36
Maintenance	36
Troubleshooting	37
General Information	39
Technical Information	40
Index	42

# Welcome

Congratulations on your purchase of the Uniden EXT1160 (white) or EXT1165 (charcoal) cordless telephone. This phone is designed and engineered to exacting standards for reliability, long life, and outstanding performance.

**Note: Some illustrations in this manual may differ from the actual unit for explanation purpose.**

# Features

- 900 MHz Extended Range Technology
- Message Waiting Indicator
- One Touch Access to Voice Mail Box
- 3 Line Backlit Display
- Caller ID and Call Waiting Caller ID
- 10 Number Memory Dialing
- Face Up/Face Down Charging
- 32 Digit Redial
- Flash and Pause
- Bilingual Language Option
- Tone/Pulse Dialing
- Page/Find
- 7 Hour Talk Time/14 Day Standby Time
- Handset Earpiece and Ringer Volume Control
- Hearing Aid Compatible

The EXT1160/EXT1165 features include **AutoTalk™** and **AutoStandby™**. AutoTalk allows you to answer a call by just removing the handset from the base so you don't have to waste time pushing buttons or flipping switches. AutoStandby allows you to hang up by simply returning the handset to the base.

The **UltraClear Plus™** true compander circuitry virtually eliminates background noise. This innovative technology, together with 40 different channels, provides you with the best possible reception during all your conversations.

To protect you against misbilled calls which might result from your phone being activated by other equipment, the EXT1160/EXT1165 has **Random Code™** digital security which automatically selects one of over 65,000 digital security codes for the handset and base. Also, the **AutoSecure™** feature electronically locks your phone when the handset is in the base.

**Be sure to visit our web site: [www.uniden.com](http://www.uniden.com)**

Uniden® is a registered trademark of Uniden America Corporation.

AutoTalk, AutoStandby, UltraClear Plus, Random Code, and AutoSecure are trademarks of Uniden America Corporation.

# Controls and Functions

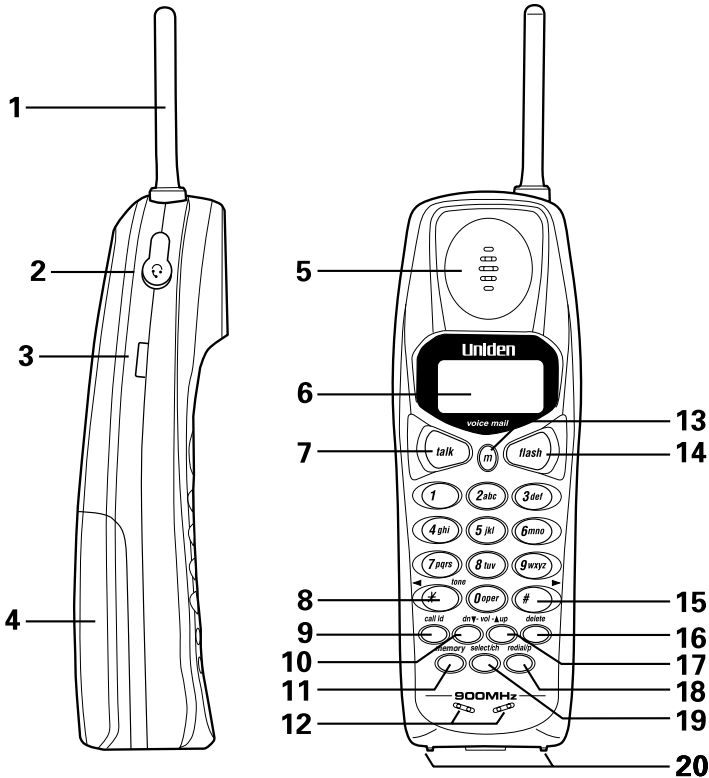

1. Handset antenna
2. Optional headset jack
3. Beltclip holes
4. Handset battery compartment
5. Handset earpiece
6. LCD display
7. Talk key
8. \*/left cursor (◀)/tone key
9. Caller ID key
10. Volume down ▼ key
11. Memory key
12. Handset microphone and ringer speaker
13. Voice mail key
14. Flash key
15. #/right cursor (▶) key
16. Delete key
17. Volume up ▲ key
18. Redial/pause (p) key
19. Select/channel (ch) key
20. Handset charging contacts

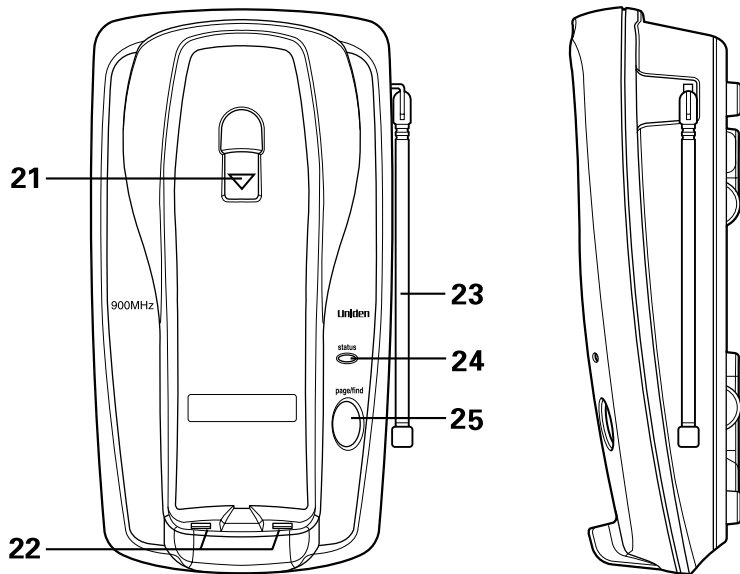

- 21. Handset retainer clip
- 22. Base charging contacts
- 23. Voice messages/status LED indicator
- 24. Page/find key
- 25. Base antenna
- 26. Tone/pulse switch
- 27. DC power input
- 28. Telephone line jack

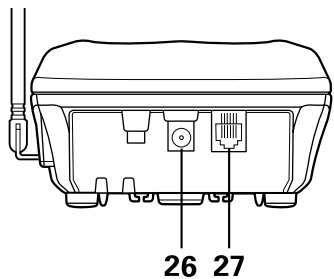

# Read this First

This cordless telephone must be set up before use. Follow these steps:

## Step 1 (page 5)

Unpack the telephone and accessories.

## Step 2 (page 6)

Next, choose the best location to set up the base unit.



## Step 3 (page 7 to 10)

Then, insert the battery pack into the handset. Connect the base unit. You must charge the battery pack for **15-20 hours before plugging into the telephone line and using the phone.**



## Step 4 (page 26 to 27)

Finally, set the Caller ID options and store your area code in the memory to use the Caller ID service.

**Note:** Skip the area code setting if your calling area requires 10-digit dialing.



## About the digital security code

This cordless telephone uses a digital security code to prevent unauthorized access to your base unit. This security code prevents other cordless handsets from making calls through your base unit.

A random security code will be assigned automatically between your base unit and handset when you charge the battery pack for the first time.

If you want to reset the security code, see page 34.

# Checking the Package Contents

Make sure you have received the following items in the package. If any of these items are missing or damaged, contact the Uniden Parts Department.



• Base unit

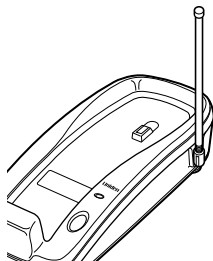

• AC adapter



• Rechargeable battery



• Handset

• Telephone cord

• Beltclip

## Also included:

- This Owner's Manual
- Other Printed Materials

Uniden Parts Department at (800) 554-3988  
Hours: M-F 7:00 a.m. to 5:00 p.m. CST. We can also be reached on the web at [www.uniden.com](http://www.uniden.com)

# Setting up the Phone

## Do the following steps:

- A. Choose the best location
- B. Install the battery pack
- C. Connect the base unit
- D. Choose the dialing mode

## A. Choose the best location

Before choosing a location for your new phone, read the INSTALLATION CONSIDERATIONS included in the PRECAUTIONS AND IMPORTANT SAFETY INSTRUCTIONS brochure. Here are some important guidelines you should consider:

**Avoid heat sources, such as radiators, air ducts, and sunlight**

**Avoid television sets and other electronic equipment**

**Choose a central location**

**Avoid noise sources such as a window by a street with heavy traffic**

**Avoid microwave ovens**

**Avoid excessive moisture, extremely low temperatures, dust, mechanical vibration, or shock**

**Avoid personal computers**

**Avoid other cordless telephones**

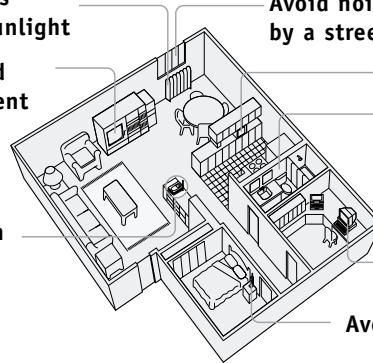

- The location should be close to both a phone jack and a continuous power outlet which is not switchable.
- Keep the base and handset away from sources of electrical noise such as motors, microwave ovens, and fluorescent lighting.
- Be sure there is sufficient space to raise the base antenna to a vertical position.
- The base can be placed on a desk, tabletop, or mounted on a standard wall plate.



## B. Install the battery pack

**Charge the battery pack for at least 15-20 hours before plugging the phone line into your phone.**

- 1) Press in on the battery cover release and slide the cover down until it comes off.
- 2) Connect the battery pack connector observing correct polarity (black and red wires) to the jack inside the battery compartment.

Do not exert any force on this connection. It could cause damage to the battery or to the handset. The plastic connectors will fit together in only one way. Once you are certain that you have made a good connection, then insert the battery pack into the battery compartment. Do not pinch the wires.

- 3) Securely close the battery compartment cover by sliding it up until it snaps into place.
- 4) Place the handset on the base. Remove the beltclip, if attached, for face up charging.

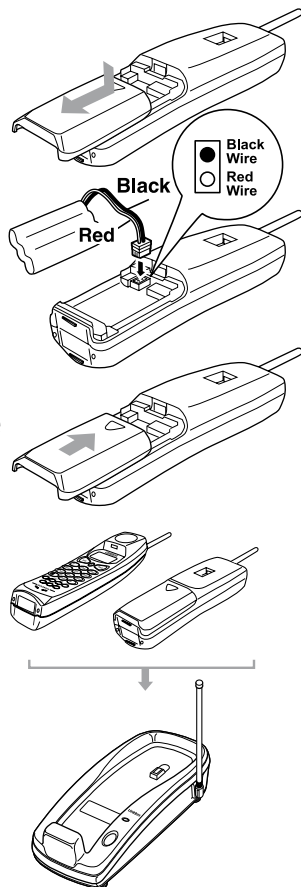

Use only the Uniden battery (BT-905) supplied with your phone. Replacement batteries are also available through the Uniden Parts Department. (See page 5.)



- Even when the battery pack is not being used, it will gradually discharge over a long period of time. For optimum performance, be sure to return the handset to the base unit after a telephone call.
- If you must replace the battery pack during a telephone call, complete the replacement of the battery pack within 30 seconds, and you can return to the original call.

## Battery use time (per charge)

From fully charged

- Seven hours continuous use
- Fourteen days when the handset is in the standby mode

## Low Battery Alert

When the battery pack is very low and needs to be charged, the phone is programmed to eliminate functions in order to save power. If the phone is not in use, "Low Battery" appears on the LCD and none of the keys will operate.

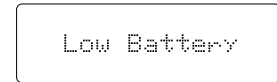

If the phone is in use, "Low Battery" flashes and the handset beeps. Complete your conversation as quickly as possible and return the handset to the base unit for charging.



The last number dialed in the redial memory, the names and the numbers stored in the memory locations are retained for up to 30 minutes while you replace the battery pack.

## Cleaning the Battery Charging Contacts

To maintain a good charge, it is important to clean the battery contacts on the handset and base unit with a dry cloth or a pencil eraser about once a month. Do not use any liquids or solvents.

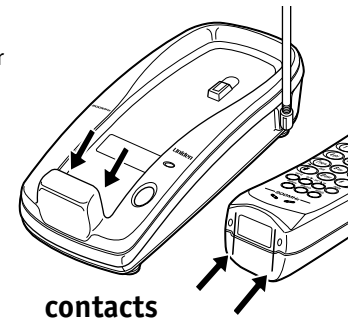

## C. Connect the base unit

1) Connect the AC adapter to the **DC IN 9V** jack and to a standard 120V AC wall outlet.

2) Set the base on a desk or tabletop, and place the handset on the base unit as shown. Remove the beltclip, if attached, for face up charging. (See "Mounting the Base Unit on a Wall", on page 11.)

3) Raise the antenna to a vertical position.

4) Make sure that the **voice messages/status** LED indicator lights. If the LED does not light, check to see that the AC adapter is plugged in and that the handset makes good contact with the base charging contacts.

note

- Use only the supplied AD-310 AC adapter. Do not use any other AC adapter.
- Connect the AC adapter to a continuous power supply.
- Place the base unit close to the AC outlet so that you can unplug the AC adapter easily.

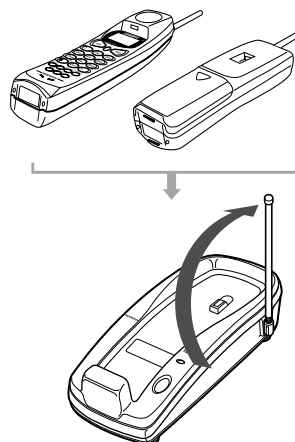
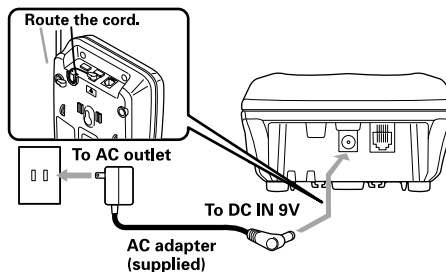

note

- The handset can be placed face up or face down in the base for charging.
- You have to remove the beltclip, if attached for face up charging.

!

Place the power cord so that it does not create a trip hazard or where it could become chafed and create a fire or electrical hazard.

- After installing the battery pack in the handset, charge your handset at least **15-20 hours before plugging into the phone line**. Once the handset battery pack is fully charged, connect the telephone line cord to the base and telephone wall outlet.

5) Connect the telephone line cord to the **TEL LINE** jack and to a telephone outlet once the handset is fully charged.



If your telephone outlet isn't modular, contact your telephone company for assistance.



Modular

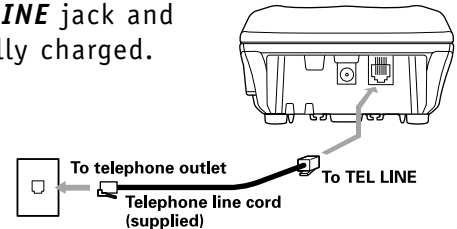

## D. Choose the dialing mode

Most phone systems use tone dialing which sends DTMF tones through the phone lines. However some phone systems still use pulse dialing such as in rural areas. The default setting is tone dialing. Depending on your dialing system, set the mode as follows:

If your dialing system is	Set the switch to
Tone	<b>TONE</b>
Pulse	<b>PULSE</b>

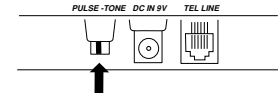

- If you are not sure of your dialing system, set for tone dialing. Make a trial call. If the call connects, leave the setting as is, otherwise set for pulse dialing.
- If your phone system requires pulse dialing and you need to send the DTMF tones for certain situations during a call, you may "switch-over" to tone dialing. (Refer to "Tone Dialing Switch-over" on page 15.)

# Mounting the Base Unit on a Wall

## Setting the handset retainer clip for wall mounting

- 1) On the base unit, pull the handset retainer clip out of the slot and rotate it clockwise 180 degrees.
- 2) Flip the retainer clip from front to back. Slide it back into the slot so that the lip of the retainer is up and the ▼ is down. The retainer holds the handset in place.

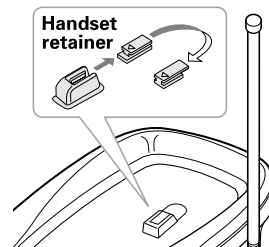

## Standard wall plate mounting

This phone can be mounted on any standard wall plate.

- 1) Plug the AC adapter into the **DC IN 9V** jack.
- 2) Wrap the AC adapter cord inside the molded wiring channel as shown.
- 3) Plug the AC adapter into a standard 120V AC wall outlet.
- 4) Place the handset on the base unit and charge for 15-20 hours.
- 5) Plug the telephone line cord into the **TEL LINE** jack. Wrap the cord inside the molded wiring channel as shown.

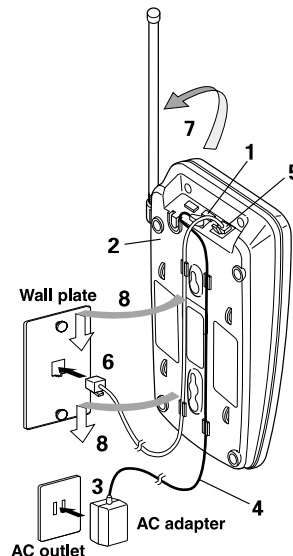

DO NOT use an outlet controlled by a wall switch.



If you have wall mounted the base, you have to remove the belt clip to hang the handset with the display facing forward.

- 6) Plug the telephone line cord into the telephone outlet.
- 7) Raise the antenna to a vertical position.
- 8) Align the mounting slots on the base with the mounting posts on the wall. Then push in and down until the phone is firmly seated.

### Direct wall mounting

If you don't have a standard wall plate, you can mount your phone directly to the wall. Before doing this, consider the following:

- Avoid electrical cables, pipes, or other items behind the mounting location that could cause a hazard when inserting screws into the wall.
- Try to mount your phone within 5 feet of a working phone jack to avoid excessive lengths.
- Make sure the wall material is capable of supporting the weight of the base and handset.
- Use #10 screws (minimum length of 1-3/8 inches) with anchoring devices suitable for the wall material where the base unit will be placed.

1) Insert two mounting screws into the wall, (with their appropriate anchoring device), 3-15/16 inches apart. Allow about 1/8 of an inch between the wall and screw heads for mounting the phone.

2) Set the retainer clip if necessary.

3) Refer to steps 1 through 8 on pages 11 and 12 to mount the telephone.

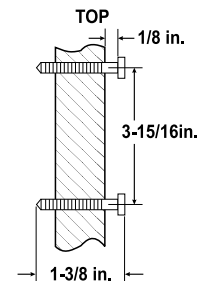

# Making and Receiving Calls

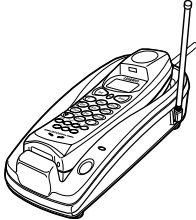
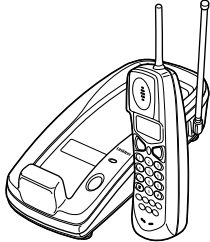
	Handset On Base	Handset Off Base
		
To answer a call	Pick up the handset (AutoTalk) or press <b>talk</b> .	Press any key (When the AutoTalk is set to on) or press <b>talk</b> .
To make a call	1) Pick up the handset. 2) Press <b>talk</b> . 3) Listen for the dial tone. 4) Dial the number. <p style="text-align: center;"><b>OR</b></p> 1) Pick up the handset. 2) Dial the number, then press <b>talk</b> .	1) Press <b>talk</b> . 2) Listen for the dial tone. 3) Dial the number. <p style="text-align: center;"><b>OR</b></p> Dial the number, then press <b>talk</b> .
To hang up	Press <b>talk</b> , or return the handset to the base (AutoStandby).	Press <b>talk</b> .
To redial	1) Pick up the handset. 2) Press <b>talk</b> . 3) Listen for the dial tone. 4) Press <b>redial/p</b> .	1) Press <b>talk</b> . 2) Listen for the dial tone. 3) Press <b>redial/p</b> .



Refer to page 26 "Setting Caller ID Options" to turn on Auto Talk feature if desired.

## Terminology

Throughout this manual, terms such as Standby and Talk Mode are used. Below is the terminology explanation.

- **Standby Mode** - The handset is not in use, off the base, and *talk* has not been pressed. A dial tone is not present.
- **Talk Mode** - The handset is off the base and *talk* has been pressed enabling a dial tone.

## Adjusting the Handset Ringer and Earpiece Volume

### Ringer tone and volume

When the phone is in standby mode, pressing the *vol* ▼ or ▲ key on the handset selects the handset ringer volume and tone. There are two ringer tones each with two volume levels. Continue pressing the *vol* ▼ or ▲ key to listen to all tones and volume levels. The phone keeps the last ringer tone and volume setting selected.

### Earpiece volume

The handset earpiece volume settings (Low, Medium, High and Loud) can only be adjusted during a call. Press *vol* ▼ or ▲ to select Low, Medium, High and Loud. When you hang up, the phone keeps the last volume setting selected.

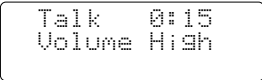

Talk 0:15  
Volume High



# Redial

The **redial/p** key redials the last number dialed. The redialed number can be up to 32 digits long.

# Tone Dialing Switch-over

Some telephone companies use equipment that require pulse dialing (sometimes referred to as rotary dialing). If you need to enter tone dialing digits, you can switch-over to tone dialing during the call. An example of this could be entering your bank account number after you have called your bank. The digits of your bank account can be sent using DTMF tones.

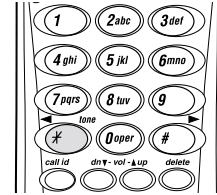

Initially make your call with the pulse dialing mode. Once your call connects, press **\*/tone** ◀. Enter the desired number (like in example above: the bank account number). These digits will be sent as tone dialing. This special number can be stored in a memory location. This is referred to as Chain Dialing (See page 22.) Once the call ends, the tone mode is canceled and pulse dialing mode resumes.

# Traveling Out-of-Range

During a call, as you begin to move your handset too far from your base unit, noise increases. If you pass the range limits of the base unit, your call will terminate within 20 seconds.



The tone feature only applies when the dial mode is set to pulse.

## Selecting a Different Channel

If you encounter interference while using your phone, you can manually change the phone's channel for clear operation. Interference can come from appliances or other phones in your home. This function works only when the phone is in use.

During the course of a conversation, if you hear static or noise which makes it difficult to hear, press **select/ch**. "Scanning" appears on the display, indicating the phone is changing to another channel. For more information on interference, refer to "Technical Information" on page 40.



If you press **talk** during paging, the handset will be placed in the talk mode.

## Page

To locate the handset (while it's off the base), press **page/find** on the base. The handset beeps for 60 seconds.

Paging is canceled when pressing any key or the handset is returned to the base.

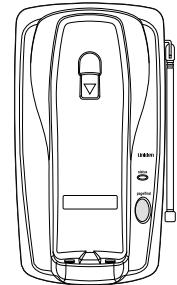

## Flash and Call Waiting



If you have "Call Waiting" service and a call waiting tone sounds while you are on a call, press **flash** to accept the waiting call. There is a short pause, then you will hear the new caller. To return to the original caller, press **flash** again.



You must subscribe through your local telephone company to receive Call Waiting Service.

# Using One Touch Voice Mail Access

If you subscribe to voice mail service, you can use your EXT1160/EXT1165 to access your voice mailbox. The messages light on the base of your phone flashes whenever you have messages waiting in your voice mailbox. Just program the **m** key with your access number and you can get your messages at the touch of a button. (The voice mail service provider will supply you with the access number. This number may be simply a phone number. Refer to the provider's literature.)

## Programming your Voice Mail Access Number

1) On the handset, press and hold **m** for about 2 seconds. The following screen appears:

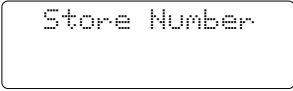

Store Number

If you have previously stored a number, the following display appears: Use the ▲ and ▼ to move the pointer to the Edit Number option. Press **select/ch** to select the option.



▶ Edit Number  
Delete Number  
Go Back

2) Enter your personal access number.

3) Press **select/ch**. You will hear a confirmation tone and the following display appears:

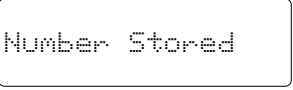

Number Stored



You must subscribe to voice mail service from your telephone company in order to use this feature. The voice mail service company will provide you with the access number.

## Dialing your Voice Mail Service

Once you've programmed your personal access number, you can dial your mailbox with a touch of a button. When you have messages, simply pick up the handset and press **m**. Or press **talk**, listen for the dial tone, and then press **m**. If you have not entered the access number or it has been deleted, when you press **m**, an error tone sounds.

## Message Waiting Indicator

The **voice messages/status** LED indicator on the base is designed to work with voice mail service provided by your local telephone company. The indicator flashes when you have new voice messages.

You may need to occasionally reset the indicator if it remains on after you retrieved your messages. To reset the indicator, press and hold **page/find** for 5 seconds or until the indicator stops flashing.

# Storing Phone Numbers and Names

Memory Dialing allows you to dial a number using just a few key strokes. Your EXT1160/EXT1165 stores up to 10 names/numbers in the handset.

- 1) Press and hold **memory** until "Memory Store" is displayed.
- 2) Press ▲ and ▼ or enter a number (0 - 9) to select the memory location where you would like to store the number.
- 3) Press **select/ch**. The following screen appears and a cursor flashes indicating that the display is ready for the name to be entered.

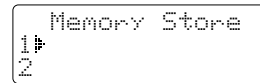

```
Memory Store
1
2
```

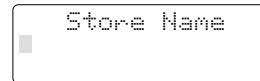

```
Store Name
█
```

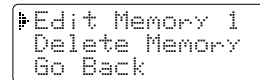

```
Edit Memory 1
Delete Memory 1
Go Back
```

If this screen appears, the selected memory location is already stored. Then you must either change the entry in this location, clear the entry in this location, or select "Go Back" to choose another location.

- 4) To enter a name (up to 14 characters), use the number keys.
  - Use the ▲ and ▼ keys to scroll through the character menu.
  - Use # ► and \*/tone ◀ to move the cursor to the desired location.
  - Use **delete** to delete characters as needed.
  - Press and hold **delete** to delete all the characters.
  - If a name is not required, go to step 5.



In memory dialing operation, you must press a key within 20 seconds or the phone will return to standby. If you return the handset to the base, the phone will return to standby also.



- You have 20 seconds after pressing **memory** to enter the number you wish to store. Otherwise, an error tone will sound.
- The pause feature is useful for long distance calling, credit card dialing, or sequences that require a pause between digits.

5) Press **select/ch**. "Store Number" is displayed.  
The cursor flashes indicating that the display is ready for the number to be entered.

```
Store Number
█
```

6) Use the number keys to enter the phone number.  
The phone number cannot exceed 16 digits.  
Use **redial/p** to enter pause in the dialing sequence.  
The display shows a "P". Each pause counts as one digit and represents a two second delay of time between the digits.  
Use **delete** to delete digits as needed.

```
Store Number
8002971023█
```

7) Press **select/ch**. The handset beeps and displays the confirmation screen. Memory storage is complete.  
For example, if you store a name and number into memory location number 7, the display shows "Memory 7 Stored".  
After about 2 seconds, "Memory Store" is displayed.  
Repeat steps 2 - 7 to store more numbers.

```
Memory 7 Stored
```

8) Press **memory** to return to standby mode.

```
Memory Store
7▶UNIDEN CORP
8 <Memory 8>
```

# Making Calls with Memory Dialing

## Memory dialing from Standby Mode

1) Press **memory**.

The handset displays your programmed memory locations.

```
1▶ UNIDEN CORP
2 JOHN DOE
3 MOM AND DAD
```

2) Press ▼ and ▲ or enter the number (0 - 9) to select the memory location you would like to dial.

```
<Talk>
0123456789012
```

3) Press **talk**. "Talk" and the volume setting appear on the display. Then the displayed number is dialed.

## Display a Programmed Number

Use #▶ and \*/tone◀ to toggle between the names display and the numbers display.

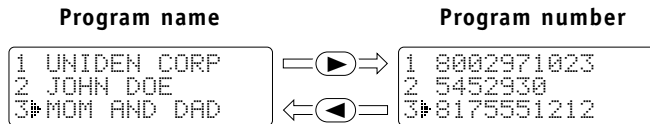

- If you press **select/ch** before **talk**, you can confirm the name and the number stored in the selected memory location.
- To exit the memory function without dialing, press **memory**. The handset returns to standby.
- Whenever you are using a menu screen, you must press a key within 20 seconds or the phone will return to standby.

## Memory dialing from Talk Mode

1) Press **talk**. "Talk" and the volume setting appears.

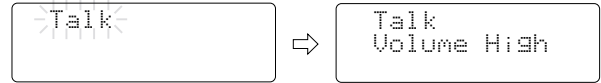

2) Press **memory**.

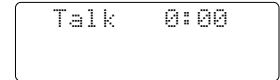

3) Enter a number (0 - 9) to select the memory location of the desired phone number. The selected phone number is displayed. Then the number is dialed.



4) To hang up, press **talk**.

## Chain Dialing

The 10 memory locations on the handset are not limited to phone numbers. You may want to store in memory a group of numbers (up to 16 digits) that you need to enter once your call connects. This is referred to as Chain Dialing.

An example of this is a bank account number. Once you have called your bank, when you are prompted to enter the account number, simply press **memory** and then the location where the special number has been stored.

Store your special number with identifying name in memory as you would a phone number. (Refer to "Storing Phone Numbers and Names" on page 19.) Enter a pause as necessary in the sequence.

A pause counts as one digit and represents a two second delay in time between digits as they are sent.



# Editing a Stored Name and/or Phone Number

- 1) Press and hold **memory** until "Memory Store" is displayed.

```
Memory Store
1 UNIDEN CORP
2 JOHN DOE
```

- 2) Press ▲ and ▼ or enter a number (0 - 9) to select the memory location you would like to edit.

- 3) Press **select/ch**.

The following screen appears with the memory location number that you have selected in the display.

```
Edit Memory 2
Delete Memory 2
Go Back
```

- 4) Press ▲ or ▼ to select "Edit Memory", then press **select/ch**.

The following screen appears. The cursor flashes indicating that the display is ready for the name to be edited. When a name has not been stored, the cursor appears at the beginning of the second line.

```
Store Name
UNIDEN CORP
```

- 5) Use the ▲ or ▼ keys, **\*/tone**◀, **#**▶, or **delete** to edit the name. (See page 19.)  
To edit only the phone number, skip this step.

- 6) Press **select/ch**. The following screen appears.

The cursor flashes indicating that the display is ready for the number to be edited.

```
Store Number
8002971023
```

- 7) Use the number keys, **redial/p**, **\*/tone**◀, **#**▶, or **delete** to edit the phone number.

The phone number cannot exceed 16 digits. (See page 20.)

If you don't want to change the phone number, skip this step.

8) Press ***select/ch***. The handset beeps and displays the confirmation screen. The memory storage is complete. For example, if you store a name and number into memory location number 1, the display shows "Memory 1 Stored". After about 2 seconds, "Memory Store" is displayed.



Memory 1 Stored

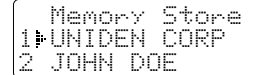

Memory Store  
1 UNIDEN CORP  
2 JOHN DOE

9) Press ***memory*** to return to standby mode.

# Erasing a Stored Name and Phone Number

- 1) Press and hold **memory** until "Memory Store" is displayed.
- 2) Press ▲ and ▼ or enter a number (0 - 9) to select the memory location you would like to edit.
- 3) Press **select/ch**.  
The following screen appears with the memory location number that you have selected in the display.
- 4) Press ▼ to move the pointer down to "Delete Memory".
- 5) Press **select/ch**. The following confirmation screen appears.
- 6) Press ▲ to move the pointer to "Yes".
- 7) Press **select/ch** or **delete**.  
The following screen appears.
- 8) After a few seconds the display returns to the "Memory Store" screen.  
You may delete the information in another memory location (return to step 2) or press **memory** to return to standby.

```
Memory Store
1▶UNIDEN CORP
2 JOHN DOE
```

```
Memory Store
1▶UNIDEN CORP
2 JOHN DOE
```

```
▶Edit Memory 2
Delete Memory 2
Go Back
```

```
Edit Memory 2
▶Delete Memory 2
Go Back
```

```
Delete Memory 2?
Yes
▶No
```

```
Memory 2 Deleted
```

```
Memory Store
2▶
3 MOM AND DAD
```



You must subscribe to Caller ID on Call Waiting in order to use this feature.

The Call Waiting options are a separate service available through your phone company.

If your calling area requires 10-digit dialing, do not program this option.

## Caller ID

**You must subscribe to Caller ID service to use this feature.**

When the telephone rings, the Caller ID feature allows you to view the caller's name and phone number on the display before you answer the phone.

The handset displays the phone number of the incoming call, the name, time, and the number of calls. Additionally, you can dial the displayed number and store the information for memory dialing.

### Setting Caller ID options/Language

There are three Caller ID setup options available: AutoTalk, CIDCW (Caller ID on Call Waiting) and Area Code.

**AutoTalk** allows you to answer the phone without pressing **talk**. If the phone rings when AutoTalk is on, simply remove the handset from the base and the phone automatically answers the call. Or, if the handset is not on the base, press any key to answer the call. If the phone rings when AutoTalk is off, you must press **talk** to answer the call.

**Caller ID on Call Waiting (CIDCW)** performs the same as regular Caller ID on a call waiting number.

If you enter a 3-digit area code number in the **Area Code** option, your local area code does not appear in Caller ID messages. When reviewing or receiving Caller ID messages, you will see only the local 7-digit number. For calls received from outside your local area code, you will see a full 10-digit number.

**Language** option can be used to choose the language of your display. You can select either English or French.

## To change your Caller ID options/Language:

- 1) When the phone is in standby mode, press and hold **call id**.  
The following screen appears.

```

1▶ Auto Talk: Off
2 CIDCW      :On
3 Area Code:
  
```

- 2) Use ▲, ▼, or a number key (1-4) to move the pointer to the selection that you would like to change.

Press **select/ch** to toggle between "On" and "Off" for "Auto Talk".  
For "CIDCW", choose "On", "Off", or "Opt", depending upon the type of service to which you subscribe.

- 3) When you wish to enter the Area Code, press ▼ or the number key 3 to move the pointer to "Area Code". Then press **select/ch** and enter the 3 digit area code by using the number keypad (0 - 9). After entering the area code, press **select/ch**.

- 4) To set up the language of your display, press ▼ or the number key 4 to move the pointer to "Language".  
Press **select/ch** to select "Eng"(English) or "Fr."(French).

```

2 CIDCW      :On
3 Area Code:
4▶ Language :Eng
  
```

- 5) After you have made your selections, press **call id** and return the handset to the base.



- If you answer a call before the Caller ID message is received (Example: before the second ring), the Caller ID message will not appear.
- When the call is received via a telephone company that does not offer Caller ID service, the caller's phone number and name do not appear. (This includes international calls.)
- When the call is via a private branch exchange (PBX), the caller's phone number and name may not appear.

## When the Telephone Rings

- 1) When the Caller ID message is received, the display shows the caller's phone number along with the date and time. The incoming call information is stored in the Caller ID record. If the Caller ID service includes the caller's name, the caller's name appears on the display (up to 15 letters).

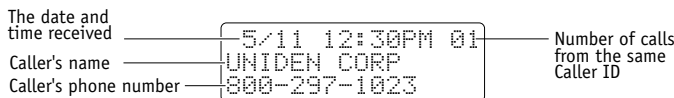

Here are some typical displays;

### When the phone number and name data are received

```
5/11 12:30PM 01
UNIDEN CORP
800-297-1023
```

### When invalid data is received

```
Incomplete Data
```

### When a private name is received

```
5/11 12:30PM 01
Private Name
800-297-1023
```

### When a private number is received

```
5/11 12:30PM 01
UNIDEN CORP
Private Number
```

### When an unknown name is received

```
5/11 12:30PM 01
Unknown Name
800-297-1023
```

### When an unknown number is received

```
5/11 12:30PM 01
UNIDEN CORP
Unknown Number
```

- 2) When you pick up the phone, the display changes to "Talk". (AutoTalk feature is set to on.)



Data errors appear as "■".

## Viewing the Caller ID Message List

The Caller ID list stores information for up to 30 incoming calls - even unanswered calls.

1) Press **call id**.

The summary screen appears.

The screen shows the number of new messages and total messages.

```
New :01
Total:02
```

2) Press ▼ to display the latest Caller ID message.

```
5/17 12:30PM 03
UNIDEN CORP
800-297-1023
```

3) Press ▼ to see the next message. Or press ▲ to see the previous message.

4) Press **call id** to return to standby.



- In Caller ID operation, if no key is pressed for more than 20 seconds, an error tone sounds and the telephone returns to the standby mode.
- If a call comes in via a telephone system that does not offer Caller ID service, no information is stored.
- Each message can be up to 15 characters for the phone number and the name.



- While using the "Delete All?" or "Delete Message?" screen if no key is pressed for more than 20 seconds, an error tone sounds and the telephone returns to standby.
- If you get an incoming call or page, the deleting operation is canceled and the telephone returns to standby so you can answer the call or page.

## Deleting Information from the Caller ID List

The EXT1160/EXT1165 stores up to 30 messages. If the phone receives the 31st message, the oldest one in the list is automatically deleted. Caller ID data can also be deleted manually.

### Deleting a Caller ID message

- 1) Press **call id**. Display the message to be deleted from the Caller ID list by pressing ▲ or ▼.
- 2) Press **delete**.
- 3) Press ▲ or ▼ to select "Yes" or "No".
- 4) Press **select/ch** or **delete**.

```
5/17 12:30PM 03
UNIDEN CORP
800-297-1023
```

```
Delete Message?
#Yes
No
```

**When the pointer is at "Yes":**

A tone sounds and the Caller ID message is deleted. The next Caller ID message is then displayed.

**When the pointer is at "No":**

The display returns to the Caller ID message.

### Deleting all Caller ID names/numbers

- 1) Press **call id**.
- 2) Press **delete**.

```
New :01
Total:02
```

```
Delete All?
Yes
#No
```



3) Press ▲ or ▼ to select "Yes" or "No".

4) Press *select/ch* or *delete*.

**When the pointer is at "Yes":**

A tone sounds and all stored Caller ID messages are deleted.

**When the pointer is at "No":**

The display returns to the summary screen.

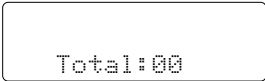

Total:00



New :01  
Total:02



- You cannot make a call from the Caller ID list if your EXT1160/EXT1165 is connected to private branch exchange (PBX).
- When a long distance call has been set, "1" appears in the display.

## Using the Caller ID List

### Calling a party from the Caller ID list

You can place a call from the Caller ID list. The EXT1160/EXT1165 stores up to 30 messages.

- 1) Press **call id**. Select the phone number that you want to dial by pressing ▲ or ▼.
- 2) Press **talk**. The displayed phone number dials automatically.

```
5/17 12:30PM 03
UNIDEN CORP
800-297-1023
```

### Long Distance calls

Pressing **1** while the incoming Caller ID information is displayed (in step 1) will place the prefix "1" in the display to set up for a long distance call.

```
Talk
8002971023
```

### Dial edit

You can temporarily edit the Caller ID number that is displayed by pressing **select/ch**.

A cursor appears in the display. Press **delete** to move the cursor left, make your changes and then press **talk**. This will not change the number in the Caller ID list memory.

If you want to save this new number, store the information in memory.  
(See page 19.)

## Storing Caller ID messages in Memory dialing

Messages shown in the Caller ID list can be stored in memory dialing. Using the incoming call information (i.e., Caller ID list), the phone number of the party on the Caller ID list can be stored in memory.

1) Press **call id**.

Select the phone number to be stored from the Caller ID list by pressing ▲ or ▼.

```
5/17 12:30PM 03
UNIDEN CORP
800-297-1023
```

2) Press **memory**.

```
Select Location
1 UNIDEN CORP
2 JONE DOE
```

3) Press ▲ and ▼ or enter a number (0 - 9) to select the memory location to be stored.

4) Press **select/ch**.

The number is stored in memory, and the display returns to the Caller ID list.

```
5/17 12:30PM 03
UNIDEN CORP
800-297-1023
```



If a message has already been stored in the selected memory number location, a confirmation screen is displayed. Press ▲ to select "Yes". Press **select/ch** to overwrite. The display returns to the Caller ID list.

```
Replace Memory?
Yes
▶ No
```



You can not store a Caller ID message if no phone number appears in the message.



If the handset battery pack is completely discharged or the battery pack is removed, the digital security code will be lost. If this happens, a new security code is set automatically next time the battery pack is charged.

## Changing the Digital Security Code

The digital security code is an identification code used to connect the handset and the base unit. Normally, setting the code is not necessary.

The first time you charge your handset, the security code is automatically set. (See "About the digital security code", page 4.)

In the rare situation that you suspect another cordless telephone is using the same security code, you can change the code.

- 1) Place the handset in the base unit. Press **page/find** on the base.
- 2) The handset begins emitting a paging sound. While holding **page/find** for at least 3 seconds, place the handset on the base unit. The paging sound stops. Leave the handset on the base for more than 5 seconds or until the **voice messages/status** LED indicator stops flashing. A new random security code is set.

## Installing the Beltclip

### To attach the beltclip

Insert the beltclip into the holes on each side of the handset. Press down until it clicks.

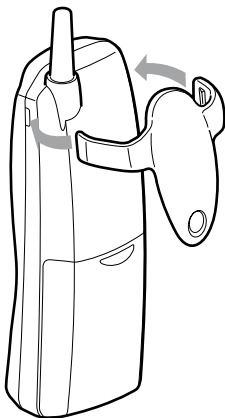

### To remove the beltclip

Pull both sides of the beltclip to release the tabs from the holes.

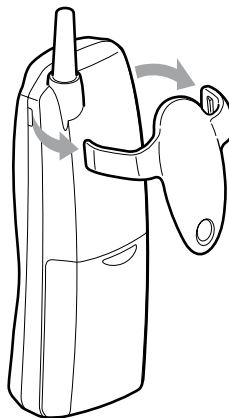

If the beltclip is attached, you can only charge the handset in the face down position.

## Headset Installation

Your phone may be used with an optional headset, the Uniden HS910. To use this feature, insert headset plug into the headset jack. Your phone is ready for hands-free conversations. (Headset may be purchased by calling the Uniden Parts Department or visiting the web site. See Page 5.)

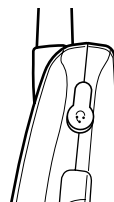

# Note on Power Sources

## Battery replacement and handling

When the operating time becomes short, even after a battery is recharged, please replace the battery.

With normal usage, your battery should last about one year. Please contact your place of purchase or the Uniden Parts Department for a replacement battery.

### Power Failure

During the period that the power is off, you will not be able to make or receive calls with the telephone.

### Caution

- Use the specified battery pack.
- Do not remove the battery from the handset to charge it.
- Never throw the battery into a fire, disassemble it, or heat it.
- Do not remove or damage the battery casing.

# Maintenance

## When slightly dirty

Wipe with a soft, dry cloth.

## When very dirty

Wipe with a soft cloth that has been dampened with diluted, neutral detergent. Dry with a dry cloth.

## When the charging terminals become dirty

Wipe with a dry cloth or a pencil eraser, if necessary.

## RECYCLING NICKEL-CADMIUM BATTERIES



**NICKEL-CADMIUM  
BATTERIES MUST BE  
DISPOSED OF PROPERLY.**

Nickel-cadmium cells are used in the battery pack. Please take your used nickel-cadmium battery packs to a store that recycles nickel-cadmium batteries.

### Caution

Do not use paint thinner, benzene, alcohol, or other chemical products. Doing so may discolor the surface of the telephone and damage the finish.

# Troubleshooting

If your phone is not performing to your expectations, please try these simple steps first.

Symptom	Suggestion
The <b>voice messages/status</b> LED indicator won't light when the handset is placed in the base.	<ul style="list-style-type: none"><li>• Make sure the AC adapter is plugged into the base and wall outlet.</li><li>• Make sure the handset is properly seated in base.</li><li>• Make sure the charging contacts on the handset and base are clean.</li></ul>
The audio sounds weak and/or scratchy.	<ul style="list-style-type: none"><li>• Make sure that the base antenna is in a vertical position.</li><li>• Move the handset and/or base to a different location away from metal objects or appliances and try again.</li><li>• Press <b>select/ch</b> to help eliminate background noise.</li></ul>
Can't make or receive calls.	<ul style="list-style-type: none"><li>• Make sure that you are not too far from the base.</li><li>• Check both ends of the base telephone line cord.</li><li>• Make sure the AC adapter is plugged into the base and wall outlet.</li><li>• Disconnect the AC adapter for a few minutes, then reconnect it.</li><li>• Reset the digital security code (See page 34).</li></ul>

<b>Symptom</b>	<b>Suggestion</b>
The handset doesn't ring or receive a page.	<ul style="list-style-type: none"> <li>• The battery pack may be weak. Charge the battery on the base unit for 15-20 hours.</li> <li>• The handset may be too far away from the base unit.</li> <li>• Place the base unit away from appliances or metal objects.</li> <li>• Reset the digital security code (See page 34).</li> </ul>
Severe noise interference.	<ul style="list-style-type: none"> <li>• Keep the handset away from microwave ovens, computers, remote control toys, wireless microphones, alarm systems, intercoms, room monitors, fluorescent lights, and electrical appliances.</li> <li>• Move to another location or turn off the source of interference.</li> </ul>
The Caller ID does not display.	<ul style="list-style-type: none"> <li>• The handset was picked up before the second ring.</li> <li>• The call was placed through a switchboard.</li> <li>• Call your local telephone company to verify your Caller ID service is current.</li> <li>• Charge the handset.</li> </ul>
If you still have a problem	<ul style="list-style-type: none"> <li>• Call our customer hotline at 1-800-297-1023.</li> </ul>



# General Information

The phone complies with FCC Parts 15 and 68.

Operating temperature: -10° to 50°C (+14°F to +122°F)

## AC Adapter Information

AC Adapter part number: AD-310  
Input Voltage: 120V AC 60Hz  
Output Voltage: 9V DC 210 mA

## Battery Information

Battery part number: BT-905  
Capacity: 600 mAH, 3.6V  
Battery use time (per charge)  
From fully charged -  
Talk mode duration: 7 hours  
Standby mode duration: 14 days



If the handset is left off of the base, the actual Talk mode duration will be reduced respective to the amount of time the handset is off the base.

Recharge your phone on a regular basis by returning the handset to the base after each phone call. When the operating time becomes short, even after the battery is recharged, please replace the battery. With normal usage, the battery should last about one year.

Replacement batteries may be purchased at your local Uniden dealer or by contacting the Uniden Parts Department (800) 554-3988. Hours are from 7:00 a.m. to 5:00 p.m. Central Time, Monday through Friday. We can also be reached on the web at [www.uniden.com](http://www.uniden.com)

Specifications, features, and availability of optional accessories are all subject to change without prior notice.

# Technical Information

## **The FCC wants you to know!**

Changes or modifications to this product not expressly approved by Uniden, or operation of this product in any way other than as detailed by the owner's manual, could void your authority to operate this product. The equipment cannot be used on public coin phone service provided by the telephone company. Connection to party line service is subject to state tariffs. (Contact the state public utility commission, public service commission or corporation commission for information.)

Below is some information that might concern you while using your new phone.

## **Range**

Your new phone is designed to achieve the maximum possible range by transmitting and receiving according to the highest specifications set forth by the FCC. We have rated this phone to operate at a maximum distance with the qualification that the range depends upon the environment in which the telephone is used. Many factors limit range, and it would be impossible to include all the variables in our rating. The Maximum Range rating of this phone is meant to be used as a means of comparison against other range claims.

## **Telephone Line Problems**

The FCC has granted the telephone company the right to disconnect service in the event that your phone causes problems on the telephone line. Also, the telephone company may make changes in facilities and services which may affect the operation of your unit. However, your telephone company must give adequate notice in writing prior to such actions to allow you time for making necessary arrangements to continue uninterrupted service.

If you are having trouble with your telephone service, you must first disconnect your phone to determine if it is the cause of your problem. If you determine that it is the cause, you must leave it disconnected until the trouble has been corrected.

## **Radio Interference**

Radio interference may occasionally cause buzzing and humming in your cordless handset, or clicking noises in the base. This interference is caused by external sources such as TV, refrigerator, vacuum cleaner, fluorescent lighting, or electrical storm. Your unit is NOT DEFECTIVE. If these noises continue and are too distracting, please check around your home to see what appliances may be causing the problem.

In addition, we recommend that the base not be plugged into a circuit that also powers a major appliance because of the potential for interference. Be certain that the antenna on the unit is fully extended when needed.

In the unlikely event that you consistently hear other voices or distracting transmissions on your phone, you may be receiving radio signals from another cordless telephone or other source of interference. If you cannot eliminate this type of interference, you need to change to a different channel.

Finally, it should be noted that some cordless telephones operate at frequencies that may cause interference to nearby TVs and VCRs. To minimize or prevent such interference, the base of the cordless telephone should not be placed near or on top of a TV or VCR. If interference is experienced, moving the cordless telephone farther away from the TV or VCR will often reduce or eliminate the interference.

### **More Than One Cordless Telephone**

If you want to use more than one cordless telephone in your home, they must operate on different channels. Press the channel key to select a channel that provides the clearest communication.

### **Cordless Telephone Privacy**

Cordless telephones are radio devices. Communications between the handset and base of your cordless telephone are accomplished by means of radio waves which are broadcasted over the open airways. Because of the inherent physical properties of radio waves, your communications can be received by radio receiving devices other than your own cordless telephone unit. Consequently, any communications using your cordless telephone may not be private.

# Index

## A

- AC adapter information .....39
- Adjusting ringer and earpiece volume.....14

## B

- Battery pack
  - Information .....39
  - Installing .....7
  - Maintenance .....8, 36
  - Preparing and charging ..... 9
  - Replacement and handling ..... 36
- Beltclip installation ..... 35

## C

- Caller ID
  - Caller ID service ..... 28
  - Call Waiting..... 16
  - Deleting ..... 30
  - Setting Caller ID options ..... 26
  - Using ..... 32
  - Viewing ..... 29
- Channel .....16
- Connection ..... 9

## D

- Dialing mode.....10
- Digital security code ..... 4, 34

## E, F, G

- Earpiece volume ..... 14

## H

- Headset installation ..... 35

## I, J, K, L

- Interference .....40
- Language .....26

## M, N, O

- Maintenance ..... 36
- Making a call ..... 13
- Memory dialing
  - Editing a stored name
    - and phone number..... 23
  - Erasing a stored name
    - and phone number..... 25
  - Making calls with memory dialing ..... 21
  - Storing phone numbers and names ..... 19
- Mounting on a wall .....11

## P, Q

- Package contents ..... 5
- Paging ..... 16

## R

- Receiving a call ..... 13
- Redialing a call..... 13, 15
- Ringer tone and volume ..... 14

## S

- Setting up the Phone ..... 6
- Setting up the Handset ..... 7

## T, U, V, W, X, Y, Z

- Technical information .....40
- Troubleshooting ..... 37
- Voice mail .....17

**At Uniden, we'll take care of you!**

If you need any assistance with this product, please call our Customer Hotline at

**1-800-297-1023**

**PLEASE DO NOT RETURN THIS PRODUCT TO THE PLACE OF PURCHASE.**

Our Uniden representatives will be happy to help you with any matters regarding the operation of this unit, available accessories, or any other related matters.

Thank you for purchasing a Uniden product.  
Hours: M-F 7:00 AM to 7:00 PM CST.

# Memo

# Memo

THANK YOU  
FOR PURCHASING A UNIDEN PHONE!

**Uniden®**

Covered under one or more of the following U.S. patents:

4,511,761 4,523,058 4,595,795 4,797,916 5,381,460 5,426,690  
5,434,905 5,491,745 5,533,010 5,574,727 5,650,790 5,660,269  
5,661,780 5,663,981 5,671,248 5,717,312 5,754,407 5,768,345  
5,787,356 5,838,721 5,884,619 5,893,034 5,912,968 5,915,227  
5,929,598 5,930,720 5,960,358 5,987,330 6,044,281 6,070,082  
6,125,277

© 2001 Uniden America Corporation, Fort Worth, TX

All rights reserved

UCZZ01319ZA

Printed in China

Download from [www.Somanuals.com](http://www.Somanuals.com). All Manuals Search And Download.



## Free Manuals Download Website

<http://myh66.com>

<http://usermanuals.us>

<http://www.somanuals.com>

<http://www.4manuals.cc>

<http://www.manual-lib.com>

<http://www.404manual.com>

<http://www.luxmanual.com>

<http://aubethermostatmanual.com>

Golf course search by state

<http://golfingnear.com>

Email search by domain

<http://emailbydomain.com>

Auto manuals search

<http://auto.somanuals.com>

TV manuals search

<http://tv.somanuals.com>