

Start  
Here! 1 2 3

*Quick Start Guide Next Page...*



# Quick Start Guide

# WDECT 2310

Wide Band Digital  
Technology provides  
long range,  
the clearest sound  
and the best privacy.

**Uniden®**

## INSTALLATION & SAFETY

Choosing the best location for your phone.  
When choosing a location for your phone there are a number of appliances the phone should not be near, and areas you should avoid.



- This symbol indicates important operating and servicing instructions.

- The earcap of this telephone may attract and retain small metallic objects.

**AVOID -**  
Television sets and  
other electronic  
appliances

**AVOID -**  
Microwave ovens

**AVOID -**  
moisture

**CHOOSE -**  
a central location

**AVOID -**  
other cordless  
telephones

**AVOID -**  
Moisture



**CHARGE -**  
the new phone  
for 17 - 20 hrs.

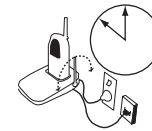

Don't -  
overload the  
power outlet.

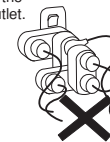

**AVOID -**  
multi power boards.



**AVOID -**  
Computers

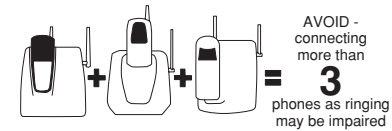

**AVOID -**  
connecting  
more than  
**3**  
phones as ringing  
may be impaired

# Start Here!

1 2 3

## QUICK START GUIDE

This page is a very condensed version of the Owner's Manual. It is designed to allow you to get your phone installed and operating as quickly as possible - however it does not attempt to explain any of the advanced features of the WDECT2310.

### 1 Installing the Base Unit

- 1) Connect the AC adapter to the **AC ADAPTER** jack and to a standard AC wall outlet.

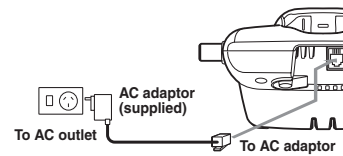

- 2) Connect the telephone line cord to the **TEL LINE** jack and to a telephone socket on the wall.

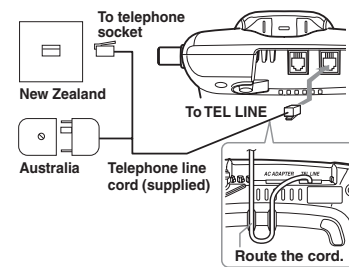

Make sure the AC Adapter/s remains switched ON at all times. Use only the Uniden AC Adapter/s supplied with this unit.



**Use only "AA" rechargeable Ni-MH batteries.** Do Not use Alkaline, Lithium, or non-rechargeable batteries. Using incorrect batteries could damage or limit the performance of this unit.

- 3) Set the base on a desk or tabletop.
- 4) Rise the antenna to a vertical position.

## **2** Installing the AA batteries

- 1) Press down on the battery cover release and slide the cover down until it comes off.
- 2) Install the batteries supplied with your phone, observing correct + - polarity.
- 3) Securely close the battery compartment cover by sliding it up until it snaps into place.

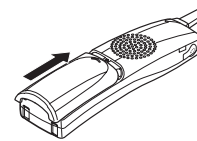
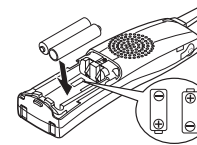
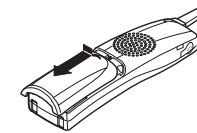
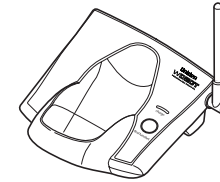

### 3 Charging the handset

- 1) Place the handset in the charging cradle with the keypad facing up.

The WDECT2310 series will only work with "AA" Ni-MH rechargeable batteries. If you use any other type of batteries, the display will show "Use rechargeable battery only".



- 2) Make sure the **charge** LED illuminates. If the LED does not illuminate, check to see that the AC adapter is plugged in and that the handset makes good contact with the base charging contacts.
- After installing the batteries in the handset, charge your handset at least **17-20 hours**.



Recharge your phone on a regular basis by returning the handset to the base after each phone call.



During a power cut or if the AC adapter is switched off, this telephone will not operate.

## CONTENTS

<b>INSTALLATION &amp; SAFETY</b>	<b>i</b>	<b>PHONEBOOK</b>	<b>27</b>
<b>QUICK START GUIDE</b>	<b>ii</b>	Storing Phone Numbers, Names, Distinctive Rings, and Speed Dial	27
<b>CONTENTS</b>	<b>v</b>	Steps for Entering Names and Special Characters	29
<b>GETTING STARTED</b>	<b>1</b>	Viewing the Phonebook	31
Controls and Functions	1	Making Calls Using the Phonebook	32
Uniden Company Philosophy	3	Speed Dialing	32
Welcome	3	Editing or Erasing a Stored Name, Phone Number, Distinctive Ring, and Speed Dial	33
Features	4	Chain Dialing	34
Checking the Package Contents	5	<b>CALLER ID</b>	<b>35</b>
Terminology	5	Viewing the Caller ID List	36
Battery Maintenance	6	Deleting Information from the Caller ID List	37
Installing the Beltclip	7	Using the Caller ID Message List	38
Headset Installation	8	<b>ADDITIONAL INFORMATION</b>	<b>39</b>
Display and Icons	8	Changing the Digital Security Code	39
About Soft Key Function	9	Note on Power Sources	40
WDECT2310 Flow Chart	10	<b>TROUBLESHOOTING</b>	<b>41</b>
About the Menu	12	<b>INDEX</b>	<b>43</b>
Setting up the Menu	14	<b>WARRANTY</b>	<b>44</b>
<b>BASICS</b>	<b>20</b>		
Making and Receiving Calls	20		
Placing a Call on Hold	21		
Redialing a Call	22		
Adjusting the Earpiece and Handset Speaker Volume	23		
Clarity Booster	23		
Ringer Mute (temporarily)	24		
Mute Microphone	24		
Traveling Out-of-Range	24		
Find Handset	25		
Flash and Call Waiting	25		
Using One Touch Voice Mail Access	26		

[ v ]

## CONTROLS AND FUNCTIONS

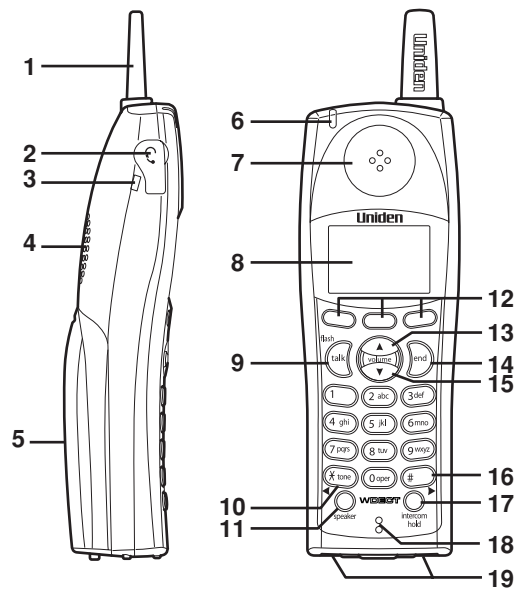

1. Handset Antenna
2. Headset Jack Cover
3. Beltclip Hole
4. Hands Free Speaker
5. Handset Battery Compartment
6. Voice Mail LED
7. Handset Earpiece
8. LCD Display
9. **talk**/flash Key
10. **\*/<** Key
11. **speaker** Key
12. Soft Keys
13. **volume**/▲ (up) Key
14. **end** Key
15. **volume**/▼ (down) Key
16. **#/▶** Key
17. **intercom/hold** Key
18. Handset Microphone
19. Handset Charging Contacts

GETTING STARTED

[ 1 ]

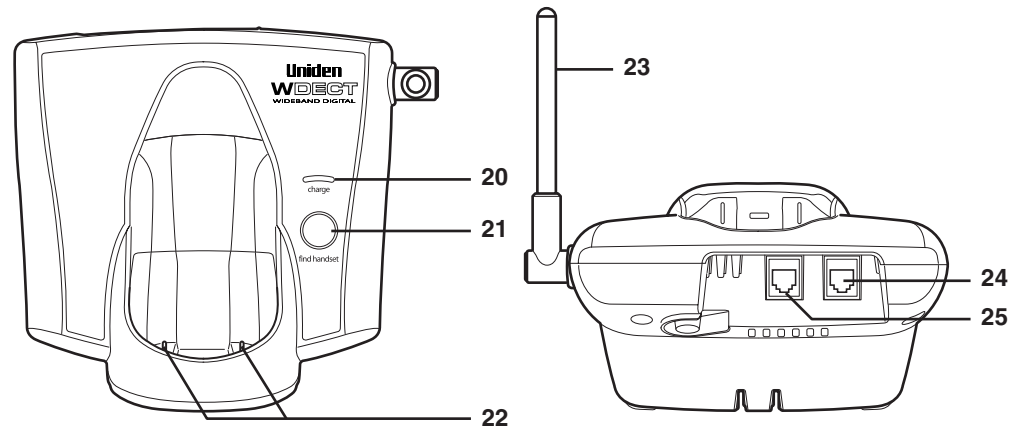

- 20. Charge LED
- 21. **find handset** Key
- 22. Base Charging Contacts
- 23. Base Antenna
- 24. Telephone Line Jack
- 25. DC Power Input

[ 2 ]



## UNIDEN COMPANY PHILOSOPHY

To bring outstanding wireless communication products to people's lives throughout the world.

## WELCOME

Congratulations on your purchase of this Uniden cordless telephone. This is designed for reliability, long life and outstanding performance utilising the latest in Wide Band Digital Technology.

**Note:** Some illustrations in this manual may differ from the actual unit for explanation purposes.

## FEATURES

Great features of this cordless phone include:

- Designed and Engineered in Japan
- Wide Band Digital Technology
- Long Range (up to 600m) #
- Digital Duplex Speakerphones on Handset

Advanced Alpha Display Caller ID Features:

- Alpha Memory Dialling
- POP ID - Caller Name Identification\*
- 16 Individual Caller Tone Allocation (8 Rings/8 Melodies)
- 100 Caller ID \* Memories with Phonebook
- Backlit Keypad on Handset
- 4 Line Backlit Full Dot Matrix LCD Display with Clock
- Maxi-Sound - Extra Loud Handset Volume Control
- And More!

\* Caller ID and POP ID features work only if you subscribe to the service provided by your local telephone company. There is usually a fee for this service.

# Range may vary depending on environmental and/or topographical conditions.

## CHECKING THE PACKAGE CONTENTS

Make sure you have received the following items in the package. If any of these items are missing or damaged, contact your retailer.

- Base unit
- Handset
- AC adapter
- Rechargeable batteries (2)
- Telephone cord or adapter (Australia)
- Telephone cord (New Zealand)
- Beltclip

### Also included:

- This Owner's Manual
- Other Printed Material

## TERMINOLOGY

Throughout this manual, terms such as Standby and Talk Mode are used. Below is the terminology explanation.

**Standby Mode** - The handset is not in use, is off the cradle, and **(talk)**/flash or **(speaker)** has not been pressed. A dial tone is not present.

**Talk Mode** - The handset is not in the cradle and **(talk)**/flash or **(speaker)** has been pressed enabling a dial tone. "Talk" appears on the display.

## BATTERY MAINTENANCE

### Battery use time (per charge)

Fully charged (17-20 hours charge time)

- Up to 7 hours continuous use (up to 5 hours when the clarity booster is on)
- Up to 14 days when the handset is in the standby mode

Recharge your phone on a regular basis by returning the handset to the base after each phone call.

### Low battery alert

When the batteries are very low and need to be charged, the phone is programmed to eliminate functions in order to save power.

The batteries need to be charged when:

- The empty battery icon  appears.
- "Low Battery" appears in the display.

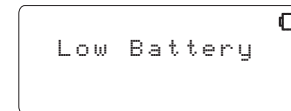

If the phone is in the standby mode, none of keys will operate. If you are on a call, complete your conversation as quickly as possible, and return the handset to the cradle.

### Cleaning the battery charging contacts

To maintain a good charge, it is important to clean the charging contacts on the handset once a month. Use a dry cloth or pencil eraser to clean.



contacts

## Battery replacement and handling

When the operating time becomes short, even after a battery is recharged, please replace the battery.  
Please use only "AA" rechargeable Ni-MH batteries.

### Caution

- Use only "AA" rechargeable Ni-MH batteries.
- Do not remove the batteries from the handset to charge them.
- Never throw the batteries into a fire, disassemble them, or heat them.
- Do not remove or damage the battery casing.



To avoid the risk of personal injury or property damage from fire or electrical shock, only use the Uniden adapter model specifically designated for this product, and "AA" rechargeable Ni-MH batteries.

## INSTALLING THE BELTCLIP

### To attach the beltclip

Insert the beltclip into the holes on each side of the handset. Press down until it clicks into place.

### To remove the beltclip

Pull both sides of the beltclip to release the tabs from the holes.



## HEADSET INSTALLATION

Your phone may be used with an optional headset, the Uniden HS910. To use this feature, insert the headset plug into the headset jack. Your phone is ready for hands-free conversations. Headset is available through Uniden authorized retailers.



## DISPLAY AND ICONS

Example of the standby mode display

Ringer off icon (when the ringer is Off)

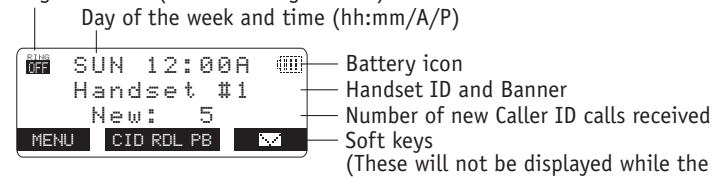

(These will not be displayed while the handset is charging in the cradle.)

ICON	STATUS	DESCRIPTION
	Standby/Talk	<b>Battery</b> icons indicate the handset battery status. This icon cycles depending on the battery status (empty, low, medium, and full).  indicates that the batteries installed are not for use with this phone, remove the batteries immediately.
	Standby	<b>Ringer off</b> icon indicates that ringer is set to Off.
	Standby	<b>Voice mail</b> soft key is used to access the voice mail (you will need to program the voice mail number to use this feature).
	Talk	<b>Mute</b> icon appears when you mute the handset.
	Talk	<b>Speaker</b> icon appears when the handset speaker phone is used.

## ABOUT SOFT KEY FUNCTION

In the standby mode

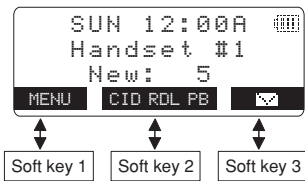

In the talk mode  
(Australia model)

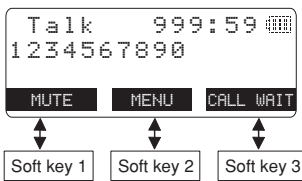

(New Zealand model)

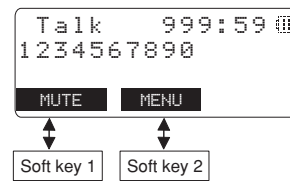

Soft key functions consists of soft key icons and soft keys (No. 1, 2, and 3). Each soft key corresponds to the icon displayed above, and each icon will be changed depending on the operation. Press the corresponding soft key to enter a menu, or select an item. In this manual, we refer to this combination of icons and keys as the soft key.

For example, you will use the soft keys when you want to:

- Access the main menu
- Access Caller ID messages stored
- Store or edit phone numbers
- Redial one of the last three numbers dialed from the handset
- Etc....

**Note:** The soft key icons will not appear while charging the handset.

## WDECT2310 FLOW CHART

### • From the standby mode

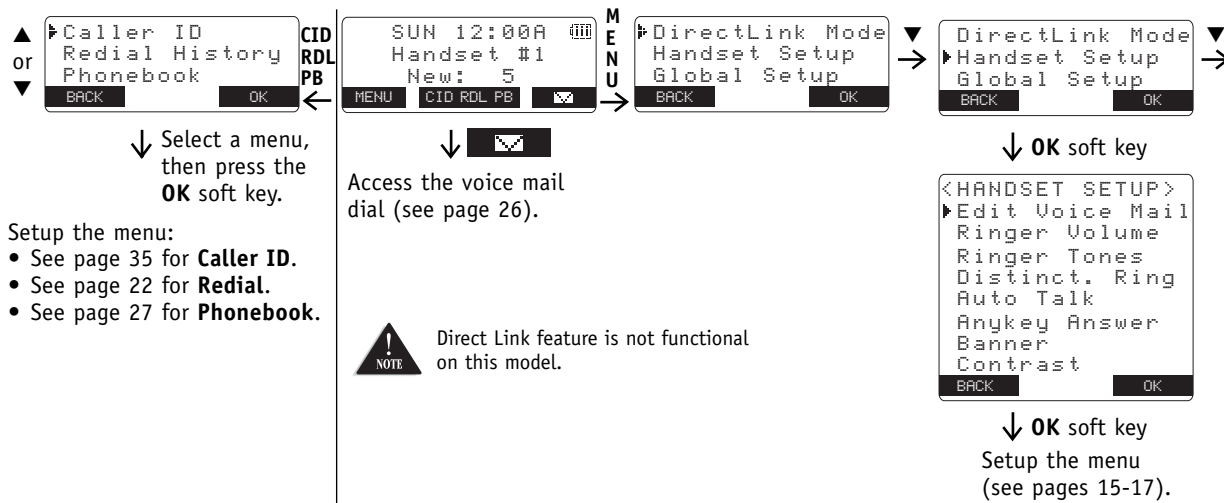



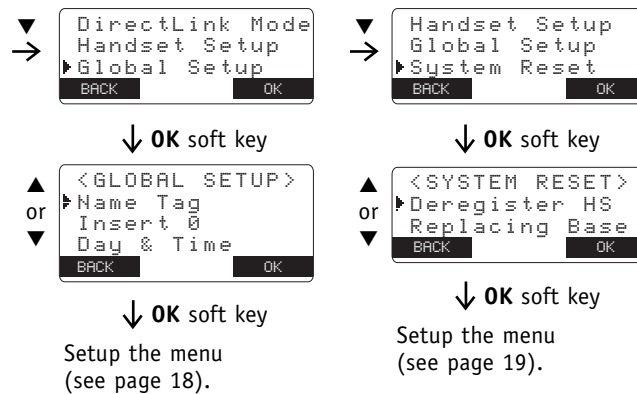

**NOTE** "Insert 0" is available only for New Zealand model.

### • From the Talk mode

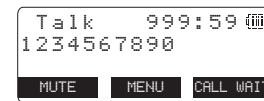

- Press the **MUTE** soft key to mute a call (see page 24).
- Press the **MENU** soft key, then select:
  - "Booster On" to improve the sound quality (see page 23).
  - "Caller ID" to view Caller ID list (see page 36).
  - "Phonebook" to view phonebook locations (see page 31).
  - "Redial History" to view the last three number dialed (see page 22).
- Press the **CALL WAIT** soft key to access the Call Waiting (see page 25) (Australia only).



- For Global Setup and System Reset (Deregister HS) menu, make sure the line is not in use, and the handsets are within the range limits of the base.
- Direct Link feature is not functional on this model.

## ABOUT THE MENU

Most of the handset settings are set from the menu. The menu has 4 main menus (**DirectLink Mode, Handset Setup, Global Setup, and System Reset**) and submenus respectively.

### Summary of the Main Menu and Submenu

#### Handset Setup

Submenu name	Description
Edit Voice Mail	Program or delete the voice mail access number (see page 15).
Ringer Volume	Adjust the ringer volume (see page 15).
Ringer Tones	Adjusting the ringer tone (see page 16).
Distinct. Ring (Distinctive ring)	Set the distinctive ring (see page 16). "Distinctive Ring" allows you to preset memory locations with a designated ring tone. When an incoming call is received and the Caller ID information matches the information in one of the memory locations, the distinctive ring that has been stored for that particular Caller will sound. If you have set multiple memory locations with distinctive rings, switching the setting to "Distinctive Off" will result in no distinctive ringing. All incoming calls will have a normal ring tone. Switching to "Distinctive On" will activate all programmed distinctive ring memory locations.

Submenu name	Description
AutoTalk	Allows you to answer the phone without pressing (talk)/flash or (speaker). When the AutoTalk is set to On, simply remove the handset from the cradle and the phone automatically answers the call (see page 16).
Anykey Answer	Allows you to answer the phone without pressing (talk)/flash or (speaker). When the Anykey Answer is On, you can answer a call by pressing any number key, (X)/◀ or (E)/▶ on the handset (see page 17).
Banner	Customize the name of your handset, and display it in the LCD in the standby mode. For example, you can name the handset "John" (see page 17).
Contrast	Adjust the handset LCD brightness for better viewing (10 levels) (see page 17).

### Global Setup

Submenu name	Description
Name Tag (POP ID)	Display the stored name with the Caller ID telephone number, if the displayed Caller ID telephone number is exactly the same as a number stored in the phone book (see page 18).
Insert 0 (New Zealand only)	Add "0" or "00" to the number, when you receive the Caller ID message (see page 18).
Day & time	Set the day and time of your display (see page 18).

### System Reset

This menu is used to clear the handset ID from the base, or the base ID from the handset.

Submenu name	Description
Deregister HS	Clear the handset ID from the base. Use this menu, for example when you change the digital security code (see page 19).
Replacing Base	Clear the base ID. Use this menu, for example, if you wish to deregister the base to use the handset with another base of the DSS series. (DSS2415/DSS2455/DSS2465/WDECT2310 series) (see page 19).



Direct Link feature is not functional on this model.

## SETTING UP THE MENU

### Entering the Menu

- 1) Press the **MENU** soft key in the standby mode.
- 2) Use **(volume)**/▲ or ▼ to move the pointer to a desired main menu (**DirectLink Mode, Handset Setup, Global Setup, and System Reset**).
- 3) Press the **OK** soft key to enter the menu. To return to the previous screen, press the **BACK** soft key.
- 4) Use **(volume)**/▲ or ▼ to select a desired submenu, then press the **OK** soft key to enter.

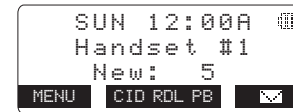

MENU

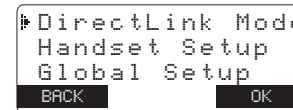

In the submenu, **(volume)**/▲ or ▼ is used to select an item. Press the **OK** soft key to confirm your selection. To return to the previous screen, press the **BACK** soft key. For detailed instructions, see the following sections for the desired submenu.

- 5) To exit the menu, press **(end)**.



- If any of the following occurs during the menu operation, the operation will be cancelled.
  - Press **(end)**.
  - Press **(talk)**/flash or **(speaker)**.
  - Charge the handset.
  - Receive an outside call or page.
- If the handset remains idle for 30 seconds, the phone will return to the standby mode.

## Handset Setup

### Programming your Voice Mail Access Number

- 1) Enter the "Handset Setup" menu, then the "Edit Voice Mail" submenu (see "Entering the Menu" on page 14).
- 2) Enter your personal access number using the number keypad (0-9),  $\otimes$ / $\blacktriangleleft$ ,  $\#$ / $\blacktriangleright$ , the **PAUSE** soft key, or the **DELETE** soft key.
- 3) Press the **OK** soft key. You will hear a confirmation tone.

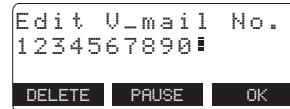

To delete the current Voice Mail Access Number, delete all numbers in step 2 using the **DELETE** soft key and press the **OK** soft key.

### Setting a Ringer Volume

- 1) Enter the "Handset Setup" menu, then the "Ringer Volume" submenu (see "Entering the Menu" on page 14).
- 2) Press  $\text{volume}$ / $\blacktriangle$  or  $\blacktriangledown$  to adjust the ringer settings (Ringer Volume Off, Ringer Volume Low, or Ringer Volume High). You will hear a ringer or melody at the Selected volume (if you select "Ringer Volume Off", no ringer or melody will sound).
- 3) Press the **OK** soft key. You will hear a confirmation tone.

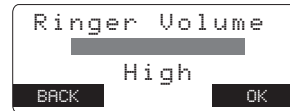

- Voice Mail Access Numbers :  
Australia  
Message Bank : 125101  
Home Messages : 101  
New Zealand  
Call Minder : 083210

- If you select "Ringer Volume Off",  icon appears in the display.



If you set the ringer to Off , the ringer tone will not sound.

### Selecting a Ringer Tone

- 1) Enter the "Handset Setup" menu, then the "Ringer Tones" submenu (see "Entering the Menu" on page 14).

You can choose from 8 ringers or 8 melodies:

- Ringers [Flicker, Clatter, Soft Alert, Wake Up, Light Bug, Beep Boop, Tone Board, Chip Chop]
- Melodies [Beethoven's Symphony #9 (Beethoven9), For Elise (Elise), We Wish You A Merry Christmas (Merry-Xmas), Home Sweet Home (Hm Swt Hm), Lorri Song #6 (Lorri Song), When the Irish Eyes Are Smiling (Irish Eyes), Aura Lee, Let Me Call You Sweet Heart (Sweetheart)]

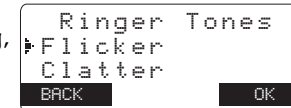

- 2) Press  / ▲ or ▼ to move the pointer. You will hear the ringer or melody as you scroll through the options.
- 3) Press the **OK** soft key. You will hear a confirmation tone.

### Distinctive Ringer Setup

- 1) Enter the "Handset Setup" menu, then the "Distinct. Ring" submenu (see "Entering the Menu" on page 14).
- 2) Press  / ▲ or ▼ to select "On" or "Off".
- 3) Press the **OK** soft key. You will hear a confirmation tone.

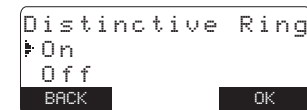

### Setting the AutoTalk

- 1) Enter the "Handset Setup" menu, then the "Auto Talk" submenu (see "Entering the Menu" on page 14).
- 2) Press  / ▲ or ▼ to change the selection, "On" or "Off".
- 3) Press the **OK** soft key. You will hear a confirmation tone.

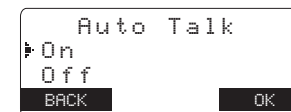

### Setting the Anykey Answer

- 1) Enter the "Handset Setup" menu, then the "Anykey Answer" submenu (see "Entering the Menu" on page 14).
- 2) Press **(volume)/ ▲** or **▼** to change the selection, "On" or "Off".
- 3) Press the **OK** soft key and you will hear a confirmation tone.

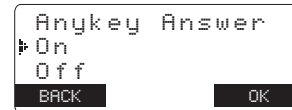

### Setting the Banner

- 1) Enter the "Handset Setup" menu, then the "Banner" submenu (see "Entering the Menu" on page 14).
- 2) Use the number keypad (**0-9**), **(\*)/◀**, **(#)/▶**, or the **DELETE** soft key to enter or edit the name. To delete all characters, press and hold the **DELETE** soft key, then enter the new name.
- 3) Press the **OK** soft key. You will hear a confirmation tone.



### Adjusting the LCD Contrast

- 1) Enter the "Handset Setup" menu, then the "Contrast" submenu (see "Entering the Menu" on page 14).
- 2) Press **(volume)/ ▲** or **▼** to adjust the contrast of the LCD (10 levels).
- 3) Press the **OK** soft key. You will hear a confirmation tone.



If you don't enter a banner, the phone will use the handset ID for the banner (for example: Handset #1).



For setting the Day and Time, the idle time-out is extended to 2 minutes.

## Global Setup

### Setting Name Tag (POP ID)

- 1) Enter the "Global Setup" menu, then the "Name Tag" submenu (see "Entering the Menu" on page 14).
- 2) Press (volume) / ▲ or ▼ to change the selection, "On" or "Off".
- 3) Press the **OK** soft key. You will hear a confirmation tone.

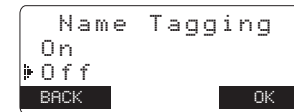

### Setting Day and Time

- 1) Enter the "Global Setup" menu, then the "Day & Time" submenu (see "Entering the Menu" on page 14).
- 2) Press (volume) / ▲ or ▼ to select the day of the week, then press the **NEXT** soft key.
- 3) Press the number keypad (**0-9**) to set the time, then press the **NEXT** soft key.
- 4) Press (volume) / ▲ or ▼ to choose "AM" or "PM", then press the **OK** soft key. You will hear a confirmation tone.

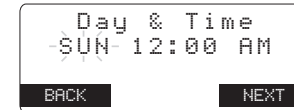

### Setting Insert Zero (New Zealand only)

- 1) Enter the "Global Setup" menu, then the "Insert 0" submenu (see "Entering the Menu" on page 14).
- 2) Press (volume) / ▲ or ▼ to change the selection, "On" or "Off".
- 3) Press the **OK** soft key. You will hear a confirmation tone.

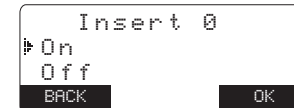



## System Reset

### Deregister the Handset

1) Enter the "System Reset" menu, then the "Deregister HS" submenu (see "Entering the Menu" on page 14).

2) Press the **OK** soft key.

3) Press the **OK** soft key. You will hear a confirmation tone.

When deregistration is complete, "Deregistration Complete" appears.

4) After deregistering the handset, move to "Deregister the Base Setting" below.

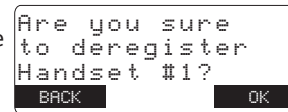

### Deregister the Base Setting

1) Enter the "System Reset" menu, then the "Replacing Base" submenu (see "Entering the Menu" on page 14). "Do you want to replace Base?" appears.

2) Press the **OK** soft key. You will hear a confirmation tone.

The base information will be deleted.

When replacing the base is complete, "Please Register" appears, register the handset(s) to the new base.

3) Place the handset in the base unit to begin registration.

4) While the handset is registering, "Handset Registering" will appear in the LCD. When "Registration Complete" is displayed, the handset has been registered to the base.

If "Registration Failed" appears, please try these steps again.

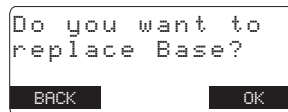



**NOTE**

- To set "Auto Talk", see page 16 or "Anykey Answer" see page 17.
- The handset microphone is located at the bottom of the handset (see "Controls and Functions" on page 1). Position yourself as near to the handset as possible and speak clearly.

BASICS

**MAKING AND RECEIVING CALLS**

On the handset, you may also use the speakerphone while talking to an outside call. Using the handset speakerphone is called "hands-free conversation". This feature allows you to easily communicate while performing other tasks, such as cooking.  appears on the handset display during hands-free conversations.

You can easily switch a call from normal conversation to "hands-free conversation". To switch a call, press **(speaker)** during the call.

	Normal conversation	Hands-free conversation
To answer a call	<p><b>Handset On the Cradle</b> Pick up the handset (AutoTalk) or pick up the handset and press <b>(talk)</b>/flash.</p> <p><b>Handset Off the Cradle</b> Press any number key, <b>(*)</b>/◀, or <b>(#)</b>/▶ (Any Key Answer), or press <b>(talk)</b>/flash.</p>	<p><b>Handset Off the Cradle</b> Press <b>(speaker)</b>.</p>
To make a call	<p><b>Handset Off the Cradle</b></p> <ol style="list-style-type: none"> <li>1) Press <b>(talk)</b>/flash.</li> <li>2) Listen for the dial tone.</li> <li>3) Dial the number.</li> </ol> <p><b>OR</b></p> <p>Dial the number, then press <b>(talk)</b>/flash.</p>	<p><b>Handset Off the Cradle</b></p> <ol style="list-style-type: none"> <li>1) Press <b>(speaker)</b>.</li> <li>2) Listen for the dial tone.</li> <li>3) Dial the number.</li> </ol> <p><b>OR</b></p> <p>Dial the number, then press <b>(speaker)</b>.</p>
To hang up	Press <b>(end)</b> , or return the handset to the cradle (AutoStandby).	
To enter a pause within the dialing sequence	When you dial the number in the standby mode, press the <b>PAUSE</b> soft key. "P" appears in the display, which represents a pause.	

## PLACING A CALL ON HOLD

- 1) During a call, press **intercom/hold**. The call will be put on hold.
- 2) To talk to the caller, press **talk/flash** or **speaker** on a handset. The phone will return back to the call.

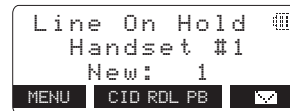

You can hold a call for 5 minutes, when 5 minutes has passed, the call is disconnected and the phone returns to the standby mode.



If you press **(end)**, the operation is canceled.

## REDIALING A CALL

The last three phone numbers dialed can be quickly redialed.

### Redialing from Standby Mode

- 1) Press the **CID RDL PB** soft key in the standby mode.
- 2) Press **(volume)/ ▲ or ▼** to select "Redial History", then press the **OK** soft key. The phone number that was last dialed appears in the display.
- 3) Press **(volume)/ ▲ or ▼** to toggle through the last three phone numbers dialed.
- 4) Press **(talk)/flash or (speaker)**. The selected number is dialed.
- 5) To hang up, press **(end)**.

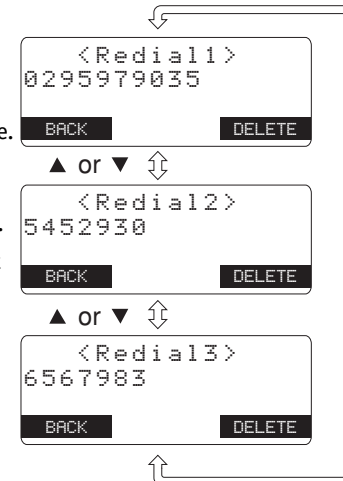

### Redialing from Talk Mode

- 1) Press **(talk)/flash or (speaker)**, then press the **MENU** soft key.
- 2) Select the number you dialed by following steps 2-3 in "Redialing from Standby Mode". To return to go back, press the **BACK** soft key.
- 3) Press the **DIAL** soft key.
- 4) To hang up, press **(end)**.

### Deleting a Redial Record

- 1) In the standby mode, recall the desired number by following steps 1-3 in "Redialing from Standby Mode".
- 2) Press the **DELETE** soft key.
- 3) Press **(volume)/ ▲ or ▼** to choose "Yes".
- 4) Press the **OK** soft key. The redialed number is deleted.



## ADJUSTING THE EARPIECE AND HANDSET SPEAKER VOLUME

You can select different volume levels for the handset earpiece and the handset speaker (4 levels: Low to Max). The volume can only be adjusted during a call. Press **(volume)**/**▲** or **▼** to select the volume settings. When you hang up, the phone keeps the last volume setting selected.



- If you press **(volume)**/**▲** in the maximum volume level or **(volume)**/**▼** in the lowest volume level, you will hear a beep.
- **CALL WAIT** soft key appears only for Australia model.

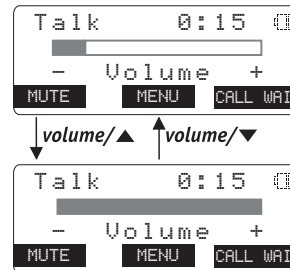

## CLARITY BOOSTER

If you encounter interference while using your phone, you can manually improve the sound quality for clear operation. This works only when you make an outside call.

- 1) Press the **MENU** soft key.
- 2) Select "Booster On", then the **OK** soft key. "Clarity Booster" appears in the display.

To turn Off the Clarity Booster, press the **MENU** soft key, select "Booster Off", then press the **OK** soft key again.

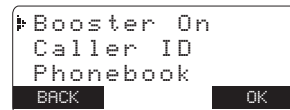

**NOTE**

- Normally, the talk time duration is 7 hours, however, when the Clarity Booster is On, the talk time duration will be up to 5 hours with fully charged batteries.
- Clarity booster automatically turns off after each call.



If you press **(end)** to cancel muting, the call is disconnected and the phone will return to the standby mode.

### **RINGER MUTE (temporarily)**

You can temporarily mute the ringer tone. When the handset is off the cradle and the phone is ringing, press the **MUTE** soft key. The ringer tone will return to the previous setting starting with the next incoming call.

### **MUTE MICROPHONE**

You can temporarily turn Off the microphone so that the person you are talking with cannot hear you.

During a telephone call press the **MUTE** soft key to turn Off the microphone. "Mute" and **[M]** appear in the display. Press the **MUTE OFF** soft key to cancel muting.

### **TRAVELING OUT-OF-RANGE**

During a call, as you begin to move your handset too far from your base unit, noise may increase. If you pass the range limits of the base unit, you will hear a beep and "Out of Range" appears, then the handset returns to the standby mode. You may return back to the call if you move your handset within the range limits of the base, and press **(talk)/flash** or **(speaker)** within 30 seconds.

## FIND HANDSET

To locate the handset, press **find handset** on the base when the base is in the standby mode. The handset beeps for 60 seconds, and "Paging" appears on the handset display. Paging is canceled when pressing any key on the handset or **find handset** on the base. Additionally, if you receive an outside call, page is canceled.

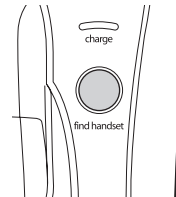

- If the handset batteries are completely drained, the handset will not beep when paging.

## FLASH AND CALL WAITING

If the call waiting tone sounds during a call:

**AUSTRALIA:** Press the **CALL WAIT** soft key.

**NEW ZEALAND:** Press **talk**/flash to switch between callers.

To return to the original caller, press **talk**/flash again.

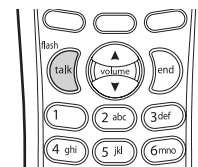

- You must subscribe through your local telephone company to receive Call Waiting Service.

**NOTE**



- You must subscribe to voice mail service from your telephone company in order to use this feature. The voice mail service company will provide you with the access number.

## USING ONE TOUCH VOICE MAIL ACCESS

If you subscribe to voice mail service, you can use your phone to access your voice mailbox. The **voice mail** LED flashes whenever you have messages waiting in your voice mailbox. Just program the handset with your access number and you can get your messages at the touch of a button. (The voice mail service provider will supply you with the access number. This number may be simply a phone number. Refer to the provider's literature.)

- **To program or delete your Voice Mail Access Number** ⇨ See page 15.

### Dialing your Voice Mail Service

Once you've programmed your personal access number, you can dial your mailbox with the touch of a button. When you have messages, simply pick up the handset and press the  soft key. If you have not entered the access number or it has been deleted, when you press the  soft key, "No Number Stored Press [MENU] to store number" appears and you will hear a beep. The phone returns to the standby mode.

### Voice Mail Access

The voice mail LED on the handset is designed to work with your voice mail service provided by your local telephone company. The LED flashes when you have new incoming messages in the voice mail service.

You may need to occasionally reset the indicators if they remain On after you've retrieved your messages. To reset the indicators, when the phone is in the standby mode press and hold  on the base until the paging sound stops (about 5 seconds).

- Voice Mail Access Numbers :  
Australia  
Message Bank : 125101  
Home Messages : 101  
New Zealand  
Call Minder : 083210



## PHONEBOOK

Phonebook allows you to dial a number using just a few key presses. Your phone stores names/numbers in the phonebook memory location, and you can search names in alphabetical order. You have a total of 100 locations that can be used for the phonebook (including the Speed dials) and Caller ID messages.



- If any of the following occurs during a phonebook operation, the operation will be canceled.
  - Press **end**. The phone will return to the standby mode (or the call will be disconnected).
  - Press **talk**/flash or **speaker**.
  - Receive an outside call or page.
  - Charge the handset
- If the handset remains idle for 30 seconds, the phone will return to the standby mode (or back to the call).

## STORING PHONE NUMBERS, NAMES, DISTINCTIVE RINGS, AND SPEED DIAL

- 1) When the phone is in the standby mode, press the **CID RDL PB** soft key.
- 2) Press **volume**/▲ or ▼ to move pointer to "Phonebook", then press the **OK** soft key. The handset displays the following items:
  - (1st line) The number of the phonebook locations used
  - (2nd line) How to search (press the number keypad, **volume**/▲ or ▼)
  - (3rd line) How to enter the storing operation (press the **STORE** soft key)
  - (4th line) The **BACK** and the **STORE** soft keys.

```
Phonebook : 50
Search [A-Z/↑/↓]
Store [STORE]
BACK      STORE
```



You have a total of 100 locations. However, Caller ID messages and Phonebook share the memory locations.

PHONEBOOK



- When the memory is full, you will hear a beep and "Memory Full" appears. You cannot store names and numbers.
- The pause key counts as one digit. Pressing the **PAUSE** soft key increases the length of the pause between numbers. Each pause represents a 2 second delay.
- Distinctive ringing will only operate if you subscribe to the Caller ID service.
- Selecting a speed dial location where a number is already stored, releases the old number's speed dial setting. The new number will be stored in the speed dial location.

3) Press the **STORE** soft key, "Store/Edit Name" appears.

4) Enter the name (up to 16 characters) by using the number keypad (see the "Steps for Entering Names and Special Characters" on page 29).



If a name is not required, go to step 5. <No Name> will be used as the name.

5) Press the **OK** soft key to store the name, "Store/Edit No." appears.



6) Press the number keypad to enter the phone number (up to 20 digits), press the **OK** soft key to store the number.

7) "Distinctive Ring" appears. Press **(volume)/ ▲** or **▼** to move the pointer to one of the Distinctive Ring options, then press the **OK** soft key.

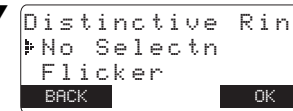

If you choose not to store a "Distinctive Ring", simply select the "No Selectn" option.

8) "Speed Dial" appears. Press **(volume)/ ▲** or **▼** to move the pointer to select the Speed dial location (10 locations: SPD1-SPD0).

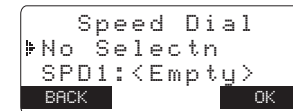

If you choose not to store the name/number as a Speed Dial, simply select the "No Selectn" option.

9) Press the **OK** soft key. You will hear a confirmation tone and "Done!" appears in the display.



## STEPS FOR ENTERING NAMES AND SPECIAL CHARACTERS

Refer to the letters on the number keys to select the desired characters. With each press of a number key (0-9), the displayed character appears in the following order: Upper case letters first, lower case letters next and finally the number corresponding to the key.

keys	Number of times key is pressed								
	1	2	3	4	5	6	7	8	9
1	1								
2 abc	A	B	C	a	b	c	2		
3 def	D	E	F	d	e	f	3		
4 ghi	G	H	I	g	h	i	4		
5 jkl	J	K	L	j	k	l	5		
6 mno	M	N	O	m	n	o	6		
7 pqrs	P	Q	R	S	p	q	r	s	7
8 tuv	T	U	V	t	u	v	8		
9 wxyz	W	X	Y	Z	w	x	y	z	9
0 oper	&	<	>	<	>	/	(blank)	-	-
	.	,	:	?	!	@	'	"	*
	#	0							



If the next character uses the same number key, you must press **(#)/▶** to move the cursor over. Otherwise the next time you press the number key, it changes the character that was previously set.

#### **If you make a mistake while entering a name**

Use **(X)/◀** or **(#)/▶** to move the cursor to the incorrect character. Press the **DELETE** soft key to erase the wrong character, then enter the correct character. To delete all characters, press and hold the **DELETE** soft key.

For example, to enter **Movies**:

- 1) When the phone is in the standby mode, recall the "Phonebook" menu by following steps 1-2 in "Storing Phone Numbers, Names, Distinctive Rings, and Speed Dial" on page 27.
- 2) Press the **STORE** soft key, "Store/Edit Name" appears.
- 3) Press **6** once to select "M", then press **(#)/▶** to move the cursor to the right.
- 4) Press **6** six times to select "o".
- 5) Press **8** six times to select "v".
- 6) Press **4** six times to select "i".
- 7) Press **3** five times to select "e".
- 8) Press **7** eight times to select "s".
- 9) When finished, press the **OK** soft key.

To continue to store the telephone number, proceed to step 6 on page 28.

## VIEWING THE PHONEBOOK

Your phone stores names/numbers in the phonebook memory locations, and you can search names in alphabetical order. You can view the phonebook even while the phone is in use.

- 1) Press the **CID RDL PB** soft key (or the **MENU** soft key during a call).
- 2) Press **(volume)/ ▲** or **▼** to move the pointer to "Phonebook", then press the **OK** soft key.

If you recall the phonebook during a call, the following screen appears.

```
Phonebook : 50
Search [A-Z/↑/↓]
Store [STORE]
BACK STORE
```

```
Phonebook : 50
Search [A-Z/↑/↓]
BACK
```

- 3) Press **(volume)/ ▲** or **▼**, or the number keypad to scroll through the phonebook locations. Phonebook locations appear in alphabetical order (from first to last when you press **(volume)/ ▼**, from last to first when you press **(volume)/ ▲**).  
Or, refer to the letters on the number keys to select the first letter of the desired name. Press a number key (**2-9** and **0**) once for the first letter, press twice for the second letter, and so on. The first location that begins with the letter you entered appears.  
For example, to search for "Movies", press **6** once.  
Press **(volume)/ ▲** or **▼** until the phonebook location is displayed.

- 4) To finish the viewing operation, press the **BACK** soft key repeatedly or **(end)**.



- "/SPDn" appears when you view a speed dial.

```
Movies
0800123456789
Flicker /SPD2
BACK DELETE EDIT
```

- During a call, don't press **(end)** or the call will be disconnected.



While the telephone is automatically dialing a number from speed dial memory, the speaker phone function is disabled for a few seconds.

## MAKING CALLS USING THE PHONEBOOK

### From Standby Mode

- 1) When the phone is in the standby mode, view the phonebook location to dial (see "Viewing the Phonebook" on page 31).
- 2) Press **(talk)/flash** or **(speaker)**. The displayed number is dialed.
- 3) To hang up press **(end)**.

Movies
0800123456789
Flicker /SPD2
BACK DELETE EDIT

### From Talk Mode

- 1) Press **(talk)/flash** or **(speaker)**.
- 2) View the phonebook location to dial (see "Viewing the Phonebook" on page 31).
- 3) Press the **DIAL** soft key. The number in the displayed phonebook location is dialed.
- 4) To hang up press **(end)**.

## SPEED DIALING

If you store a phone number in a speed dial memory location (10 locations: SPD1 - SPD0), you can use the speed dialing feature. When the phone is in the standby mode, press and hold a number key (**0-9**) associated with the speed dial until the phone number appears, then press **(talk)/flash** or **(speaker)**. The number stored in the speed dial (SPD1 - SPD0) is dialed.

## EDITING OR ERASING A STORED NAME, PHONE NUMBER, DISTINCTIVE RING, AND SPEED DIAL

- 1) When the phone is in the standby mode, press the **CID RDL PB** soft key.
- 2) Press **(volume)/ ▲** or **▼** to move the pointer to "Phonebook", then press the **OK** soft key.
- 3) Press **(volume)/ ▲** or **▼**, or the number keypad to view the phonebook locations (see "Viewing the Phonebook" on page 31).

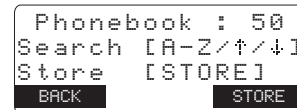

### a. Editing the Stored Data

- 1) When the phonebook location to be edited appears, press the **EDIT** soft key. "Store/Edit Name" appears.
- 2) Follow the steps 4 to 8 under "Storing Phone Numbers, Names, Distinctive Rings, and Speed Dial" on page 28 to complete the editing operation.
- 3) Press the **OK** soft key. You will hear a confirmation tone.



### b. Deleting the Stored Data

- 1) When the phonebook location to be deleted appears, press the **DELETE** soft key. "Delete Memory?" appears.
- 2) Press **(volume)/ ▲** to move the pointer to "Yes".
- 3) Press the **OK** soft key. You hear a confirmation tone. "Deleted!" appears in the display.



## CHAIN DIALING

The memory locations in the handset are not limited to phone numbers. You can also store a group of numbers (up to 20 digits), that you need to enter once your call connects. This is referred to as Chain Dialing.

An example of this is a bank account number. Store a special number in the phonebook location (refer to "Storing Phone Numbers, Names, Distinctive Rings and Speed Dial" on page 27). Once you have called your bank, and when you are prompted to enter the account number, just as you do when viewing the phonebook location, view the special number, then press the **DIAL** soft key.



## CALLER ID

### You must subscribe to Caller ID service to use this feature.

When the telephone rings, the Caller ID feature allows you to view the caller's name and phone number in the display before you answer the phone. Additionally, you can dial the displayed number and store the information for memory dialing.

### Important:

Memory locations for Caller ID messages and Phonebook locations (including Speed Dials) are common, you can store up to 100 in total. A Caller ID message is not stored when you have stored 100 of the phonebook locations. The earliest Caller ID message is overwritten when you have stored 100 of the phonebook locations and Caller ID messages in total.



- If any of the following occurs during Caller ID operation, the operation will be canceled.
  - Press **end**. The phone will return to the standby mode (or the call will be disconnected).
  - Press **talk**/flash or **speaker**.
  - Receive an outside call or page.
  - Charge the handset.
- If the handset remains idle for 30 seconds, the phone will return to the standby mode (or back to the call).

- 1) When the Caller ID message is received, the display shows the caller's phone number along with the date and time. The incoming call information is stored in the Caller ID record.  
The current telephone network in Australia and New Zealand does not show the caller name.

**The date and time received**  
**Caller's name**  
**Caller's phone number**  
**Soft keys**

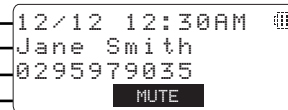

- If you answer a call before the Caller ID message is received (Example: before the second ring), the Caller ID message will not appear.
- When the call is received via a telephone company that does not offer Caller ID service, the caller's phone number does not appear. (This includes some international calls.)
- When the call is via a private branch exchange (PBX), the caller's phone number may not appear.



**NOTE**

- The number of calls from the same Caller ID appears next to the received time. Once you have reviewed the new message, the number will be cleared and disappears.

- During a call, don't press **(end)** or the call will be disconnected.

[ 36 ]

You may receive any one of the following messages:

When invalid data is received	"Incomplete Data"
When a private name or number is received	"Private"
When a unknown name or number is received	"Unavailable"
When the mobile phone number and date are received	"Mobile"
When a call is coming from a payphone (Australia only)	"Payphone"
When a overseas call is received (New Zealand only)	"OVERSEAS CALL"

- 2) When you pick up the phone, the display changes to "Talk" (AutoTalk feature is set to On).

### VIEWING THE CALLER ID LIST

The Caller ID list stores information for incoming calls – even unanswered calls. You can store 100 of the Caller ID messages and Phonebook locations (including Speed Dials) in total. You can view the Caller ID list during a call or when the phone is in the standby mode.

- 1) Press the **CID RDL PB** soft key in the standby mode (or the **MENU** soft key during a call).
- 2) Press **(volume)/ ▲** or **▼** to move the pointer to "Caller ID", then press the **OK** soft key. The screen shows the number of new messages and the total number of messages.
- 3) To view the Caller ID messages in historical order (from new to old or from old to new), repeatedly press **(volume)/ ▼** to scroll through the messages from the latest to the earliest, or **(volume)/ ▲** to scroll back through the messages.

Or, to view the Caller ID messages with alphabetical search, press the number key pad **(2-9 and 0)** with the letter associated with the first letter of the desired message.



Once you view the Caller ID list with alphabetical search, you cannot switch back to historical order (from new to old or from old to new) unless you exit and re-enter the operation.

- 4) To finish the viewing operation, press the **BACK** soft key repeatedly or **(end)**.

## DELETING INFORMATION FROM THE CALLER ID LIST

### Deleting a Caller ID message

- 1) When the phone is in the standby mode, view the Caller ID information to be deleted (see "Viewing the Caller ID List" on page 36).
- 2) Press the **DELETE** soft key.  
"Delete Caller ID" appears.
- 3) Press **(volume) / ▲ or ▼** to choose "Yes".
- 4) Press the **OK** soft key. You will hear a confirmation tone.

```

Delete Caller ID
▶ Yes
  No
  BACK          OK
  
```

### Deleting all Caller ID names/numbers

- 1) When the phone is in the standby mode, press the **CID RDL PB** soft key.
- 2) Press **(volume) / ▲ or ▼** to move the pointer to "Caller ID", then press the **OK** soft key.  
The number of new and total records appear.
- 3) Press the **DELETE** soft key.
- 4) Press **(volume) / ▲ or ▼** to choose "Yes".
- 5) Press the **OK** soft key. You will hear a confirmation tone.

```

Caller ID
New : 5
Total: 25
  BACK          DELETE
  
```

```

Delete All?
▶ Yes
  No
  BACK          OK
  
```



### NOTE

Once the Caller ID data has been deleted, the information cannot be retrieved.

**NOTE**

- You cannot make a call from the Caller ID list if your phone is connected to a private branch exchange (PBX).
- If a call comes in via a telephone system that does not offer Caller ID service, no information is stored.
- If the Caller ID message was received as a private/unknown number, or the message does not have the number, you cannot store the message in the Phonebook.
- Even if the 100 memory locations are full, the message will be stored in the Phonebook. However, the message will be erased from the Caller ID list.

## USING THE CALLER ID MESSAGE LIST

### Calling a party from the Caller ID list

#### From Standby mode

- 1) When the phone is in the standby mode, view the Caller ID message (see "Viewing the Caller ID List" on page 36).
- 2) Press **(talk)**/flash or **(speaker)**. The displayed phone number dials automatically.

12/12 12:30AM
Jane Smith
0295979035
BACK DELETE STORE

#### From Talk mode

- 1) Press **(talk)**/flash or **(speaker)**.
- 2) View the Caller ID message you want to dial (see "Viewing the Caller ID List" on page 36).
- 3) Press the **DIAL** soft key. The displayed phone number will be dialed.

### Adding Zero to Caller ID message (New Zealand only)

While you review Caller ID information while the Insert Zero option is set to On, "0" is inserted. Refer to page 18 "Insert Zero (New Zealand only)" to set the Insert Zero option to On or Off. New Zealand Telecom customers should leave Insert Zero to On. Other New Zealand companies may require Insert Zero set to Off.

### Storing Caller ID messages in the Phonebook

Messages shown in the Caller ID list can be stored in the phonebook. Using the incoming call information (i.e., Caller ID list), the phone number and name of the party on the Caller ID list can be stored in memory.

- 1) When the phone is in the standby mode, view the Caller ID message to be stored. Then press the **STORE** soft key. "Store/Edit Name" appears.
- 2) To complete the setting, follow the steps 4-9 in "Storing Phone Numbers, Names, Distinctive Rings, and Speed dial" on page 28.

## CHANGING THE DIGITAL SECURITY CODE

The digital security code is an identification code used to connect the handset and the base unit. Normally, setting the code is not necessary. In the rare situation that you suspect another cordless telephone is using the same security code, you can change the code. To change the digital security code:

- 1. Perform the "System Reset" menu options ("Deregister the Handset" and "Deregister the Base Setting") for the handset you have (see page 19).**
- 2. To register the handset do the following steps:**
  - 1) Place a handset in the base.
  - 2) Registration starts automatically.  
While registering "Handset Registering" appears in the display.
  - 3) When the registration is complete, "Registration Complete" appears in the display.

If the registration fails, "Registration Failed" appears in the display. Try the steps above again.

ADDITIONAL  
INFORMATION

## NOTE ON POWER SOURCES

### Battery replacement and handling

When the operating time becomes short, even after a battery is recharged, please replace the battery. Please use only "AA" rechargeable Ni-MH batteries.

### Warning

To avoid the risk of personal injury or property damage from fire or electrical shock, only use the Uniden adapter model specifically designated for this product, and "AA" rechargeable Ni-MH batteries.

### Caution

- Use only "AA" rechargeable Ni-MH batteries.
- Do not remove the batteries from the handset to charge them.
- Never throw the batteries into a fire, disassemble them, or heat them.
- Do not remove or damage the battery casing.

## TROUBLESHOOTING

If your phone is not performing to your expectations, please try these simple steps first.

Symptom	Suggestion
The <b>charge</b> LED won't illuminate when the handset is placed in the cradle.	<ul style="list-style-type: none"> <li>• Make sure the AC adapter is plugged into the base and wall outlet.</li> <li>• Make sure the handset is properly seated in the cradle.</li> <li>• Make sure the charging contacts on the handset are clean.</li> </ul>
The audio sounds weak and/or scratchy.	<ul style="list-style-type: none"> <li>• Move the handset and/or base to a different location away from metal objects or appliances and try again.</li> <li>• Make sure that you are not too far from the base.</li> </ul>
Can't make or receive calls.	<ul style="list-style-type: none"> <li>• Check both ends of the base telephone line cord.</li> <li>• Make sure the AC adapter is plugged into the base and wall outlet.</li> <li>• Disconnect the AC adapter for a few minutes, then reconnect it.</li> <li>• Remove the base ID and register the handset (see "Deregister the Base Setting" on page 19).</li> <li>• Make sure that you are not too far from the base.</li> <li>• If an outside call is already established, you may not be able to make another outside call.</li> </ul>
The handset doesn't ring or receive a page.	<ul style="list-style-type: none"> <li>• Charge the batteries in the handset for 17-20 hours by placing the handset on the base or charging cradle.</li> <li>• The handset may be too far away from the base unit.</li> <li>• Place the base unit away from appliances or metal objects.</li> <li>• Remove the base ID and register the handset (see "Deregister the Base Setting" on page 19).</li> </ul>
"Unavailable" appears in the phone again.	<ul style="list-style-type: none"> <li>• Make sure that the base is not in use, and try the display.</li> <li>• Make sure that you are not too far from the base.</li> </ul>

Symptom	Suggestion
Severe noise interference.	<ul style="list-style-type: none"><li>• Keep the handset away from microwave ovens, computers, remote control toys, wireless microphones, alarm systems, intercoms, room monitors, fluorescent lights, and electrical appliances.</li><li>• Move to another location or turn off the source of interference.</li></ul>
The Caller ID does not display.	<ul style="list-style-type: none"><li>• The handset was picked up before the second ring.</li><li>• The call was placed through a switchboard.</li><li>• Call your local telephone company to verify your Caller ID service is current.</li></ul>
Voice Message Indication does not work.	<ul style="list-style-type: none"><li>• Contact your local telephone company to make sure that your telephone receives FSK message signaling.</li></ul>
You cannot register the handset at the base.	<ul style="list-style-type: none"><li>• Please make sure your batteries are charged at least 10 minutes.</li><li>• Remove the base ID and register the handset (see "Deregister the Base Setting" on page 19).</li></ul>
Can not exit the DirectLink mode	<ul style="list-style-type: none"><li>• Place the handset in the charging cradle to cancel the DirectLink mode.</li></ul>
If you still have a problem.	<ul style="list-style-type: none"><li>• Check our web site for the latest information and frequently asked questions. <a href="http://www.uniden.com.au">www.uniden.com.au</a> <a href="http://www.uniden.co.nz">www.uniden.co.nz</a></li></ul>



## INDEX

<b>0 - 9</b>		<b>D</b>		<b>R</b>	
16 ring options .....	16	Deregister the handset .....	19	Receiving a call .....	20
<b>A</b>		Digital security code .....	39	Redialing a call .....	22
Anykey answer.....	17	Distinctive ringer .....	16	Register the handset .....	19
AutoTalk.....	16	<b>E, F, G, H</b>		Ringer volume .....	15
<b>B</b>		Earpiece volume.....	23	<b>S</b>	
Banner.....	17	Hands-free conversation .....	20	Setting up	
Battery		Headset installation.....	8	base unit.....	ii
Preparing and charging .....	iii	<b>I, J, K, L</b>		handset .....	12
Replacement and handling.....	40	Insert Zero .....	18	Soft key function.....	9
Beltclip .....	7	LCD contrast .....	17	Speed dialing .....	32
Booster .....	23	<b>M, N, O</b>		<b>T, U, V, W, X, Y, Z</b>	
<b>C</b>		Making a call .....	20	Troubleshooting.....	41
Caller ID		Mute .....	24	Voice Mail.....	26
Caller ID service .....	35	Overseas call.....	36	Programming.....	15
Calling .....	38	<b>P, Q</b>		Warranty.....	44
Call Waiting .....	25	Package contents.....	5		
Deleting .....	37	Phonebook .....	27		
Storing.....	38	Editing.....	33		
Using.....	38	Erasing.....	33		
Viewing .....	36	Making calls .....	32		
Chain dialing .....	34	Storing.....	27		
Clock .....	18	Viewing .....	31		

## WARRANTY

### One Year Limited Warranty

**Important:** Evidence of original purchase is required for warranty service.  
**Warrantor:** Uniden Australia Pty Limited A.B.N. 58 001 865 498  
Uniden New Zealand Limited

**ELEMENT OF WARRANTY:** Uniden warrants to the original retail owner for the duration of this warranty, its WDECT2310 (herein after referred to as the Product), to be free from defects in materials and craftsmanship with only the limitations or exclusions set out below. Warranty is only valid in the original country of purchase.

**WARRANTY DURATION:** This warranty to the original retail owner only, shall terminate and be of no further effect 12 months after the date of original retail sale. This warranty will be deemed invalid if the product is;

- (A) Damaged or not maintained as reasonable and necessary,
- (B) Modified, altered or used as part of any conversion kits, subassemblies, or any configurations not sold by Uniden,
- (C) Improperly installed,
- (D) Repaired by someone other than an authorized Uniden Repair Agent for a defect or malfunction covered by this warranty,
- (E) Used in conjunction with any equipment or parts or as part of a system not manufactured by Uniden.

**PARTS COVERED:** This warranty covers for one (1) year, the Base Unit and Handset only. All accessories (AC Adapter etc) are covered for 90 days only.

**STATEMENT OF REMEDY:** In the event that the product does not conform to this warranty at any time while this warranty is in effect, the warrantor at its discretion, will repair the defect or replace the product and return it to you without charge for parts or service. THIS WARRANTY DOES NOT COVER OR PROVIDE FOR THE REIMBURSEMENT OR PAYMENT OF INCIDENTAL OR CONSEQUENTIAL DAMAGES. THIS GUARANTEE IS IN ADDITION TO AND DOES NOT IN ANY WAY AFFECT YOUR RIGHTS UNDER THE CONSUMER GUARANTEE ACT.

**PROCEDURE FOR OBTAINING PERFORMANCE OR WARRANTY:** In the event that the product does not conform to this warranty, the Product should be shipped or delivered, freight pre-paid, with evidence of original purchase (eg. a copy of the sales docket), to the warrantor at:

**UNIDEN AUSTRALIA PTY LIMITED SERVICE DIVISION**  
345 Princes Highway, Rockdale NSW 2216  
Fx (02) 9599 3278  
[www.uniden.com.au](http://www.uniden.com.au)

**UNIDEN NEW ZEALAND LIMITED SERVICE DIVISION**  
150 Harris Road, East Tamaki, Auckland  
Fx (09) 274 4253  
[www.uniden.co.nz](http://www.uniden.co.nz)

Customers in other States should ship or deliver the Product freight pre-paid to their nearest Uniden Authorized Repair Centre (Contact Uniden for the nearest Warranty Agent to you).

**MEMO**

**THANK YOU**

FOR PURCHASING A UNIDEN PRODUCT

**Uniden®**

© Uniden Australia Pty Limited  
Uniden New Zealand Limited  
Printed in China  
UPZZ01306EA

## Free Manuals Download Website

<http://myh66.com>

<http://usermanuals.us>

<http://www.somanuals.com>

<http://www.4manuals.cc>

<http://www.manual-lib.com>

<http://www.404manual.com>

<http://www.luxmanual.com>

<http://aubethermostatmanual.com>

Golf course search by state

<http://golfingnear.com>

Email search by domain

<http://emailbydomain.com>

Auto manuals search

<http://auto.somanuals.com>

TV manuals search

<http://tv.somanuals.com>