Table of Contents

Important Safety Instructions	2
Introduction	4
Features	4
Included with the XC3510 SERIES	5
Important Electrical Considerations	6
Range	6
Telephone Line Problems	6
Radio Interference	7
More Than One Cordless Telephone	7
Installation	8
Selecting a Location	8
Telephone Line Outlets	8
Connecting the Telephone Cords	9
Applying Power to the Base Unit	9
Adapter Safety Feature	10
Desk or Tabletop Installation	10
Wall Installation	13
Direct Wall Mounting	16
Setting up your Phone	21
Extending the Antenna	21
Installing the Handset Battery Pack	21
Cleaning the Battery Contacts	23
Charging the Battery Pack	24
Low Battery Indicator	26
Setting the Tone/Pulse Switch	27
Adjusting Ringer Controls	27
Automatic Digital Code Security	29
Using your XC3510 SERIES Phone	31
Making and Receiving Calls	31
Changing Channels, Flash, and Page/Find	32
Programming your Phone	33
Storing a Number in Memory	33
Storing a Tone/Pulse Number With a Pulse Dial System	35
Storing One-Touch Dialing Numbers	37
Dialing a Stored Number	38
Chain Dialing	38
Erasing a Stored Number	39
Troubleshooting	40
Specifications	41

Important Safety Instructions

When using your telephone equipment, these basic safety precautions should always be followed to reduce the risk of fire, electrical shock, and injury to persons:

1. Read and understand all instructions.
2. Follow all warnings and instructions marked on the product.
3. Unplug this product from the wall outlet before cleaning. Use a dry cloth for cleaning without liquid or aerosol cleaners.
4. Do not use this product near water; for example, near a bath tub, wash bowl, kitchen sink or laundry tub, in a wet Basement, or near a swimming pool.
5. Do not place this product on an unstable cart, stand, or table. The telephone may fall, causing serious damage to the unit.
6. Slots and openings in the cabinet and the back or bottom are provided for ventilation. To protect the product from overheating, these openings must not be blocked or covered. This product should never be placed near or over a radiator or heat register. This product should not be placed in a built-in installation unless proper ventilation is provided.
7. This product should be operated only from the type of power source indicated on the marking label. If you are not sure of the type of power supply to your home, consult your dealer or local power company.
8. Do not allow anything to rest on the power cord. Do not locate this product where the cord will be damaged by persons walking on it.
9. Do not overload wall outlets and extension cords, as this can result in the risk of fire or electrical shock.
10. Never push objects of any kind into this product through cabinet slots, as they may touch dangerous voltage points or short out parts that could result in a risk of fire or electric shock. Never spill liquid of any kind on the product.
11. To reduce the risk of electric shock, do not disassemble this product. Take it to qualified service personnel when service or repair work is required. Opening or removing covers may expose you to dangerous voltages or other risks. Incorrect reassembly can cause electric shock when the appliance is subsequently used.

12. Unplug this product from the wall outlet and refer servicing to qualified service personnel under the following conditions:
 - A. When the power supply cord is damaged or frayed.
 - B. If liquid has been spilled into the product.
 - C. If the product has been exposed to rain or water.
 - D. If the product does not operate normally when following the operating instructions. (Adjust only those controls that are covered by the operating instructions. Improper adjustment of other controls may result in damage and will often require extensive repair work by a qualified technician.)
 - E. If the product has been dropped, or the cabinet has been damaged.
 - F. If the product exhibits a distinct change in performance.
13. Do not use the telephone to report a gas leak in the vicinity of the leak.

Caution: *To reduce the risk of fire or injury to persons by the battery, read and follow these instructions:*

1. Use only the appropriate type and size Battery Pack specified in this Operating Guide.
2. Do not dispose of the Battery Pack in a fire. The cell may explode. Check the Nickel-Cadmium Battery Disposal package insert for disposal instructions.
3. Do not open or mutilate the Battery Pack. Released electrolyte is corrosive and may cause damage to the eyes or skin. It may be toxic if swallowed.
4. Exercise care in handling the battery in order not to short the battery with conducting materials such as rings, bracelets, and keys. The battery or conductor may overheat and cause burns.
5. Charge the Battery Pack provided with or identified for use with this product only in accordance with the instructions and limitations specified in the instruction manual provided for this product.
6. Observe proper polarity orientation between the Battery Pack and battery charger.

SAVE THESE INSTRUCTIONS

Introduction

Congratulations on your purchase of the Uniden **XC3510 SERIES** Cordless Telephone. The **XC3510 SERIES** is designed to exacting standards which provide reliability, long life, and outstanding performance.

Note: *This series of Uniden phones is available in designer colors, and these colors are designated by different model numbers. Accordingly, this manual describes the operation of the **XC3510**, **XC3510G**, **XC3514**, and the **XC3515**.*

Features

- 25 46/49 MHz Channels
- Random Code™ Digital Security
- UltraClear Plus
- AutoTalk™
- 10 Number Memory
- Redial/Pause and Flash
- Reversible Handset Retainer
- AutoSecure™
- Tone/Pulse Dialing
- AutoStandby™
- One-Touch Dialing
- 1-way Page/Find Button
- Handset Ringer/Volume Controls
- Battery Saving Feature

The **XC3510 SERIES** features include *AutoTalk™* and *AutoStandby™*. *AutoTalk™* allows you to answer a call by just removing the Handset from the Base so you don't have to waste time pushing buttons or flipping switches. *AutoStandby™* allows you hang up by simply returning the Handset to the Base.

The *UltraClear Plus* true compander circuitry virtually eliminates background noise. This innovative technology together with 25 different switchable channels provides you with the best possible reception during all of your conversations.

To protect you against misbilled calls which might result from your phone being activated by other equipment, the **XC3510 SERIES** has *Random Code™* digital security which automatically selects one of over 65 thousand digital security codes for the Handset and Base Units. Also the *AutoSecure™* feature electronically locks your phone when the Handset is in the Base.

To get the most from your phone, please read this Operating guide thoroughly. Also be sure to complete the Product Registration form and mail it in.

Included with the *XC3510 SERIES*

If any are missing or damaged, do not contact the place of purchase. Instead contact Uniden Customer Service at: (800) 297-1023, 8:00 am to 5:00 pm, Eastern Standard Time, Monday through Friday.



Handset

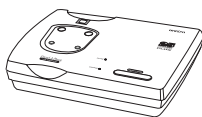

Base Unit



AC Adapter



Long Telephone
Cord

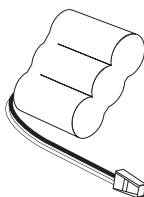

Rechargeable Battery



Short Telephone
Cord



Operating Guide
OMXC3545

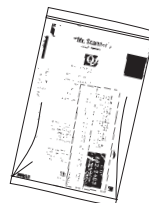

Other Printed
Material

Important Electrical Considerations

Unplug all electrical appliances when you know an electrical storm is approaching. Lightning can pass through your household wiring and damage any device connected to it. Your **XC3510 SERIES** phone is no exception.

Warning: *Please do not attempt to unplug any appliance during an electrical storm.*

Caution: *Changes or modifications to this product not expressly approved by Uniden, or operation of this product in any way other than as detailed by this Operating Guide, could void your authority to operate this product.*

Range

The **XC3510 SERIES** is designed to achieve the maximum possible range by transmitting and receiving according to the highest specifications set forth by the FCC. We have rated this phone to operate at a maximum distance with the qualification that the range depends upon the environment in which the telephone is used. Many factors limit range, and it would be impossible to include all the variables in our rating. The Maximum Range rating of this phone is meant to be used as a means of comparison against other range claims.

Telephone Line Problems

The FCC has granted the telephone company the right to disconnect service in the event that your phone causes problems on the telephone line. Also, the telephone company may make changes in facilities and services which may effect the operation of your unit. However, your telephone company must give adequate notice in writing prior to such actions to allow you time for making necessary arrangements to continue uninterrupted service.

If you are having trouble with your telephone service, you must first disconnect your phone to determine if it is the cause of your problem. If you determine that it is the cause, you must leave it disconnected until the trouble has been corrected.

Radio Interference

Radio interference may occasionally cause buzzing and humming in your cordless Handset, or clicking noises in the Base Unit. This interference is caused by external sources such as TV, refrigerator, vacuum cleaner, fluorescent lighting, or electrical storm. Your unit is NOT DEFECTIVE. If these noises continue and are too distracting, please check around your home to see what appliances may be causing the problem. In addition, we recommend that the Base not be plugged into a circuit that also powers a major appliance because of the potential for interference. Be certain that the antenna on the unit is fully extended when needed.

In the unlikely event that you consistently hear other voices or distracting transmissions on your phone, you may be receiving radio signals from another cordless telephone or other source of interference. If you cannot eliminate this type of interference, you need to change to a different channel.

Finally, it should be noted that some cordless telephones operate at frequencies that may cause interference to nearby TVs and VCRs; to minimize or prevent such interference, the base of the cordless telephone should not be placed near or on top of a TV or VCR; and, if interference is experienced, moving the cordless telephone farther away from the TV or VCR will often reduce or eliminate the interference.

More Than One Cordless Telephone

If you want to use more than one cordless telephone in your home, they must operate on different channels. Press the channel key to select a channel that provides the clearest communication.

Installation

Selecting a Location

Before choosing a location for your new phone, there are some important guidelines you should consider:

- The location should be close to both a phone jack and continuous power outlet. (A continuous power outlet is an AC outlet which does not have a switch to interrupt its power.)
- Keep the Base Unit and Handset away from sources of electrical noise such as motors or fluorescent lighting.
- Be sure there is sufficient space to fully extend the Base Unit antenna.
- The Base Unit can be placed on a desk or tabletop or mounted on a standard AT&T or GTE wall plate.
- If you decide to mount your phone on the wall, make sure to change the handset retainer so that the tab which holds the Handset faces up. (See page 19 for more information.)
- You should charge your new phone for 15-20 hours before completing the installation or using the Handset.

Telephone Line Outlets

There are two types of phone outlets:

Modular Jack

Most phone equipment available now uses modular jacks. Phone cords are fitted with a molded plastic connector which plugs into this type of jack. If you do not have modular phone jacks, contact your local telephone company for information about their installation.

Hard-wired Jack

Some equipment is wired directly to a phone jack, and these types of installations require a modular jack converter. This type of installation is not difficult; however, you should contact your Uniden telephone dealer or a telephone supply store for advise about the proper adapter or converter for your particular situation.

Connecting the Telephone Cords

Consider these safety guidelines before connecting the telephone cords:

CAUTION:

- Never install telephone wiring during a lightning storm.
- Never touch uninsulated telephone wires or terminals unless the telephone line has been disconnected.
- Use caution when installing or modifying telephone lines.

Applying Power to the Base Unit

All the **XC3510 SERIES** phones require a standard electrical outlet (120 volts AC without a switch to interrupt power), and the included AC adapter. Connect the adapter as shown below.

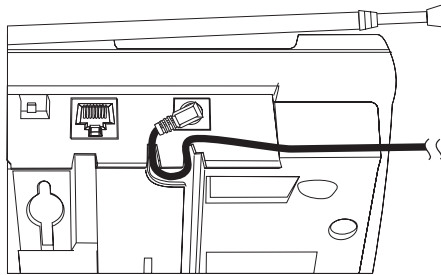

Wrap the power cord around the convenient notch on the bottom.

Important: Place the power cord so that it does not create a trip hazard, or where it could become chafed and create a fire or other electrical hazards.

Adapter Safety Feature

The AC adapter furnished with this phone may be equipped with a polarized line plug — a plug having one blade wider than the other. This plug will fit into the power outlet only one way. If you are unable to insert the plug fully into the outlet, try reversing the plug.

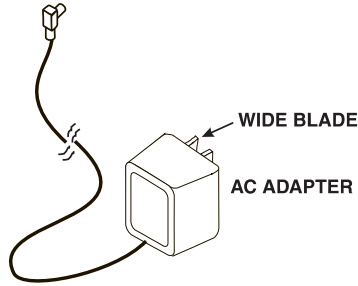

Do not alter the shape of the blades of the polarized plug.

Note: *If you cannot plug the AC adapter into the outlet, contact someone about replacing the outlet.*

Desk or Tabletop Installation

1. Place the Base on a desk or tabletop.

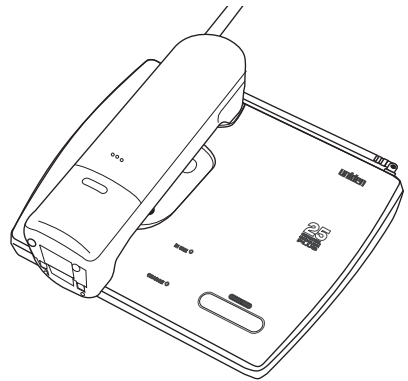

2. Plug the AC Adapter cord into the 9V DC input jack on the Base Unit.

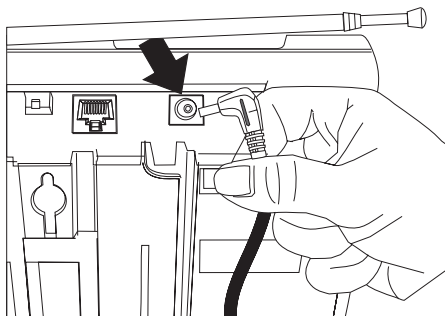

3. Place the AC Adapter cord inside the molded channel.

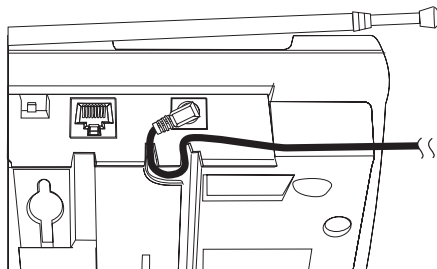

4. Plug one end of the long telephone cord into the **TEL LINE** jack on the Base Unit.

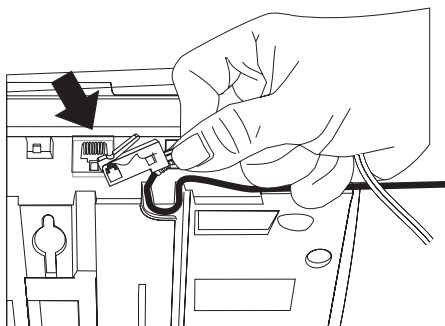

5. Plug the other end of the cord into the telephone jack on the wall.

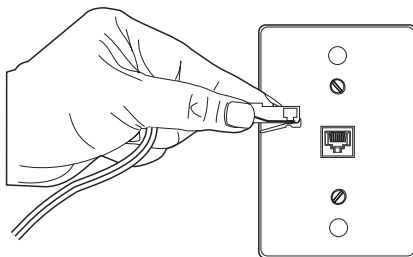

6. Plug the AC Adapter into a standard 120V AC wall outlet.

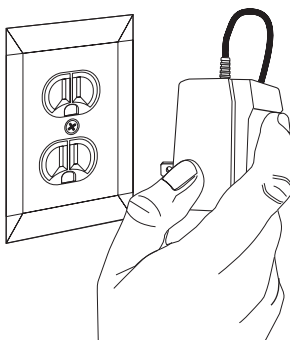

Placement of the Handset

The unique design of your phone allows you to place the Handset on the Base Unit either facedown or in an upright position. The battery is charged in either position.

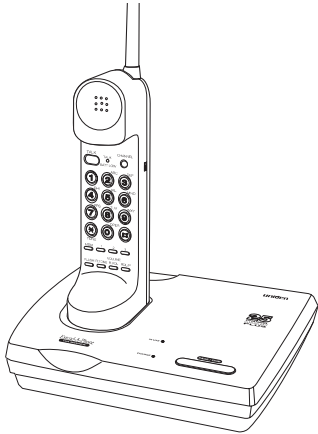

Upright Position for
Handset

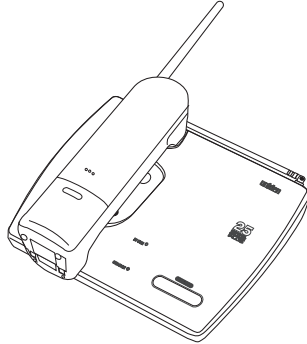

Facedown Position for
Handset

Wall Installation

Standard Wall Plate Mounting

These phones are designed to be mounted on a standard AT&T or GTE wall plate.

1. Plug the AC Adapter into the Base Unit.

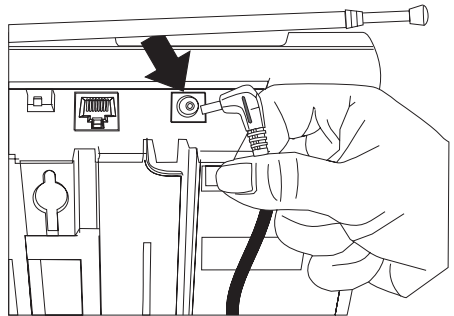

2. Place the AC Adapter cord inside the molded channel.

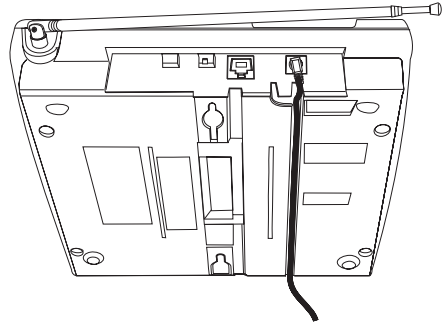

3. Plug one end of the short telephone cord into the **TEL LINE** jack on the Base Unit.

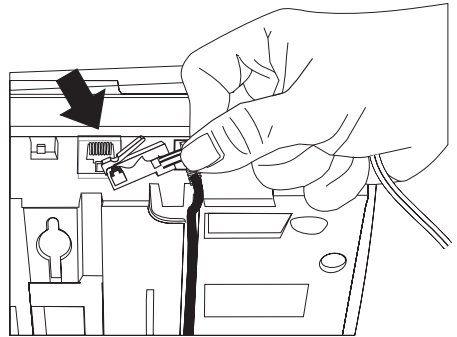

4. Place the telephone cord inside the molded channel on the bottom of the Base Unit.

Then plug the other end of the telephone cord into the modular jack on the wall.

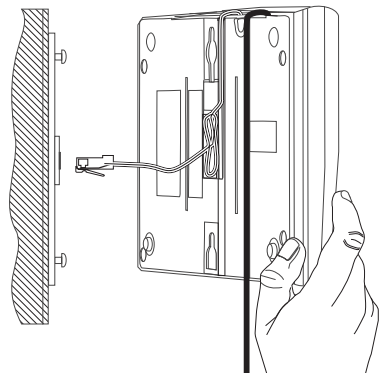

5. Place the Base Unit on the posts of the wall plate and push down until it's firmly seated.

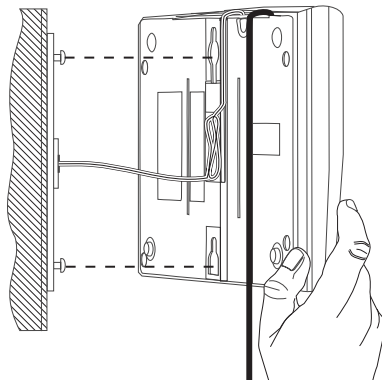

6. Plug the AC Adapter into a standard 120V AC wall outlet.

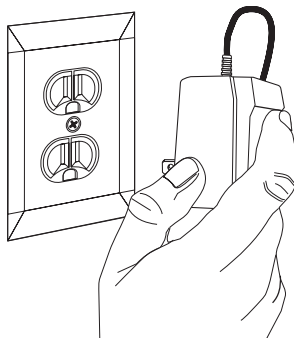

Direct Wall Mounting

If you do not have a standard wall plate, you can mount your phone directly on a wall. Before mounting your phone consider the following:

- Select a location away from electrical cables, pipes, or other items behind the mounting location that could cause a hazard when inserting screws into the wall.
- Make sure the screws are securely fastened.
- Make sure the wall material is capable of supporting the weight of the Base Unit.

1. Insert two mounting screws $3\frac{15}{16}$ inches apart. Allow about $\frac{1}{5}$ of an inch between the wall and screw heads for mounting the phone.

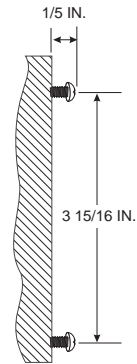

2. Plug the AC Adapter into the Base Unit.

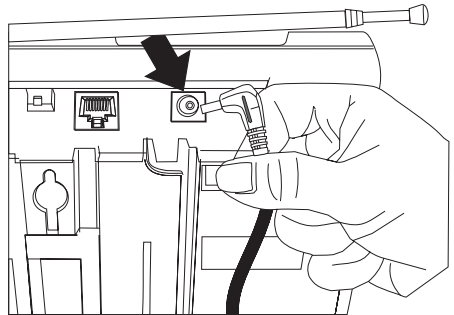

3. Place the AC Adapter cord inside the molded channel.

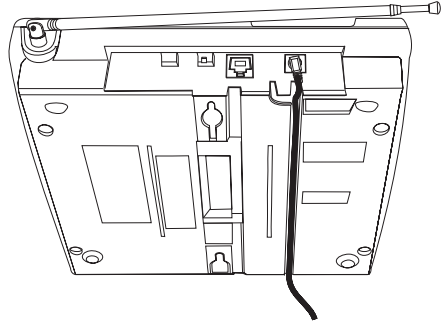

4. Plug one end of the long telephone cord into the **TEL LINE** jack on the Base Unit.

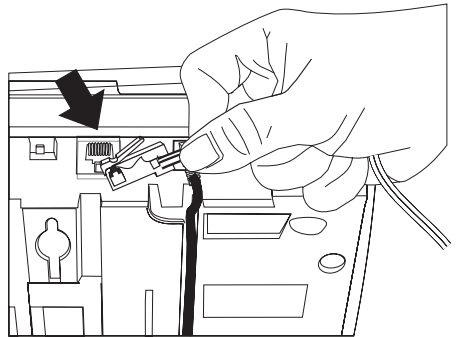

5. Place the cord inside the molded channel on the bottom of the Base Unit.

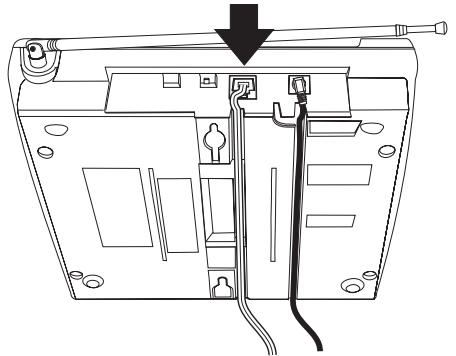

6. Place the Base Unit on the screws and push down until it's firmly seated.

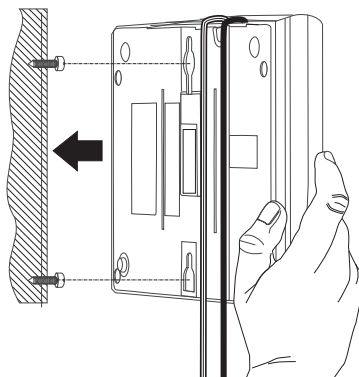

7. Plug the other end of the telephone line cord into the wall jack.

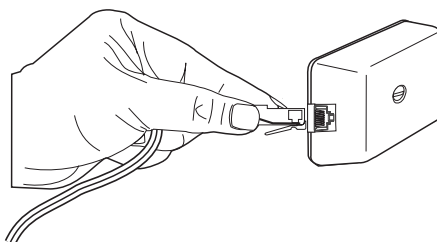

8. Plug the AC Adapter into a standard 120V AC wall outlet.

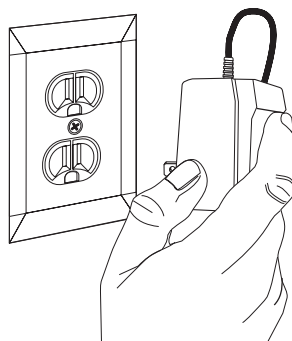

Setting the Handset Retainer

The handset retainer holds the Handset in place if your **XC3510 SERIES** phone is mounted on a wall. The steps below describe how to remove and replace the retainer so that the tab faces up.

1. Push up on the Handset retainer on the Base Unit, and slide the tab out.

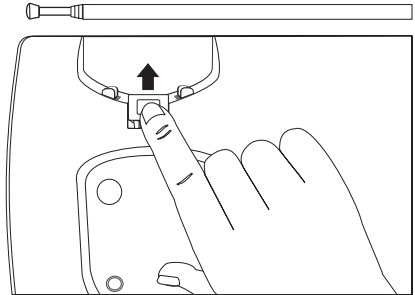

2. Flip the retainer over so the tab faces up.

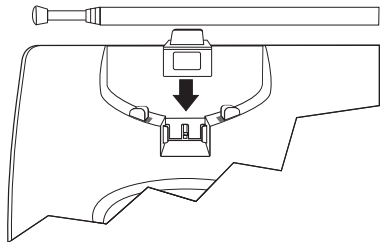
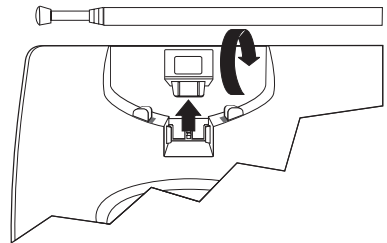

3. Put the retainer back into its slot on the Base Unit.

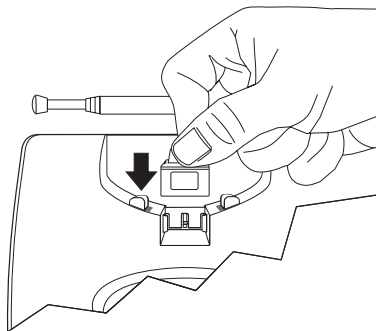

4. Push down on the Handset retainer until it snaps into place.

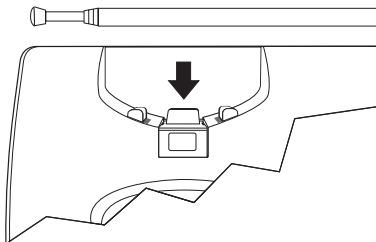

Setting up your Phone

Extending the Antenna

Before using your phone, be sure to raise its antenna to the vertical position.

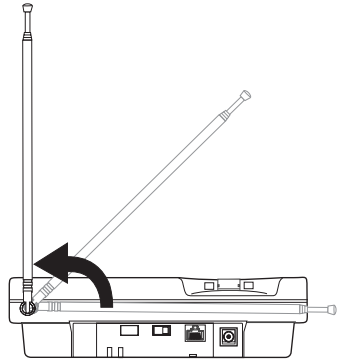

Installing the Handset Battery Pack

1. Press in on the Battery Cover Release.

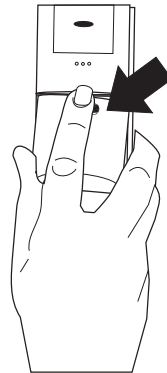

2. Slide the battery compartment cover down.

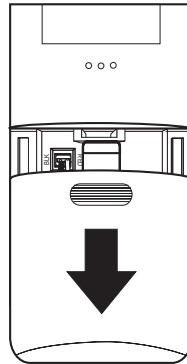

3. Align the plastic connector of the Nickel-Cadmium battery pack with its socket and plug it in.

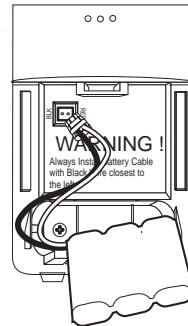

4. Place the battery pack inside the battery compartment, and slide the battery cover back on.

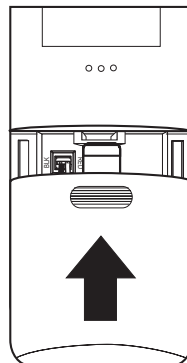

Note: *The built-in Memory Backup feature allows up to 10 minutes to disconnect the old battery pack and install a new one without losing any phone numbers that may be stored in the telephone's memory.*

Charging the Battery Pack

Initial Battery Charging

The rechargeable Nickel-Cadmium battery pack must be fully charged before using your phone for the first time. We recommend that the battery pack charge for approximately 15-20 hours, without interruption, before plugging the phone line into your new phone.

1. Place the Handset on the Base Unit. Depending on your installation, you can charge the Handset in the upright position

—or—

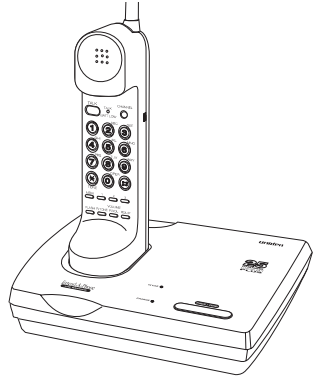

You can charge the Handset in its facedown position.

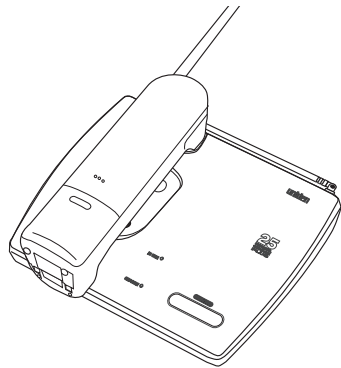

2. Make sure the **CHARGE LED** lights. If the LED doesn't light, check to see that the AC adapter is plugged in, and that the Handset is making good contact with the Base Unit charging contacts.

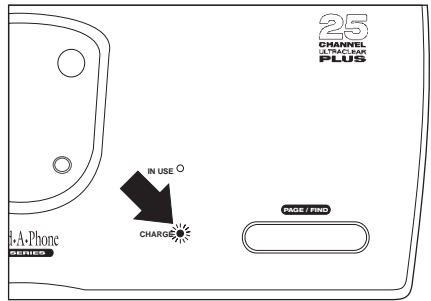

Continuous Battery Charging

For the best battery performance, return the Handset to the Base Unit at the end of the day. This keeps the battery fully charged, so your phone works best.

Low Battery Indicator

When the Battery Pack in the Handset is very low and needs to be charged, the **TALK/BATT LOW LED** flashes.

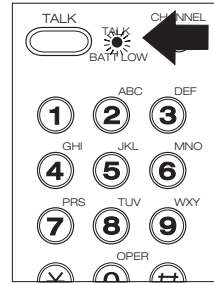

If the **TALK/BATT LOW** LED begins to flash, the phone is programmed to eliminate its functions to save power. The table below describes what to do to return your phone to normal operation.

During a Call	In Standby Mode
Only the  button operates.	None of the buttons will operate.
The Handset beeps and the TALK/BATT LOW LED flashes once every 3 seconds.	The Handset TALK/BATT LOW LED flashes once every 3 seconds.
Complete your call as quickly as possible.	You will not be able to make a call.
Return the Handset to the Base Unit for charging.	Return the Handset to the Base Unit for charging.

Note: Allow 15 to 20 hours without any interruption for the Handset to fully recharge.

Setting the Tone/Pulse Switch

Be sure the **TONE/PULSE** switch is in the **TONE** position.

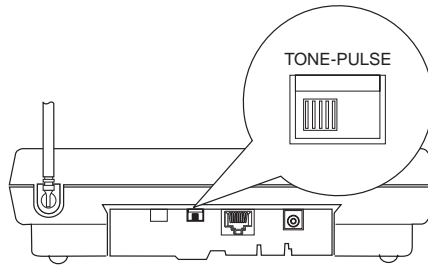

Note: Most phone systems are Tone dialing. Check with your local phone company if you are not sure whether your system is Tone or Pulse dialing.

Adjusting Ringer Controls

To adjust the ringer volume of your Handset, press **R.VOL** when the phone is not in use.

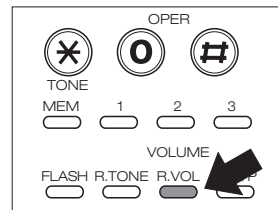

Handset Ringer Volume Control

You can also select one of two different ringer tones for the Handset.

Press **R.TONE** to select a different ringer tone when the phone is not in use.

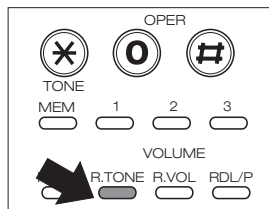

Handset Ringer Tone Select Button

To adjust the receiver volume, press **VOLUME** while you are on a call.

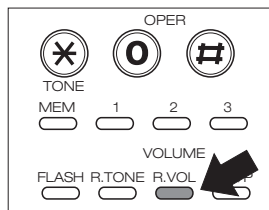

Handset Receiver Volume Control

Automatic Digital Code Security

Many cordless telephones operate similarly and on the same frequency. Without digital code security, another Handset could make calls using your Base Unit and telephone line. To avoid unauthorized calls on your phone, a Digital Code feature was added to all **XC3510 SERIES** phones. This Digital Code is shared only between the Handset and Base Unit. The Code is set *automatically* when you first use the phone.

To reset the Digital Code, be sure the Handset is on the Base, then:

1. Remove the Handset from the Base Unit, and then set it down again.

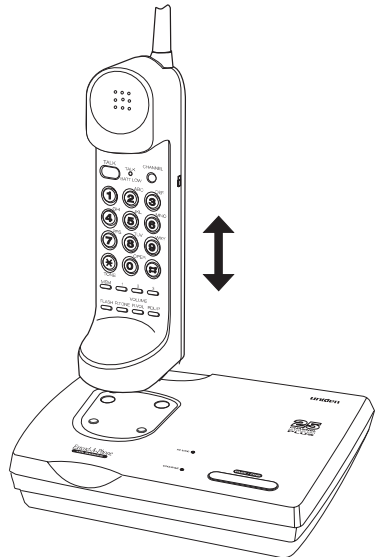

2. The **CHARGE** LED will blink to indicate that the Digital Security Code is set to one of more the 65,000 codes.

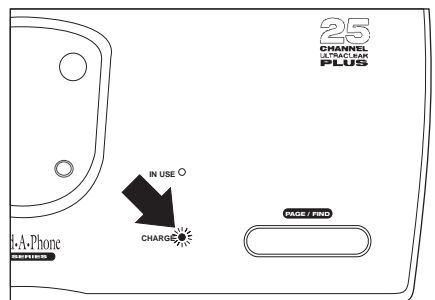

If the Base Unit loses power while the Handset is off the Base, the Digital Code may be erased. When this happens, the Handset will not function. To establish communication between the Handset and Base Unit:

1. Remove the Handset from the Base Unit (if it is on the Base Unit).

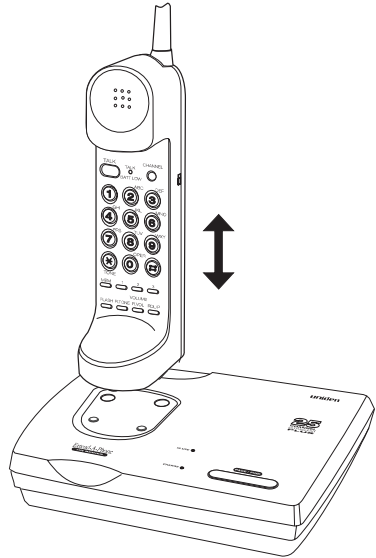

2. Restore power to the Base Unit, and place the Handset back on the Base Unit.
3. The **CHARGE** LED will blink to indicate that the Digital Security Code is set.

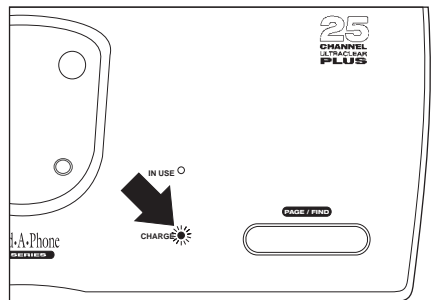

Using your XC3510 SERIES Phone

Making and Receiving Calls





The following features of the XC3510 **SERIES** phones are different depending on the Handset's location when you make or receive a call.

	HANDSET ON BASE	HANDSET OFF BASE
ANSWER CALL	Pick up Handset (AutoTalk)	Press TALK
MAKE CALL	<ol style="list-style-type: none"> 1) Pick up Handset 2) Press TALK 3) Listen for dial tone 4) Dial the number 	<ol style="list-style-type: none"> 1) Press TALK 2) Listen for dial tone 3) Dial the number
HANG UP	Press TALK — OR — Return Handset to Base (AutoStandby)	
REDIAL	<ol style="list-style-type: none"> 1) Pick up Handset 2) Press TALK 3) Listen for dial tone 4) Press RDL/P 	<ol style="list-style-type: none"> 1) Press TALK 2) Listen for dial tone 3) Press RDL/P

Note: Sometimes when you press **TALK** to hang up the phone, you may get an error tone and the phone will not disconnect. If this happens, place the Handset on the Base Unit or press **TALK** again while holding the Handset close to the Base Unit.

Changing Channels, Flash, and Page/Find

To change channels or access call waiting while the phone is in use, or to use the 1-way page to locate the Handset, follow these steps:

	PRESS THESE KEYS	YOU WILL HEAR
CHANGING CHANNELS	Press  Note: <i>Change channels to help eliminate background noise.</i>	A click similar to when  is pressed. There may be a brief pause as your phone searches for a clear channel.
FLASH	If the <i>call waiting</i> tone sounds, press  to accept the waiting call. — OR — If you have finished a call and want to make another call, press  to hang up and get a dial tone.	A click, a short pause, then the caller (if you were on a call) — OR — A click, and then a dial tone so you can make a different call.
PAGE/FIND	Press PAGE/FIND on the Base Unit to locate the Handset.	The Handset will beep 5 times.

Programming your Phone

All programming functions must be completed when your phone is in the standby mode. The programming keys will not function while you are on the phone.

Storing a Number in Memory

Use these keys to store a number in memory.

Note: An error tone will sound and the programming procedure will be cancelled if more than 20 seconds elapses between each keystroke entry or step.

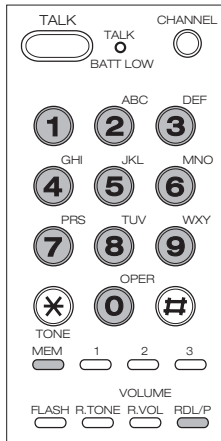

1. Remove the Handset from the Base Unit.
2. Press **MEM**.
The **TALK/BATT LOW LED** blinks.

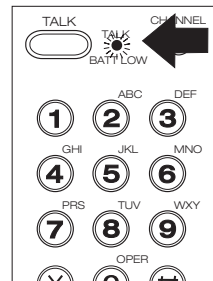

3. Enter the number you want to store (up to 16 digits).



4. If a pause is needed during dialing to access a long distance service, press **RDL/P**.



Note: The **RDL/P** button counts as one digit. Pressing **RDL/P** more than once increases the length of the pause between numbers.

5. Press **MEM** again.
6. Enter the memory location (0-9).
A tone indicates that the number is stored.



Storing a Tone/Pulse Number With a Pulse Dial System

If your phone is set up for pulse dialing, you can store a mixed mode number so that you can easily access long distance services.

Use these keys to store a mixed mode number in memory.

Note: An error tone will sound and the programming procedure will be cancelled if more than 20 seconds elapses between each keystroke entry or step.

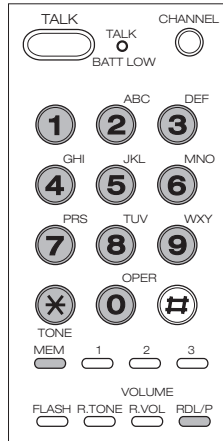

1. Remove Handset from the Base Unit.
2. Press **MEM**.
The **TALK/BATT LOW LED** blinks.

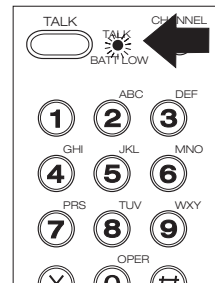

3. Enter the number to be dialed in pulse mode.



4. Press **TONE** on the Handset.

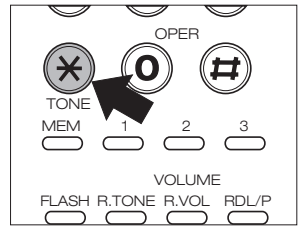

5. Enter the number to be dialed in tone mode.



6. If a pause is needed during dialing to access a long distance service, press **RDL/P**.



Note: The **RDL/P** button counts as one digit. Pressing **RDL/P** more than once increases the length of the pause between numbers.

7. Press **MEM** again.

8. Enter the memory location (0-9).
A tone indicates that the number is stored.



Storing One-Touch Dialing Numbers

Use these keys to store a number in a One Touch dialing button.

Note: An error tone will sound and the programming procedure will be cancelled if more than 20 seconds elapses between each keystroke entry or step.

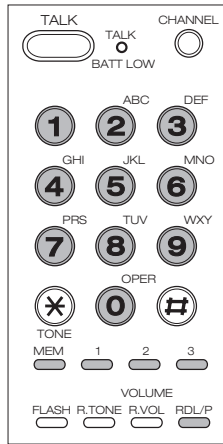

1. Remove the Handset from the Base Unit.
2. Press **MEM**.
The **TALK/BATT LOW LED** blinks.

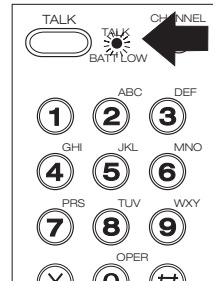

3. Enter the number you want to store (up to 16 digits).
4. If a pause is needed during dialing to access a long distance service, press **ROL/P**.



Note: The **ROL/P** button counts as one digit. Pressing **ROL/P** more than once increases the length of the pause between numbers.

5. Press **MEM** again.
6. Now press the One Touch dialing button (1, 2, or 3) you want to program. *A tone indicates that the number is stored.*



Dialing a Stored Number

To dial a number previously stored in memory, follow these steps:

MEMORY	ONE TOUCH KEYS
Remove the Handset from the Base Unit.	Remove the Handset from the Base Unit.
Press TALK	Press TALK
Press MEM	Press the One Touch dialing button where the number is stored.
Press the memory location number (0-9).	



Chain Dialing

On certain occasions, after dialing a number, you may be requested by the party or service you are calling to enter a special access code, such as when performing a banking transaction. To do this, simply:

1. Store the access code into one of the memory numbers.
2. Dial the main number.
3. At the appropriate time, press **MEM** followed by the memory location number or One Touch Dialing button where the access code is saved.

Erasing a Stored Number

To erase a number previously stored in a memory location (0-9) or in One Touch memory, follow these steps:

MEMORY	ONE TOUCH KEYS
Remove the Handset from the Base Unit.	Remove the Handset from the Base Unit.
Press  twice.	Press  twice.
Press the memory location number (0-9).	Press the One Touch dialing button you want to clear.

Note: *An error tone will sound and the erase procedure will be cancelled if more than 20 seconds elapses between each keystroke entry or step.*

Troubleshooting

If your **XC3510 SERIES** cordless Telephone is not performing to your expectations, please try these simple steps. If you are still unable to resolve the problems, contact Uniden Customer Service at (800) 297-1023, 8:00 a.m. to 5:00 p.m. EST, Monday through Friday.

Problem	Suggestion
Charge light won't come on when Handset is placed in Base Unit.	<ul style="list-style-type: none">● Make sure AC Adapter is plugged into the Base Unit and wall outlet.● Make sure Handset is properly seated in Base Unit.● Make sure that the charging contacts on the Handset and Base Unit are clean.
Audio sounds weak and/or scratchy.	<ul style="list-style-type: none">● Make sure that the Base Unit antenna is fully extended and vertical.● Move the Handset and/or Base Unit to different locations and try again.● Press the CHAN button to select another channel.
Can't make or receive calls.	<ul style="list-style-type: none">● Check both ends of the Base Unit telephone line cord.● Make sure the AC Adapter is plugged into the Base Unit and wall outlet.● Disconnect the AC Adapter for a few minutes, and then reconnect it.
Handset doesn't ring or receive a page.	<ul style="list-style-type: none">● Nickel-Cadmium battery pack may be weak. Charge the battery on the Base Unit for 15 – 20 hours.● Set the RING ON/BATT SAVE switch on the Handset to RING ON.● Extend the Base Unit antenna vertically.● The Handset may be too far away from the Base Unit.● Place the Base Unit away from noise sources.● The Digital Security Code may be erased. Set the Digital Code.

Specifications

General – The **XC3510 SERIES** complies with FCC Part 15 and 68

Frequency Control	Crystal controlled transmission
Modulation	FM
Operating Temperature	- 10° to 50° C

Base Unit

Receive Frequency	48.76 to 49.99 MHz (25 Channels)
Transmit Frequency	43.72 to 46.97 MHz (25 Channels)
Power Requirements	120V AC 60 Hz \pm 3V AC
Size	7 $\frac{3}{4}$ " (W) x 5 $\frac{17}{32}$ " (D) x 1 $\frac{7}{8}$ " (H)
Weight	Approx. 13.1 oz.

Handset

Receive Frequency	43.72 to 46.97 MHz (25 Channels)
Transmit Frequency	48.76 to 49.99 MHz (25 Channels)
Power Requirements	Rechargeable Ni-Cd Battery Pack
Size	2 $\frac{3}{16}$ " (W) x 2 $\frac{11}{16}$ " (D) x 12 $\frac{3}{32}$ " (H) (w/ antenna)
Weight	Approx. 10 oz. (including battery)
Battery	BT-185
Capacity	270 mA _H , 3.6V
Talk Mode	6 hours
Standby Mode	7 days
Battery Save Mode	5 weeks

Specifications, Features, and availability of Optional Accessories are all subject to change without prior notice.

uniden®

XC3510 Series Cordless Telephones



UDZZ01361ZZ

Operating Guide

Download from [Www.Somanuals.com](http://www.Somanuals.com). All Manuals Search And Download.

PRECAUTIONS

Before you read anything else,
please observe the following:

WARNING!

Uniden America Corporation **DOES NOT** represent this unit to be waterproof. To reduce the risk of fire, electrical shock, or damage to the unit, **DO NOT** expose this unit to rain or moisture.

RECHARGEABLE NICKEL-CADMIUM BATTERY WARNING

- This equipment contains a Rechargeable Nickel-Cadmium Battery.
- Cadmium is a chemical known to the State of California to cause cancer.
- The Rechargeable Nickel-Cadmium Battery contained in this equipment may explode if disposed of in a fire.
- **Do not** short circuit the battery.
- **Do not** charge the Rechargeable Nickel-Cadmium Battery used in this equipment in any charger other than the one designed to charge this battery as specified in this Guide . Using another charger may damage the battery, or cause the battery to explode.











RECHARGEABLE NICKEL-CADMIUM BATTERIES MUST BE RECYCLED OR DISPOSED OF PROPERLY

- Residents Of Minnesota should contact 1-800-225-PRBA for information concerning reclamation and disposal of Rechargeable Nickel-Cadmium batteries.
- Residents outside of Minnesota should contact their local authorities for information concerning reclamation and disposal of Rechargeable Nickel-Cadmium batteries.



The exclamation point within an equilateral triangle is intended to alert the user to the presence of important operating and maintenance (servicing) instructions in the literature accompanying the appliance.

Handset Controls and Keys

1. Antenna
2. Talk/Battery Low Indicator
3. Talk Button 
4. Numeric Keypad
5. Tone Button 
6. Memory Programming Button 
7. Flash Button 
8. Ringer Tone Select Button 
9. Channel Select Button 
10. Ring On/Battery Save Switch 
11. One Touch Dialing Buttons
12. Redial/Pause Button 
13. Volume /
Ringer Volume Select Button 

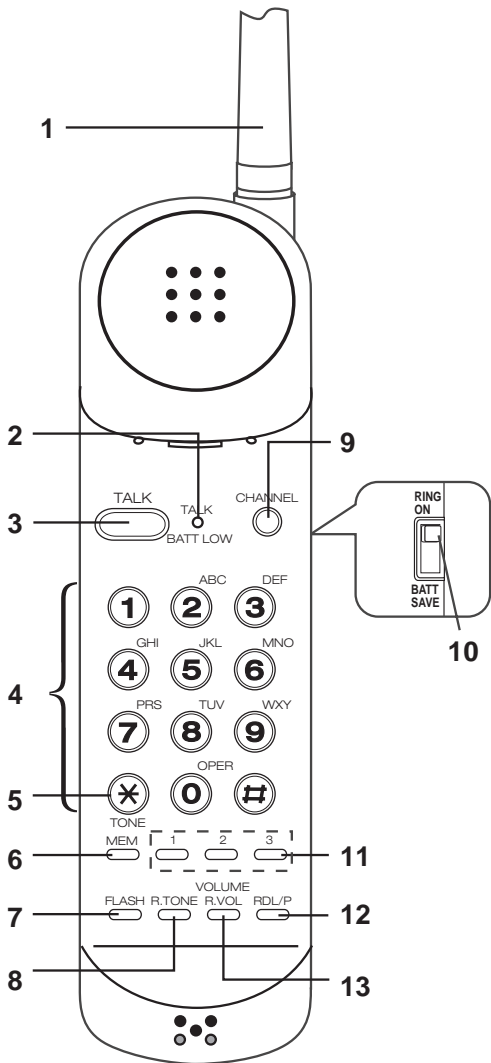

Base Unit Controls and Keys

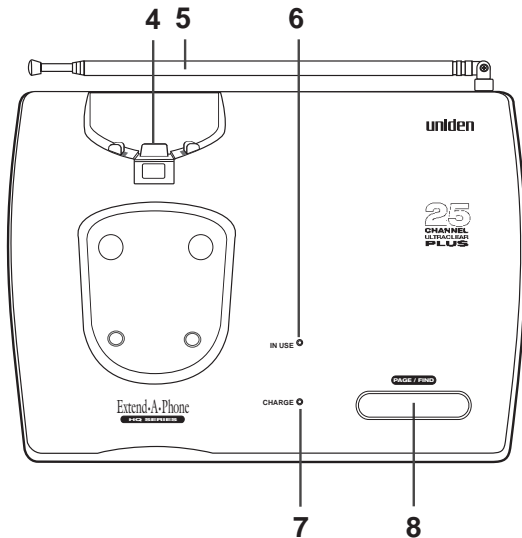
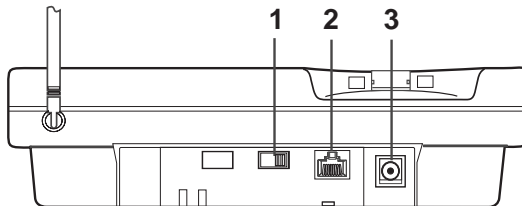

- | | |
|-------------------------------|-----------------------------|
| 1. Tone/Pulse Switch | 5. Base Unit Antenna |
| 2. Telephone Line Jack | 6. In Use LED |
| 3. DC Power Jack | 7. Charge LED |
| 4. Handset Retainer | 8. Page/Find Button |

One Year Limited Warranty

WARRANTOR: UNIDEN AMERICA CORPORATION ("Uniden")

ELEMENTS OF WARRANTY: Uniden warrants, for one year, to the original retail owner, this Uniden Product to be free from defects in materials and craftsmanship with only the limitations or exclusions set out below.

WARRANTY DURATION: This warranty to the original user shall terminate and be of no further effect 12 months after the date of original retail sale. The warranty is invalid if the Product is (A) damaged or not maintained as reasonable or necessary, (B) modified, altered, or used as part of any conversion kits, subassemblies, or any configurations not sold by Uniden, (C) improperly installed, (D) serviced or repaired by someone other than an authorized Uniden service center for a defect or malfunction covered by this warranty, (E) used in any conjunction with equipment or parts or as part of any system not manufactured by Uniden, or (F) installed or programmed by anyone other than as detailed by the Operating Guide for this product.

STATEMENT OF REMEDY: In the event that the product does not conform to this warranty at any time while this warranty is in effect, warrantor will repair the defect and return it to you without charge for parts, service, or any other cost (except shipping and handling) incurred by warrantor or its representatives in connection with the performance of this warranty. THE LIMITED WARRANTY SET FORTH ABOVE IS THE SOLE AND ENTIRE WARRANTY PERTAINING TO THE PRODUCT AND IS IN LIEU OF AND EXCLUDES ALL OTHER WARRANTIES OF ANY NATURE WHATSOEVER, WHETHER EXPRESS, IMPLIED OR ARISING BY OPERATION OF LAW, INCLUDING, BUT NOT LIMITED TO ANY IMPLIED WARRANTIES OF MERCHANTABILITY OR FITNESS FOR A PARTICULAR PURPOSE. THIS WARRANTY DOES NOT COVER OR PROVIDE FOR THE REIMBURSEMENT OR PAYMENT OF INCIDENTAL OR CONSEQUENTIAL DAMAGES. Some states do not allow this exclusion or limitation of incidental or consequential damages so the above limitation or exclusion may not apply to you.

LEGAL REMEDIES: This warranty gives you specific legal rights, and you may also have other rights which vary from state to state. This warranty is void outside the United States of America.

PROCEDURE FOR OBTAINING PERFORMANCE OF WARRANTY: If, after following the instructions in this Operating Guide you are certain that the Product is defective, pack the Product carefully (preferably in its original packaging). Include evidence of original purchase and a note describing the defect that has caused you to return it. The Product should be shipped freight prepaid, by traceable means, or delivered, to warrantor at:

**Uniden America Corporation
Parts and Service Division
8707 North By Northeast Blvd.
P.O. Box 501368
Indianapolis, IN 46250
(800) 297-1023, 8 AM to 5 PM EST, Monday through Friday**

Covered under one or more of the following U.S. patents:

4,511,761

4,595,795

4,797,916

4,523,058

uniden[®]

©1995 Uniden America Corporation. All rights reserved.

Printed in Hong Kong

Free Manuals Download Website

<http://myh66.com>

<http://usermanuals.us>

<http://www.somanuals.com>

<http://www.4manuals.cc>

<http://www.manual-lib.com>

<http://www.404manual.com>

<http://www.luxmanual.com>

<http://aubethermostatmanual.com>

Golf course search by state

<http://golfingnear.com>

Email search by domain

<http://emailbydomain.com>

Auto manuals search

<http://auto.somanuals.com>

TV manuals search

<http://tv.somanuals.com>