

Contents

Important Safety Instructions	3
Battery Safety Precautions	4
Introduction	5
Features	5
Included with the XCA550/55	6
Important Electrical Considerations	6
Range	6
Telephone Line Problems	6
Radio Interference	7
More Than One Cordless Telephone	7
Cordless Telephone Privacy	7
Installation	8
Selecting a Location	8
Telephone Line Outlets	8
Connecting the Telephone Cords	8
Applying Power to the Base Unit	9
Adapter Safety Feature	9
Desk or Tabletop Installation	10
Wall Installation	10
Direct Wall Mounting	11
Setting Up Your Phone	14
Extending the Antenna	14
Installing the Handset Battery Pack	14
Cleaning the Battery Contacts	15
Charging the Battery Pack	15
Low Battery Indicator	16
Setting the Pulse/Tone Switch	16
Setting the Handset Listening Volume	16
Setting Handset Ringer Volume	16
Setting the Base Ringer Volume (XCA555 Only)	16
Automatic Digital Code Security	17
Using Your Phone	18
Making and Receiving Calls	18
Changing Channels, Flash, and Page/Find	18
Programming Your Phone	19
Storing a Number in Memory	19
Storing a Mixed Number	19
Dialing a Stored Number	20
Chain Dialing	20
Erasing a Stored Number	20
The Integrated Answering System	21
Features	21
Answering System Setup	21
Turning the Answering System On/Off	21
Setting the Clock	21
Reviewing Your Time Stamp	22
Setting Your PIN Code	22
Setting Your Outgoing Message (OGM)	23
Selecting a Preset OGM	23
Setting the Toll Saver Switch	24
Using the Reset Button	24
VOX/Calling Party Control Feature	24

Using Your Answering System	25
Playing New Messages	25
Playing Old Messages	25
Repeating a Message	25
Skipping a Message	25
Deleting a Message	26
Deleting All Messages	26
Message Full Indication	26
Leaving a Memo Message	27
Remote Operation	27
Using a Touch-Tone Phone	27
Troubleshooting	28
Telephone Troubleshooting Chart	28
Answering System Troubleshooting Chart	29
Specifications	30

Important Safety Instructions

When using your telephone equipment, these basic safety precautions should always be followed to reduce the risk of fire, electrical shock, and injury to persons:

1. Read and understand all instructions.
2. Follow all warnings and instructions marked on the product.
3. Unplug this product from the wall outlet before cleaning, and use a dry cloth, without liquid or aerosol cleaners.
4. Do not use this product near water; for example, near a bath tub, wash bowl, kitchen sink or laundry tub, in a wet basement, or near a swimming pool.
5. Do not place this product on an unstable cart, stand, or table. The telephone may fall, causing serious damage to the unit.
6. Slots and openings in the cabinet and the back or bottom are provided for ventilation. To protect the product from overheating, these openings must not be blocked or covered. This product should never be placed near or over a radiator or heat register. This product should not be placed in a built-in installation unless proper ventilation is provided.
7. This product should be operated only from the type of power source indicated on the marking label. If you are not sure of the type of power supply to your home, consult your dealer or local power company.
8. Do not allow anything to rest on the power cord. Do not locate this product where the cord will be damaged by persons walking on it.
9. Do not overload wall outlets and extension cords, as this can result in the risk of fire or electrical shock.
10. Never push objects of any kind into this product through cabinet slots, as they may touch dangerous voltage points or short out parts that could result in a risk of fire or electric shock. Never spill liquid of any kind on the product.
11. To reduce the risk of electric shock, do not disassemble this product. Take it to qualified service personnel when service or repair work is required. Opening or removing covers may expose you to dangerous voltages or other risks. Incorrect reassembly can cause electric shock when the appliance is subsequently used.
12. Unplug this product from the wall outlet and refer servicing to qualified service personnel under the following conditions:
 - A. When the power supply cord is damaged or frayed.
 - B. If liquid has been spilled into the product.
 - C. If the product has been exposed to rain or water.
 - D. If the product does not operate normally when following the operating instructions. (Adjust only those controls that are covered by the operating instructions. Improper adjustment of other controls may result in damage and will often require extensive repair work by a qualified technician.)
 - E. If the product has been dropped or the cabinet has been damaged.
 - F. If the product exhibits a distinct change in performance.
13. Do not use the telephone to report a gas leak in the vicinity of the leak.

Battery Safety Precautions

Caution: *To reduce the risk of fire or injury to persons by the battery, read and follow these instructions:*

1. Use only the appropriate type and size Battery Pack specified in this Operating Guide.
2. Do not dispose of the Battery Pack in a fire. The cell may explode. Check the Nickel-Cadmium Battery Disposal package insert for disposal instructions.
3. Do not open or mutilate the Battery Pack. Released electrolyte is corrosive and may cause damage to the eyes or skin. It may be toxic if swallowed.
4. Exercise care in handling the battery in order not to short the battery with conducting materials such as rings, bracelets, and keys. The battery or conductor may overheat and cause burns.
5. Charge the Battery Pack provided with or identified for use with this product only in accordance with the instructions and limitations specified in the instruction manual provided for this product.
6. Observe proper polarity orientation between the Battery Pack and battery charger.

SAVE THESE INSTRUCTIONS

Introduction

Congratulations on your purchase of the XCA550/55 telephone with an integrated digital answering system. This phone is designed to exacting standards to provide reliability, long life, and outstanding performance.

This manual describes the operation of the XCA550 and the XCA555 models.

Features

- 25 46/49 MHz Channels
- Integrated Digital Answering System
- *AutoSecure*[™]
- *Random Code*[™] Digital Security
- Handset Ringer/Volume Controls
- UltraClear Plus
- Pulse/Tone Dialing
- *AutoTalk*[™]
- *AutoStandby*[™]
- 10-Number Memory
- 1-way Page/Find Button
- Redial/Flash Key
- 14 Day Battery Life

AutoTalk[™] allows you to answer a call by just removing the Handset from the Base so you don't have to waste time pushing buttons or flipping switches. *AutoStandby*[™] allows you hang up by simply returning the Handset to the Base.

The *UltraClear Plus* innovative technology, together with 25 different channels, virtually eliminates background noise and provides you with the best possible reception during all of your conversations.

To protect you against misbilled calls which might result from your phone being activated by other equipment, *Random Code*[™] digital security automatically selects one of over 65 thousand digital security codes for the Handset and Base Units. Also, the *AutoSecure*[™] feature electronically locks your phone when the Handset is in the Base.

To get the most from your phone, please read this Operating Guide thoroughly. Also be sure to complete the Product Registration form and mail it in.

**Be sure to visit our Internet site at:
[http://www.uniden.com!](http://www.uniden.com)**

Included with the XCA550/55

If any of these items are missing or damaged, contact Uniden Customer Service at: (800) 297-1023, 8:00 am to 5:00 p.m. Central, Monday through Friday.



Handset

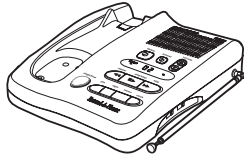

Base Unit

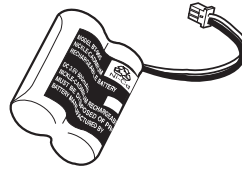

Rechargeable Battery

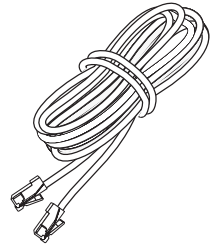

Long Telephone Cord

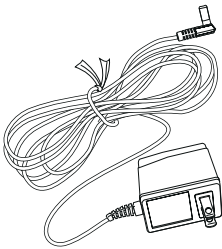

AC Adapter

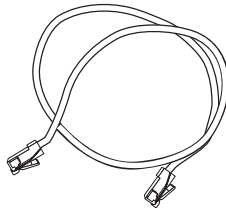

Short Telephone Cord



Operating Guide



Other Printed Material

Important Electrical Considerations

Unplug all electrical appliances when you know an electrical storm is approaching. Lightning can pass through your household wiring and damage any device connected to it. This phone is no exception.

Warning: Please do not attempt to unplug any appliance during an electrical storm.

Caution: Changes or modifications to this product not expressly approved by Uniden, or operation of this product in any way other than as detailed by this Operating Guide, could void your authority to operate this product.

Range

Your new phone is designed to achieve the maximum possible range by transmitting and receiving according to the highest specifications set forth by the FCC. We have rated this phone to operate at a maximum distance with the qualification that the range depends upon the environment in which the telephone is used. Many factors limit range, and it would be impossible to include all the variables in our rating. The Maximum Range rating of this phone is meant to be used as a means of comparison against other range claims.

Telephone Line Problems

The FCC has granted the telephone company the right to disconnect service in the event that your phone causes problems on the telephone line. Also, the telephone company may make changes in facilities and services which may affect the operation of your unit. However, your telephone company must give adequate notice in writing prior to such actions to allow you time for making necessary arrangements to continue uninterrupted service.

If you are having trouble with your telephone service, you must first disconnect your phone to determine if it is the cause of your problem. If you determine that it is the cause, you must leave it disconnected until the trouble has been corrected.

Radio Interference

Radio interference may occasionally cause buzzing and humming in your cordless Handset, or clicking noises in the Base Unit. This interference is caused by external sources such as TV, refrigerator, vacuum cleaner, fluorescent lighting, or electrical storm. Your unit is NOT DEFECTIVE. If these noises continue and are too distracting, please check around your home to see what appliances may be causing the problem. In addition, we recommend that the Base not be plugged into a circuit that also powers a major appliance because of the potential for interference. Be certain that the antenna on the unit is fully extended when needed.

In the unlikely event that you consistently hear other voices or distracting transmissions on your phone, you may be receiving radio signals from another cordless telephone or other source of interference. If you cannot eliminate this type of interference, you need to change to a different channel.

Finally, it should be noted that some cordless telephones operate at frequencies that may cause interference to nearby TVs and VCRs. To minimize or prevent such interference, the base of the cordless telephone should not be placed near or on top of a TV or VCR. If interference is experienced, moving the cordless telephone farther away from the TV or VCR will often reduce or eliminate the interference.

More Than One Cordless Telephone

If you want to use more than one cordless telephone in your home, they must operate on different channels. Press the channel key to select a channel that provides the clearest communication.

Cordless Telephone Privacy

Cordless telephones are radio devices. Communications between the handset and base of your cordless telephone are accomplished by means of radio waves which are broadcast over the open airways. Because of the inherent physical properties of radio waves, your communications can be received by radio receiving devices other than your own cordless telephone unit. Consequently, any communications using your cordless telephone may not be private.

Installation

Selecting a Location

Before choosing a location for your new phone, there are some important guidelines you should consider:

- The location should be close to both a phone jack and continuous power outlet.

Note: *A continuous power outlet is an AC outlet which does not have a switch to interrupt its power.*

- Keep the Base Unit and Handset away from sources of electrical noise such as motors or fluorescent lighting.
- Be sure there is sufficient space to fully extend the Base Unit antenna.
- The Base Unit can be placed on a desk or tabletop or mounted on a standard AT&T or GTE wall plate.
- If you decide to mount your phone on the wall, make sure to change the handset retainer so that the tab which holds the Handset faces up. (See page 12 for more information.)
- You should charge your new phone for 15-20 hours before completing the installation or using the Handset.

Telephone Line Outlets

There are two types of phone outlets:

Modular Jack

Most phone equipment available now uses modular jacks. Phone cords are fitted with a molded plastic connector which plugs into this type of jack. If you do not have modular phone jacks, contact your local telephone company for information about their installation.

Hard-wired Jack

Some equipment is wired directly to a phone jack, and these types of installations require a modular jack converter. This type of installation is not difficult; however, you should contact your Uniden telephone dealer or a telephone supply store for advice about the proper adapter or converter for your particular situation.

Connecting the Telephone Cords

Consider these safety guidelines before connecting the telephone cords:

Caution!

- *Never install telephone wiring during a lightning storm.*
- *Never touch uninsulated telephone wires or terminals unless the telephone line has been disconnected.*
- *Use caution when installing or modifying telephone lines.*

Applying Power to the Base Unit

The XCA550/55 phones require an AC outlet, without a switch to interrupt power, and the included AC adapter. To relieve strain on the DC plug when the phone is placed on a desk or table, connect the adapter as shown below.

Wrap the power cord around the convenient notch on the bottom.

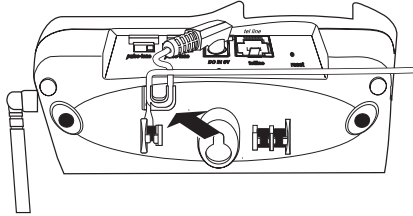

Important: Place the power cord so that it does not create a trip hazard, or where it could become chafed and create a fire or other electrical hazards.

Adapter Safety Feature

The AC adapter furnished with this phone may be equipped with a polarized line plug — a plug having one blade wider than the other. This plug will fit into the power outlet only one way. If you are unable to insert the plug fully into the outlet, try reversing the plug.

- Do not alter the shape of the blades of the polarized plug.
- If you cannot plug the AC adapter into the outlet, contact someone about replacing the outlet.

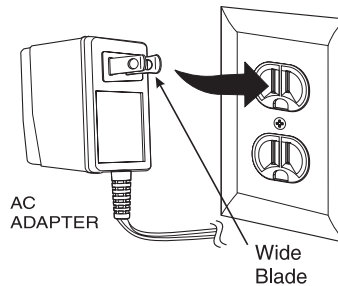

Desk or Tabletop Installation

1. Place the Base on a desk or tabletop.

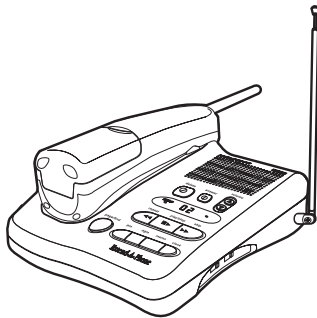

2. Plug the AC Adapter cord into the 9V DC input jack on the Base Unit.

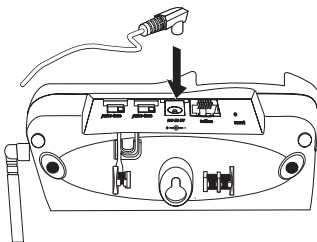

3. Place the AC Adapter cord around the strain relief.

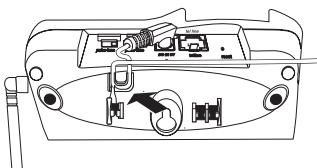

4. Plug one end of the long telephone cord into the TEL LINE jack on the Base Unit.

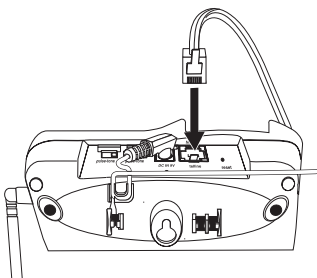

5. Plug the other end of the cord into the telephone jack on the wall.

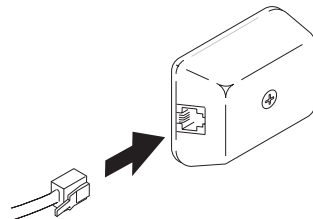

6. Plug the AC Adapter into a standard 120V AC wall outlet.

Note: Do not use an outlet controlled by a wall switch.

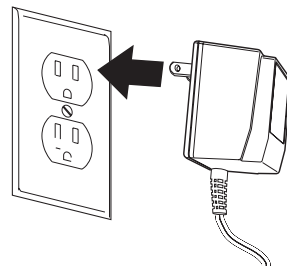

Wall Installation

Standard Wall Plate Mounting

These phones are designed to be mounted on a standard AT&T or GTE wall plate.

1. Plug the AC Adapter into the Base Unit.

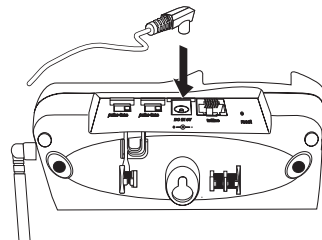

2. Place the AC Adapter cord inside the molded channel.

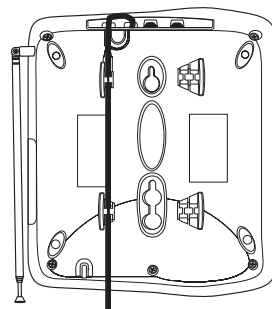

3. Plug one end of the short telephone cord into the **TEL LINE** jack on the Base Unit.

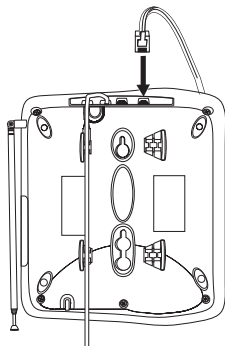

4. Place the telephone cord inside the molded channel on the bottom of the Base Unit. Then plug the other end of the telephone cord into the modular jack on the wall.

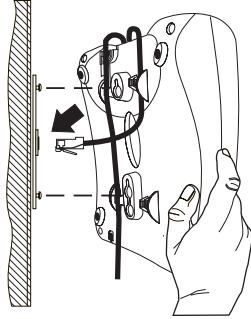

5. Place the Base Unit on the posts of the wall plate and push down until it's firmly seated.

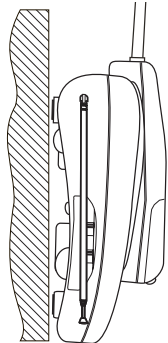

6. Plug the AC Adapter into a standard 120V AC wall outlet. **Note:** Do not use an outlet controlled by a wall switch.

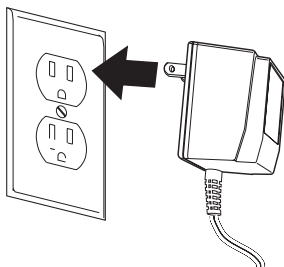

Direct Wall Mounting

If you do not have a standard wall plate, you can mount your phone directly on a wall. Before mounting your phone, consider the following:

- Select a location away from electrical cables, pipes, or other items behind the mounting location that could cause a hazard when inserting screws into the wall.
- Make sure the wall material is capable of supporting the weight of the Base Unit and Handset.
- Use #10 screws with anchoring devices suitable for the wall material where the Base Unit will be placed.

1. Insert two mounting screws $3\frac{15}{16}$ inches apart. Allow about $\frac{3}{16}$ of an inch between the wall and screw heads for mounting the phone.

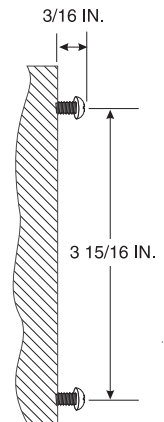

2. Plug the AC Adapter into the Base Unit.

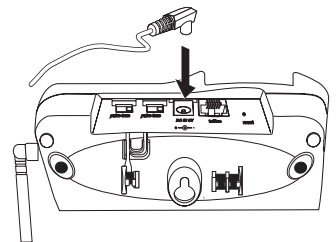

3. Place the AC Adapter cord inside the molded channel.

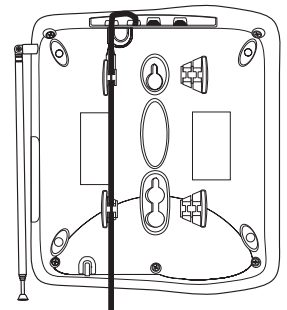

4. Plug one end of the long telephone cord into the **TEL LINE** jack on the Base Unit.

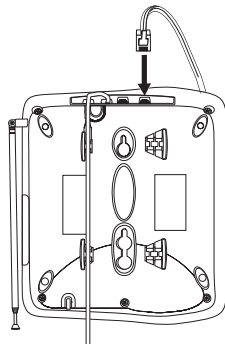

5. Place the cord inside the molded channel on the bottom of the Base Unit.

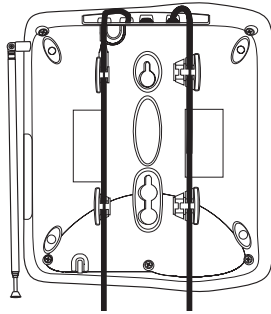

6. Place the Base Unit on the screws and push down until it's firmly seated.

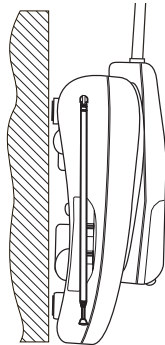

7. Plug the other end of the telephone line cord into the wall jack.

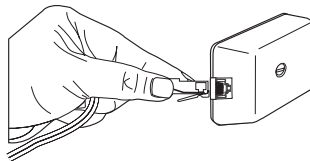

8. Plug the AC Adapter into a standard 120V AC wall outlet.
Note: Do not use an outlet controlled by a wall switch.

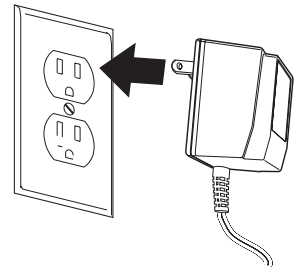

Setting the Handset Retainer

The handset retainer holds the Handset in place if your phone is mounted on a wall. The steps below describe how to remove and replace the retainer so that the tab faces up.

1. Push up on the Handset retainer on the Base Unit, and slide the tab out.

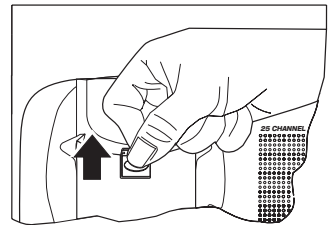

2. Flip the retainer over so the tab faces up.

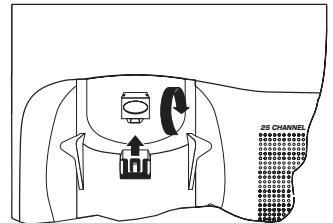

- Put the retainer back into its slot on the Base Unit.

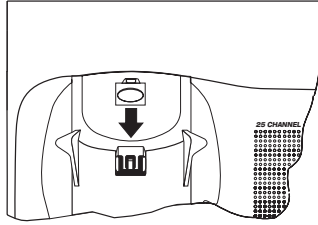

- Push down on the Handset retainer until it snaps into place.

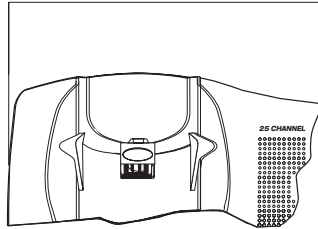

Setting Up Your Phone

Extending the Antenna

Before using your phone, be sure to raise its antenna to the vertical position. Then, fully extend the antenna.

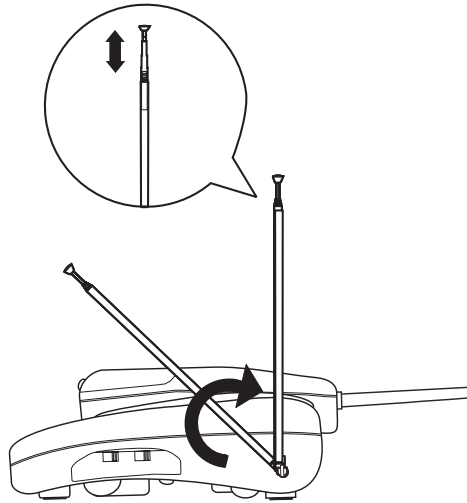

Installing the Handset Battery Pack

1. Press in on the Battery Cover Release.



2. Slide the battery compartment cover down.

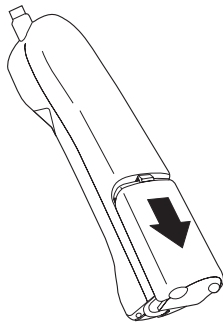

3. Align the plastic connector of the Nickel-Cadmium battery pack with its socket and plug it in.

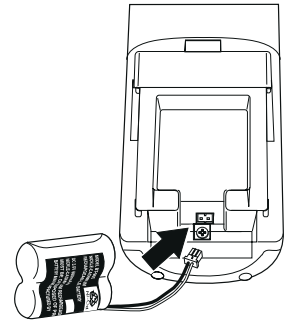

4. Place the battery pack inside the battery compartment, and slide the battery cover back on.

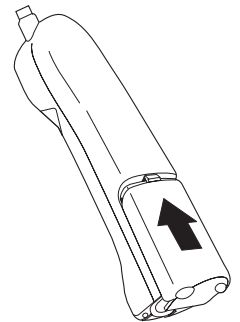

Note: The built-in Memory Backup feature allows up to 3 minutes to disconnect the old battery pack and install a new one without losing any numbers stored in memory.

Cleaning the Battery Contacts

To maintain a good charge, it is important to clean all charging contacts on the Handset and Base Unit about once a month. Use a pencil eraser or other contact cleaner. **Do not** use any liquids or solvents.

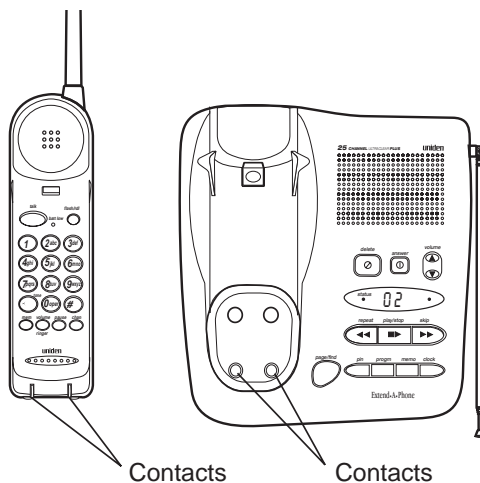

Charging the Battery Pack

Initial Battery Charging

The rechargeable Nickel-Cadmium battery pack must be fully charged before using your phone for the first time. We recommend that the battery pack charge for approximately 15-20 hours, without interruption, before plugging the phone line into your new phone.

1. Place the Handset on the Base Unit. Either place the Handset facedown in the cradle

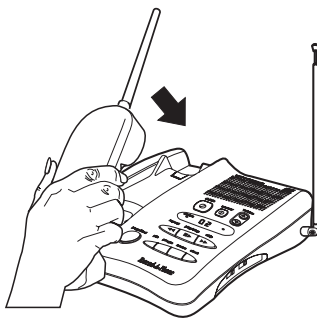

—OR—

Place the Handset in the cradle with it standing on end (desk mount only) .

Note: Make sure to change the Handset Retainer before hanging up the phone (wall mounted bases).

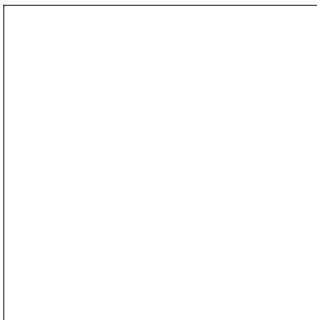

Battery Memory Effect

Rechargeable batteries can develop a “memory” (reduced charge capacity) caused by repeated charge and discharge cycles. The battery life will seem to be shorter every time you use the unit.

To Avoid this Memory Effect

At least once a month, operate the unit until the “Battery Low” indicator begins flashing. Then recharge the battery for a full 15 - 20 hours. Avoid putting the handset back in the base after using the phone for a short time. And, if possible, do not charge the Rechargeable Battery for extended periods of time.

Low Battery Indicator

When the Battery Pack in the Handset is very low and needs to be charged, the **TALK/BATT LOW LED** flashes.

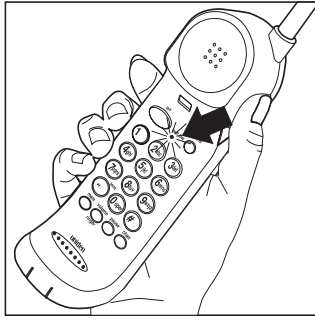

If the **TALK/BATT LOW LED** begins flashing, the phone is programmed to eliminate its functions to save power. The table below describes what to do to return your phone to normal operation.

During a Call	In Standby Mode
Only the talk button operates.	None of the buttons will operate.
The Handset beeps and the TALK/BATT LOW LED flashes once every 3 seconds.	The Handset TALK/BATT LOW LED flashes once every 3 seconds.
Complete your call as quickly as possible.	You will not be able to make a call.
Return the Handset to the Base Unit for charging.	Return the Handset to the Base Unit for charging.

Note: Allow 15 to 20 hours without any interruption for the Handset to fully recharge.

Setting the Pulse/Tone Switch

Be sure the **pulse-tone** switch is in the **tone** position.

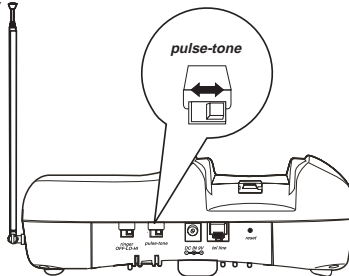

Note: Most phone systems are Tone dialing. Check with your local phone company if you are not sure whether your system is Tone or Pulse dialing.

Setting the Handset Listening Volume

You can choose two different volume settings when using the Handset during a call. When the Handset is first used, the volume will be at its normal setting. However, you can change to a higher volume by pressing **volume** during a call. To return to the normal volume, press **volume** again.

Setting Handset Ringer Volume

You can choose between two different ringer styles, each with a high and low volume. To select the style and volume you like best, press the **ringer** key until you hear the desired setting.

Note: Just remember to select your Handset ringer style and volume when you're not using the phone for a call.

Setting the Base Ringer Volume (XCA555 Only)

To adjust the Base Unit ringer volume, set the **ring vol-off lo hi** switch to the desired setting.

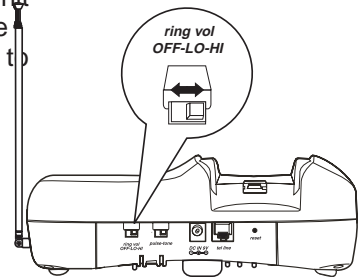

Automatic Digital Code Security

To avoid unauthorized calls on your phone, a Digital Code feature was added to the XCA550/55. This Digital Code is shared only between the Handset and Base Unit. The Code is set *automatically* when you first use the phone.

To change the Digital Code, be sure the Handset is on the Base, then:

1. Remove the Handset from the Base Unit.



2. Press the **page/find** button on the Base Unit.



3. Place the Handset back on the Base Unit while it's still beeping.

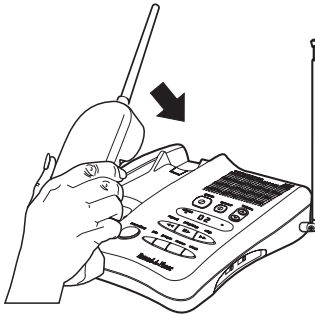

4. When the beeping stops, briefly remove the Handset again, and then return it to the Base Unit.

Note: The **status LED** will blink, indicating the Digital Security Code is set to one of the more than 65,000 codes.

If the Base Unit loses power while the Handset is off the Base, the Digital Code may be erased. When this happens, the Handset will not function. To reestablish the security link between your Handset and Base units:

1. Restore power to the Base Unit.
2. Place the Handset back on the Base Unit.

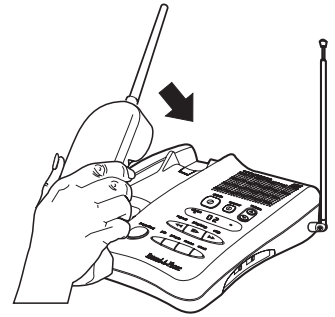



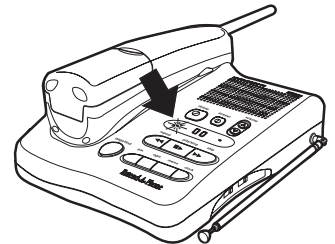





3. The **status LED** will blink, indicating the Digital Security Code is set again.





Using Your Phone

Making and Receiving Calls





The following features of the XCA550/55 phones are different depending on the Handset's location when you make or receive a call.

	Handset On Base	Handset Off Base
Answer Call	Pick up Handset. (AutoTalk)	Press  .
Make Call	<ol style="list-style-type: none"> 1) Pick up Handset. 2) Press . 3) Listen for dial tone. 4) Dial the number. 	<ol style="list-style-type: none"> 1) Press . 2) Listen for dial tone. 3) Dial the number.
Hang up	Return Handset to Base. (AutoStandby)	Press  .
Redial	<ol style="list-style-type: none"> 1) Pick up Handset. 2) Press . 3) Listen for dial tone. 4) Press . 	<ol style="list-style-type: none"> 1) Press . 2) Listen for dial tone. 3) Press .

Note: Sometimes when you press  to hang up the phone, you may get an error tone and the phone will not disconnect. If this happens, place the Handset on the Base Unit or press  again while holding the Handset close to the Base Unit.

Changing Channels, Flash, and Page/Find

To change channels or access call waiting while the phone is in use, or to use the one-way page to locate the Handset, follow these steps:

	Press These Keys	You Will Hear
Changing Channels	Press  . Note: Change channels to help eliminate background noise.	A click similar to when  is pressed. There may be a brief pause as your phone searches for a clear channel.
Flash	<p>If the call waiting tone sounds, press  to accept the waiting call</p> <p>— OR —</p> <p>If you have finished a call and want to make another call, press  to hang up and get a dial tone.</p>	<p>A click, a short pause, then the caller (if you were on a call).</p> <p>— OR —</p> <p>A click, and then a dial tone so you can make a different call.</p>
Page/Find	Press page/find on the Base Unit to locate the Handset	The Handset will beep more than 5 times.

Programming Your Phone

All programming functions must be completed when your phone is in standby because programming keys will not work while you are on the phone.

Storing a Number in Memory

Use these keys to store a number in memory.

Note: An error tone will sound and the programming procedure will be canceled if more than 20 seconds elapse between each keystroke entry or step.

1. Remove the Handset from the Base Unit.

2. Press **mem**.
The **TALK/BATT LOW LED** blinks.

3. Enter the number you want to store (up to 16 digits).



4. If a pause is needed during dialing to access a long distance service, press **pause**.



Note: The **pause** button counts as one digit. Pressing **pause** more than once increases the length of the pause between numbers.

5. Press **mem** again.

6. Enter the memory location (0-9).
A tone indicates that the number is stored.

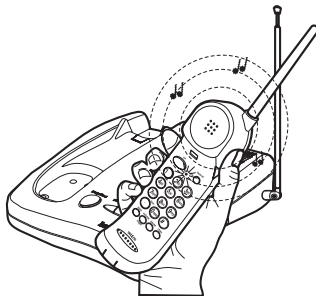

Storing a Mixed Number

If your phone is set up for Pulse dialing, you can store a mixed mode number so that you can easily access long distance services.

Use these keys to store a mixed mode number in memory.

Note: An error tone will sound and the programming procedure will be canceled if more than 20 seconds elapse between each keystroke entry or step.

1. Remove Handset from the Base Unit.

2. Press **mem**.
The **TALK/BATT LOW LED** blinks.

3. Enter the number to be dialed in pulse mode.



4. **tone** on the Handset.

5. Enter the number to be dialed in tone mode.



6. If a pause is needed during dialing to access a long distance service, press **pause**.



Note: The **pause** button counts as one digit. Pressing **pause** more than once increases the length of the pause between numbers.

7. Press **mem** again.

8. Enter the memory location (0-9).
A tone indicates that the number is stored.

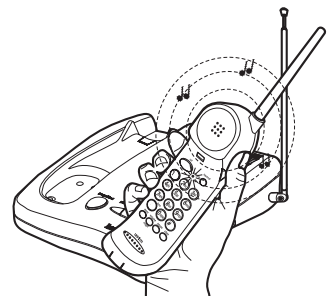

Dialing a Stored Number

To dial a number previously stored in memory, follow these steps:

1. Remove the Handset from the Base Unit.



2. Press **talk**.
3. Press **mem**.
4. Press the memory location number (0-9).

Chain Dialing

On certain occasions, after dialing a number, you may be requested by the party or service you are calling to enter a special access code, such as when performing a banking transaction. To do this, simply:

1. Store the access code into one of the memory numbers.
2. Dial the main number.
3. At the appropriate time, press **mem** followed by the memory location number where the access code is saved.

Erasing a Stored Number

To erase a number previously stored in a memory location (0-9), follow these steps:

1. Remove the Handset from the Base Unit.

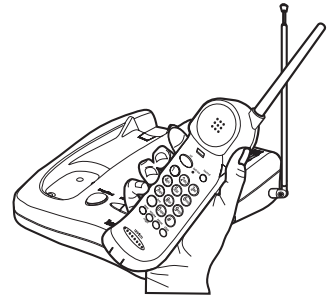

2. Press **mem** twice.
3. Press the memory location number (0-9).

Note: An error tone will sound and the erase procedure will be canceled if more than 20 seconds elapse between each keystroke entry or step.

The Integrated Answering System

The XCA550/55 has a *built-in* Answering System which answers incoming calls and records your messages. You can also use your new Answering System to record a conversation, leave a memo message for someone else who uses the phone, or to announce a special message when you'll be away from your phone.

Features

- Digital Tapeless Recording
- Remote Operation
- Selectable Outgoing Messages
- Built in Flash Memory Backup
- Toll Saver Switch
- 12 Minute Record Time
- Call Screening
- Calling Party Control
- Time and Day Stamp
- Memo Messaging Capability

Digital Tapeless Recording allows you to quickly review your messages, saving or deleting the messages you choose. You'll never have to worry about a tape wearing out or resetting properly.

Your XCA550/55 is an advanced, integrated system which offers you maximum flexibility, but ***please read*** through the sections that explain all of the features before using your Answering System.

Answering System Setup

Turning the Answering System On/Off

1. To turn the Answering System on, press ***answer***.

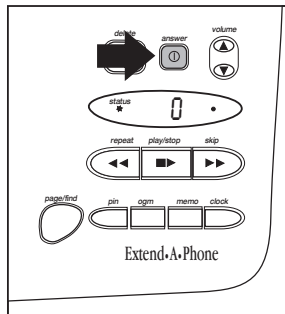

A tone sounds, and the current outgoing message plays on the Base Unit speaker. A second tone sounds to indicate the unit is ready to answer calls, and the Message Counter LED turns on.

2. To turn the Answering System off, press ***answer*** again.

You hear "Answer off." A tone sounds and the Message Counter LED turns off.

Setting the Clock

Each time a message is received, a day and time stamp is added when the message is recorded. To set the correct day and time, follow these steps.

1. Press and hold ***clock*** until you hear a beep.

"The day is announced."

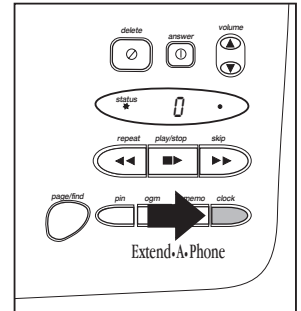

2. Press ***skip/repeat*** until the day you want announces.

You will see a number (0–6) in the display which corresponds to the day.

Day of the Week	Press
Sunday	0
Monday	1
Tuesday	2
Wednesday	3
Thursday	4
Friday	5
Saturday	6

3. Press ***clock***.

"The hour setting is announced."

- Press **skip/repeat** until the current hour setting announces.

You will see the hour (1–12) displayed.

- Press **clock**.

“The minute setting is announced.”

- Press **skip/repeat** until the current minute setting announces.

You will see the minutes (0–59) displayed.

- Press **clock**.

“The AM/PM setting is announced.”

- Press **skip/repeat** until the current AM or PM setting announces.

*You will see an *A* or *P* displayed.*

- Press **clock**.

The time you set is announced.

Reviewing Your Time Stamp

Press **clock**.

The speaker beeps, and the Day and Time Stamp is announced.

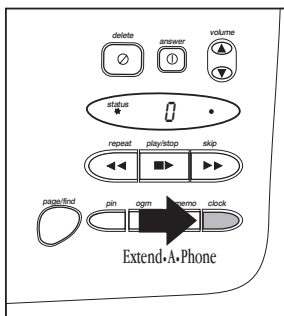

Setting Your PIN Code

You can set a personal two-digit Personal Identification Number (PIN) Code (00 – 99), so you can access your Answering System from a remote location using a touch-tone telephone.

To set a PIN between 1 – 9, follow these steps:

- Press and hold **pin** until you hear a beep.

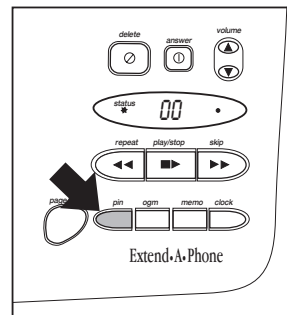

- Press **pin** again.

- Press **skip/repeat** until the PIN number you want displays.

For example, select 02 as your PIN.

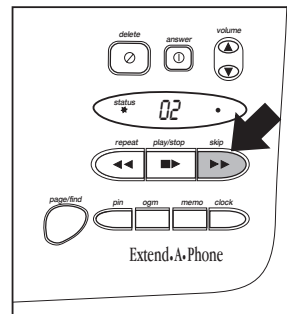

- Press **pin** again.

The PIN you selected is announced.

To set a PIN between 10 – 99, follow these steps:

- Press and hold **pin** until you hear a beep.

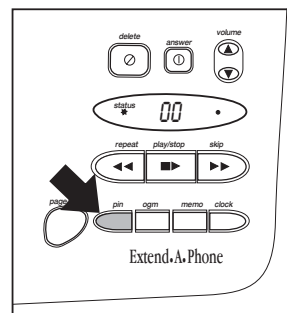

- Press **skip/repeat** until the “tens” place of your PIN displays.

For example, if you want 74 as your PIN, then press skip/repeat until 70 displays.

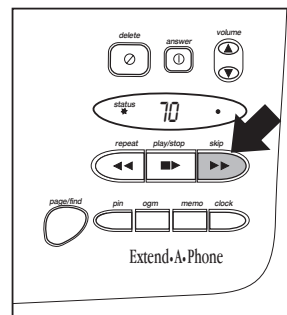

Note: If you select 00, then your PIN will be between 0 – 9. See “To set a PIN between 1 – 9” above.

3. Press **pin** again.
4. Press **skip/repeat** until the “ones” place of your PIN displays.

For example, if you want 74 as your PIN, then press **skip/repeat** until 74 displays.

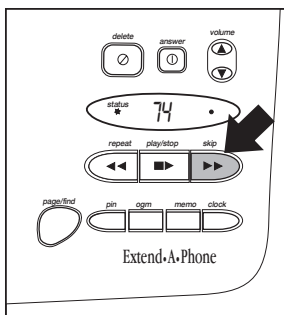

5. Press **pin** again.

The PIN you selected is announced.

Setting Your Outgoing Message (OGM)

When you receive a call, the Answering System answers and automatically plays either a preset message or your personal outgoing message (**ogm**).

Preset Messages

The XCA550/55 has two messages programmed in its memory. If the **rec time ANN/4/1** is set in the announce only position (**ANN**), then the first preset message below plays twice, and no incoming messages are recorded. If you select either the one minute or four minute limit for incoming messages and have not recorded a personal outgoing message, then the second preset message below plays.

- “Hello. No one is available to take your call.”
- “Hello. No one is available to take your call. Please leave a message after the tone.”

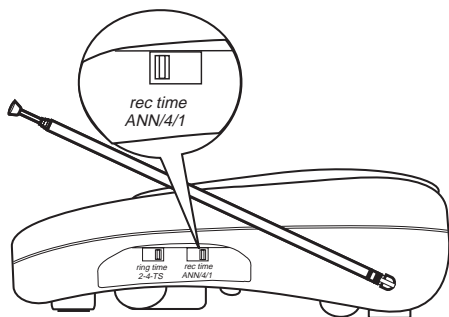

Note: If the **rec time ANN/4/1** switch is in the “Announce Only” position, the Message Counter LED displays an R when the system is in Standby.

Recording Your Personal OGM

1. To record an outgoing message, press and hold **ogm**.

Start recording after the long tone.

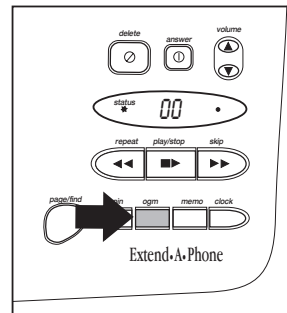

2. Speak clearly while recording your message. When you are finished recording, press **ogm** again.

You will hear a tone, and your message will play on the Base Unit speaker.

Note: You can leave up to a 30-second outgoing message.

Selecting a Preset OGM

After you have recorded an outgoing message, you can set your Answering System to play either a preset message or your outgoing message.

1. Press **ogm**.

Your recorded outgoing message will begin to play.

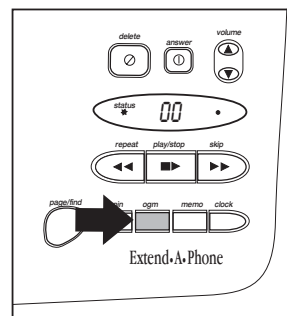

2. While your recorded outgoing message is playing, press **ogm** again.

A tone will sound, and you hear one of the preset messages. After the message plays, and the Answering System automatically returns to Standby.

Note: The message, "Hello. No one is available to take your call" is played if the **rec time ANN/4/1** is set to announce only.

3. To select your recorded message again, press **ogm**.

The preset message will begin to play on the Base Unit speaker.

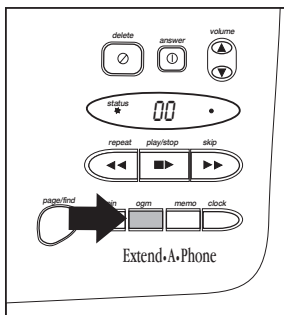

4. While the preset message is playing, press **ogm** again.

A tone will sound, and your recorded message will play. When your message finishes the Answering System automatically returns to Standby.

Setting the Toll Saver Switch

The Ring Time/Toll Saver switch allows you to set the number of rings the caller hears before your Answering System answers. You can set the switch to answer after 2 or 4 rings. In the Toll Saver (TS) position, the Answering System answers after two rings when you have messages recorded, and it answers after four rings if there are no messages. So if you call long distance to check your messages, you can hang up after the second ring and not be billed.

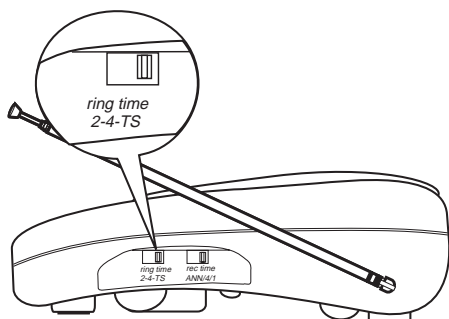

Using the Reset Button

The **reset** button is used to erase all recorded outgoing messages and any messages which are saved in memory. Pressing **reset** does not erase your **PIN** (Personal Identification Number) code or the security code between the Handset and Base Unit.

Press **reset** to delete all stored messages and to erase your personal **ogm**.

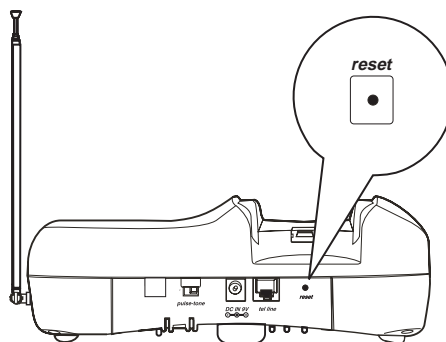

Note: The **reset** button may also be used in the unlikely event that an AC power line disturbance causes the answering system to malfunction and become inoperative.

VOX/Calling Party Control Feature

The Calling Party Control (CPC) feature allows your Answering System to disconnect and reset if the caller hangs up before leaving a message. This prevents your Answering System from using recording time to record a hang up/dial tone message.

Using Your Answering System

Playing New Messages

1. Press **■** to listen to your new messages when the new message counter is flashing.

The time stamp is announced after each message plays, and the Message Counter LED displays the number of the message playing.

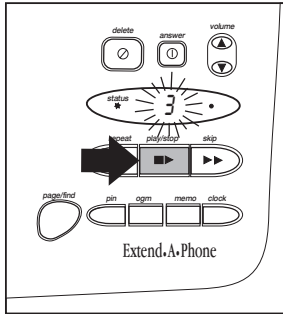

2. When all messages have played, a long tone sounds.
3. The message counter LED stops flashing, indicating that all of the new messages have been reviewed and saved as old messages.

Playing Old Messages

To play your old messages, you must first listen to any new messages. Once you have listened to all new messages, you can review your saved messages.

1. Press **■**.

The first old message begins playing.

The time and day each message was received is announced after the message is played. The Message Counter LED displays the number of the message playing.

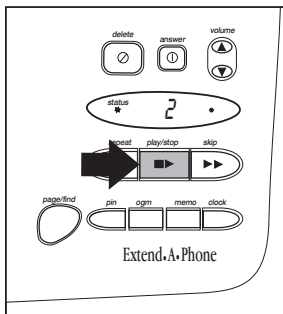

2. Press **play/stop** again at any time to stop listening to your old messages.

Repeating a Message

1. Press **▶** to review your messages.

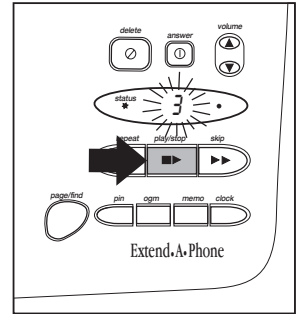

2. Press **◀◀** at anytime to replay a message.

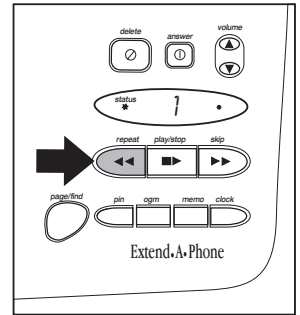

*Pressing **◀◀** during a message returns the system to the beginning of that message. Pressing **◀◀** again before the message replays causes the system to scan back one message. If you have several messages, press **◀◀** until you return to the message you want to replay.*

3. Press **■** at anytime to stop reviewing messages and return to Standby.

Note: *The system will automatically return to Standby if all the messages play.*

Skipping a Message

1. Press **▶** to review your messages.

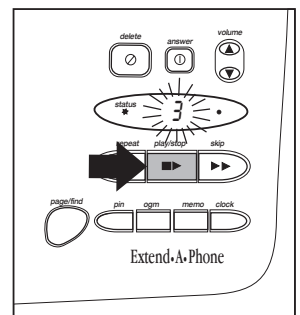

- Press **▶▶** at anytime to skip to the next message.

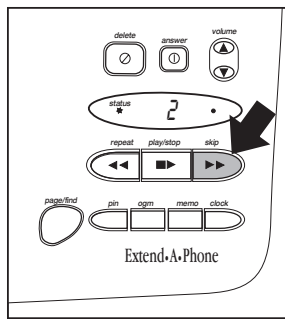

Each time **▶▶** is pressed, the system scans forward one message. If you have several messages, press **▶▶** until you get to the message you want to play.

- Press **■** at anytime to stop reviewing messages and return to Standby.

Note: The system automatically returns to Standby when all messages play.

Deleting a Message

- Press **▶** to review your messages.

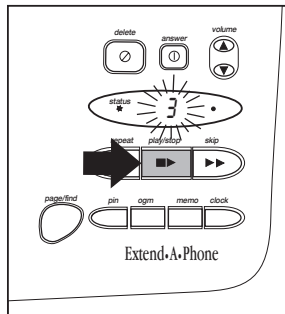

- If you decide to delete a message, press and hold **⓪** anytime during the message.

The system beeps and immediately goes to the next message.

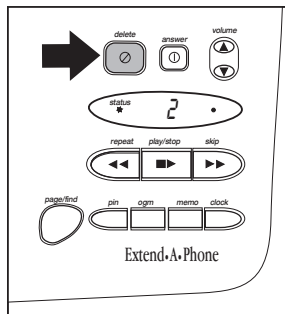

Note: When you press **⓪**, you are deleting the message. Once the message is deleted, it cannot be replayed.

- When all messages have played, a long tone sounds.

Deleting All Messages

You can delete all your messages without deleting each separate message.

- Press and hold **⓪**.

Note: You must review all new messages before using the "Delete All Messages" feature.

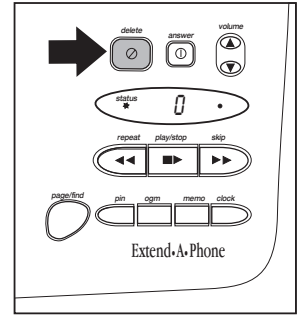

- A long tone sounds once the messages are deleted.

Important: This cannot be undone, so be sure you want to delete all the messages before using the "Delete All Messages" feature.

Message Full Indication

The XCA550/55 has a maximum record time of approximately 12 minutes, or up to 40 incoming messages. When the memory is full, the Answering System will not record incoming calls. To return the system to normal operation, follow these steps.

- When the memory is full, the phone will ring 10 times before the announcement "No remaining time for incoming messages" plays.

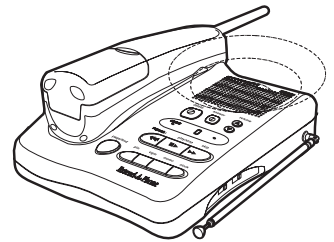

- Delete some or all the of your messages.

Leaving a Memo Message

You can use the XCA550/55 to leave a Memo Message for someone else who uses your Answering System.

To record a memo message, follow these steps:

1. Press and hold **memo** until you hear a long tone, and then release the key.

Two begin flashing in the display.

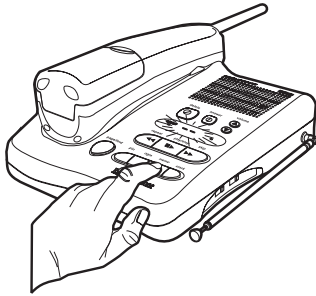

2. Speak into the microphone. When you are finished recording, press **memo** again.

There is a tone, and the Message Counter begins to flash, and the system returns to standby.

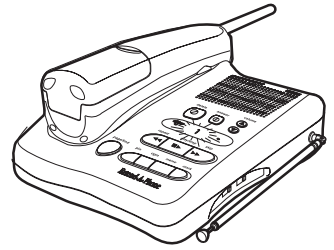

Remote Operation

You can operate your XCA550/55 while you're away from home by calling from any touch-tone phone. When using this feature, remember these important guidelines.

- You should change your Personal Identification Number (**PIN**) before using your Handset. When you first apply power, the code is set to **00**.
- You cannot change the Time and Day Stamp or your **PIN** code from a touch-tone phone.

Using a Touch-Tone Phone

You can operate your Answering System using any touch-tone telephone. Use this function to check for recorded messages, play or delete messages, or even record a new outgoing message.

1. Call your telephone number.

2. During the outgoing message playback, press **#** followed by your **PIN** number.

1	ABC 2	DEF 3
GHI 4	JKL 5	MNO 6
PRS 7	TUV 8	WXY 9
*	OPER 0	#

3. The Answering System announces the Time and Day Stamp followed by the number of messages stored in memory.

4. You then hear intermittent beeps indicating that the system is in the Command Waiting Mode.

Note: You must enter a command within 20 seconds or the Answering System hangs up and returns to Standby.

5. Use this chart to select the function you want.

Function	Press
Repeat	#1
Play	#2
Skip	#3
Delete Message	#4
Answer On/Off	#5
Stop	#6
Record OGM	#7
Play New Message	#8
Replay OGM	#9
Help Menu	#0

6. When you've finished, hang up to exit the system.

Your Answering System automatically returns to Standby.

Troubleshooting

If your XCA550/55 Integrated Telephone Answering Device is not performing to your expectations, please try these simple steps. If you are still unable to resolve the problems, contact Uniden Customer Service at (800) 297-1023, 8:00 a.m. to 5:00 p.m. Central, Monday through Friday.

Telephone Troubleshooting Chart

Problem	Suggestion
Status light won't come on when Handset is placed in Base Unit.	<ul style="list-style-type: none">• Make sure AC Adapter is plugged into the Base Unit and wall outlet.• Make sure Handset is properly seated in Base Unit.• Make sure that the charging contacts on the Handset and Base Unit are clean.
Audio sounds weak and/or scratchy.	<ul style="list-style-type: none">• Make sure that the Base Unit antenna is fully extended and vertical.• Move the Handset and/or Base Unit to different locations and try again.• Press  to select another channel.
Can't make or receive calls.	<ul style="list-style-type: none">• Check both ends of the Base Unit telephone line cord.• Make sure the AC Adapter is plugged into the Base Unit and wall outlet.• Disconnect the AC Adapter for a few minutes, and then reconnect it.
Handset doesn't ring or receive a page.	<ul style="list-style-type: none">• Nickel-Cadmium battery pack may be weak. Charge the battery on the Base Unit for 15–20 hours.• Extend the Base Unit antenna vertically.• The Handset may be too far away from the Base Unit.• Place the Base Unit away from noise sources.• The Digital Security Code may be erased. Set the Digital Code.
Base Unit doesn't ring (XCA555 Only).	<ul style="list-style-type: none">• Set the Base Ringer Switch to lo or hi.

Answering System Troubleshooting Chart

Problem	Suggestion
Answering System does not work.	<ul style="list-style-type: none">• Make sure that the Base Unit is plugged in.• Make sure the Answering System is turned on.• Press the reset button to reset the system after an AC line spike.
Answering System does not answer calls.	<ul style="list-style-type: none">• Set the rec time ANN/4/1 switch in either the 4-minute or 1-minute position.• The memory may be full. Delete some or all of the saved messages.
Messages are incomplete.	<ul style="list-style-type: none">• The incoming messages may be too long. Remind callers to leave a brief message.• The memory may be full. Delete some or all of the saved messages.
No sound on the Base Unit speaker during call monitoring or message playback.	<ul style="list-style-type: none">• Adjust the volume control on the Base Unit.
Cannot access remote call-in features from another touch-tone phone.	<ul style="list-style-type: none">• Make sure you're using the correct PIN number.• Make sure that the touch-tone phone you're using can transmit the tone for at least two seconds. If it cannot, you may have to change to another phone.

Specifications

General – The *DXA1685* complies with FCC Rules, Parts 15 and 68. +

Frequency Control	Phase Locked Loop (PLL) Synthesizer
Modulation	FM
Operating Temperature	– 10° to 50° C

Base Unit

Receive Frequency	48.76 to 49.99 MHz (25 Channels)
Transmit Frequency	43.72 to 46.97 MHz (25 Channels)
Power Requirements	120V AC 60 Hz
Size	7 1/8 in. (W) x 8 in. (D) x 2 1/2 in. (H)
Weight	Approx. 18.9 oz.

Handset

Receive Frequency	43.72 to 46.97 MHz (25 Channels)
Transmit Frequency	48.76 to 49.99 MHz (25 Channels)
Power Requirements	Rechargeable Ni-Cd Battery Pack
Size	7 1/4 in. (H) x 2 1/4 in. (W) x 2 1/4 in. (D) (w/o antenna)
Weight	Approx. 11.7 oz. (including battery)
Battery	BT-185
Capacity	270 mAh, 3.6V
Talk Mode	7 hours
Standby Mode	7 days

Answering System

Memory Type	Digital Tapeless Recording
Memory Capacity	approx. 12 min. (40 messages)
Message Length	1 min. or 4 min. Incoming Message (max.) 30 sec. outgoing message (max.)

Specifications, Features, and availability of Optional Accessories are all subject to change without prior notice.

XCA550/55
Telephone Answering Device

Precautions!

Before you read anything else,
please observe the following:

Warning!

Uniden America Corporation **DOES NOT** represent this unit to be waterproof. To reduce the risk of fire, electrical shock, or damage to the unit, **DO NOT** expose this unit to rain or moisture.

Rechargeable Nickel-Cadmium Battery Warning

- This equipment contains a Rechargeable Nickel-Cadmium Battery.
- Cadmium is a chemical known to the State of California to cause cancer.
- The Rechargeable Nickel-Cadmium Battery contained in this equipment may explode if disposed of in a fire.
- **Do not** short-circuit the battery.
- **Do not** charge the Rechargeable Nickel-Cadmium Battery used in this equipment in any charger other than the one designed to charge this battery as specified in this Guide . Using another charger may damage the battery or cause the battery to explode.

Rechargeable Nickel-Cadmium Batteries must be recycled or disposed of properly!

- Residents of Minnesota should contact 1-800-225-PRBA for information concerning reclamation and disposal of Rechargeable Nickel-Cadmium Batteries.
- Residents outside of Minnesota should contact their local authorities for information concerning reclamation and disposal of Rechargeable Nickel-Cadmium Batteries.



The exclamation point within an equilateral triangle is intended to alert the user to the presence of important operating and maintenance (servicing) instructions in the literature accompanying the appliance.

Controls and Functions (Handset)

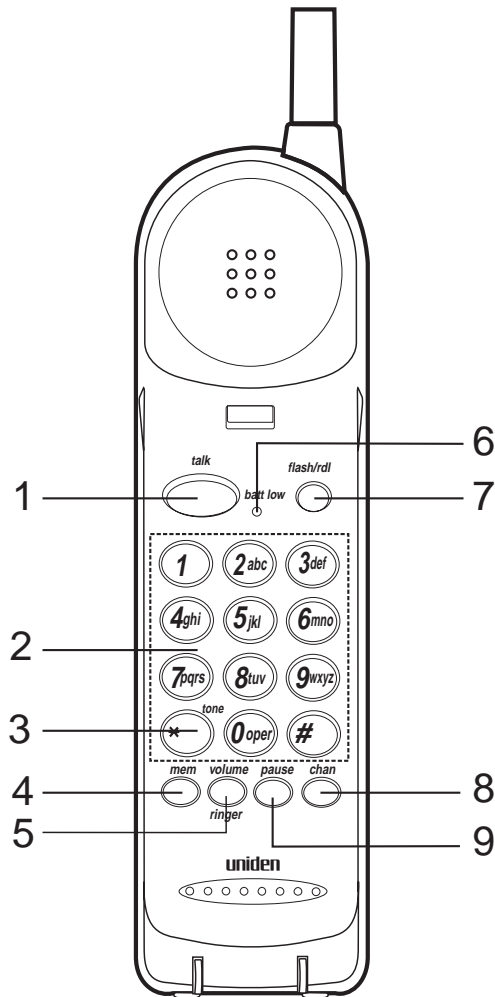

1. Talk Button (*talk*)

2. Numeric Keypad

3. Tone Key (*tone*)

4. Memory Key (*mem*)

5. Ringer Volume (*volume*) / Ringer Key (*ringer*)

6. Talk/Batt Low Indicator

7. Flash (*flash*) / Redial Key (*redial*)

8. Channel Select Key (*chan*)

9. Pause (*pause*)

Controls and Functions (Base)

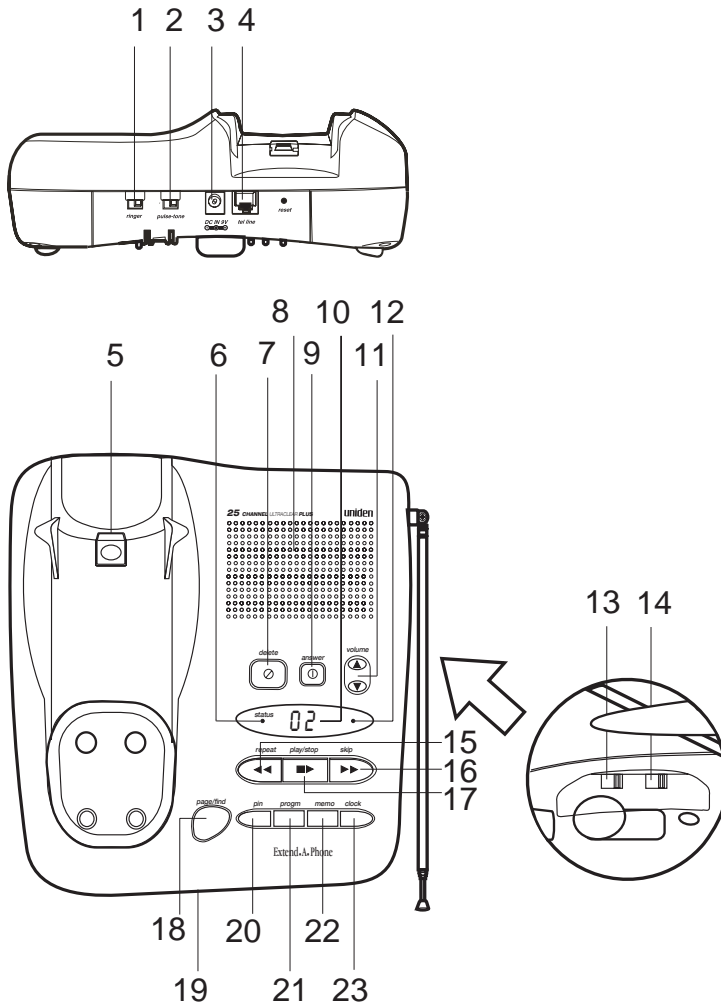

- | | |
|-------------------------------------|-----------------------------|
| 1. Base Ringer Switch (XCA555 Only) | 13. Ring Time 2-4-TS Switch |
| 2. Pulse-Tone Switch | 14. Record Time ANN/4/1 |
| 3. DC Power Jack | 15. Message Repeat Key |
| 4. Telephone Line Jack | 16. Message Skip Key |
| 5. Handset Retainer | 17. Message Play/Stop Key |
| 6. Status Indicator | 18. Page/Find Key |
| 7. Message Delete Key | 19. XCA550/55 Base |
| 8. Speaker | 20. PIN Key |
| 9. Answering System On/Off Key | 21. Outgoing Message Key |
| 10. Message Counter LED | 22. Memo Key |
| 11. Speaker Volume Controls | 23. Clock Announce/Set Key |
| 12. Display | |

One Year Limited Warranty

Important: Evidence of original purchase is required for warranty service.

WARRANTOR: UNIDEN AMERICA CORPORATION ("Uniden")

ELEMENTS OF WARRANTY: Uniden warrants, for one year, to the original retail owner, this Uniden Product to be free from defects in materials and craftsmanship with only the limitations or exclusions set out below.

WARRANTY DURATION: This warranty to the original user shall terminate and be of no further effect 12 months after the date of original retail sale. The warranty is invalid if the Product is (A) damaged or not maintained as reasonable or necessary, (B) modified, altered, or used as part of any conversion kits, subassemblies, or any configurations not sold by Uniden, (C) improperly installed, (D) serviced or repaired by someone other than an authorized Uniden service center for a defect or malfunction covered by this warranty, (E) used in any conjunction with equipment or parts or as part of any system not manufactured by Uniden, or (F) installed or programmed by anyone other than as detailed by the Operating Guide for this product.

STATEMENT OF REMEDY: In the event that the product does not conform to this warranty at any time while this warranty is in effect, warrantor will repair the defect and return it to you without charge for parts, service, or any other cost (except shipping and handling) incurred by warrantor or its representatives in connection with the performance of this warranty. **THE LIMITED WARRANTY SET FORTH ABOVE IS THE SOLE AND ENTIRE WARRANTY PERTAINING TO THE PRODUCT AND IS IN LIEU OF AND EXCLUDES ALL OTHER WARRANTIES OF ANY NATURE WHATSOEVER, WHETHER EXPRESS, IMPLIED OR ARISING BY OPERATION OF LAW, INCLUDING, BUT NOT LIMITED TO ANY IMPLIED WARRANTIES OF MERCHANTABILITY OR FITNESS FOR A PARTICULAR PURPOSE. THIS WARRANTY DOES NOT COVER OR PROVIDE FOR THE REIMBURSEMENT OR PAYMENT OF INCIDENTAL OR CONSEQUENTIAL DAMAGES.** Some states do not allow this exclusion or limitation of incidental or consequential damages so the above limitation or exclusion may not apply to you.

LEGAL REMEDIES: This warranty gives you specific legal rights, and you may also have other rights which vary from state to state. This warranty is void outside the United States of America.

PROCEDURE FOR OBTAINING PERFORMANCE OF WARRANTY: If, after following the instructions in this Operating Guide you are certain that the Product is defective, pack the Product carefully (preferably in its original packaging). Include evidence of original purchase and a note describing the defect that has caused you to return it. The Product should be shipped freight prepaid, by traceable means, or delivered, to warrantor at:

Uniden America Corporation
Parts and Service Division
4700 Amon Carter Boulevard
Fort Worth, TX 76155
(800) 297-1023, 8 AM to 5 PM Central, Monday through Friday

Covered under one or more of the following U.S. patents:

4,511,761

4,595,795

4,797,916

4,523,058

uniden[®]

©1997 Uniden America Corporation. All rights reserved.

Printed in the Philippines.

Free Manuals Download Website

<http://myh66.com>

<http://usermanuals.us>

<http://www.somanuals.com>

<http://www.4manuals.cc>

<http://www.manual-lib.com>

<http://www.404manual.com>

<http://www.luxmanual.com>

<http://aubethermostatmanual.com>

Golf course search by state

<http://golfingnear.com>

Email search by domain

<http://emailbydomain.com>

Auto manuals search

<http://auto.somanuals.com>

TV manuals search

<http://tv.somanuals.com>