

CONTENTS

Controls and Functions	2
Important Safety Instructions	4
Battery Safety Precautions	6
Introduction	7
Features	7
Included with the <i>XCI-660 Series</i>	8
Important Electrical Considerations	9
Range	9
Telephone Line Problems	9
Radio Interference	10
More Than One Cordless Telephone	10
Privacy	10
Installation	11
Selecting a Location	11
Telephone Line Outlets	12
Connecting the Telephone Cords	12
Applying Power to the Base Unit	13
Adapter Safety Feature	13
Desk or Tabletop Installation	14
Wall Installation	16
Direct Wall Mounting	18
Setting Up Your Phone	22
Extending the Antenna	22
Installing the Handset Battery Pack	22
Cleaning the Battery Contacts	24
Charging the Battery Pack	25
Low Battery Indicator	26
Setting the Pulse/Tone Switch	27
Adjusting Ringer Controls	27
Automatic Digital Code Security	28
Entering the Local Area Code	29
Setting Caller ID on Call Waiting	30
Setting the AutoTalk Feature	32
Using Your Phone	34
Making Calls	34
Receiving Calls	35
Redialing the Last Number Called	36
Using the Flash Key with Call Waiting	36
Using Caller ID	38
The Caller ID Display	38
Viewing Calls in Memory	39
Calling the Displayed Number	40
Deleting Caller ID messages	40
Programming Your Phone	41
Storing a Caller ID memory number in Dial Memory	41
Storing a Regular Number in Dial Memory	41
Calling a Number Stored in Memory	43
Editing and Deleting Numbers in Dial Memory	44
Troubleshooting	46

Controls and Functions

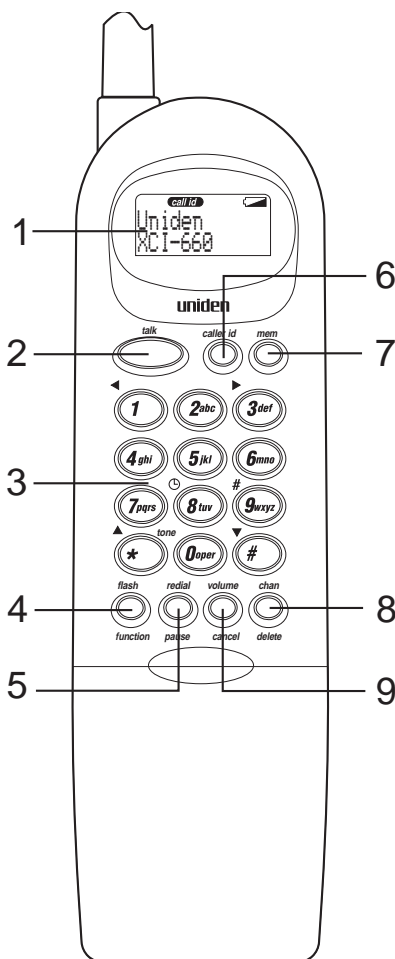
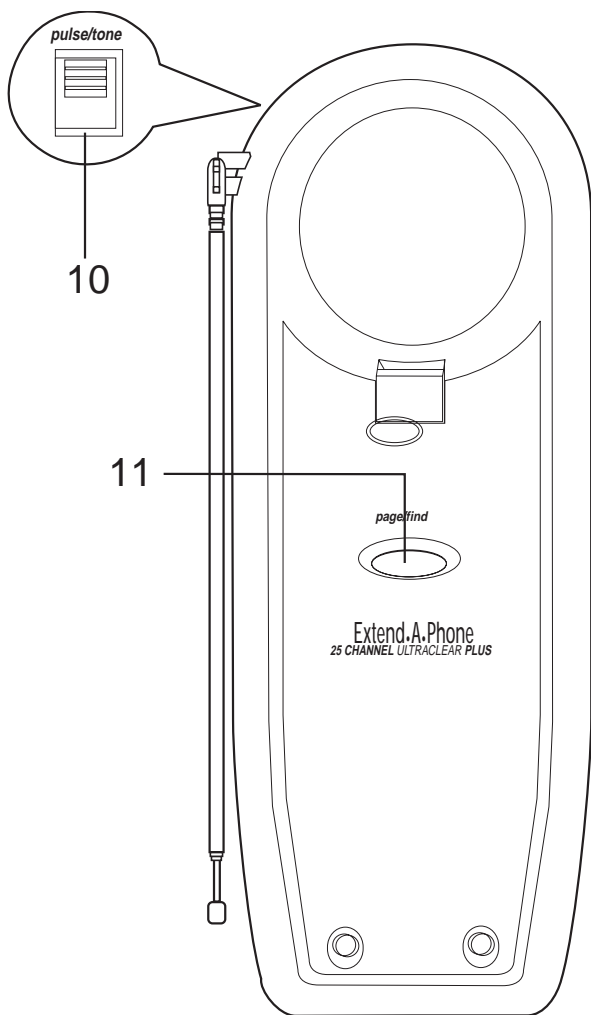

1. LCD Display
2. *talk* Key
3. Numeric Keypad
4. *flash/function* Key
5. *redial/pause* Key
6. *caller id* Key
7. *mem* Key
8. *channel/delete* Key
9. *volume/cancel* Key



10. Pulse/Tone Switch

11. *page/find* Key

Important Safety Instructions

When using your telephone equipment, these basic safety precautions should always be followed to reduce the risk of fire, electrical shock, and injury to persons:

1. Read and understand all instructions.
2. Follow all warnings and instructions marked on the product.
3. Unplug this product from the wall outlet before cleaning, and use a dry cloth, without liquid or aerosol cleaners.
4. Do not use this product near water; for example, near a bath tub, wash bowl, kitchen sink or laundry tub, in a wet basement, or near a swimming pool.
5. Do not place this product on an unstable cart, stand, or table. The telephone may fall, causing serious damage to the unit.
6. Slots and openings in the cabinet and the back or bottom are provided for ventilation. To protect the product from overheating, these openings must not be blocked or covered. This product should never be placed near or over a radiator or heat register. This product should not be placed in a built-in installation unless proper ventilation is provided.
7. This product should be operated only from the type of power source indicated on the marking label. If you are not sure of the type of power supply to your home, consult your dealer or local power company.
8. Do not allow anything to rest on the power cord. Do not locate this product where the cord will be damaged by persons walking on it.
9. Do not overload wall outlets and extension cords, as this can result in the risk of fire or electrical shock.

10. Never push objects of any kind into this product through cabinet slots, as they may touch dangerous voltage points or short out parts that could result in a risk of fire or electric shock. Never spill liquid of any kind on the product.
11. To reduce the risk of electric shock, do not disassemble this product. Take it to qualified service personnel when service or repair work is required. Opening or removing covers may expose you to dangerous voltages or other risks. Incorrect reassembly can cause electric shock when the appliance is subsequently used.
12. Unplug this product from the wall outlet and refer servicing to qualified service personnel under the following conditions:
 - A. When the power supply cord is damaged or frayed.
 - B. If liquid has been spilled into the product.
 - C. If the product has been exposed to rain or water.
 - D. If the product does not operate normally when following the operating instructions. (Adjust only those controls that are covered by the operating instructions. Improper adjustment of other controls may result in damage and will often require extensive repair work by a qualified technician.)
 - E. If the product has been dropped or the cabinet has been damaged.
 - F. If the product exhibits a distinct change in performance.
13. Do not use the telephone to report a gas leak in the vicinity of the leak.

Battery Safety Precautions

Caution: *To reduce the risk of fire or injury to persons by the battery, read and follow these instructions:*

1. Use only the appropriate type and size Battery Pack specified in this Operating Guide.
2. Do not dispose of the Battery Pack in a fire. The cell may explode. Check the Nickel-Cadmium Battery Disposal package insert for disposal instructions.
3. Do not open or mutilate the Battery Pack. Released electrolyte is corrosive and may cause damage to the eyes or skin. It may be toxic if swallowed.
4. Exercise care in handling the battery in order not to short the battery with conducting materials such as rings, bracelets, and keys. The battery or conductor may overheat and cause burns.
5. Charge the Battery Pack provided with or identified for use with this product only in accordance with the instructions and limitations specified in the instruction manual provided for this product.
6. Observe proper polarity orientation between the Battery Pack and battery charger.

SAVE THESE INSTRUCTIONS

Introduction

Congratulations on your purchase of the Uniden *XCI-660 Series* Cordless Telephone. It is designed to exacting standards which provide reliability, long life, and outstanding performance.

This series of phones is available in designer colors which are designated by different model numbers. Accordingly, this manual describes the operation of the *XCI-660*, *XCI-665*, and the *XCI-667*.

Features

- 25 46/49 MHz Channels
- *Random Code™* Digital Security
- *UltraClear Plus*
- *AutoSecure™*
- *AutoStandby™*
- 20-Number Memory
- 30 Number Caller ID Memory
- *Handset Ringer/Volume Controls*
- 1-way Page/Find Button
- *Pulse/Tone Dialing*
- *Redial and Flash Keys*
- 14 Day Battery Life
- *AutoTalk™*
- *Automatic Channel Scanning*

AutoTalk™ allows you to answer a call by just removing the handset from the Base so you don't have to waste time pushing buttons or flipping switches. *AutoStandby™* allows you hang up by simply returning the Handset to the Base.

The *UltraClear Plus* innovative technology, together with 25 different channels, virtually eliminates background noise and provides you with the best possible reception during all of your conversations.

To protect you against misbilled calls which might result from your phone being activated by other equipment, *Random Code™* digital security automatically selects one of over 65 thousand digital security codes for the Handset and Base Units. Also, the *AutoSecure™* feature electronically locks your phone when the Handset is in the Base.

To get the most from your phone, please read this Operating Guide thoroughly. Also be sure to complete the Product Registration form and mail it in.

Included with the *XCI-660 Series*

*If any of these items are missing or damaged,
contact the Uniden Parts Department at:
(800) 554-3988, 8:00 am to 5:00 pm Central,
Monday through Friday.*

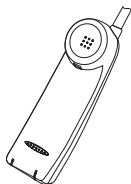

Handset



Base Unit

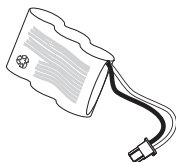

Rechargeable
Battery

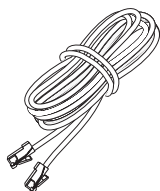

Long
Telephone Cord

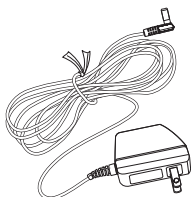

AC Adapter



Short
Telephone Cord

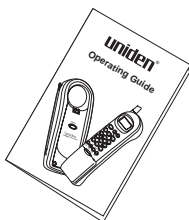

Operating Guide



Other Printed
Material

Important Electrical Considerations

Unplug all electrical appliances when you know an electrical storm is approaching. Lightning can pass through your household wiring and damage any device connected to it. This phone is no exception.

Warning: *Please do not attempt to unplug any appliance during an electrical storm.*

Caution: *Changes or modifications to this product not expressly approved by Uniden, or operation of this product in any way other than as detailed by this Operating Guide, could void your authority to operate this product.*

Range

Your new phone is designed to achieve the maximum possible range by transmitting and receiving according to the highest specifications set forth by the FCC. We have rated this phone to operate at a maximum distance with the qualification that the range depends upon the environment in which the telephone is used. Many factors limit range, and it would be impossible to include all the variables in our rating. The Maximum Range rating of this phone is meant to be used as a means of comparison against other range claims.

Telephone Line Problems

The FCC has granted the telephone company the right to disconnect service in the event that your phone causes problems on the telephone line. Also, the telephone company may make changes in facilities and services which may affect the operation of your unit. However, your telephone company must give adequate notice in writing prior to such actions to allow you time for making necessary arrangements to continue uninterrupted service.

If you are having trouble with your telephone service, you must first disconnect your phone to determine if it is the cause of your problem. If you determine that it is the cause, you must leave it disconnected until the trouble has been corrected.

Radio Interference

Radio interference may occasionally cause buzzing and humming in your cordless Handset, or clicking noises in the Base Unit. This interference is caused by external sources such as TV, refrigerator, vacuum cleaner, fluorescent lighting, or electrical storm. Your unit is NOT DEFECTIVE. If these noises continue and are too distracting, please check around your home to see what appliances may be causing the problem. In addition, we recommend that the Base not be plugged into a circuit that also powers a major appliance because of the potential for interference. Be certain that the antenna on the unit is fully extended when needed.

In the unlikely event that you consistently hear other voices or distracting transmissions on your phone, you may be receiving radio signals from another cordless telephone or other source of interference. If you cannot eliminate this type of interference, you need to change to a different channel.

Finally, it should be noted that some cordless telephones operate at frequencies that may cause interference to nearby TVs and VCRs. To minimize or prevent such interference, the base of the cordless telephone should not be placed near or on top of a TV or VCR. If interference is experienced, moving the cordless telephone farther away from the TV or VCR will often reduce or eliminate the interference.

More Than One Cordless Telephone

If you want to use more than one cordless telephone in your home, they must operate on different channels. Press the channel key to select a channel that provides the clearest communication.

Privacy

Cordless telephones are radio devices. Communications between the Handset and Base Unit of your cordless telephone are accomplished by means of radio waves which are broadcast over the open airways. Because of the inherent physical properties of radio waves, your communications can be received by radio receiving devices other than your own cordless telephone unit. Consequently, any communications using your cordless telephone may not be private .

Installation

Selecting a Location

Before choosing a location for your new phone, there are some important guidelines you should consider:

- The location should be close to both a phone jack and continuous power outlet.

Note: *A continuous power outlet is an AC outlet which does not have a switch to interrupt its power.*

- Keep the Base Unit and Handset away from sources of electrical noise such as motors or fluorescent lighting.
- Be sure there is sufficient space to fully extend the Base Unit antenna.
- The Base Unit can be placed on a desk or tabletop or mounted on a standard AT&T or GTE wall plate.
- If you decide to mount your phone on the wall, make sure to change the handset retainer so that the tab which holds the Handset faces up. (See page 20 for more information.)
- You should charge your new phone for 15-20 hours before completing the installation or using the Handset.

Telephone Line Outlets

There are two types of phone outlets:

Modular Jack

Most phone equipment available now uses modular jacks. Phone cords are fitted with a molded plastic connector which plugs into this type of jack. If you do not have modular phone jacks, contact your local telephone company for information about their installation.

Hard-wired Jack

Some equipment is wired directly to a phone jack, and these types of installations require a modular jack converter. This type of installation is not difficult; however, you should contact your Uniden telephone dealer or a telephone supply store for advice about the proper adapter or converter for your particular situation.

Connecting the Telephone Cords

Consider these safety guidelines before connecting the telephone cords:

CAUTION:

- Never install telephone wiring during a lightning storm.
- Never touch uninsulated telephone wires or terminals unless the telephone line has been disconnected.
- Use caution when installing or modifying telephone lines.

Applying Power to the Base Unit

The *XCI-660 Series* phone requires an AC outlet, without a switch to interrupt power, and the included AC adapter. To relieve strain on the DC plug when the phone is placed on a desk or table, connect the adapter as shown below.

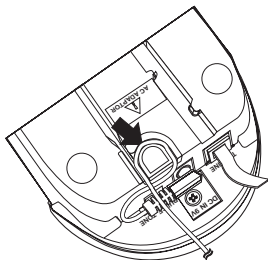

Wrap the power cord around the convenient notch on the bottom.

Important: Place the power cord so that it does not create a trip hazard, or where it could become chafed and create a fire or other electrical hazards.

Adapter Safety Feature

The AC adapter furnished with this phone may be equipped with a polarized line plug — a plug having one blade wider than the other. This plug will fit into the power outlet only one way. If you are unable to insert the plug fully into the outlet, try reversing the plug.

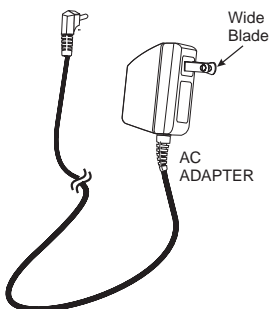

Do not alter the shape of the blades of the polarized plug.

Desk or Tabletop Installation

1. Place the Base on a desk or tabletop.

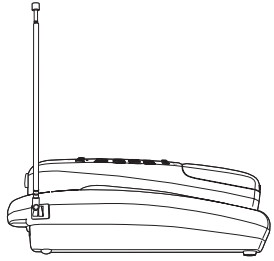

2. Plug the AC Adapter cord into the 9V DC input jack on the Base Unit.

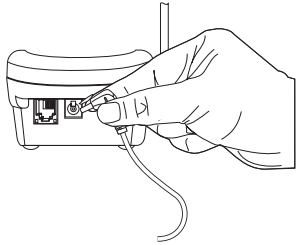

3. Place the AC Adapter cord around the strain relief.

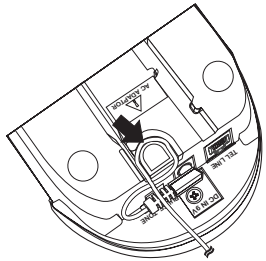

4. Plug one end of the long telephone cord into the **TEL LINE** jack on the Base Unit.

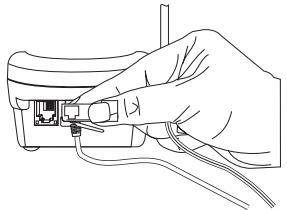

5. Plug the other end of the cord into the telephone jack on the wall.

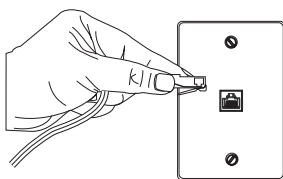

6. Plug the AC Adapter into a standard 120V AC wall outlet.

Note: Do not use an outlet controlled by a wall switch.

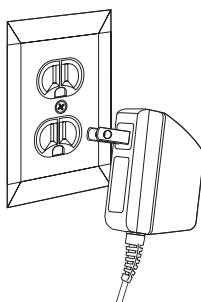

Use only the Uniden AC Adapter supplied with this phone.

Wall Installation

Standard Wall Plate Mounting

These phones are designed to be mounted on a standard AT&T or GTE wall plate.

1. Plug the AC Adapter into the Base Unit.

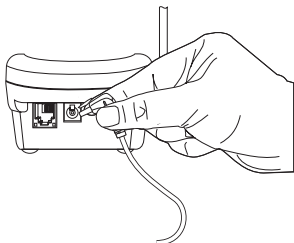

2. Place the AC Adapter cord inside the molded channel.

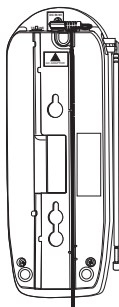

3. Plug one end of the short telephone cord into the **TEL LINE** jack on the Base Unit.

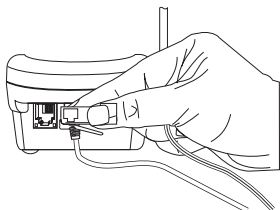

4. Place the telephone cord inside the molded channel on the bottom of the Base Unit.

Then plug the other end of the telephone cord into the modular jack on the wall.

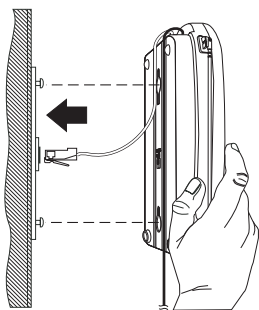

5. Place the Base Unit on the posts of the wall plate and push down until it's firmly seated.

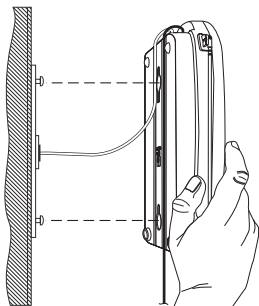

6. Plug the AC Adapter into a standard 120V AC wall outlet.

Note: Do not use an outlet controlled by a wall switch.

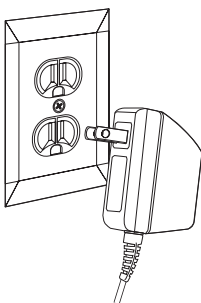

Direct Wall Mounting

If you do not have a standard wall plate, you can mount your phone directly on a wall. Before mounting your phone, consider the following:

- Select a location away from electrical cables, pipes, or other items behind the mounting location that could cause a hazard when inserting screws into the wall.
 - Make sure the wall material is capable of supporting the weight of the Base Unit and Handset.
 - Use #10 screws with anchoring devices suitable for the wall material where the Base Unit will be placed.
1. Insert two mounting screws $3\frac{15}{16}$ inches apart. Allow about $\frac{3}{16}$ of an inch between the wall and screw heads for mounting the phone.

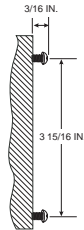

2. Plug the AC Adapter into the Base Unit.

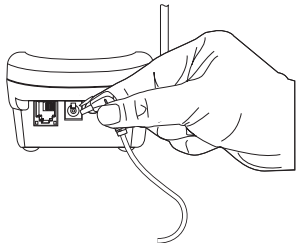

3. Place the AC Adapter cord inside the molded channel.

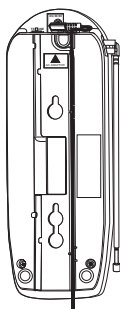

4. Plug one end of the long telephone cord into the **TEL LINE** jack on the Base Unit.

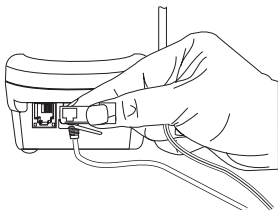

5. Place the cord inside the molded channel on the bottom of the Base Unit.

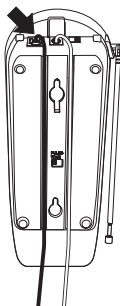

6. Place the Base Unit on the screws and push down until it's firmly seated.

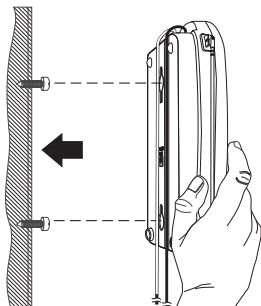

7. Plug the other end of the telephone line cord into the wall jack.

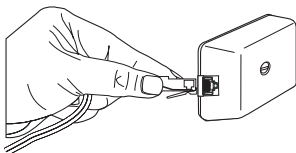

8. Plug the AC Adapter into a standard 120V AC wall outlet.

Note: Do not use an outlet controlled by a wall switch.

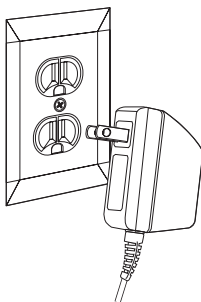

Setting the Handset Retainer

The handset retainer holds the Handset in place if your phone is mounted on a wall. The steps below describe how to remove and replace the retainer so that the tab faces up.

1. Push up on the Handset retainer on the Base Unit, and slide the tab out.

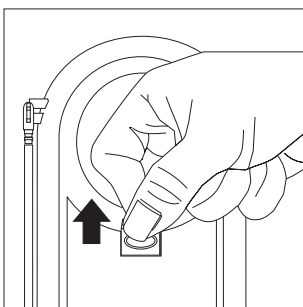

2. Flip the retainer over so the tab faces up.

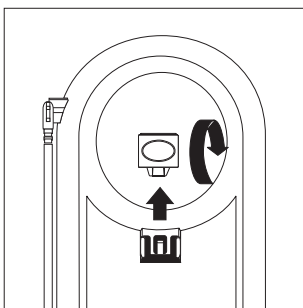

3. Put the retainer back into its slot on the Base Unit.

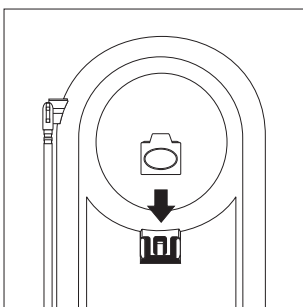

4. Push down on the Handset retainer until it snaps into place.

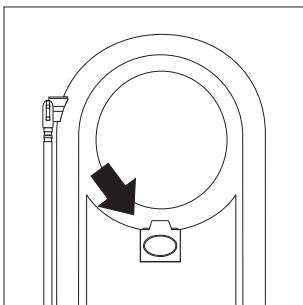

Setting Up Your Phone

Extending the Antenna

Before using your phone, be sure to raise its antenna to the vertical position.

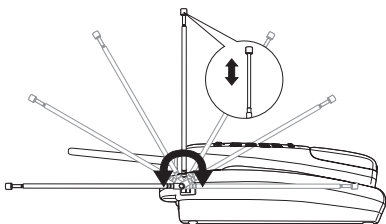

Installing the Handset Battery Pack

1. Press in on the Battery Cover Release.

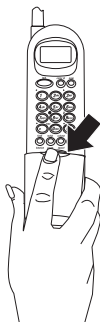

2. Slide the battery compartment cover down.

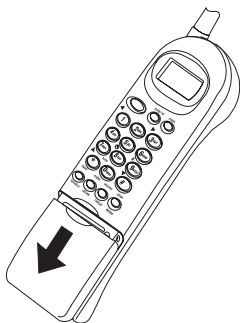

3. Align the plastic connector of the Nickel-Cadmium battery pack with its socket and plug it in.

Note: *The black lead will be on the left when the plug is properly aligned.*

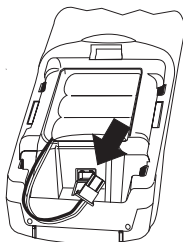

4. Place the battery pack inside the battery compartment, and slide the battery cover back on.

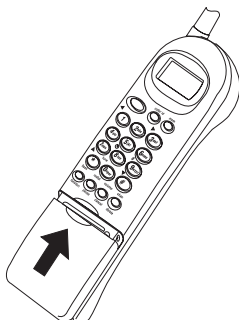

* *The built-in Memory Backup feature allows up to 3 minutes to disconnect the old battery pack and install a new one without losing any numbers stored in memory.*

Cleaning the Battery Contacts

To maintain a good charge, it is important to clean all charging contacts on the Handset and Base Unit about once a month. Use a pencil eraser or other contact cleaner. **Do not** use any liquids or solvents.

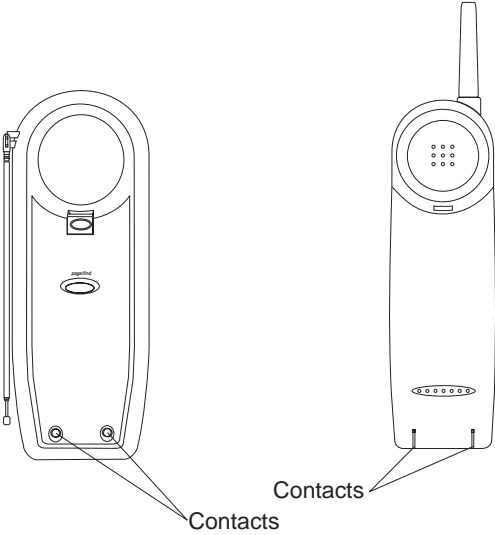

Charging the Battery Pack

Initial Battery Charging

The rechargeable Nickel-Cadmium battery pack must be fully charged before using your phone for the first time. We recommend that the battery pack charge for approximately 15-20 hours, without interruption, before plugging the phone line into your new phone.

1. Place the Handset on the Base Unit. Either place the Handset facedown

— OR —

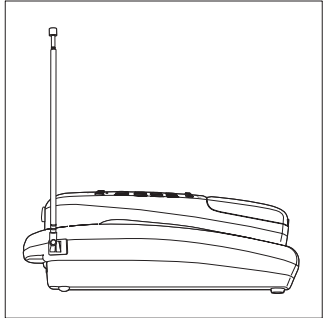

Hang the Handset on the cradle when the phone is mounted on a wall.

Note: Make sure to change the Handset Retainer before hanging up the phone.



2. Make sure the Battery icon lights. If the icon doesn't light, check to see that the AC adapter is plugged in, and that the Handset is making good contact with the Base Unit charging contacts.

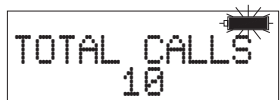

Continuous Battery Charging

For the best battery performance, return the Handset to the Base Unit at the end of the day. This keeps the battery fully charged, so your phone works best.

Low Battery Indicator

When the Battery Pack in the Handset is very low and needs to be charged, the Battery icon flashes.

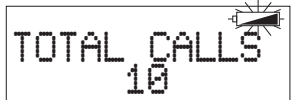

If the Battery icon begins to flash, the phone is programmed to eliminate its functions to save power. The table below describes what to do to return your phone to normal operation.

During a Call	In Standby Mode
Only the TALK button operates.	None of the buttons will operate.
The Handset beeps and the Battery icon flashes once every 3 seconds.	The Handset beeps and the Battery icon flashes once every 3 seconds.
Complete your call as quickly as possible.	You will not be able to make a call.
Return the Handset to the Base Unit for charging.	Return the Handset to the Base Unit for charging.

* Allow 15 to 20 hours without any interruption for the Handset to fully recharge.

Setting the Pulse/Tone Switch

Be sure the **PULSE/TONE** switch is in the **TONE** position.

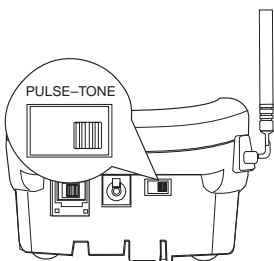

- * *Most phone systems are Tone dialing. Check with your local phone company if you are not sure whether your system is Tone or Pulse dialing.*

Adjusting Ringer Controls

- * *Please refer to the foldout in front of your operating guide for key positions.*

To adjust the ringer volume of your Handset, press **volume/cancel** until you hear the desired ringer tone and volume.

Ring Type A
High

Two-tone High

Ring Type A
Low

Two-tone Low

Ring Type B
High

Three-tone High

Ring Type B
Low

Three-tone Low

To adjust the receiver volume, press **volume/cancel** while you are on a call.

talk
VOLUME HIGH

talk
VOLUME LOW

Automatic Digital Code Security

To avoid unauthorized calls on your phone, a Digital Code feature was added to the **XCI-660 Series** phone. This Digital Code is shared only between the Handset and Base Unit. The Code is set *automatically* when you first use the phone.

* Please refer to the foldout in front of your operating guide for key positions.

To change the Digital Code, be sure the Handset is on the Base, then:

1. Remove the Handset from the Base Unit.
2. Press the **page/find** button on the Base Unit.

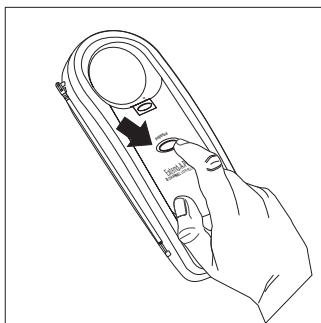

3. Place the Handset back on the Base Unit while it's still beeping.

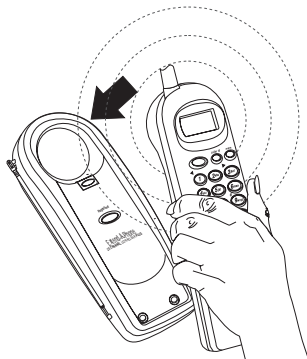

4. When the beeping stops, briefly remove the Handset again, and then return it to the Base Unit.
5. The Battery icon will blink to indicate that the Digital Security Code is set to one of the more than 65,000 codes.

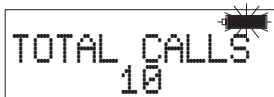

- * *If the Base Unit loses power while the Handset is off the Base, the Digital Code may be erased. When this happens, the Handset will not function.*

To reestablish communication between the Handset and Base Unit:

1. Restore power to the Base Unit.
2. Place the Handset back on the Base Unit.
3. The Battery icon will blink to indicate that the Digital Security Code is set.

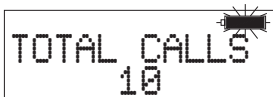

Entering the Local Area Code

- * *Please refer to the foldout in front of your operating guide for key positions.*

You must enter your local area code for the Caller ID redial features to work properly.

To enter your local area code:

1. Remove the Handset from the Base Unit.

2. Press flash/function twice.



3. Enter your local area code. For example, 817.



4. Press mem. A confirmation tone sounds and the display remains on for two seconds.



5. Place the Handset on the Base. The Battery icon will blink to indicate that the area code is stored.

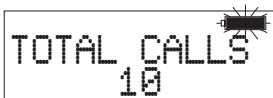

To delete your local area code:

1. Remove the Handset from the Base Unit.
2. Press **flash/function** twice.



3. Press **chan/delete** three times.



4. Press **mem**. A confirmation tone sounds and the display remains on for two seconds.



5. Place the Handset on the Base. The Battery icon will blink to indicate that the setting is stored.

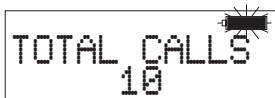

Setting Caller ID on Call Waiting

- * *You must subscribe to caller id on call waiting from your local phone service to use this feature.*

You can set your **XCI-660 Series** phone to display information about calls that generate a call waiting tone while you are on a call.

- * *With this feature set you will not be able to hear the person you are talking to for 2.4 seconds after you receive the call waiting tone.*

To turn Caller ID on Call Waiting on:

1. Remove the Handset from the Base Unit.
2. Press **flash/function** three times.

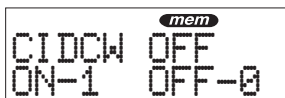

3. Press **1**.

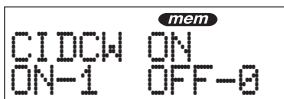

4. Press **mem**. A confirmation tone sounds and the display remains on for two seconds.



5. Place the Handset on the Base. The Battery icon will blink to indicate that the setting has been stored.

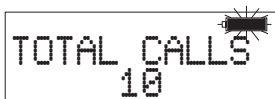

To turn Caller ID on Call Waiting off:

1. Remove the Handset from the Base Unit.
2. Press **flash/function** three times

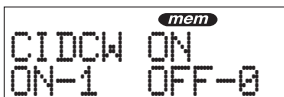

3. Press **0**.

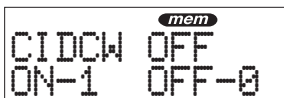

4. Press **mem**. A confirmation tone sounds and the display remains on for two seconds.

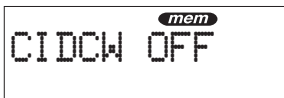

5. Place the Handset on the Base. The Battery icon will blink to indicate that the setting has been stored.

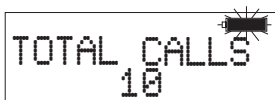

Setting the AutoTalk Feature

To turn AutoTalk on:

1. Remove the Handset from the Base Unit.
2. Press **flash/function** four times.



AUTOTALK OFF
ON-1 OFF-0

3. Press **1**.



AUTOTALK ON
ON-1 OFF-0

4. Press **mem**. A confirmation tone sounds and the display remains on for two seconds.



AUTOTALK ON

5. Place the Handset on the Base. The Battery icon will blink to indicate that the setting has been stored.

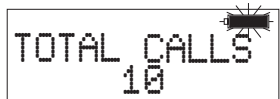

TOTAL CALLS
10

To turn AutoTalk off:

1. Remove the Handset from the Base Unit.
2. Press **flash/function** four times.



AUTOTALK ON
ON-1 OFF-0

3. Press **0**.



AUTOTALK OFF
ON-1 OFF-0

4. Press **mem**. A confirmation tone sounds and the display remains on for two seconds.



AUTOTALK OFF

5. Place the Handset on the Base. The Battery icon will blink to indicate that the setting has been stored.

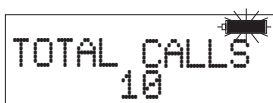

Using Your Phone

- * Please refer to the foldout in front of your operating guide for key positions.

Making Calls

1. Remove the Handset from the Base Unit.
2. Dial the number you wish to call. For example, **123-4567**

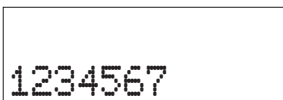

3. If you entered a wrong number, press **chan/delete** to backspace until the number is erased.

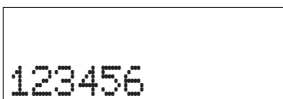

To cancel making the call, press **volume/cancel**.



4. Press **talk**.

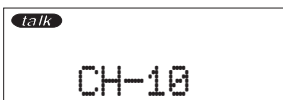

- * If the Handset fails to connect with the Base the Handset beeps and returns to standby mode.

5. During your conversation the LCD displays the call timer.

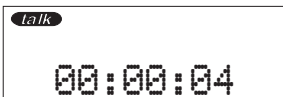

When you are finished with the conversation, press **talk** to hang up.

— OR —

Place the Handset back on the Base.

Receiving Calls

- * You must subscribe to Caller ID services from your local phone company for the caller's name and number to be displayed.

When the phone rings, the LCD displays information about the person calling you.



KATHLEEN ROL
817-858-3333

— OR —

If the signal is not strong enough to display the complete ID, the LCD may display:



KATHLEEN ROL
817- - -3333

— OR —

If no caller ID signal is present the LCD displays:



CALLING

Answering a Call with AutoTalk Enabled

If you have enabled the AutoTalk feature, just remove the Handset from the Base to answer an incoming call. See "Setting the AutoTalk Feature" on page 30 for details on setting AutoTalk.

Answering a Call without AutoTalk Enabled

1. When the phone rings, pick up the Handset and press **talk**. The channel number is displayed for 2 seconds.

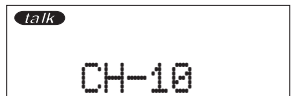

talk
CH-10

During your conversation the LCD displays the call timer.

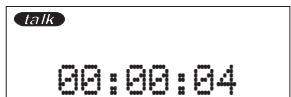

talk
00:00:04

When you are finished with the conversation, press **talk** to hang up.

— OR —

Place the Handset back on the Base.

Redialing the Last Number Called

1. Remove the Handset from the Base Unit.
2. Press **talk**.

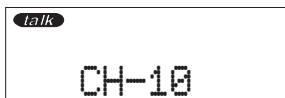

- * *If the Handset fails to connect with the Base the Handset beeps and returns to standby mode.*

3. Press **redial/pause**.

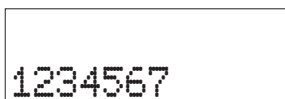

- * *If the last number dialed is longer than 12 digits, the display will scroll to the left until the last number is shown in the display.*

4. During your conversation the LCD displays the call timer.

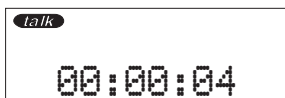

When you are finished with the conversation, press **talk** to hang up.

— OR —

Place the Handset back on the Base.

Using the Flash Key with Call Waiting

- * *You must subscribe to call waiting service from your local phone company to use this feature.*

1. While talking you hear the call waiting signal.

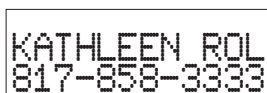

2. Press ***flash/function*** to switch to that call.

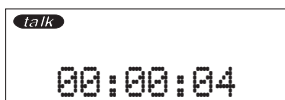

3. To switch back to your original call, press ***flash/function*** again.

Using Caller ID

The Caller ID Display

The LCD displays information about the current call and previous calls received on your **XCI-660 Series** cordless phone, including the total calls received, and the number of new calls received.

The LCD display is always active while the Handset is on the Base. While the Handset is off the Base, the LCD display remains on for two minutes before turning off. To reactivate the LCD, you need to press the *caller id* key.

LCD with Handset on Base

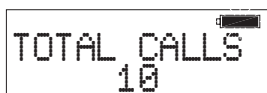

NO NEW CALLS

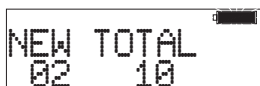

WITH NEW CALLS

LCD with Handset off Base and *caller id* Pressed.



NO NEW CALLS



WITH NEW CALLS

- * *The XCI-660 Series can store information on up to 30 different calls. Information on new calls received after 30 calls will be stored, and the oldest call in memory will be deleted.*

Viewing Calls in Memory

1. Remove the Handset from the Base Unit.
2. Press *caller id*.



3. To view calls stored in memory, Press the ▼ or ▲ keys.



To dial the number currently displayed, press the *talk* key.

To add a **1** for long distance dialing, press **1** and then press the *talk* key.

- * If the number is longer than 12 digits, the display will scroll to the left until the last number is shown in the display.

4. To see all calls stored in memory, press the ▲ key repeatedly until the LCD displays END.



To see the time and day a call was received:

1. While the name and number are displayed press ☎



2. To return to the name and number display press ☎

To see how many times a caller has phoned:

1. While the name and number are displayed, press **9/#**.



2. To return to the name and number display press **9/#**.

Calling the Displayed Number

To dial the number currently displayed, press the **talk** key.

To add a 1 for long distance dialing, press 1 and then press the **talk** key.

Deleting Caller ID messages

Only individual messages can be deleted on the XCI 660. To delete messages follow the steps below.

1. Press *caller id*.



2. Press ▲ or ▼ to scroll to the call you want to delete.



3. Press and hold *chan/delete* for at least three seconds. A double beep tone sounds to confirm the message has been deleted.



The next name and number is displayed.

4. Repeat steps 2 and 3 to delete any other calls from the caller id memory.
5. Press *caller id* when finished.

Programming Your Phone

Storing a Caller ID memory number in Dial Memory

- * *There are 20 dial memory locations in the XCI-660 Series cordless phone.*

You can store any number in your Caller ID memory in Dial memory so it can be used later with memory dialing. See Calling a Number Stored in Memory on page 41 for details on how to use the memory dial feature.

1. Remove the Handset from the Base Unit.
2. Press *caller id*.



3. Press ▲ or ▼ until the call you want to store is displayed.



4. Press *mem*.



5. Enter the memory location, for example, **05**. You hear a confirmation beep and the LCD displays:



Storing a Regular Number in Dial Memory

- * *There are 20 dial memory locations in the XCI-660 Series cordless phone.*

You can manually enter any number into dial memory so that it can be dialed later.

1. Remove the Handset from the Base Unit.
2. Press *flash/function*.



3. Press 1.



4. Enter the phone number you want to store. For example, **123-4567**.



5. Press *mem*.



6. Enter a name up to 12 characters long using the ▼ and ▲ keys to select characters and the ◀ or ▶ to move one character to left or right.

For example, to enter the name Bob Jones:

Press ▼ until B is displayed in the LCD.

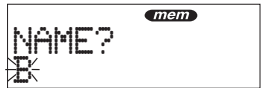

Press ▶ to move one character to the right.

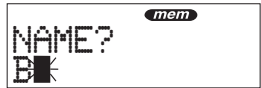

Press ▼ until o is displayed in the LCD.

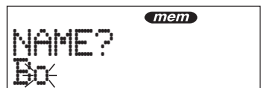

Press ▶ to move one character to the right.

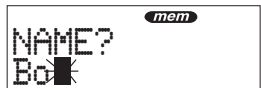

Press ▼ until b is displayed in the LCD.



Continue until the name Bob Jones is displayed in the LCD.



NAME?
Bob Jones

7. Press **mem**.



LOCATION?

8. Enter a memory location for the number. For example, press **05** to assign location 05 to the number. You hear a confirmation beep and the LCD displays:



STORING

Calling a Number Stored in Memory

Use this feature to dial a number previously stored in memory. See Storing a Caller ID memory number in Dial Memory on page 39 or Storing a Regular Number in Dial Memory on page 39 for details.

1. Remove the Handset from the Base Unit.
2. Press **mem**.



LOCATION?

3. Enter the memory location. For example, for memory location 05, press **05**.

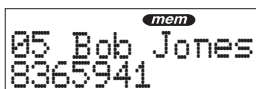

05 Bob Jones
8365941

* *If you want to dial a different number stored in dial memory, use the ▲ and ▼ keys to scroll through the numbers stored in memory.*

4. Press **talk** to dial the number.

Editing and Deleting Numbers in Dial Memory

Use this feature to edit or delete numbers stored in dial memory.

1. Remove the Handset from the Base Unit.
2. Press *flash/function*.



DIAL MEMORY?
MEM-1 EDIT-0

3. Press *0*.



LOCATION?

4. Enter the memory location to edit or delete. For example, to edit or delete location 05, press *05*.

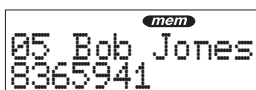

05 Bob Jones
8365941

— OR —

Use the ▲ and ▼ keys to scroll to the memory location.

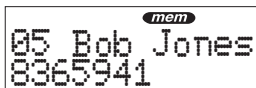

05 Bob Jones
8365941

To delete the entry in dial memory:

Press and hold *chan/delete* for two seconds. A confirmation tone sounds and the memory location is cleared.



05
No memory

To edit the number entry in dial memory, for example, to change 5941 to 1234:

Press *mem*.



Press *chan/delete* four times.



Enter **1234**.



To edit the name entry in dial memory, for example to change Bob Jones to Tom Jones:

Press *mem* again.

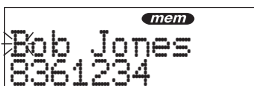

Press ▼ until T is displayed in the LCD.

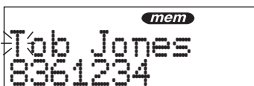

Press ► twice to move two characters to the right.

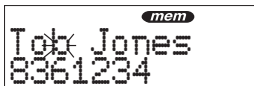

Press ▼ until m is displayed in the LCD.

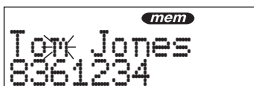

Press *mem*.



Troubleshooting

If your XCI-660 Series Cordless Telephone is not performing to your expectations, please try these simple steps. If you are still unable to resolve the problems, contact Uniden Customer Service at (800) 297-1023, 8:00 a.m. to 5:00 p.m. Central, Monday through Friday.

Problem	Suggestion
Charge light won't come on when Handset is placed in Base Unit.	<ul style="list-style-type: none">• Make sure AC Adapter is plugged into the Base Unit and wall outlet.• Make sure Handset is properly seated in Base Unit.• Make sure that the charging contacts on the Handset and Base Unit are clean.
Audio sounds weak and/or scratchy.	<ul style="list-style-type: none">• Make sure that the Base Unit antenna is fully extended and vertical.• Move the Handset and/or Base Unit to different locations and try again.• Press the <i>chan/delete</i> key to select another channel.
Can't make or receive calls.	<ul style="list-style-type: none">• Check both ends of the Base Unit telephone line cord.• Make sure the AC Adapter is plugged into the Base Unit and wall outlet.• Disconnect the AC Adapter for a few minutes, and then reconnect it.

Problem	Suggestion
Handset doesn't ring or receive a page.	<ul style="list-style-type: none">• Nickel-Cadmium battery pack may be weak. Charge the battery on the Base Unit for 15–20 hours.• Extend the Base Unit antenna vertically.• The Handset may be too far away from the Base Unit.• Place the Base Unit away from noise sources.• The Digital Security Code may be erased. Set the Digital Code.
Hear only continuous static from Handset and phone will not turn off.	<ul style="list-style-type: none">• The power has been interrupted during a call.• Restore power to the Base Unit. Make sure the phone is not plugged into an outlet controlled by a wall switch.• If a power failure has occurred and power will be out for some time, remove the battery from the Handset. This will prevent the battery from completely discharging.

Specifications

General – The XCI-660 Series complies with FCC Parts 15 and 68.

Frequency Control	PLL
Modulation	FM
Operating Temperature	-10°C to 50°C

Base Unit

Receive Frequency	48.76 to 49.99 MHz (25 Channels)
Transmit Frequency	43.72 to 46.97 MHz (25 Channels)
Power Requirements	120V AC 60 Hz (3V AC
Size (w/o antenna)	8.½"H X 3.½"W X 2.¼"D
Weight	Approximately 11.1 oz.

Handset

Receive Frequency	43.72 to 46.97 MHz (25 Channels)
Transmit Frequency	48.76 to 49.99 MHz (25 Channels)
Power Requirements	Rechargeable Ni-Cd Battery Pack
Size	7¾"H X 2"W X 2¼"D
Weight (w/battery)	Approximately 11.7 oz.
Battery	BT-185
Capacity	270mAh 3.6V
Talk Mode	8 hours
Standby Mode	14 days

Specifications, Features, and availability of Optional Accessories are all subject to change without prior notice.

XCI 660 Series



uniden
Operating Guide

OMXCI660-A

Caller ID Trim Style Extend.A.Phone®

PRECAUTIONS

Before you read anything else,
please observe the following:

WARNING!

Uniden America Corporation **DOES NOT** represent this unit to be waterproof. To reduce the risk of fire, electrical shock, or damage to the unit, **DO NOT** expose this unit to rain or moisture.

RECHARGEABLE NICKEL-CADMIUM BATTERY WARNING

- This equipment contains a Rechargeable Nickel-Cadmium Battery.
- Cadmium is a chemical known to the State of California to cause cancer.
- The Rechargeable Nickel-Cadmium Battery contained in this equipment may explode if disposed of in a fire.
- **Do not** short-circuit the battery.
- **Do not** charge the Rechargeable Nickel-Cadmium Battery used in this equipment in any charger other than the one designed to charge this battery as specified in this Guide . Using another charger may damage the battery or cause the battery to explode.

RECHARGEABLE NICKEL-CADMIUM BATTERIES MUST BE RECYCLED OR DISPOSED OF PROPERLY

- Residents of Minnesota should contact 1-800-225-PRBA for information concerning reclamation and disposal of Rechargeable Nickel-Cadmium Batteries.
- Residents outside of Minnesota should contact their local authorities for information concerning reclamation and disposal of Rechargeable Nickel-Cadmium Batteries.



The exclamation point within an equilateral triangle is intended to alert the user to the presence of important operating and maintenance (servicing) instructions in the literature accompanying the appliance.

One-Year Limited Warranty

Important: Evidence of original purchase is required for warranty service.

WARRANTOR: UNIDEN AMERICA CORPORATION
("Uniden")

ELEMENTS OF WARRANTY: Uniden warrants, for one year, to the original retail owner, this Uniden Product to be free from defects in materials and craftsmanship with only the limitations or exclusions set out below.

WARRANTY DURATION: This warranty to the original user shall terminate and be of no further effect 12 months after the date of original retail sale. The warranty is invalid if the Product is (A) damaged or not maintained as reasonable or necessary, (B) modified, altered, or used as part of any conversion kits, subassemblies, or any configurations not sold by Uniden, (C) improperly installed, (D) serviced or repaired by someone other than an authorized Uniden service center for a defect or malfunction covered by this warranty, (E) used in any conjunction with equipment or parts or as part of any system not manufactured by Uniden, or (F) installed or programmed by anyone other than as detailed by the Operating Guide for this product.

STATEMENT OF REMEDY: In the event that the product does not conform to this warranty at any time while this warranty is in effect, warrantor will repair the defect and return it to you without charge for parts, service, or any other cost (except shipping and handling) incurred by warrantor or its representatives in connection with the performance of this warranty. THE LIMITED WARRANTY SET FORTH ABOVE IS THE SOLE AND ENTIRE WARRANTY PERTAINING TO THE PRODUCT AND IS IN LIEU OF AND EXCLUDES ALL OTHER WARRANTIES OF ANY NATURE WHATSOEVER, WHETHER EXPRESS, IMPLIED OR ARISING BY OPERATION OF LAW, INCLUDING, BUT NOT LIMITED TO ANY IMPLIED WARRANTIES OF MERCHANTABILITY OR FITNESS FOR A PARTICULAR PURPOSE. THIS WARRANTY DOES NOT COVER OR PROVIDE FOR THE REIMBURSEMENT OR PAYMENT OF INCIDENTAL OR CONSEQUENTIAL DAMAGES. Some states do not allow this exclusion or limitation of incidental or consequential damages so the above limitation or exclusion may not apply to you.

LEGAL REMEDIES: This warranty gives you specific legal rights, and you may also have other rights which vary from state to state. This warranty is void outside the United States of America.

PROCEDURE FOR OBTAINING PERFORMANCE OF WARRANTY: If, after following the instructions in this Operating Guide you are certain that the Product is defective, pack the Product carefully (preferably in its original packaging). Include evidence of original purchase and a note describing the defect that has caused you to return it. The Product should be shipped freight prepaid, by traceable means, or delivered to warrantor at:

Uniden America Corporation
Parts and Service Division
4700 Amon Carter Blvd.
Fort Worth, TX 76155
(800) 297-1023, 8 a.m. to 5 p.m. Central,
Monday through Friday

Covered under one or more of the following U.S. patents:

4,511,761

4,595,795

4,797,916

4,523,058

uniden[®]

©1997 Uniden America Corporation.
All rights reserved.

Printed in the U.S.A.

Free Manuals Download Website

<http://myh66.com>

<http://usermanuals.us>

<http://www.somanuals.com>

<http://www.4manuals.cc>

<http://www.manual-lib.com>

<http://www.404manual.com>

<http://www.luxmanual.com>

<http://aubethermostatmanual.com>

Golf course search by state

<http://golfingnear.com>

Email search by domain

<http://emailbydomain.com>

Auto manuals search

<http://auto.somanuals.com>

TV manuals search

<http://tv.somanuals.com>