

**Uniden®**

**XS1415/1415+1**  
Owner's Manual

# OWNER'S MANUAL

# Contents

<b>Welcome</b> .....	2	Selecting the Ring Tone and Volume .....	26
<b>Terminology/Manual Conventions</b> .....	3	Adjusting the Earpiece Volume .....	26
<b>Product Overview</b> .....	4	Using Call Waiting .....	27
<b>Controls and Functions</b> .....	5	Selecting a Different Channel .....	27
<b>Installing the Phone</b> .....	7	Find Handset .....	27
Choosing the Best Location .....	7	Voice Mail Waiting Indicator .....	28
Installing the Rechargeable Battery Packs into the Handsets .....	8	<b>Caller ID and CIDCW (Caller ID on Call Waiting)</b> .....	29
Installing the Base Unit and Charging Cradle (XS1415+1 only) .....	9	Caller ID on Call Waiting (CIDCW) .....	30
Mounting the Base Unit on a Wall .....	11	Viewing the Caller ID Message List .....	30
<b>Register Handsets to the Main Base before Using!</b> .....	13	Deleting Information from the Caller ID List .....	31
When to Re-register Handsets .....	14	<b>Changing the Digital Security Code</b> .....	32
<b>Basic Setup</b> .....	15	<b>Maintenance</b> .....	33
Activating AutoTalk .....	15	<b>Troubleshooting</b> .....	36
Activating Caller ID on Call Waiting (Handset No.1 only) .....	16	Liquid Damage .....	39
Setting Name Tag (POP ID) .....	16	<b>Index</b> .....	40
Setting Insert 0 .....	17	<b>Warranty</b> .....	42
<b>Using the Speed Dial Memory</b> .....	18		
Storing a Name and Number in Memory .....	19		
Storing Caller ID in Speed Dial Memory .....	22		
<b>Using Your Phone</b> .....	23		
Making and Receiving Calls .....	23		
Making a Call from Speed Dial Memory .....	23		
Making a Call from the Caller ID List .....	24		
Easy Dial (New Zealand only) .....	25		
Transferring a Call .....	25		
Redialing the Last Dialed Number .....	26		

## Welcome

Congratulations on your purchase of the Uniden single handset (XS1415) or dual handset (XS1415+1) cordless telephone. This phone is designed and engineered to exacting standards for reliability, long life, and outstanding performance.

**Note:** Illustrations in this manual may differ from the actual unit for explanation purposes. The color of your cordless phone may vary.

## Terminology

<b>Base</b>	The main part of the phone that connects to your phone line and lets you make and receive calls.
<b>Charger</b>	A cradle that charges the handset battery. It connects to power but does not connect to a phone line.
<b>CID</b>	Caller ID is available from your telephone provider. With this service, you can see the name and number of incoming callers.
<b>CIDCW</b>	Caller ID on Call Waiting is available from your telephone provider. With this service, you can see incoming caller information while on another call.
<b>Handset</b>	A cordless handset that can be placed anywhere in your home or office where AC power is available.
<b>Standby</b>	The handset may be sitting on the cradle or out of the cradle, but is NOT in use. <b>[talk/flash]</b> has not been pressed and there is no dial tone.
<b>Talk</b>	When a dial tone has been enabled allowing the user to dial and carry on a conversation with an outside party.

## Manual Conventions

This manual uses several different type styles to help you distinguish between different parts of the phone:

- **lower case bold** text with "[ ]" indicates a key or button on the phone
- ALL CAPITALS indicates text on the display, such as menu options, prompts, and confirmation messages
- **lower case bold** text indicates a status light on the phone base

# Product Overview

## Main Phone Features

- Dual Handset System (Extra Handset & Charger Included - XS1415+1 only)
- Call Transfer from Handset to Handset (XS1415+1 only)
- Caller ID\*
- Caller ID on Call Waiting\*
- 3-Line Backlit LCD
- 30 Caller ID Memory
- 10 Number Memory Dialing
- Last Number Redial
  
- Voice Mail Waiting Indicator
- Tone Dialing
- Find Handset Key
- Earpiece/Ringer Volume Controls
- Mute or Turn Ringer Off
- Hearing Aid Compatible
- 20 Channel Auto Scan
- Desk or Wall Mountable

\* Requires subscription to service provided by your network supplier. There is usually a fee for this service. Caller ID on Call Waiting service is currently only available in Australia.

## Controls and Functions XS1415+1 Handset

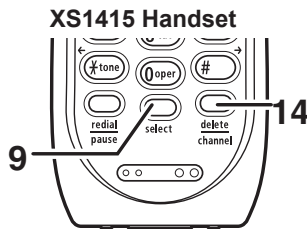
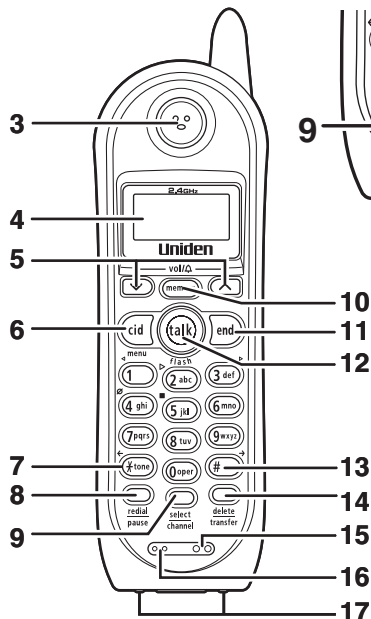

1. Handset antenna
2. Handset battery compartment
3. Handset earpiece
4. LCD display
5. [vol/Δ/∇] (volume & ringer up/down) key
6. [cid/menu] key
7. [\*/tone/←] (left cursor) key
8. [redial/pause] key
9. [select/channel] key (XS1415+1)  
[select] key (XS1415)
10. [memory] key
11. [end] key
12. [talk/flash] key
13. [#/?] (right cursor) key
14. [delete/transfer] key (XS1415+1)  
[delete/channel] key (XS1415)
15. Handset ringer speaker
16. Handset microphone
17. Handset charging contacts

## Main Base Unit

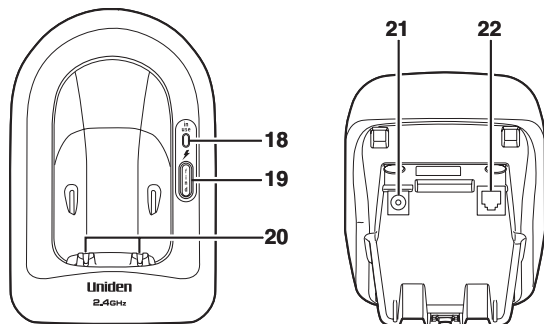

- 18. **in use** /  (in use/charge) LED / Voice mail waiting indicator (flashing)
- 19. **[find]** key
- 20. Base charging contacts
- 21. Base **DC IN 9V** jack
- 22. **TEL LINE** jack

## Extra Charging Cradle (XS1415+1 only)

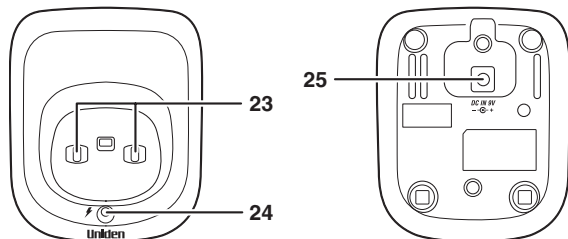









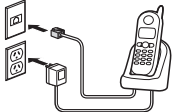

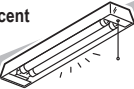
- 23. Charging contacts
- 24.  (charge) LED
- 25. Charging cradle **DC IN 9V** jack

# Installing the Phone

## Choosing the Best Location

When choosing a location for your new phone, here are some important guidelines you should consider:

PLACE YOUR BASE	TRY TO AVOID		
 <p>Near an AC outlet and a telephone wall jack.</p>	<ul style="list-style-type: none"><li>• Microwave ovens</li><li>• Refrigerators</li></ul> 	<ul style="list-style-type: none"><li>• Fluorescent lighting</li></ul> 	<ul style="list-style-type: none"><li>• Other cordless telephones</li></ul> 
 <p>In a centrally-located open area.</p>	<ul style="list-style-type: none"><li>• TVs</li><li>• Other electronics</li></ul> 	<ul style="list-style-type: none"><li>• Personal computers</li><li>• Wireless LAN equipment</li></ul> 	<ul style="list-style-type: none"><li>• Areas with a lot of background noise</li></ul> 
	<ul style="list-style-type: none"><li>• Direct sunlight</li><li>• Extreme temperatures</li></ul> 	<ul style="list-style-type: none"><li>• Dust</li><li>• Excessive moisture</li></ul> 	<ul style="list-style-type: none"><li>• Shock</li><li>• Vibration</li></ul> 

Note: For maximum range:

- Keep both the base and handset antennas free of obstruction.
- When the handset is not in use, place the handset in an upright position.
- Metal and reinforced concrete may affect cordless telephone performance.



## Installing the Rechargeable Battery Packs into the Handsets

Each handset is powered by a rechargeable battery pack. Once installed, the battery charges automatically when the handset is placed in the base or charging cradle (XS1415+1 only).

To install the rechargeable battery pack:

- 1) Press down on the handset battery case cover (use the finger indentation for a better grip) and slide the cover downward to remove.
- 2) Plug the battery pack connector (red & black wires) into the small jack inside the battery compartment. (The connector notches fit into the grooves of the jack only one-way.) Match the wire colors to the polarity label in the battery compartment, connect the battery, and listen for a click to insure connection.
- 3) Make sure you have a good connection by slightly pulling on the battery wires. If the connection is secure, the battery jack will remain in place.
- 4) Place the battery case cover back in the handset by sliding it upwards until it clicks into place.

**Note: Use only the Uniden (BT-905s) rechargeable battery pack supplied with your phone.**

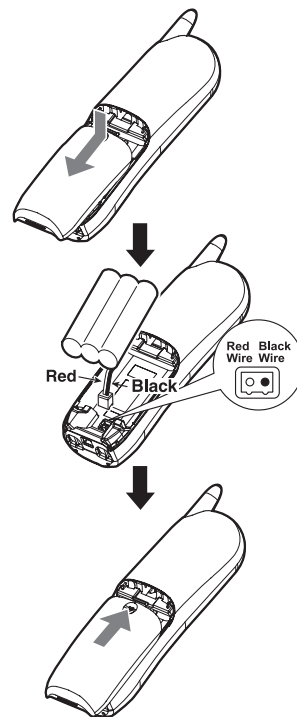

## Installing the Base Unit and Charging Cradle (XS1415+1 only)

- 1) Connect each AC adapter to the **DC IN 9V** jack and to each standard 240V AC wall outlet.

### Note:

- Use only the supplied **PS-S0921YL3 AC adapter** for the base unit and **AAD-600S(M)** for the charging cradle (XS1415+1 only). Do not use any other AC adapter.
  - Do not place the power cord where it creates a trip hazard or where it could become chafed and create a fire or electrical hazard.
- 2) Charge the handsets by placing one handset in the base unit and the other in the charging cradle (XS1415+1 only) with the keypad facing forward.

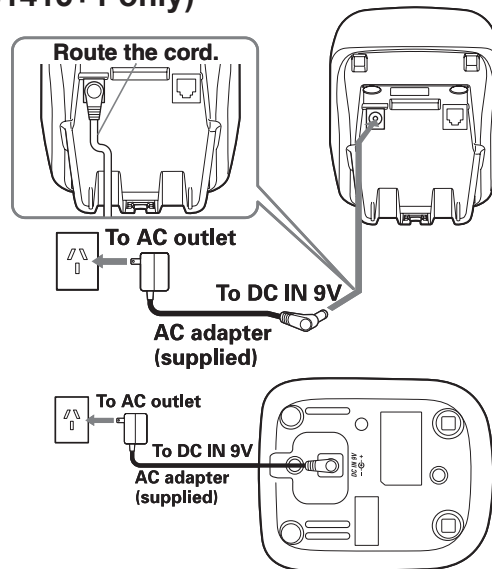

- 3) Make sure that the **in use** LED and LED (XS1415+1 only) illuminate. If the LED does not illuminate, check to see that the AC adapter is plugged in and that the handset makes good contact with the cradle's charging contacts.

**Note:**

- **Connect the AC adapter to a continuous power supply**
- **Place each cradle close to the AC outlet to avoid long extension cords.**
- **Charge your handsets at least 15 - 20 hours before plugging into the phone line.**

- 4) Once the handset battery packs are fully charged, connect the telephone cord to the **TEL LINE** jack and a telephone outlet. If your telephone outlet isn't modular, contact your telephone company for assistance.

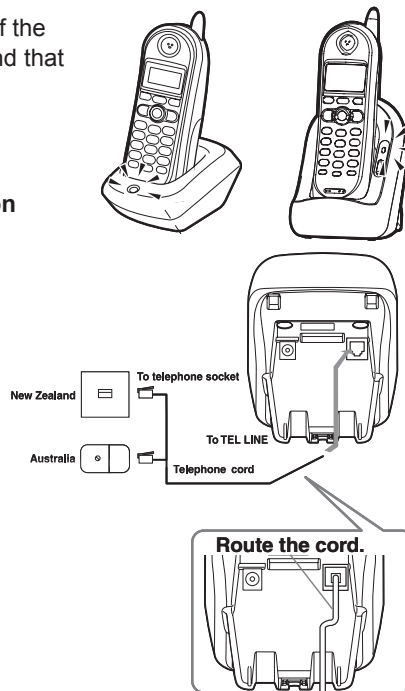

## Mounting the Base Unit on a Wall

### Standard wall plate mounting

This phone can be mounted on any standard wall plate.

- 1) Plug the AC adapter to the **DC IN 9V** jack.
- 2) Plug the AC adapter into a standard **240V** AC wall outlet.
- 3) Plug the telephone cord into the **TEL LINE** jack.
- 4) Route the telephone cord through the groove as shown.
- 5) Plug the telephone cord into the telephone outlet.
- 6) Align the mounting slots on the base with the mounting posts on the wall. Then push in and down until the phone is firmly seated.

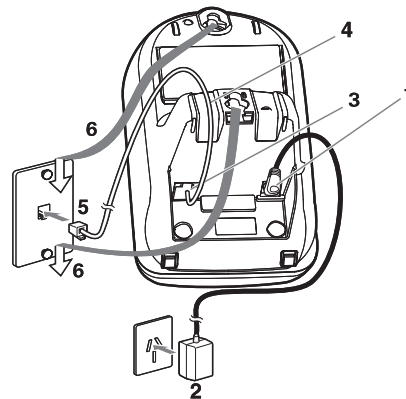

## Direct wall mounting

If you don't have a standard wall plate, you can mount your phone directly to the wall. Before doing this, consider the following:

- Avoid electrical cables, pipes, or other items behind the mounting location that could cause a hazard when inserting screws into the wall.
  - Try to mount your phone within 1.5m of a working phone jack to avoid excessive cord lengths.
  - Make sure the wall material is capable of supporting the weight of the base and handset.
  - Use #10 screws (minimum length of 35mm) with anchoring devices suitable for the wall material where the base unit will be placed.
- 1) Insert two mounting screws into the wall (with their appropriate anchoring device), 100mm apart. Allow about 3mm between the wall and screw heads for mounting the phone.
  - 2) Refer to steps 1 through 6 on page 11 to mount the telephone.

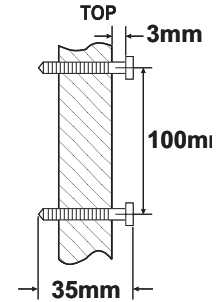

## Register Handsets to the Main Base before Using! (XS1415+1 only)

Both handsets will need to be registered to the main base unit before use. Whichever handset you choose to charge in the base unit will automatically register to the base unit. The handset charging in the extra charging cradle MUST also be registered to the base unit before use.

To register the extra handset:

- 1) Be sure both handsets are fully charged.
- 2) Pick up the handset from the charging cradle, and place it in the base unit. The **in use** LED light on the base unit will begin to flash, indicating that the registration is taking place.
- 3) Wait for at least 5 seconds, then pick up the handset from the base unit.
- 4) Press **[talk/flash]** on one handset. If TALK appears on the display, the handset is registered, press **[end]**. Then try with another handset. If each handset displays TALK, the handset has been registered to the base. Otherwise, return to step 1 and try again.
- 5) Once both handsets are registered, it doesn't matter which handset is placed in the base unit or the charging cradle.

### Note:

- When you charge the handsets, Caller ID summary screen and the name of the handset appears. Following display is the example of handset No.1 (Handset No.1).
- The charging cradle can be used to charge any handset.

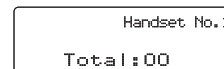

## When to Re-register Handsets (XS1415+1 only)

In some cases, it may be necessary to re-register your handsets. To re-register your handsets, please follow registration steps outlined on page 13.

Re-registration is required in the following scenarios:

- 1) You'll need to re-register both handsets (follow steps on page 13) each time the digital security code is changed. (Refer to page 32 for details regarding the Digital Security Code.)
- 2) When there is a power failure for more than one hour: If power failure occurs (e.g. due to electrical storm or if the unit is unplugged during a move), both handsets will need to be re-registered. To re-register, follow the same registration process on page 13.
- 3) If any handset's battery becomes very low, the handset must be recharged for 15 - 20 hours and re-registered to the main base unit.
- 4) In any circumstance in which you experience difficulty connecting to the main base to place or receive calls, the handset should be re-registered.

**Note: Make sure to return the handsets to the cradles after each phone call.**

## Basic Setup

There are four basic options that you will need to set up: AutoTalk, CIDCW (Caller ID on Call Waiting), Name Tag and Insert 0.

CIDCW option can only be set by using Handset 1. If you try to set by using Handset 2, you will not see these options listed on the LCD screen. (Handset 1 shows in the display while the Handset No.1 phone is charging XS1415+1 only).

▶Auto Talk	:Off
CIDCW	:On
Name Tag	:On

AutoTalk, Name Tag and Insert 0 options can be set by using either Handset 1 or Handset 2 (XS1415+1 only).

## Activating AutoTalk

AutoTalk will allow you to answer the phone simply by removing the handset from the cradle. You do not have to press a key to answer the incoming call.

To activate:

- 1) When the phone is in standby, press and hold **[cid/menu]**. The following screen appears.
- 2) Press **[select/channel]** (XS1415+1) or **[select]** (XS1415) to turn AutoTalk on.
- 3) Press **[end]** or return the handset to the charging cradle to complete the setting. The handset returns to standby.

▶Auto Talk	:Off
CIDCW	:On
Name Tag	:On



## Activating Caller ID on Call Waiting (Handset No.1 only)

Caller ID allows you to see the name and number of the calling party before you answer the phone. Caller ID on Call Waiting (CIDCW) lets you see the name and number of a call that comes in when you are on the line. You must subscribe to Caller ID service through your local telephone provider to use this feature.

- 1) When the phone is in standby, press and hold **[cid/menu]**. The following screen appears.
- 2) Press **[vol/Δ/∇]** to move the pointer to select CIDCW.
- 3) Press **[select/channel]** (XS1415+1) or **[select]** (XS1415) to toggle and turn Caller ID on Call Waiting ON or OFF.
- 4) Press **[end]** and return the handset to the base unit to complete the setting. The handset returns to standby.

▶Auto Talk	:Off
CIDCW	:On
Name Tag	:On

Auto Talk	:Off
▶CIDCW	:On
Name Tag	:On

**Note: To enable the setting change of CIDCW, you need to return the handset to the base unit when you complete the setting.**

## Setting Name Tag (POP ID)

The Name Tag feature works with the Caller Display number from Caller ID. You must subscribe to Caller ID service through your local telephone provider to use this feature. There is usually a fee for this service. When the phone rings the caller display number, when received will be compared to numbers stored in the dial memory. If there is a match any name stored with the dial memory number will be displayed (see page 23).

- 1) When the phone is in standby mode, press and hold the **[cid/menu]** key. the following screen appears.
- 2) Press the **[vol/Δ/∇]** key twice to select NAME TAG.
- 3) Press the **[select/channel]** (XS1415+1) or **[select]** (XS1415) to toggle and turn Name Tag ON or OFF.
- 4) Press **[end]** key or return the handset to charging cradle to complete the setting. The handset returns to standby mode.

▶Auto Talk	:Off
CIDCW	:On
Name Tag	:On

Auto Talk	:Off
CIDCW	:On
▶Name Tag	:On

## Setting Insert 0

This feature adds '0' or '00' to the number, when you receive Caller ID messages. The default setting for New Zealand is On. The default setting for Australia is Off.

- 1) When the phone is in standby mode, press and hold the **[cid/menu]**.

The following screen appears.

- 2) Press the **[vol/Δ/∇]** key three times to select INSERT 0.
- 3) Press the **[select]** key (XS1415) or the **[select/channel]** key (XS1415+1) to toggle and turn Insert 0 ON or OFF.
- 4) Press **[end]** key or return the handset to charging cradle to complete the setting. The handset returns to standby mode.

```
▶Auto Talk :Off
CIDCW      :On
Name Tas   :On
```

```
CIDCW      :On
Name Tas   :On
▶Insert 0  :On
```

## Using the Speed Dial Memory

Your cordless phone allows you to store up to 10 names and numbers in each handset. You can dial these numbers with just a few key presses. The speed dial memory is not limited to phone numbers. You can store any number (up to 20 digits) that you need to enter once your call connects. This is referred to as Chain Dialing. An example is a frequently refilled prescription number. Store your pharmacy phone number in one speed dial and your most frequently refilled prescription number as another speed dial. To use, once you ring your pharmacy's automated prescription line, simply press **[memory]** and the speed dial number where you stored your prescription number and press **[select/channel]** (XS1415+1) or **[select]** (XS1415).

**Note: When editing the speed dial memory, you must press a key within 30 seconds or the phone will return to standby. If you return the handset to the cradle, the phone will return to standby also.**

## Storing a Name and Number in Memory

- 1) With the phone in standby, press **[memory]**.
- 2) Enter **[0] - [9]** or use **[vol/Δ/∧]** and **[vol/Δ/∨]** to select the speed dial location where you would like to store this entry, and then press **[select/channel]** (XS1415+1) or **[select]** (XS1415) twice.

```
Select Memory
01▶
02 JOHN DOE
```

- 3) STORE NAME appears and a cursor flashes indicating that the phone is ready for the name to be entered.

```
Store Name
█
```

**Note: If the selected speed dial number is already assigned, the Edit screen appears. You can select EDIT MEMORY to edit this entry, select DELETE MEMORY to erase this entry, or select GO BACK to choose another speed dial number.**

```
▶Edit Memory01
Delete Memory01
Go Back
```

**Note: For New Zealand: Telecom access numbers are pre-programmed into speed dial locations as follows.**

- Divert On: SPD1
- Divert Off: SPD2
- Block CID: SPD3
- Messages: SPD4
- Directory: SPD6

- 4) Enter a name according to the instructions below, then press **[select/channel]** (XS1415+1) or **[select]** (XS1415).  
 If no name is required, go to step 5.
- The name can be up to 13 characters.
  - Use **[#/tone/←]** and **[#/→]** to move the cursor to the desired location.
  - Press **[delete/transfer]** (XS1415+1) or **[delete/channel]** (XS1415). to delete characters as needed or press and hold to delete all characters.

Refer to the letters on the number keys to select the desired characters.

With each press of a numeric key, the displayed character appears in the following order: upper case letters first, lower case letters next and finally the number corresponding to the key.

**Note: If the next character uses the same number key, you must press [#/→] to move the cursor over. Otherwise the next time you press the number key, it changes the character that was previously set.**

For example, to enter **Movies**.

- 1) Press **[6]** once. Then press **[#/→]** to move the cursor to the right.
- 2) Press **[6]** six times.
- 3) Press **[8]** six times.
- 4) Press **[4]** six times.
- 5) Press **[3]** five times.
- 6) Press **[7]** eight times.

	Number of times key is pressed								
keys	1	2	3	4	5	6	7	8	9
<b>1</b>	1								
<b>2abc</b>	A	B	C	a	b	c	2		
<b>3def</b>	D	E	F	d	e	f	3		
<b>4ghi</b>	G	H	I	g	h	i	4		
<b>5jkl</b>	J	K	L	j	k	l	5		
<b>6mno</b>	M	N	O	m	n	o	6		
<b>7pqrs</b>	P	Q	R	S	P	q	r	s	7
<b>8tuv</b>	T	U	V	t	u	v	8		
<b>9wxyz</b>	W	X	Y	Z	w	x	y	z	9
<b>0oper</b>	*	#	-	&	(	)	(blank)	0	

### If you make a mistake while entering a name

Use **[\*/tone/←]** or **[#/→]** to move the cursor to the incorrect character.

Press **[delete/transfer]** (XS1415+1) or **[delete/channel]** (XS1415) to erase the wrong character. Then enter the correct character. To delete all characters, press and hold **[delete/transfer]** (XS1415+1) or **[delete/channel]** (XS1415).

- 5) STORE NUMBER is displayed. The cursor flashes indicating that the phone is ready for the number to be entered.

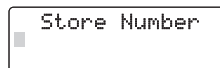

Store Number

- 6) Use the keypad to enter the phone number; each number can be up to 20 digits. If you need the phone to pause during the dialing sequence, press **[redial/pause]** to insert a two-second delay between the numbers. You can enter multiple pauses to increase the delay. Each pause counts as a digit. The display shows a P for every pause.

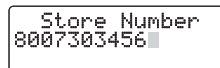

Store Number  
8007303456

- 7) Press **[memory]**. You will hear a confirmation tone, and the following screen appears. Memory storage is complete.

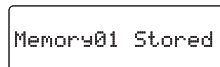

Memory01 Stored

- 8) After about 2 seconds, the following screen displays all the speed dial memory entries.



01▶Movies  
02 JOHN DOE  
03 MOM AND DAD

- 9) Press **[end]** to exit memory setup mode. The phone returns to standby.

**Note: When storing numbers into memory, if the handset is idle (i.e., no key is pressed) for more than 30 seconds, it will beep rapidly, and the phone will return to standby.**

## Storing Caller ID in Speed Dial Memory

Caller ID names and numbers shown in the Caller ID list can be stored in speed dial memory.

To store a caller id name/number to memory:

- 1) With the phone in standby, press [**cid/menu**]. Select the phone number to be stored from the Caller ID list by pressing [**vol/Δ/∧**] or [**vol/Δ/∨**].
- 2) Press [**memory**].
- 3) Enter a number ( [**0**] – [**9**] ) or press [**vol/Δ/∧**] or [**vol/Δ/∨**] to select the memory location to be stored.
- 4) Press [**select/channel**] (**XS1415+1**) or [**select**] (**XS1415**). You hear a confirmation tone, and the number is stored in memory. The display returns to the Caller ID list.

### Note:

- If a number has already been stored in the selected memory number location, a confirmation screen is displayed. To overwrite, press [**vol/Δ/∧**] to YES and press [**select/channel**] (**XS1415+1**) or [**select**] (**XS1415**). The display returns to the Caller ID list.
- You cannot store a Caller ID message if no phone number appears in the message.

```
17/05 12:30PM  
Jane Smith  
2145551234
```

```
Select Memory  
01  
02 JOHN DOE
```

```
17/05 12:30PM  
Jane Smith  
2145551234
```

```
Replace Memory?  
Yes  
▶ No
```

## Using Your Phone

### Making and Receiving Calls

	Handset on the cradle	Handset off the cradle
<b>Making a call</b>	1) Pick up the handset from the cradle. 2) Press <b>[talk/flash]</b> . 3) Listen for the dial tone. 4) Dial the number. OR 1) Pick up the handset from the cradle. 2) Dial the number. Then press <b>[talk/flash]</b> .	1) Press <b>[talk/flash]</b> . 2) Listen for the dial tone. 3) Dial the number. OR Dial the number. Then press <b>[talk/flash]</b> .
<b>Receiving a call</b>	1) Pick up the handset from the cradle. (If AutoTalk is on, the phone will answer the call when you pick it up.) 2) Press <b>[talk/flash]</b> .	Press <b>[talk/flash]</b> (or <b>[/tone/←]</b> , <b>[/#→]</b> or any number key if AutoTalk is on).
<b>Hanging up</b>	Press <b>[end]</b> or return the handset to the cradle.	

**Note:** To turn on the AutoTalk feature, see "Activating AutoTalk" on page 15.

### Making a Call from Speed Dial Memory

To make a call from speed dial memory:

- 1) With the phone in standby, press **[memory]**. The handset displays your programmed speed dial number.

```

Select Memory
01▶Movies
02 JOHN DOE
  
```



- 2) Enter the number ( [0] – [9] ), or press [vol/Δ/∧] or [vol/Δ/∨] to select the speed dial number you would like to dial.
- 3) Press [talk/flash]. CONNECTING changes to TALK, and the volume setting and the number selected appear on the display. Then the displayed number is dialed.

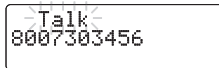

**Note: You can also press [talk/flash] before you access the speed dial memory.**

**When you come to the phone number you want to dial, press [select/channel] (XS1415+1) or [select] (XS1415).**

### To cancel speed dialing

Press [end] to return to standby. If accessing the list during an active call, you can press [memory] to exit the list immediately. If no key is pressed for 30 seconds, the handset will exit the speed dial list automatically.

**Note: Pressing [end] to exit the speed dial list during a call will disconnect the call immediately.**

### Making a Call from the Caller ID List

You can place a call directly from the Caller ID list.

- 1) Press [cid/menu] in standby. Use [vol/Δ/∧] or [vol/Δ/∨] to select the phone number that you want to dial.
- 2) Press [talk/flash]. The displayed phone number dials automatically.

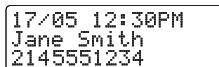

**Note:**

- You can also press [talk/flash] before you access the Caller ID list. When you come to the phone number you want to dial, press [select/channel] (XS1415+1) or [select] (XS1415).
- You cannot make a call from the Caller ID list if your cordless telephone is connected to a private branch exchange (PBX).

## Easy Dial (New Zealand only)

Numbers stored in the speed dial memory can be accessed directly from standby mode as follows.

- 1) Press and hold a key from memory location for 1.5 seconds.  
The details of the memory location will appear on the display.
- 2) Press **[talk/flash]** on the handset. The displayed number is dialed.

01:Divert ON  
161

## Transferring a Call (XS1415+1 only)

Your cordless phone allows you to transfer outside calls from one handset to another. Only one handset at a time can talk with an outside caller. While one handset is in use, the other cannot go off hook to listen to conversations or make an outgoing call.

### To transfer a call

- 1) During a call, press **[delete/transfer]**. The call will automatically be placed on hold and the transfer tone sounds.
- 2) When the other handset receives the call, the transfer tone stops.  
To cancel the transfer and return to the caller, press **[delete/transfer]** or **[talk/flash]** on the handset.

Hold  
Transfer Call

### To receive a transfer call

Pick up the handset from the cradle (when AutoTalk is set to on), or pick up the handset and press **[talk/flash]** to answer the transferred call. Additionally, you can also answer the transferred call by pressing any number key, **[\*/tone/←]** or **[#/→]** (when AutoTalk is set to on).

Transfer Call

**Note: If you transfer a call and it is not picked up after 5 minutes, the call will be disconnected.**

## Redialing the Last Dialed Number

- 1) Pick up the handset from the cradle.
  - 2) Press **[talk/flash]**.
  - 3) Listen for the dial tone.
  - 4) Press **[redial/pause]**.
- OR
- 1) Pick up the handset from the cradle.
  - 2) Press **[redial/pause]**.
  - 3) Press **[talk/flash]**.

## Selecting the Ring Tone and Volume

Your phone has five different ringer tone/volume combinations you can choose from.

To select the ringer:

- 1) With the phone in standby, press **[vol/A/^]** or **[vol/A/v]**.
- 2) The phone will sound the different ring tones at different volumes. To turn the ringer off, select RINGER OFF.
- 3) When the phone sounds the ring tone and volume you wish to use, press **[end]**.

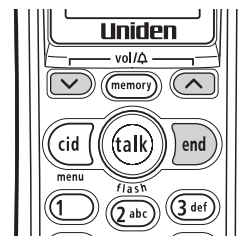

## Temporarily Mute Ringer

If the handset is off the base while an incoming call is ringing, simply press **[end]** to mute the incoming ring. The ringer will sound with the next incoming call.

**Note: You can only mute the handset ringer if the handset is off the base when the phone starts ringing.**

## Adjusting the Earpiece Volume

To change the earpiece volume, press **[vol/A/^]** or **[vol/A/v]** during a call.

## Using Call Waiting

If you have Call Waiting service, you can receive calls while on the line. If a call comes in while you are on the phone, you will hear a call waiting tone. If you have CIDCW activated, you will see the name and number of the incoming caller.

Australia: Press **[talk/flash]** key and then 2 key to switch between callers.

New Zealand: Press **[talk/flash]** key to switch between callers.

**Note:** You must subscribe to Call Waiting through your local telephone company.

## Selecting a Different Channel

Your phone incorporates **UltraClear Plus** true compander circuitry which virtually eliminates background noise. This innovative technology, together with 20 different channels, provides you with the best possible reception during all your conversations. If you happen to encounter interference while using your phone, you can manually change the phone's channel for clear operation. To change the channel during a call, press **[select/channel]** (XS1415+1) or **[delete/channel]** (XS1415). SCANNING appears on the display, indicating the phone is changing to another channel.

## Find Handset

To locate a lost handset, press **[find]** on the base. The handsets will beep for 60 seconds. The beeping will stop when any handset key is pressed or when **[find]** is pressed. The handset will also stop beeping automatically when an incoming call is received.

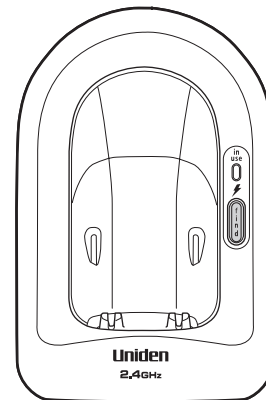
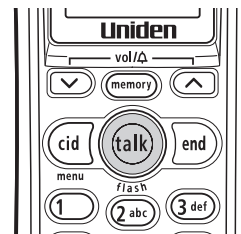

## Voice Mail Waiting Indicator

If you subscribe to voice mail service through your local telephone company, you can use your cordless telephone to access your voice mailbox. **The voice mail company will provide you with the access number.**

The **in use** LED on the base of your phone flashes whenever you have messages waiting in your voice mailbox.

### To access your voice mailbox

Just dial the access number supplied by your voice mail provider to enter your mailbox.

You can program your voice mail access number to a speed dial number.

If the voice mail waiting indicator remains on after you have retrieved your messages, press and hold **[find]** for 5 seconds. This will reset the indicator.

## Caller ID and CIDCW (Caller ID on Call Waiting)

You must subscribe to Caller ID services through your local telephone provider to use these features.

When the telephone rings, the Caller ID feature allows you to view the caller's name, phone number, date and time of call. The incoming call information is stored in the Caller ID record. If the Caller ID service includes the caller's name, the caller's name appears on the display (up to 15 letters).

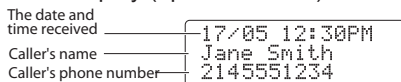

You may receive any one of the following messages:

When invalid data is received

When a private name is received

When a private number is received

When an unknown name is received

When an unknown number is received

When an overseas call(0000) is received (New Zealand only)

When a call is coming from a payphone (Australia only)

INCOMPLETE DATA

PRIVATE NAME

PRIVATE NUMBER

UNKNOWN NAME

UNKNOWN NUMBER

OVERSEAS CALL

PAYPHONE

### Note:

- Data errors appear as "■".
- If you answer a call before the Caller ID message is received (for example, before the second ring), the Caller ID message will not appear.
- When the call is received via a telephone company that does not offer Caller ID service, the caller's phone number and name do not appear. (This includes some international calls.)
- When the call is received via a private branch exchange (PBX), the caller's phone number and name may not appear.

## Caller ID on Call Waiting (CIDCW)

If you subscribe to CIDCW offered by your telephone company, you will hear a Call Waiting tone while you are on a call, and the Caller ID data will be displayed at the handset. To accept the waiting call, see "Using Call Waiting" on page 27.

**Note: While you are on a call, the received Caller ID data is stored on the handset that is on a call only.**

## Viewing the Caller ID Message List

The Caller ID list stores information for up to 30 incoming calls - even unanswered calls. You can also view the Caller ID list during a call.

- 1) Press **[cid/menu]**. The summary screen displays the number of new messages and total messages.
- 2) Use **[vol/Δ/∇]** to scroll through the messages from the latest to the earliest, or use **[vol/Δ/∇]** to scroll through the messages from the earliest to the latest.
- 3) Press **[cid/menu]** to return to the call, or press **[end]** to return to standby.

Caller ID New :01 Total:02
----------------------------------

17/05 12:30PM Jane Smith 2145551234
---

**Note:**

- In Caller ID operation, if no key is pressed for more than 30 seconds, an error tone sounds and the handset returns to standby.
- Each message can be up to 15 characters for the name and 15 digits for the phone number.
- The number of calls from the same Caller ID appears next to the received time. Once you view the new message, the number will be cleared and disappear.
- During a call, don't press **[end]**, or the call will be disconnected.

## Deleting Information from the Caller ID List

If the phone receives more Caller ID messages than it can store, the oldest one in the list is automatically deleted. Caller ID data can also be deleted manually.

### Deleting a Caller ID message

- 1) Press **[cid/menu]** in standby. Find the message to be deleted from the Caller ID list by pressing **[vol/Δ/∧]** or **[vol/Δ/∨]**.
- 2) Press **[delete/transfer]** (XS1415+1) or **[delete/channel]** (XS1415).
- 3) Press **[vol/Δ/∧]** or **[vol/Δ/∨]** to select YES, and then press **[select/channel]** (XS1415+1) or **[select]** (XS1415).

```
17/05 12:30PM
Jane Smith
2145551234
```

```
Delete Message?
▶ Yes
No
```

### Deleting all Caller ID names/numbers

- 1) With the phone in standby, press **[cid/menu]**.
- 2) Press **[delete/transfer]** (XS1415+1) or **[delete/channel]** (XS1415).
- 3) Press **[vol/Δ/∧]** or **[vol/Δ/∨]** to select YES, and then press **[select/channel]** (XS1415+1) or **[select]** (XS1415).

```
Caller ID
New :01
Total:02
```

```
Delete Message?
▶ Yes
No
```

You hear a confirmation tone and all stored Caller ID messages are deleted.

#### Note:

- While using the **DELETE ALL?** or **DELETE MESSAGE?** screen, if no key is pressed for more than 30 seconds, an error tone sounds, and the handset returns to standby.
- If you get an incoming call or page, the deleting operation is canceled and you can answer the call or page.



## Changing the Digital Security Code

To protect you against misbilled calls which might result from your phone being activated by other equipment, the cordless phone provides **Random Code** digital security which automatically selects one of over 262,000 digital security codes for each handset and the base. If the handset battery pack is completely discharged or the battery pack is removed, the digital security code will be lost. If this happens, a new security code is set automatically the next time the battery pack is charged. In the rare situation that you suspect another cordless telephone is using the same security code, you can change the code.

### For XS1415;

- 1) Pick up the handset from the cradle. Press and hold **[find]** on the base.
- 2) While holding **[find]**, place the handset in the base, and leave the handset in the base for more than 3 seconds. A new random security code is set.

### For XS1415+1;

- 1) Pick up the handset from the cradle. Press and hold **[find]** on the base.
- 2) While holding **[find]**, place the handset in the base, and leave the handset in the base for more than 3 seconds.
- 3) Pick up the handset from the base. Then place the second handset in the base and wait for more than 3 seconds. No need to hold **[find]** this time.
- 4) Press **[talk/flash]** on one handset. Once you make sure TALK appears on the display, press **[end]**. Then, try with the other handset. If each handset displays TALK, a new security codes is set. Otherwise, return to step 1 and try again.

## Maintenance Specifications

<b>Operating temperature</b>	-10°C to +50°C (+14°F to +122°F)		
<b>AC Adapter</b>		<b>For the base</b>	<b>For the charger</b>
	<b>Part number</b>	PS-S0921YL3	AAD-600S(M)
	<b>Input Voltage</b>	240V AC 50Hz	240V AC 50Hz
	<b>Output Voltage</b>	9V DC 210mA	9V DC 210mA
<b>Battery</b>	<b>Part number</b>	BT905s	
	<b>Capacity</b>	500mAh, 3.6V	

**Note:** To avoid damage to the phone use only Uniden PS-S0921YL3, AAD-600S(M) and BT905s with your phone.

Specifications, features, and availability of optional accessories are all subject to change without prior notice.

### Power Failure

During the period that the power is off, you will not be able to make or receive calls with the telephone.

## Talk and Standby Times

With average use, your handset battery provides approximately 6 hours of talk time and approximately 12 days (XS1415) or 6 days (XS1415+1) of standby time. When your handset is not being used and is left off of the charging cradle the battery will gradually discharge. You can achieve optimum battery life and performance by returning the handset to the charging cradle after each use. If the handset is left off of the charging cradle, the actual talk time duration will be reduced respective to the amount of time the handset is off of the charging cradle.

## Low battery alert

When the battery pack is very low and needs to be charged, the phone is programmed to eliminate functions in order to save power. If the phone is not in use, LOW BATTERY appears on the LCD and none of the keys will operate. During a call, LOW BATTERY flashes and the handset beeps. Complete your conversation as quickly as possible and return the handset to the cradle for charging.



Low Battery

**Note: Information stored in the phone's memory will be retained for 30 minutes after the battery pack is removed. This includes all setup information, last number dialed, speed dial memory, and the CID list.**

Even when the battery pack is not being used, it will gradually discharge over a long period of time. For optimum performance, be sure to return the handset to the cradle after a telephone call.

## Battery replacement and handling

Recharge your phone on a regular basis by returning the handset to either cradle after each phone call. When the operating time becomes short even after a battery is recharged, please replace the battery. With normal usage, your battery should last about one year. To order replacement batteries, please contact Uniden's Parts Department. The contact information is listed on the back cover page.

### Warning:

To avoid the risk of personal injury or property damage from fire or electrical shock, only use the Uniden battery model and Uniden adapter model specifically designated for this product.

### Caution

- Use only the specified Uniden battery pack (BT905s).
- Do not remove the battery from the handset to charge it.
- Never throw the battery into a fire, disassemble it, or heat it.
- Do not remove or damage the battery casing.

## Cleaning the battery charging contacts

To maintain a good charge, clean the charging contacts on the handset once a month. Dampen a cloth with plain water. Gently rub the damp cloth over the charging contacts until all visible dirt is removed. Dry the contacts thoroughly before returning the handset to the cradle.

### Caution

Do not use paint thinner, alcohol, or other chemical products. Doing so may discolor the surface of the telephone and damage the finish.



## Troubleshooting

### Traveling Out-of-Range

During a call, as you begin to move your handset too far from your base unit, noise increases. If you pass the range limits of the base, your call will terminate within one minute.

### Common Issues

If your phone is not performing to your expectations, please try these simple steps first. If these steps do not solve your problem, please call our Customer Hotline. See back cover page for contact information.

Symptom	Suggestion
The <b>in use</b> LED or LED won't illuminate when the handset is placed in the cradle.	<ul style="list-style-type: none"><li>• Make sure the AC adapter is plugged into the cradle and wall outlet.</li><li>• Make sure the handset is properly seated in the cradle.</li><li>• Make sure the charging contacts on the handsets are clean.</li></ul>
The audio sounds weak and/or scratchy.	<ul style="list-style-type: none"><li>• Move the handset and/or base away from metal objects or appliances and try again.</li><li>• Press <b>[select/channel]</b> (XS1415+1) or <b>[delete/channel]</b> (XS1415) during a call to help eliminate background noise.</li><li>• Make sure that the handset is not too far from the base.</li></ul>

Symptom	Suggestion
Can't make or receive calls.	<ul style="list-style-type: none"> <li>• Re-register both handsets (see page 13).</li> <li>• Check both ends of telephone cord.</li> <li>• Make sure the AC adapter is plugged into the base and wall outlet.</li> <li>• Disconnect the AC adapter for a few minutes, then reconnect it.</li> <li>• Change the digital security code (see page 32).</li> <li>• Make sure that the handset is not too far from the base.</li> </ul>
The handset doesn't ring or receive a page.	<ul style="list-style-type: none"> <li>• Re-register both handsets (see page 13). (XS1415+1 ONLY)</li> <li>• The battery pack may be weak. Charge the battery for 15-20 hours.</li> <li>• The handset may be too far away from the base unit.</li> <li>• Place the base unit away from appliances or metal objects.</li> <li>• Change the digital security code (see page 32).</li> <li>• Check the battery pack to ensure there is a secure connection.</li> <li>• Make sure ringer volume isn't set to "off."</li> </ul>
Severe noise interference.	<ul style="list-style-type: none"> <li>• Keep both handsets away from microwave ovens, computers, remote control toys, wireless microphones, alarm systems, intercoms, room monitors, fluorescent lights, and electrical appliances.</li> <li>• Move the base to another location or turn off the source of interference.</li> </ul>

Symptom	Suggestion
The Caller ID does not display.	<ul style="list-style-type: none"> <li>• The call was answered before the second ring.</li> <li>• The call was placed through a switchboard.</li> <li>• Charge the handset.</li> <li>• Your Caller ID service may not be active; contact your local telephone service provider.</li> </ul>
A handset is not working.	<ul style="list-style-type: none"> <li>• Make sure the battery pack is connected to the handset and fully charged.</li> <li>• Re-register the non-functional handset.</li> </ul>
Unavailable message is displayed on the LCD screen of the handset (XS1415+1 only).	<ul style="list-style-type: none"> <li>• Make sure the other handset is not already in use. Both handsets cannot be in talk at the same time.</li> <li>• Place the handset in the base for at least 5 seconds to re-register to the base.</li> <li>• Make sure the handset is not too far from the base when trying to use.</li> </ul>
The handset doesn't communicate with the base or the other handset (XS1415+1 only).	<ul style="list-style-type: none"> <li>• Re-register both handsets (see page 13).</li> </ul>
No 3- way conversation (XS1415+1 only).	<ul style="list-style-type: none"> <li>• Only one handset at a time can talk with an outside caller. To allow the other handset to talk to the caller, transfer the call.</li> </ul>
Voice Message Indication does not work.	<ul style="list-style-type: none"> <li>• Contact your local telephone company to make sure that your telephone receives FSK message signaling.</li> <li>• Reset the indicator by pressing and holding <b>[find]</b> for 5 seconds.</li> </ul>

## Liquid Damage

Moisture and liquid can damage your cordless phone.

- If the handset or base is exposed to moisture or liquid, but only the exterior plastic housing is affected, wipe off the liquid, and use as normal.
- If moisture or liquid has entered the plastic housing (i.e. liquid can be heard in the phone or liquid has entered the handset battery compartment or vent openings on the base), follow the steps below:

Handset	Base
<ol style="list-style-type: none"><li>1) Remove the battery cover and leave it off for ventilation.</li><li>2) Disconnect the battery pack. Leave the battery cover off and the battery pack disconnected for at least 3 days.</li><li>3) Once the handset is completely dry, reconnect the battery pack and the battery cover.</li><li>4) Recharge the handset's battery pack for 15 to 20 hours before using.</li></ol>	<ol style="list-style-type: none"><li>1) Disconnect the AC adapter from the base, cutting off electrical power.</li><li>2) Disconnect the telephone cord from the base.</li><li>3) Let dry for at least 3 days.</li></ol>

### IMPORTANT:

You must unplug the telephone line while recharging the battery pack to avoid charge interruption.

### CAUTION:

DO NOT use a microwave oven to speed up the drying process. This will cause permanent damage to the handset, base and the microwave oven. After following these steps, if your cordless telephone does not work, please visit our website for further information ([www.uniden.com.au](http://www.uniden.com.au) or [www.uniden.co.nz](http://www.uniden.co.nz)). See back cover page for contact information.



# Index

<b>A</b>		<b>D</b>		<b>S</b>	
AC adapter information.....	33	Digital security code .....	32	Speed dial memory	
				Making calls from speed dial	
				memory.....	23
<b>B</b>		<b>E, F, G, H</b>		Storing names and numbers in	
Basic setup.....	15	Earpiece volume.....	26	speed dial memory .....	19
Battery pack		Find handset.....	27		
Information.....	33				
Installing .....	8	<b>I, J, K, L</b>		<b>T, U</b>	
Preparing and charging .....	8, 9	Installing the phone .....	7	Talk and standby times .....	34
Replacement and handling.....	35	Liquid damage .....	39	Transferring a Call .....	25
				Traveling out-of-range .....	36
<b>C</b>				Troubleshooting.....	36
Call waiting .....	27	<b>M, N, O, P, Q</b>			
Caller ID service .....	29	Maintenance .....	33	<b>V, W, X, Y, Z</b>	
Caller ID on call waiting .....	30	Making a call.....	23	Voice mail waiting indicator .....	28
Deleting .....	31			Wall mounting.....	11
Making a call.....	24	<b>R</b>		Warranty .....	42
Viewing .....	30	Receiving a call .....	23		
Channel .....	27	Redial .....	26		
Charging the battery pack .....	9	Register handsets.....	13		
Cleaning contacts .....	35	Ringer tone and volume .....	26		
Connect the cradle .....	9				
Controls and functions.....	5, 6				



# One Year Limited Warranty

**Important:** Evidence of original purchase is required for warranty service.

## **UNIDEN XS1415 and XS1415+1 Cordless Phone**

**Warrantor:** Uniden Australia Pty Limited A.B.N. 58 001 865 498  
Uniden New Zealand Limited  
**Warranty only available in original country of purchase.**

### **ELEMENT OF WARRANTY:**

Uniden warrants to the original retail owner for the duration of this warranty, its XS1415 and XS1415+1 Cordless Phone (herein after referred to as the Product), to be free from defects in materials and craftsmanship with only the limitations or exclusions set out below.

### **WARRANTY DURATION:**

This warranty to the original retail owner only, shall terminate and be of no further effect ONE (1) year after the date of original retail sale. This warranty will be deemed invalid if the Product is;

- (A) Damaged or not maintained as reasonable and necessary,
- (B) Modified, altered or used as part of any conversion kits, subassemblies, or any configurations not sold by Uniden,
- (C) Improperly installed,
- (D) Repaired by someone other than an authorized Uniden Repair Agent for a defect or malfunction covered by this warranty,
- (E) Used in conjunction with any equipment or parts or as part of a system not manufactured by Uniden, or
- (F) Where the Serial Number label of the product has been removed or damaged beyond recognition.

### **PARTS COVERED:**

This warranty covers for one (1) year, the Product and included accessories.

### **STATEMENT OF REMEDY:**

In the event that the Product does not conform to this warranty at any time while this warranty is in effect, the warrantor at its discretion, will repair the defect or replace the Product and return it to you without charge for parts or service. This warranty does not provide for reimbursement or payment of incidental or consequential damages.

This EXPRESS WARRANTY is in addition to and does not in any way affect your rights under the TRADE PRACTICES ACT 1974 (Cth) (Australia) or the CONSUMER GUARANTEES ACT (New Zealand).

### **PROCEDURE FOR OBTAINING PERFORMANCE OR WARRANTY:**

In the event that the Product does not conform to this warranty, the Product should be shipped or delivered, freight pre-paid, with evidence of original purchase (e.g. a copy of the sales docket), to the warrantor at:

#### **UNIDEN AUSTRALIA PTY LIMITED**

**SERVICE DIVISION**  
345 Princes Highway,  
Rockdale NSW 2216  
Fx (02) 9599 3278  
www.uniden.com.au

#### **UNIDEN NEW ZEALAND LIMITED**

**SERVICE DIVISION**  
150 Harris Road,  
East Tamaki, Auckland  
Fx (09) 274 4253  
www.uniden.co.nz

# Uniden®

© 2008 Uniden Australia Pty Limited/Uniden New Zealand Limited  
Printed in China UPZZ01131ZZ(0)

## Free Manuals Download Website

<http://myh66.com>

<http://usermanuals.us>

<http://www.somanuals.com>

<http://www.4manuals.cc>

<http://www.manual-lib.com>

<http://www.404manual.com>

<http://www.luxmanual.com>

<http://aubethermostatmanual.com>

Golf course search by state

<http://golfingnear.com>

Email search by domain

<http://emailbydomain.com>

Auto manuals search

<http://auto.somanuals.com>

TV manuals search

<http://tv.somanuals.com>