

**QUICK
EASY STEPS**
FOR SETTING UP YOUR PHONE!
SEE YOUR QUICK REFERENCE GUIDE SECTION

Uniden®



900MHz

WITH CALLER ID/CALL WAITING
AND ONE TOUCH VOICEMAIL ACCESS

EXT 176 SERIES
OWNER'S MANUAL

Download from [Www.Somanuals.com](http://www.Somanuals.com). All Manuals Search And Download.

www.uniden.com

Contents

| | | | |
|--|----|--|----|
| Welcome/Features | 2 | Making Calls with Memory Dialing | 25 |
| Quick Reference Guide | 3 | Chain Dialing | 26 |
| Controls and Functions | 4 | Editing a Stored Name and/or Phone Number | 27 |
| Getting Started | | Erasing a Stored Name and Phone Number | 29 |
| Read this First | 6 | Voice Mail | |
| Checking the Package Contents | 7 | Using One Touch Voice Mail Access | 30 |
| Setting up the Phone | 8 | Caller ID Features | |
| Mounting the Base Unit on a Wall | 12 | Caller ID | 32 |
| Terminology | 13 | When the Telephone Rings | 32 |
| Setting Menu Options | 14 | Viewing the Caller ID Message List | 33 |
| Basics | | Deleting Information from the Caller ID List | 34 |
| Making and Receiving Calls | 17 | Using the Caller ID List | 36 |
| Adjusting the Handset Ringer and Earpiece Volume | 18 | Additional Information | |
| Redial | 19 | Changing the Digital Security Code | 38 |
| Tone Dialing Switch-over | 19 | Installing the Beltclip | 38 |
| Traveling Out-of-Range | 19 | Headset Installation | 38 |
| Selecting a Different Channel | 20 | Note on Power Sources | 39 |
| Page | 20 | Maintenance | 39 |
| Flash and Call Waiting | 20 | Troubleshooting | 40 |
| Memory Dialing | | General Information | 43 |
| Storing Phone Numbers and Names | 21 | Precautions & Warranty | 44 |
| Steps for Entering Names and Special Characters | 23 | I.C. Notice | 46 |
| | | Index | 47 |

Welcome

Congratulations on your purchase of the Uniden EXT176 series cordless telephone. This phone is designed and engineered to exacting standards for reliability, long life, and outstanding performance.

Note: Some illustrations in this manual may differ from the actual unit for explanation purposes. The color of your cordless phone may vary.



As an ENERGY STAR® Partner, Uniden has determined that this product or product models meets the ENERGY STAR® guidelines for energy efficiency. ENERGY STAR® is a U.S. registered mark.

Features

- 900 MHz Extended Range Technology
- 3 Line Backlit Display
- Caller ID and Call Waiting Caller ID
- Voice Mail
- 10 Number Memory Dialing
- 32 Digit Redial
- Flash and Pause
- English or French Display Option
- Tone/Pulse Dialing
- Page/Find Handset
- 7 Hour Talk Time/14 Day Standby Time
- Handset Earpiece and Ringer Volume Control
- Hearing Aid Compatible
- 20 Channel Autocan

The EXT176 series features include **AutoTalk™** and **AutoStandby™**. AutoTalk allows you to answer a call by just removing the handset from the base so you don't have to waste time pushing buttons. AutoStandby allows you to hang up by simply returning the handset to the base.

The **UltraClear Plus™** true compander circuitry virtually eliminates background noise. This innovative technology, together with 20 different channels, provides you with the best possible reception during all your conversations.

To protect you against misbilled calls which might result from your phone being activated by other equipment, the EXT176 series has **Random Code™** digital security which automatically selects one of approx. 262,000 digital security codes for the handset and base. Also, the **AutoSecure™** feature electronically locks your phone when the handset is in the base.

Be sure to visit our web site: www.uniden.com

Uniden® is a registered trademark of Uniden America Corporation. AutoTalk, AutoStandby, UltraClear Plus, Random Code, and AutoSecure are trademarks of Uniden America Corporation.

Step 1 Charging the Battery

TO INSTALL THE HANDSET BATTERY

- 1 Remove the cover.

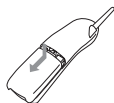

- 2 Connect the battery pack connector with the correct polarity.

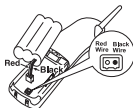

- 3 Replace the cover.



TO PLUG INTO AC POWER

- 1 Plug AC adapter cord into the base unit and then into a 120V AC outlet. (Use only the supplied AD-310 AC adapter.)

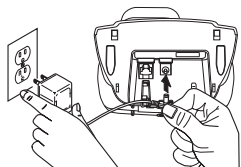

- 2 Place the handset in the base.

Note: You must charge the battery continuously for 15 - 20 hours before using the phone.

Step 2 Connecting

CONNECT TO A PHONE LINE

When the handset battery pack is fully charged, after 15-20 hours of charging, plug the telephone cord into the base unit and then into a telephone wall jack.

Your phone is set for tone dialing. If your local network requires pulse dialing, please see "Choosing the dialing mode" on page 15.

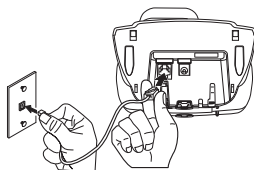

Step 3 Setting Up the Caller ID/Language

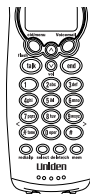

Note: Three Caller ID options are available: AutoTalk, Caller ID on Call Waiting (CIDCW), and Area Code.

TO CHANGE CALLER ID OPTIONS

- 1 Press and hold **cid/menu**.
- 2 Press **^** or **v** to move the pointer to an option.
- 3 Press **select** to change the option setting.
- 4 Press **end** and return the handset to the base.

TO CHOOSE THE LANGUAGE

- 1 Press and hold **cid/menu**.
- 2 Press **^** or **v** to move the pointer to **Language**.
- 3 Press **select** to select **Eng** (English) or **Fr.** (French).
- 4 Press **end** and return the handset to the base.

Controls and Functions

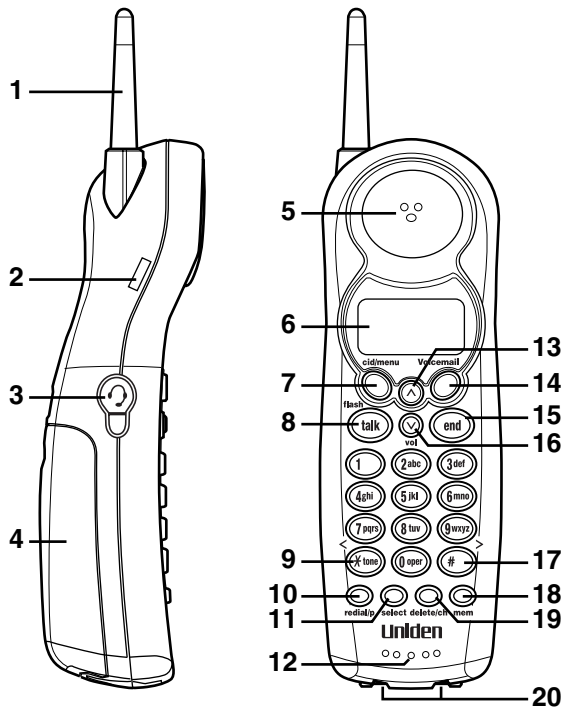

1. Handset antenna
2. Beltclip holes
3. Optional headset jack
4. Handset battery compartment
5. Handset earpiece
6. LCD display
7. Cid (Caller ID)/menu key
8. Talk/flash key
9. * /tone/ < (left cursor) key
10. Redial/p (pause) key
11. Select key
12. Handset microphone and ringer speaker
13. ^ (volume up) key
14. Voicemail key
15. End key
16. v (volume down) key
17. # /> (right cursor) key
18. Mem (memory) key
19. Delete/ch (channel) key
20. Handset charging contacts

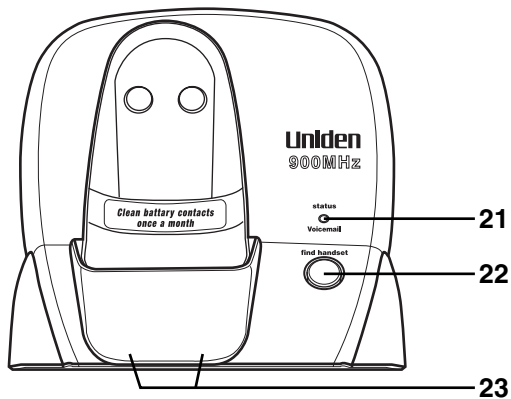

- 21. Status/Voicemail LED
- 22. Find handset key
- 23. Base charging contacts
- 24. Telephone line jack
- 25. DC IN 9V jack

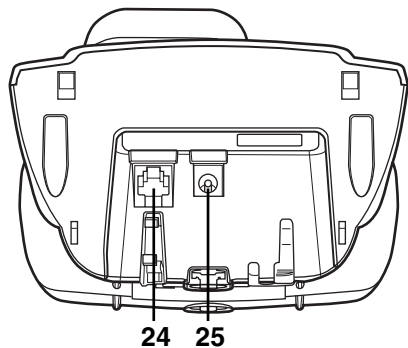

Read this First

This cordless telephone must be set up before use. Follow these steps:

Step 1 (page 7)

Unpack the telephone and accessories.

Step 2 (page 8)

Next, choose the best location to set up the base unit.



Step 3 (page 9 to 11)

Then, insert the battery pack into the handset. Connect the base unit. You must charge the battery pack for **15-20 hours before plugging into the telephone line and using the phone.**

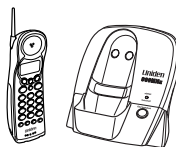

About the digital security code

This cordless telephone uses a digital security code to prevent unauthorized access to your base unit. This security code prevents other cordless handset from making calls through your base unit.

A random security code will be assigned automatically between your base unit and handset when you charge the battery pack for the first time.

If you want to change the security code, see page 38.

Checking the Package Contents

Make sure you have received the following items in the package. If any of these items are missing or damaged, contact the Uniden Parts Department.

- **Base unit**
- **Handset**
- **AC adapter (AD-310)**
- **Rechargeable battery (BT-905)**
- **Telephone cord**
- **Beltclip**
- **This Owner's Manual**
- **Other Printed Material**

Uniden Parts Department at (800) 554-3988
Hours: M-F 7:00 a.m. to 5:00 p.m. CST.
We can also be reached on the web at www.uniden.com

Setting up the Phone

Do the following steps:

- A. Choose the best location
- B. Install the battery pack
- C. Connect the base unit

A. Choose the best location

Before choosing a location for your new phone, read the INSTALLATION CONSIDERATIONS included in the PRECAUTIONS AND IMPORTANT SAFETY INSTRUCTIONS brochure. Here are some important guidelines you should consider:

Avoid heat sources, such as radiators, air ducts, and sunlight

Avoid television sets and other electronic equipment

Choose a central location

Avoid noise sources such as a window by a street with heavy traffic

Avoid microwave ovens

Avoid excessive moisture, extremely low temperatures, dust, mechanical vibration, or shock

Avoid personal computers

Avoid other cordless telephones

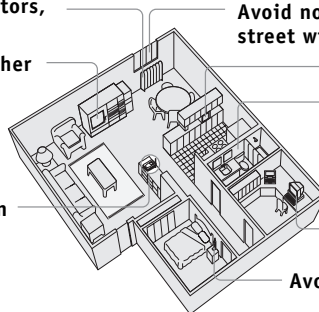

- The location should be close to both a phone jack and a continuous power outlet which is not switchable.
- Keep the base and handset away from sources of electrical noise such as motors, microwave ovens, and fluorescent lighting.
- The base can be placed on a desk, tabletop, or mounted on a standard wall plate.

B. Install the battery pack

Charge the battery pack for at least 15-20 hours before plugging the phone line into your phone.

- 1) Press in on the battery cover release and slide the cover down until it comes off.
- 2) Connect the battery pack connector observing correct polarity (black and red wires) to the jack inside the battery compartment.

Do not exert any force on this connection. It could cause damage to the battery or to the handset. The plastic connectors will fit together in only one way. Once you are certain that you have made a good connection, then insert the battery pack into the battery compartment. Do not pinch the wires.

- 3) Securely close the battery compartment cover by sliding it up until it snaps into place.
- 4) Place the handset in the base with the keypad facing forward.

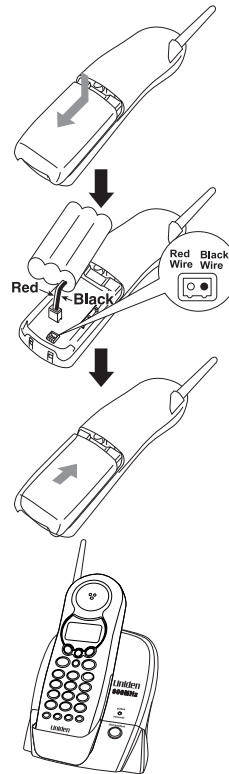

Use only the Uniden battery (BT-905) supplied with your phone. Replacement batteries are also available through the Uniden Parts Department. (See page 7.)



Even when the battery pack is not being used, it will gradually discharge over a long period of time. For optimum performance, be sure to return the handset to the base unit after a telephone call.

Battery use time (per charge)

From fully charged (15-20 hours charge time)

- Seven hours continuous use
- Fourteen days when the handset is in the standby mode

Low Battery Alert

When the battery pack is very low and needs to be charged, the phone is programmed to eliminate functions in order to save power. If the phone is not in use, "Low Battery" appears on the LCD and none of the keys will operate.

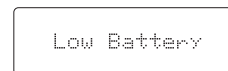

If the phone is in use, "Low Battery" flashes and the handset beeps. Complete your conversation as quickly as possible and return the handset to the base unit for charging.

Cleaning the Battery Charging Contacts

To maintain a good charge, it is important to clean the battery contacts on the handset and base unit with a dry cloth or a pencil eraser about once a month. Do not use any liquids or solvents.

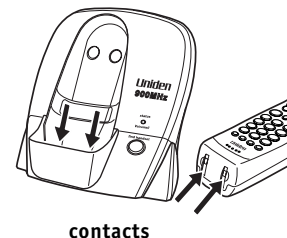

C. Connect the base unit

- 1) Connect the AC adapter to the **DC IN 9V** jack and to a standard 120V AC wall outlet.
- 2) Set the base on a desk or tabletop, and place the handset in the base unit.

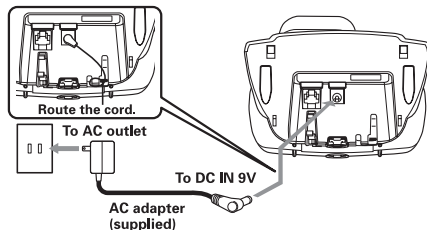

- 3) Make sure that the **status/Voicemail** LED illuminates. If the LED does not illuminate, check to see that the AC adapter is plugged in and that the handset makes good contact with the base charging contacts.



- Use only the supplied AD-310 AC adapter. Do not use any other AC adapter.
- Connect the AC adapter to a continuous power supply.
- Place the base unit close to the AC outlet so that you can unplug the AC adapter easily.

- After installing the battery pack in the handset, charge your handset at least **15-20 hours before plugging into the phone line**. Once the handset battery pack is fully charged, connect the telephone line cord to the base and telephone wall outlet.

- 4) Connect the telephone line cord to the **TEL LINE** jack and to a telephone outlet once the handset is fully charged.



If your telephone outlet isn't modular, contact your telephone company for assistance.



Place the handset in the base with the keypad facing forward for charging.



Place the power cord so that it does not create a trip hazard or where it could become chafed and create a fire or electrical hazard.



DO NOT use an AC outlet controlled by a wall switch.

Mounting the Base Unit on a Wall

Standard wall plate mounting

This phone can be mounted on any standard wall plate.

- 1) Plug the AC adapter into the **DC IN 9V** jack.
- 2) Wrap the AC adapter cord inside the molded wiring channel as shown.
- 3) Plug the AC adapter into a standard 120V AC wall outlet.
- 4) Plug the telephone line cord into the **TEL LINE** jack. Wrap the cord inside the molded wiring channel as shown.
- 5) Plug the telephone line cord into the telephone outlet.
- 6) Align the mounting slots on the base with the mounting posts on the wall. Then push in and down until the phone is firmly seated.

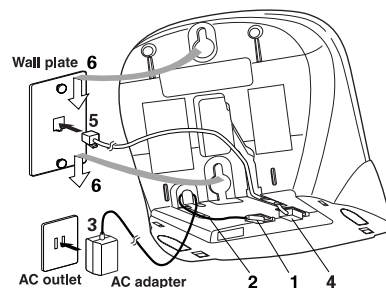

Direct wall mounting

If you don't have a standard wall plate, you can mount your phone directly to the wall. Before doing this, consider the following:

- Avoid electrical cables, pipes, or other items behind the mounting location that could cause a hazard when inserting screws into the wall.
- Try to mount your phone within 5 feet of a working phone jack to avoid excessive lengths.
- Make sure the wall material is capable of supporting the weight of the base and handset.
- Use #10 screws (minimum length of 1-3/8 inches) with anchoring devices suitable for the wall material where the base unit will be placed.

1) Insert two mounting screws into the wall, (with their appropriate anchoring device), 3-15/16 inches apart. Allow about 1/8 of an inch between the wall and screw heads for mounting the phone.

2) Refer to steps 1 through 6 on pages 12 to mount the telephone.

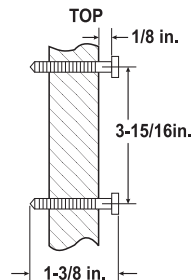

Terminology

Throughout this manual, terms such as Standby and Talk Mode are used. Below is the terminology explanation.

- **Standby Mode** - The handset is not in use, off the base, and *talk/flash* has not been pressed. A dial tone is not present.
- **Talk Mode** - The handset is off the base and *talk/flash* has been pressed enabling a dial tone.

Setting Menu Options

There are five setup options available. They are Caller ID options [AutoTalk, CIDCW (Caller ID on Call Waiting), Area Code], Dial Mode and Language.

AutoTalk allows you to answer the phone without pressing the **talk/flash** button. If the phone rings when AutoTalk is on, simply remove the handset from the base and the phone automatically answers the call. If the phone rings when AutoTalk is off, you must press **talk/flash** to answer the call.

Caller ID options

To change your AutoTalk and CIDCW:

1) Press and hold **cid/menu**. The following screen appears.

```
1▶ Auto Talk: Off
2 CIDCW       : On
3 Area Code:
```

2) Use **^** and **v** or a number key (1 and 2) to move the pointer to the selection that you would like to change.

Press **select** to toggle between "On" and "Off" for AutoTalk and CIDCW.

3) Press **end** and return the handset to the base unit. The handset returns to the standby mode.

To enter your Area Code

If you enter a 3-digit area code number in the Area Code option, your local area code does not appear in Caller ID messages. Do not program this option, if your calling area requires 10-digit dialing.

When reviewing Caller ID messages, you will see only the local seven digit number. For calls received from outside your local area code, you will see a full 10-digit number.

1) When the phone is in the standby mode, press and hold **cid/menu**. The following screen appears.

```
1 Auto Talk:Off
2 CIDCW      :On
3 Area Code:
```

2) Press **3** or press **∨** twice to select "Area Code".

```
1 Auto Talk:Off
2 CIDCW      :On
3 Area Code:
```

3) Press **select**.

```
1 Auto Talk:Off
2 CIDCW      :On
3 Area Code:█
```

4) Use the number keys (**0** to **9**), **#/ >** , ***/tone/ <** or **delete/ch** to enter the 3-digit area code.

5) Press **select**. A confirmation tone sounds and the displayed area code is entered.

6) Press **end** or return the handset to the base unit. The handset returns to the standby mode.

When the area code has already been stored in memory, the stored area code will be displayed. To change it, use the **delete/ch** and number keys to enter the new area code. Then press **select**. A confirmation tone sounds.

To complete the setting, press **end** or return the handset to the base unit.

```
1 Auto Talk:Off
2 CIDCW      :On
3 Area Code:817
```

note

note

Choosing the dialing mode

Most phone systems use tone dialing which sends DTMF tones through the phone lines. However some phone systems still use pulse dialing such as in rural areas. The default setting is tone dialing. Depending on your dialing system, set the mode as follows:

Make sure your battery pack is fully charged before choosing the dial mode.

1) When the phone is in the standby mode, press and hold **cid/menu**. The following screen appears.

```
1▶Auto Talk:Off
2 CIDCW      :On
3 Area Code:
```

2) Press **4** or press **∨** three times to select "Dial".

```
2 CIDCW      :On
3 Area Code:
4▶Dial       :Tone
```

3) Press **select** to toggle between "Tone" and "Pulse" for each setting.

4) Press **end** or return the handset to the base unit. The handset returns to the standby mode.

- If you are not sure of your dialing system, set for tone dialing. Make a trial call. If the call connects, leave the setting as is, otherwise set for pulse dialing.
- If your phone system requires pulse dialing and you need to send the DTMF tones for certain situations during a call, you may "switch-over" to tone dialing. (Refer to "Tone Dialing Switch-over" on page 19.)

Setting the Language

1) When the phone is in the standby mode, press and hold **cid/menu**. The following screen appears.

```
1▶Auto Talk:Off
2 CIDCW      :On
3 Area Code:
```

2) Press **5** or press **∨** four times to select "Language".

```
3 Area Code:
4 Dial       :Tone
5▶Language  :Eng
```

3) Press **select** to toggle between "Eng" and "Fr.." for each setting.

4) Press **end** or return the handset to the base unit. The handset returns to the standby mode.

Making and Receiving Calls



Refer to page 14 "Setting Menu Options" to turn on the AutoTalk feature if desired.

| | Handset On Base | Handset Off Base |
|------------------|--|---|
| To answer a call | Pick up the handset (AutoTalk: On) or pick up the handset and press talk/flash (AutoTalk: Off). | Press talk/flash , any number, */tone/ < or #/ > (AutoTalk: On). |
| To make a call | 1) Pick up the handset. 2) Press talk/flash . 3) Listen for the dial tone. 4) Dial the number. OR | 1) Press talk/flash . 2) Listen for the dial tone. 3) Dial the number. OR |
| | 1) Pick up the handset. 2) Dial the number, then press talk/flash . | Dial the number, then press talk/flash . |
| To hang up | Press end , or return the handset to the base (AutoStandby). | |
| To redial | 1) Pick up the handset. 2) Press talk/flash . 3) Listen for the dial tone. 4) Press redial/p . OR | 1) Press talk/flash . 2) Listen for the dial tone. 3) Press redial/p . OR |
| | 1) Pick up the handset. 2) Press redial/P , then press talk/flash . | Press redial/P , then press talk/flash . |





Adjusting the Handset Ringer and Earpiece Volume

Handset ringer tone and volume

Press \wedge or \vee in standby mode to select one of five ringer tones and volume combinations.

Earpiece volume

Pressing \wedge or \vee during a call will change the earpiece volume of the handset. This setting will remain in effect after the telephone call has ended.

Volume Maximum  Volume High  Volume Medium  Volume Low 



When you press \wedge in Maximum mode or \vee in Low mode, an error tone sounds.

Ringer Mute

You can temporarily mute the ringer tone. When receiving an incoming call, press **end** to stop the ringing. The handset will ring beginning with the next incoming call.

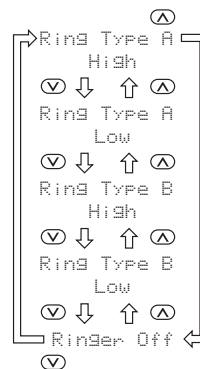

Redial

The **redial/p** key redials the last number dialed. The redialed number can be up to 32 digits long.

Tone Dialing Switch-over

Some telephone companies use equipment that requires pulse dialing (sometimes referred to as rotary dialing). If you need to enter tone dialing digits, you can switch-over to tone dialing during the call. For example, entering your bank account number after you have called your bank.

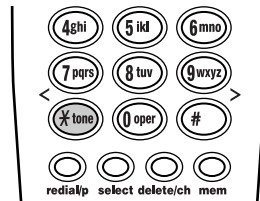

Initially make your call with the pulse dialing mode. Once your call connects, press ***/tone/ <**. Enter the desired number. These digits will be sent as tone dialing. Once the call ends, the tone mode is canceled and pulse dialing mode resumes.

Traveling Out-of-Range

During a call, as you begin to move your handset too far from your base unit, noise increases. If you pass the range limits of the base unit, your call will terminate within 5 minutes.



- The tone feature only applies when the dial mode is set to pulse.
- This special number can be stored in a memory location. This is referred to as Chain Dialing (See page 26.)

Selecting a Different Channel

If you encounter interference while using your phone, you can manually change the phone's channel for clear operation. This function works only when the phone is in use.

Press **delete/ch**. "Scanning" appears on the display, indicating the phone is changing to another channel. For more information on interference, refer to "Precautions" on page 44.



Paging is also canceled when the phone receive an incoming call.

Page

To locate the handset (while it's off the base), press **find handset** on the base. The handset beeps for 60 seconds.

Paging is canceled when pressing any handset key, **find handset** on the base or the handset is returned to the base.

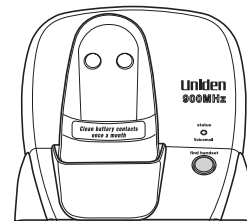

Flash and Call Waiting

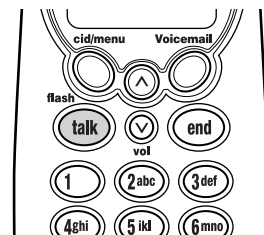

If you have "Call Waiting" service and a call waiting tone sounds while you are on a call, press **talk/flash** to accept the waiting call. There is a short pause, then you will hear the new caller. To return to the original caller, press **talk/flash** again.



You must subscribe through your local telephone company to receive Call Waiting Service.

Storing Phone Numbers and Names

Memory Dialing allows you to dial a number using just a few key presses. Your EXT176 series stores up to 10 names/numbers in the handset.

- 1) Press and hold **mem** until "Memory Store" is displayed.
- 2) Press **^** or **v**, or enter a number (**0 - 9**) to select the memory location where you would like to store the number.
- 3) Press **select**. The following screen appears and a cursor flashes indicating that the display is ready for the name to be entered.

If this screen appears, the selected memory location is already stored. Then you must either edit the entry in this location, delete the entry in this location, or select "Go Back" to choose another location.

- 4) To enter a name (up to 14 characters), use the number keys.

- See the "Steps for entering names and special characters". (See pages 23-24)
- Use **#/>** and ***/tone/<** to move the cursor to the desired location.
- Use **delete/ch** to delete characters as needed.
- Press and hold **delete/ch** to delete all the characters.
- If a name is not required, go to step 5.

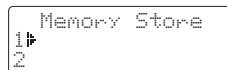

```
Memory Store
1|
2
```

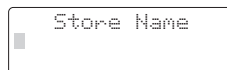

```
Store Name
|
```

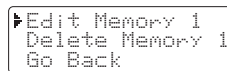

```
Edit Memory 1
Delete Memory 1
Go Back
```



You have 30 seconds after pressing **mem** to enter the number you wish to store. Otherwise, an error tone will sound.



The pause feature is useful for long distance calling, credit card dialing, or sequences that require a pause between digits.

5) Press **select**. "Store Number" is displayed.
The cursor flashes indicating that the display is ready for the number to be entered.

```
Store Number
█
```

6) Use the number keys to enter the phone number.
The phone number cannot exceed 20 digits.
Use **redial/p** to enter a pause in the dialing sequence.
The display shows a "P". Each pause counts as one digit and represents a two second delay of time between the digits.
Use **delete/ch** to delete digits as needed.

```
Store Number
8002971023█
```

7) Press **select**. You will hear a confirmation tone, and the following screen appears. Memory storage is complete.
For example, if you store a name and number into memory location number 7, the display shows "Memory 7 Stored".
After about 2 seconds, "Memory Store" is displayed.
Repeat steps 2 - 7 to store more numbers.

```
Memory 7 Stored
```

```
Memory Store
7▶UNIDEN CORP
8 <Memory 8>
```

8) Press **end** to return to standby mode.

Steps for Entering Names and Special Characters

Refer to the letters on the number keys to select the desired characters.

With each press of a numeric key, the displayed character appears in the following order: Upper case letters first, lower case letters next and finally the number corresponding to the key.

| | Number of times key is pressed | | | | | | | | |
|-------|--------------------------------|---|---|---|---|---|---------|---|---|
| keys | 1 | 2 | 3 | 4 | 5 | 6 | 7 | 8 | 9 |
| 1 | 1 | | | | | | | | |
| 2abc | A | B | C | a | b | c | 2 | | |
| 3def | D | E | F | d | e | f | 3 | | |
| 4ghi | G | H | I | g | h | i | 4 | | |
| 5jkl | J | K | L | j | k | l | 5 | | |
| 6mno | M | N | O | m | n | o | 6 | | |
| 7pqrs | P | Q | R | S | P | q | r | s | 7 |
| 8tuv | T | U | V | t | u | v | 8 | | |
| 9wxyz | W | X | Y | Z | w | x | y | z | 9 |
| 0 | * | # | - | & | (|) | (blank) | 0 | |

If you make a mistake while entering a name

Use ***/tone/**< or **#/>** to move the cursor to the incorrect character.

Press **delete/ch** to erase the wrong character, then enter the correct character.

To delete all characters, press and hold **delete/ch**.

For example, to enter **Uniden**;

- 1) Pick up the handset and press and hold **mem**.
- 2) Enter a number or press **^**, **v** to select a memory location number.
- 3) Press **select**.
- 4) Press **8** twice.
- 5) Press **6** five times.
- 6) Press **4** six times.
- 7) Press **3** four times, then press **#/>** to move the cursor to the right.



If the next character uses the same number key, you must press **#/>** to move the cursor over. Otherwise the next time you press the number key, it changes the character that was previously set.

- 8) Press **3** five times.
- 9) Press **6** five times.
- 10) When finished, press **select**.

To continue to store the telephone number, proceed to step 6 on page 22.

Making Calls with Memory Dialing

Memory dialing from Standby Mode

1) Press **mem**.

The handset displays your programmed memory locations.

```
1 UNIDEN CORP
2 JOHN DOE
3 MOM AND DAD
```

2) Press **∨** or **∧**, or enter the number (**0 - 9**) to select the memory location you would like to dial.

3) Press **talk/flash**. "Talk" and the volume setting appear on the display. Then the displayed number is dialed.

```
-TALK-
0123456789012
```

Display a Programmed Number

Use **#/>** and ***/tone/<** to toggle between the names display and the numbers display.

Program name

Program number

```
1 UNIDEN CORP
2 JOHN DOE
3 MOM AND DAD
```



```
1 8002971023
2 5452930
3 8175551212
```



When the stored phone number has 15 or more digits, "→" is displayed next to the 13th digit. Press **#/>** to see the extra digits and ***/tone/<** to return.

```
5 012345678901
6 0118135543290→
7
```



- If you press **select** before **talk/flash**, you can confirm the name and the number stored in the selected memory location.
- To exit the memory function without dialing, press **end**. The handset returns to standby.
- Whenever you are using a memory menu screen, you must press a key within 30 seconds or the phone will return to standby.



If you select a memory location that does not have a stored number, the handset will beep rapidly and the phone will not dial.

Memory dialing from Talk Mode

- 1) Press **talk/flash**. "Talk" and the volume setting appears.
- 2) Press **mem**.
- 3) Enter a number (**0 - 9**) to select the memory location of the desired phone number. The selected phone number is displayed. Then the number is dialed.
- 4) To hang up, press **end**.

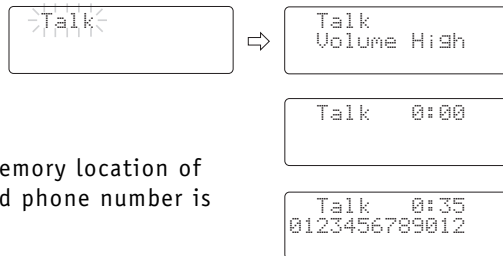

Chain Dialing

The memory locations on the handset are not limited to phone numbers. You can also store a group of numbers (up to 20 digits) that you need to enter once your call connects. This is referred to as Chain Dialing.

An example of this is a bank account number. Once you have called your bank, and are prompted to enter the account number, simply press **mem** and the location number where the special number has been stored.

Store your special number with an identifying name. (Refer to "Storing Phone Numbers and Names" on page 21.)

Editing a Stored Name and/or Phone Number

1) Press and hold **mem** until "Memory Store" is displayed.

```
Memory Store
1 UNIDEN CORP
2 JOHN DOE
```

2) Press **^** or **v**, or enter a number (**0 - 9**) to select the memory location you would like to edit.

3) Press **select**.

The following screen appears with the memory location number that you have selected in the display.

```
Edit Memory 2
Delete Memory 2
Go Back
```

4) Press **^** or **v** to select "Edit Memory", then press **select**.

The following screen appears. The cursor flashes indicating that the display is ready for the name to be edited. When a name has not been stored, the cursor appears at the beginning of the second line.

```
Store Name
UNIDEN CORP
```

5) Use the number keys, ***/tone/ <**, **#/ >**, or **delete/ch** to edit the name. (See page 23.)

To edit only the phone number, skip this step.

6) Press **select**. The following screen appears.

The cursor flashes indicating that the display is ready for the number to be edited.

```
Store Number
8002971023
```

- 7) Use the number key, **redial/p** or **delete/ch** to edit the phone number.
The phone number cannot exceed 20 digits. (See page 22.)
If you don't want to change the phone number, skip this step.
- 8) Press **select**. You hear a confirmation tone, and the following screen appears. The memory storage is complete. For example, if you store a name and number into memory location number 1, the display shows "Memory 1 Stored". After about 2 seconds, "Memory Store" is displayed.
- 9) Press **end** to return to standby mode.

```
Memory 1 Stored
```

```
Memory Store  
1▶UNIDEN CORP  
2 JOHN DOE
```

Erasing a Stored Name and Phone Number

- 1) Press and hold **mem** until "Memory Store" is displayed.
- 2) Press **^** or **v**, or enter a number (**0 - 9**) to select the memory location you would like to erase.
- 3) Press **select**.
The following screen appears with the memory location number that you have selected in the display.
- 4) Press **v** to move the pointer down to "Delete Memory".
- 5) Press **select**. The following confirmation screen appears.
- 6) Press **^** to move the pointer to "Yes".
- 7) Press **select** or **delete/ch**.
You hear a confirmation tone, and the following screen appears.
- 8) After about 2 seconds, the display returns to the "Memory Store" screen.
You may delete the information in another memory location (return to step 2) or press **end** to return to standby mode.

```
Memory Store  
1 UNIDEN CORP  
2 JOHN DOE
```

```
Memory Store  
1 UNIDEN CORP  
2 JOHN DOE
```

```
Edit Memory 2  
Delete Memory 2  
Go Back
```

```
Edit Memory 2  
Delete Memory 2  
Go Back
```

```
Delete Memory 2?  
Yes  
No
```

```
Memory 2 Deleted
```

```
Memory Store  
2 MOM AND DAD  
3
```



You must subscribe to voice mail service from your telephone company in order to use this feature. The voice mail service company will provide you with the access number.

Using One Touch Voice Mail Access

If you subscribe to voice mail service, you can use your phone to access your voice mailbox. The **status/Voicemail** indicator on the base of your phone flashes whenever you have messages waiting in your voice mailbox. Just program the **VoiceMail** key with your access number and you can get your messages at the touch of a button. (The voice mail service provider will supply you with the access number. This number may be simply a phone number. Refer to the provider's literature.)

Programming your Voice Mail Access Number

- 1) On the handset, press and hold **VoiceMail** for about 2 seconds. The following display appears:

```
Store Number
```

If you have previously stored a number, the following display appears:

Press **^** or **v** to select "Edit Number", then press **select**.

```
► Edit Number  
Delete Number  
Go Back
```

- 2) Enter your personal access number.
- 3) Press **select**. A confirmation tone sounds and the following display appears:

```
Number Stored
```

Deleting your Voice Mail Access Number

- 1) When the phone is standby mode, press and hold **Voicemail**. Following display appears.
- 2) Press \wedge or \vee to select "Delete Number".
- 3) Press **select**. Following display appears.
- 4) Press \wedge to move the pointer to "Yes".
- 5) Press **select** or **delete/ch**.
A confirmation tone sounds and the following display appears. After about 2 seconds, the handset returns to standby mode.

```

▶ Edit Number
  Delete Number
  Go Back
  
```

```

Delete Number?
  Yes
▶ No
  
```

```

Number Deleted
  
```

Dialing your Voice Mail Service

Once you've programmed your personal access number, you can dial your mailbox with a touch of a button. When you have messages, simply pick up the handset and press **Voicemail**. If you have not entered the access number or it has been deleted, when you press **Voicemail**, an error tone sounds.

Message Waiting Indicator

The **status/Voicemail** LED indicator on the base is designed to work with voice mail service provided by your local telephone company. The indicator flashes when you have new voice messages in your mailbox.

You may need to occasionally reset the indicator if it remains On after you retrieved your messages. To reset the indicator, charge the handset and press and hold **find handset** on the base for 2 seconds until the indicator stops flashing.



- If you answer a call before the Caller ID message is received (Example: before the second ring), the Caller ID message will not appear.
- When the call is received via a telephone company that does not offer Caller ID service, the caller's phone number and name do not appear. (This includes international calls.)
- When the call is via a private branch exchange (PBX), the caller's phone number and name may not appear.

Caller ID

You must subscribe to Caller ID service to use this feature.

When the telephone rings, the Caller ID feature allows you to view the caller's name and phone number on the display before you answer the phone.

The handset displays the phone number of the incoming call, the name, and time. Additionally, you can dial the displayed number and store the information for memory dialing. Make sure you have turned on the Caller ID/Call Waiting feature. (See page 14.)

When the Telephone Rings

- 1) When the Caller ID message is received, the display shows the caller's phone number along with the date and time. The incoming call information is stored in the Caller ID record. If the Caller ID service includes the caller's name, the caller's name appears on the display (up to 15 letters).

The date and time received — 5/11 12:30PM
Caller's name — UNIDEN CORP
Caller's phone number — 800-297-1023

Here are some typical displays;

When the phone number and name data are received

```
5/11 12:30PM  
UNIDEN CORP  
800-297-1023
```

When invalid data is received

```
Incomplete Data
```

When a private name is received

```
5/11 12:30PM  
Private Name  
800-297-1023
```

When a private number is received

```
5/11 12:30PM  
UNIDEN CORP  
Private Number
```

When an unknown name is received When an unknown number is received

```
5/11 12:30PM
Unknown Name
800-297-1023
```

```
5/11 12:30PM
UNIDEN CORP
Unknown Number
```

2) When you pick up the phone, the display changes to "Talk". (AutoTalk feature is set to on.)

 Data errors appear as "■".

Viewing the Caller ID Message List

The Caller ID list stores information for up to 30 incoming calls - even unanswered calls.

1) Press **cid/menu**.

The summary screen appears.

The screen shows the number of new messages and total messages.

```
New :01
Total:02
```

2) Press **▼** to display the latest Caller ID message.

```
5/17 12:30PM 03
UNIDEN CORP
800-297-1023
```

3) Press **▼** to see the next message. Or press **▲** to see previous message.

4) Press **end** to return to standby mode.



- In Caller ID operation, if no key is pressed for more than 30 seconds, an error tone sounds and the telephone returns to the standby mode.
- If a call comes in via a telephone system that does not offer Caller ID service, no information is stored.
- Each message can be up to 15 characters for the phone number and the name.
- The number of calls from the same Caller ID appears next to the received time. Once you read the new message, the number will disappear.



- While using the "Delete All?" or "Delete Message?" screen if no key is pressed for more than 30 seconds, an error tone sounds and the telephone returns to standby.
- If you get an incoming call or page, the deleting operation is canceled and you can answer the call or page.

Deleting Information from the Caller ID List

The EXT176 series stores up to 30 messages. If the phone receives the 31st message, the oldest one in the list is automatically deleted. Caller ID data can also be deleted manually.

Deleting a Caller ID message

- 1) Press **cid/menu**. Display the message to be deleted from the Caller ID list by pressing **^** or **v**.
- 2) Press **delete/ch**.
- 3) Press **^** or **v** to select "Yes" or "No".
- 4) Press **select** or **delete/ch**.

```
5/17 12:30PM 03
UNIDEN CORP
800-297-1023
```

```
Delete Message?
▶ Yes
No
```

When the pointer is at "Yes":

A tone sounds and the Caller ID message is deleted. The next Caller ID message is then displayed.

When the pointer is at "No":

The display returns to the Caller ID message.

Deleting all Caller ID names/numbers

- 1) Press **cid/menu**.
- 2) Press **delete/ch**.

```
New :01
Total:02
```

3) Press \wedge or \vee to select "Yes" or "No".

```
Delete All?  
  Yes  
# No
```

4) Press *select* or *delete/ch*.

When the pointer is at "Yes":

A tone sounds and all stored Caller ID messages are deleted.

```
Total:00
```

When the pointer is at "No":

The display returns to the summary screen.

```
New :01  
Total:02
```



- You cannot make a call from the Caller ID list if your EXT176 series is connected to private branch exchange (PBX).
- When a long distance call has been set, "1" appears in the display.

Using the Caller ID List

Calling a party from the Caller ID list

You can place a call from the Caller ID list. The EXT176 series stores up to 30 messages.

- 1) Press **cid/menu**. Select the phone number that you want to dial by pressing **^** or **v**.
- 2) Press **talk/flash**. The displayed phone number dials automatically.

```
5/17 12:30PM 03  
UNIDEN CORP  
800-297-1023
```

```
Talk  
8002971023
```

Long Distance calls and Area Code Setting/Cancellation

Pressing **1** while the incoming Caller ID information is displayed (in step 1) will place the prefix "1" in the display to set up for a long distance call. Pressing **3** will set or cancel an area code setting.

Dial edit

You can temporarily edit the Caller ID number that is displayed by pressing **select**. A cursor appears in the display. Press **delete/ch** to move the cursor left, make your changes and then press **talk/flash**. This will not change the number in the Caller ID list memory.

Storing Caller ID messages in Memory dialing

Messages shown in the Caller ID list can be stored in memory dialing. Using the incoming call information (i.e., Caller ID list), the phone number of the party on the Caller ID list can be stored in memory.

1) Press **cid/menu**.

Select the phone number to be stored from the Caller ID list by pressing **^** or **v**.

```
5/17 12:30PM 03
UNIDEN CORP
800-297-1023
```

2) Press **mem**.

```
Select Location
1 |
2 JONE DOE
```

3) Press **^** and **v** or enter a number (**0 - 9**) to select the memory location to be stored.

4) Press **select**.

You hear a confirmation tone, and the number is stored in memory.

```
5/17 12:30PM 03
UNIDEN CORP
800-297-1023
```

The display returns to the Caller ID list.



If a message has already been stored in the selected memory number location, a confirmation screen is displayed. Press **^** to select "Yes". Press **select** to overwrite. The display returns to the Caller ID list.

```
Replace Memory?
Yes
| No
```



You can not store a Caller ID message if no phone number appears in the message.



If the handset battery pack is completely discharged or the battery pack is removed, the digital security code will be lost. If this happens, a new security code is set automatically next time the battery pack is charged.

Changing the Digital Security Code

The digital security code is an identification code used to connect the handset and the base unit. Normally, setting the code is not necessary.

The first time you charge your handset, the security code is automatically set. (See "About the digital security code", page 6.)

In the rare situation that you suspect another cordless telephone is using the same security code, you can change the code.

- 1) Remove the handset from the base unit. Press and hold **find handset** on the base.
- 2) The handset begins emitting a paging sound. While holding **find handset**, place the handset in the base unit. The paging sound stops.
Leave the handset in the base for more than 3 seconds. A new random security code is set.

Installing the Beltclip

To attach the beltclip

Insert the beltclip into the holes on each side of the handset. Press down until it clicks.

To remove the beltclip

Pull both sides of the beltclip to release the tabs from the holes.

Headset Installation

Your phone may be used with a genuine Uniden accessory headset (model HS910).

To use this feature, insert headset plug into the headset jack.

Your phone is ready for hands-free conversations.

(Headset may be purchased by calling the Uniden Parts Department or visiting the web site at www.uniden.com)

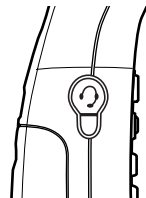

Note on Power Sources

Battery replacement and handling

When the operating time becomes short, even after a battery is recharged, please replace the battery. With normal usage, your battery should last about one year.

Please contact your place of purchase or the Uniden Parts Department for a replacement battery.

Warning: To avoid the risk of personal injury or property damage from fire or electrical shock, only use the Uniden battery model and Uniden adapter model specifically designated for this product.

Power Failure

During the period that the power is off, you will not be able to make or receive calls with the telephone.

Caution

- Use only specified Uniden battery pack (BT-905).
- Do not remove the battery from the handset to charge it.
- Never throw the battery into a fire, disassemble it, or heat it.
- Do not remove or damage the battery casing.

Maintenance

When slightly dirty

Wipe with a soft, dry cloth.

When very dirty

Wipe with a soft cloth that has been dampened with diluted, neutral detergent. Dry with a dry cloth.

When the charging terminals become dirty

Wipe with a dry cloth or a pencil eraser, if necessary.
(See page 10 for the location of charging terminals.)

Caution

Do not use paint thinner, benzene, alcohol, or other chemical products. Doing so may discolor the surface of the telephone and damage the finish.

Troubleshooting

If your phone is not performing to your expectations, please try these simple steps first.

| Symptom | Suggestion |
|--|---|
| The status/Voicemail LED won't illuminate when the handset is placed in the base. | <ul style="list-style-type: none">• Make sure the AC adapter is plugged into the base and wall outlet.• Make sure the handset is properly seated in the base.• Make sure the charging contacts on the handset and base are clean. |
| The audio sounds weak and/or scratchy. | <ul style="list-style-type: none">• Move the handset and/or base to a different location away from metal objects or appliances and try again.• Press delete/ch to help eliminate background noise.• Make sure that you are not too far from the base. |
| Can't make or receive calls. | <ul style="list-style-type: none">• Check both ends of the base telephone line cord.• Make sure the AC adapter is plugged into the base and wall outlet.• Disconnect the AC adapter for a few minutes, then reconnect it.• Change the digital security code (See page 38).• Make sure that you are not too far from the base. |

| Symptom | Suggestion |
|---|---|
| The handset doesn't ring or receive a page. | <ul style="list-style-type: none"> • The battery pack may be weak. Charge the battery for 15-20 hours. • The handset may be too far away from the base unit. • Place the base unit away from appliances or metal objects. • Change the digital security code (See page 38). |
| Severe noise interference. | <ul style="list-style-type: none"> • Keep the handset away from microwave ovens, computers, remote control toys, wireless microphones, alarm systems, intercoms, room monitors, fluorescent lights, and electrical appliances. • Move to another location or turn off the source of interference. |
| The Caller ID does not display. | <ul style="list-style-type: none"> • The handset was picked up before the second ring. • The call was placed through a switch board. • Call your local telephone company to verify your Caller ID service is current. • Charge the handset. |
| If you still have a problem. | <ul style="list-style-type: none"> • Call our customer hotline at 1-800-297-1023. |

Liquid Damage

Moisture and liquid can damage your cordless phone. In case of accidental submersion, please read the following steps.

| Case | Action |
|--|---|
| If the handset or base is exposed to moisture or liquid, but only affects the exterior plastic housing. | Wipe off the liquid and use as normal. |
| If moisture or liquid has entered the plastic-housing (i.e. liquid can be heard in the phone or liquid has entered the battery compartment). | <ol style="list-style-type: none">1. Remove the battery cover of the handset and leave it off for ventilation.2. Remove the battery pack by disconnecting.3. Leave the battery cover off and the battery pack disconnected for 3 days for maximum drying time.4. Once completely dry, reconnect the battery pack and the battery cover.5. Recharge the handset's battery pack for 20 hours in the base unit before using the phone. <p>IMPORTANT: You must unplug the telephone line while recharging the battery pack to avoid charge interruption.</p> |
| If the base unit or the handset is submerged or covered in a sticky substance, such as juice. | <p>Handset:</p> <ol style="list-style-type: none">1. Remove the battery cover of the handset and the battery pack by disconnecting.2. Rinse the handset in warm distilled water.3. Let dry for at least 3 days.4. Once completely dry, reconnect the battery pack and the battery cover.5. Recharge the handset's battery pack for 20 hours in the base unit before using the phone. <p>Base:</p> <ol style="list-style-type: none">1. Disconnect the AC adapter from the base unit, ending power supply.2. Disconnect the telephone cord from the base unit.3. Rinse the base in warm distilled water.4. Let dry for at least 3 days. <p>CAUTION: DO NOT use a microwave oven to speed up the drying time. This will cause permanent damage to the handset and the microwave oven.</p> |

General Information

The phone complies with FCC Parts 15 and 68.

Operating temperature: -10° to 50°C (+14°F to +122°F)

AC Adapter Information

AC Adapter part number: AD-310
Input Voltage: 120V AC 60Hz
Output Voltage: 9V DC 210mA

Battery Information

Battery part number: BT-905
Capacity: 600mAH, 3.6V
Battery use time (per charge)
From fully charged
Talk mode duration: 7 hours
Standby mode duration: 14 days



- **To avoid damage to the phone use only Uniden AD-310 and BT-905 with your phone.**
- If the handset is left off of the base, the actual Talk mode duration will be reduced respective to the amount of time the handset is off the base.

Recharge your phone on a regular basis by returning the handset to the base after each phone call. When the operating time becomes short, even after the battery is recharged, please replace the battery. With normal usage, the battery should last about one year.

A replacement Uniden adapter and battery may be purchased at your local Uniden dealer or by contacting the Uniden Parts Department (800) 554-3988. Hours are from 7:00 a.m. to 5:00 p.m. Central Time, Monday through Friday. We can also be reached on the web at www.uniden.com

Specifications, features, and availability of optional accessories are all subject to change without prior notice.

Precautions!

Before you read anything else, please observe the following:

Warning!

Uniden America Corporation DOES NOT represent this unit to be water-proof. To reduce the risk of fire, electrical shock, or damage to the unit, DO NOT expose this unit to rain or moisture.

Rechargeable Nickel-Cadmium Battery Warning

- This equipment contains a rechargeable nickel-cadmium battery.
- Cadmium is a chemical known to the State of California to cause cancer.
- The rechargeable nickel-cadmium battery contained in this equipment may explode if disposed of in a fire.
- **Do not** short-circuit the battery.
- Do not charge the rechargeable nickel-cadmium battery used in this equipment in any charger other than the one designed to charge this battery as specified in the owner's manual. Using another charger may damage the battery or cause the battery to explode.

Rechargeable Nickel-Cadmium Batteries Must Be Recycled or Disposed of Properly

- Uniden voluntarily participates in an RBRC® industry program to collect and recycle nickel-cadmium batteries at the end of their useful life, when taken out of service within the United States. The RBRC® program provides a convenient alternative to placing used nickel-cadmium batteries into the trash or municipal waste stream, which is illegal in some areas.
- Through the RBRC® program, Uniden makes it easy for you to drop off the used battery at local retailers of replacement nickel-cadmium batteries. You may also contact your local recycling center for information on where to return the used battery. Please call 1-800-8-BATTERY for information on Ni-Cd battery recycling in your area. Uniden's involvement in this program is part of its commitment to protecting our environment and conserving natural resources.
- RBRC® is a registered trademark of the Rechargeable Battery Recycling Corporation.



The exclamation point within an equilateral triangle is intended to alert the user to the presence of important operating and maintenance (servicing) instructions in the literature accompanying the appliance.

Important Safety Instructions

When using your telephone equipment, these basic safety precautions should always be followed to reduce the risk of fire, electrical shock, and injury to persons:

1. Read and understand all instructions.
2. Follow all warnings and instructions marked on the product.
3. Unplug this product from the wall outlet before cleaning. Use a dry

- cloth for cleaning without liquid or aerosol cleaners.
4. Do not use this product near water; for example, near a bathtub, wash bowl, kitchen sink or laundry tub, in a wet basement, or near a swimming pool.
5. Do not place this product on an unstable cart, stand, or table. The telephone may fall, causing serious damage to the unit.
6. Slots and openings in the cabinet and the back or bottom are provided for ventilation. To protect the product from overheating, these openings must not be blocked or covered. This product should never be placed near or over a radiator or heat register. This product should not be placed in a built-in installation unless proper ventilation is provided.
7. This product should be operated only from the type of power source indicated on the marking label. If you are not sure of the type of power supply to your home, consult your dealer or local power company.
8. Do not allow anything to rest on the power cord. Do not locate this product where the cord will be damaged by persons walking on it.
9. Do not overload wall outlets and extension cords, as this can result in the risk of fire or electrical shock.
10. Never push objects of any kind into this product through cabinet slots. As they may touch dangerous voltage points or short out parts that could result in a risk of fire or electric shock. Never spill liquid of any kind on the product.
11. To reduce the risk of electric shock, do not disassemble this product. Take it to qualified service personnel when service or repair work is required. Opening or removing covers may expose you to dangerous voltages or other risks. Incorrect reassembly can cause electric shock when the appliance is subsequently used.
12. Unplug this product from the wall outlet and refer servicing to qualified service personnel under the following conditions:
 - A. When the power supply cord is damaged or frayed.
 - B. If liquid has been spilled into the product.
 - C. If the product has been exposed to rain or water.
 - D. If the product does not operate normally when following the operating instructions. (Adjust only those controls that are covered by the operating instructions. Improper adjustment of other controls may result in damage and will often require extensive repair work by a qualified technician.)
 - E. If the product has been dropped or the cabinet has been damaged.
 - F. If the product exhibits a distinct change in performance.
13. Do not use the telephone to report a gas leak in the vicinity of the leak.

Additional Battery Safety Precautions

Caution! To reduce the risk of fire or injury to persons by the battery, read and follow these instructions:

1. Use only Uniden battery pack specified in the owner's manual.
2. Do not dispose of the battery pack in a fire. The cell may explode. Check the nickel-cadmium battery disposal package insert for disposal instructions.
3. Do not open or mutilate the battery pack. Released electrolyte is corrosive and may cause damage to the eyes or skin. It may be toxic if swallowed.
4. Exercise care in handling the battery in order not to short the bat-

- tery with conducting materials such as rings, bracelets, and keys. The battery or conductor may overheat and cause burns.
5. Charge the battery pack provided with or identified for use with this product only in accordance with the instructions and limitations specified in the owner's manual provided for this product.
6. Observe proper polarity orientation between the battery pack and battery charger.

SAVE THESE INSTRUCTIONS!

Important Electrical Considerations

Unplug all electrical appliances when you know an electrical storm is approaching. Lightning can pass through your household wiring and damage any device connected to it. This phone is not explosion.

Warning!

Please do not attempt to unplug any appliance during an electrical storm.

The FCC Wants You To Know

Changes or modifications to this product not expressly approved by Uniden, or operation of this product in any way other than as detailed by the owner's manual, could void your authority to operate this product. The equipment cannot be used on public coin phone service provided by the telephone company. Connection to party line service is subject to state tariffs. (Contact the state public utility commission, public service commission or corporation commission for information.)

Range

Your new phone is designed to achieve the maximum possible range by transmitting and receiving according to the highest specifications set forth by the FCC. We have rated this phone to operate at a maximum distance with the qualification that the range depends upon the environment in which the telephone is used. Many factors limit range, and it would be impossible to include all the variables in our rating. The Maximum Range rating of this phone is meant to be used as a means of comparison against other range claims.

Telephone Line Problems

The FCC has granted the telephone company the right to disconnect service in the event that your phone causes problems on the telephone line. Also, the telephone company may make changes in facilities and services which may affect the operation of your unit. However, your telephone company must give adequate notice in writing prior to such actions to allow you time for making necessary arrangements to continue uninterrupted service.

If you are having trouble with your telephone service, you must first disconnect your phone to determine if it is the cause of your problem. If you determine that it is the cause, you must leave it disconnected until the trouble has been corrected.

Radio Interference

Radio interference may occasionally cause buzzing and humming in your cordless handset, or clicking noises in the base. This interference is caused by external sources such as TV, refrigerator, vacuum cleaner, fluorescent lighting, or electrical storm. Your unit is NOT DEFECTIVE. If these noises continue and are too distracting, please check around your home to see what appliances may be causing the problem. In addition,

we recommend that the base not be plugged into a circuit that also powers a major appliance because of the potential for interference. Be certain that the antenna on the unit is fully extended when needed. In the unlikely event that you consistently hear other voices or distracting transmissions on your phone, you may be receiving radio signals from another cordless telephone or other source of interference. If you cannot eliminate this type of interference, you need to change to a different channel.

Finally, it should be noted that some cordless telephones operate at frequencies that may cause interference to nearby TVs and VCRs. To minimize or prevent such interference, the base of the cordless telephone should not be placed near or on top of a TV or VCR. If interference is experienced, moving the cordless telephone farther away from the TV or VCR will often reduce or eliminate the interference.

More Than One Cordless Telephone

If you want to use more than one cordless telephone in your home, they must operate on different channels. Press the channel key to select a channel that provides the clearest communication.

Cordless Telephone Privacy

Cordless telephones are radio devices. Communications between the handset and base of your cordless telephone are accomplished by means of radio waves which are broadcast over the open airways. Because of the inherent physical properties of radio waves, your communications can be received by radio receiving devices other than your own cordless telephone unit. Consequently, any communications using your cordless telephone may not be private.

Installation Considerations

Selecting a Location

Before choosing a location for your new phone, there are some important guidelines you should consider:

- The location should be close to both a phone jack and continuous power outlet. (A continuous power outlet is an AC outlet which does not have a switch to interrupt its power.)
- Keep the base and handset away from sources of electrical noise such as motors or fluorescent lighting.
- Be sure there is sufficient space to fully extend the base antenna.
- The base can be placed on a desk or tabletop or mounted on a standard telephone wall plate.
- You should charge your new phone for 15-20 hours before completing the installation or using the handset.

Telephone Line Outlets

There are two types of phone outlets:

Modular Jack

Most phone equipment available now uses modular jacks. Phone cords are fitted with a molded plastic connector which plugs into this type of jack. If you do not have modular phone jacks, contact your local telephone company for information about their installation.

Hardwired Jack

Some equipment is wired directly to a phone jack, and these types of installations require a modular jack converter. This type of installation is not difficult; however, you should contact your Uniden telephone dealer or a telephone supply store for advice about the proper adapter or con-

verter for your particular situation.

Connecting the Telephone Cords

Consider these safety guidelines before connecting the telephone cords:

Caution!

- Never install telephone wiring during a lightning storm.
- Never touch uninsulated telephone wires or terminals unless the telephone line has been disconnected.
- Use caution when installing or modifying telephone lines.

Applying Power to the Base

This phone requires an AC outlet, without a switch to interrupt power, and the included AC adapter. To relieve strain on the DC plug when the phone is placed on a desk or table, wrap the power cord around the strain relief notch on the bottom of the base.

NOTE: Place the power cord so that it does not create a trip hazard, or where it could become chafed and create a fire or other electrical hazards.

Adapter Safety Features

If the AC adapter furnished with this phone has a polarized line plug (a plug having one blade wider than the other), this plug will fit into the power outlet only one way. If you are unable to insert the plug fully into the outlet, try reversing the plug.

Do not alter the shape of the blades of the polarized plug!

NOTE: If you cannot plug the AC adapter into the outlet, contact someone about replacing the outlet.

Plug the AC Adapter into a standard 120 VAC wall outlet.

Do not use an outlet controlled by a wall switch.



Use only the Uniden AC Adapter supplied with this phone.

One Year Limited Warranty

Important: Evidence of original purchase is required for warranty service.

WARRANTOR: UNIDEN AMERICA CORPORATION ("Uniden")
ELEMENTS OF WARRANTY: Uniden warrants, for one year, to the original retail owner, this Uniden Product to be free from defects in materials and craftsmanship with only the limitations or exclusions set out below.

WARRANTY DURATION: This warranty to the original user shall terminate and be of no further effect 12 months after the date of original retail sale. The warranty is invalid if the Product is (A) damaged or not maintained as reasonable or necessary, (B) modified, altered, or used as part of any conversion kits, subassemblies, or any configurations not sold by Uniden, (C) improperly installed, (D) serviced or repaired by someone other than an authorized Uniden service center for a defect or malfunction covered by this warranty, (E) used in any conjunction with equipment or parts or as part of any system not manufactured by Uniden, or (F) installed or programmed by anyone other than as detailed by the owner's manual for this product.

STATEMENT OF REMEDY: In the event that the product does not conform

to this warranty at any time while this warranty is in effect, warrantor will either, at its option, repair or replace the defective unit and return it to you without charge for parts, service, or any other cost (except shipping and handling) incurred by warrantor or its representatives in connection with the performance of this warranty. Warrantor, at its option, may replace the unit with a new or refurbished unit. **THE LIMITED WARRANTY SET FORTH ABOVE IS THE SOLE AND ENTIRE WARRANTY PERTAINING TO THE PRODUCT AND IS IN LIEU OF AND EXCLUDES ALL OTHER WARRANTIES OF ANY NATURE WHATSOEVER, WHETHER EXPRESS, IMPLIED OR ARISING BY OPERATION OF LAW, INCLUDING, BUT NOT LIMITED TO ANY IMPLIED WARRANTIES OF MERCHANTABILITY OR FITNESS FOR A PARTICULAR PURPOSE. THIS WARRANTY DOES NOT COVER OR PROVIDE FOR THE REIMBURSEMENT OR PAYMENT OF INCIDENTAL OR CONSEQUENTIAL DAMAGES.** Some states do not allow this exclusion or limitation of incidental or consequential damages so the above limitation or exclusion may not apply to you.

LEGAL REMEDIES: This warranty gives you specific legal rights, and you may also have other rights which vary from state to state. This warranty is void outside the United States of America.

PROCEDURE FOR OBTAINING PERFORMANCE OF WARRANTY: If, after following the instructions in the owner's manual you are certain that the Product is defective, pack the Product carefully (preferably in its original packaging). The Product should include all parts and accessories originally packaged with the Product. Include evidence of original purchase and a note describing the defect that has caused you to return it. The Product should be shipped freight prepaid, by traceable means, to warrantor at:

Uniden America Corporation

Parts and Service Division

4700 Amon Carter Blvd, Fort Worth, TX 76155

(800) 297-1023, 8 a.m. to 5 p.m. Central, Monday through Friday

I.C. Notice

TERMINAL EQUIPMENT

NOTICE: This equipment meets the applicable Industry Canada Terminal Equipment Technical Specifications. This is confirmed by the registration number. The abbreviation, IC, before the registration number signifies that registration was performed based on a Declaration of Conformity indicating that Industry Canada technical specifications were met. It does not imply that Industry Canada approved the equipment.

NOTICE: The Ringer Equivalence Number (REN) for this terminal equipment is marked on the equipment itself. The REN assigned to each terminal equipment provides an indication of the maximum number of terminals allowed to be connected to a telephone interface. The termination on an interface may consist of any combination of devices subject only to the requirement that the sum of the Ringer Equivalence Numbers of all the devices does not exceed five.

RADIO EQUIPMENT

The term "IC:" before the radio certification number only signifies that Industry Canada technical specifications were met.

Operation is subject to the following two conditions: (1) this device may not cause interference, and (2) this device must accept any interference, including interference that may cause undesired operation of the device. "Privacy of communications may not be ensured when using this telephone".

Index

A

- AC adapter information 43
- Adjusting ringer and earpiece volume..... 18

B

- Battery pack
 - Information 43
 - Install 9
 - Maintenance10, 39
 - Preparing and charging 11
 - Replacement and handling 39
- Beltclip installation 38

C

- Caller ID
 - Caller ID service 32
 - Call Waiting 20
 - Deleting 34
 - Setting Caller ID options 14
 - Using 36
 - Viewing..... 33
- Channel 20
- Connection 11

D

- Dial mode..... 15
- Digital security code 6, 38

E, F, G

- Earpiece volume..... 18
- General information 43

H

- Headset installation 38

I, J, K, L

- I.C. Notice 46

- Interference 44

- Language 16

M, N, O

- Maintenance 39
- Making a call 17
- Memory dialing
 - Editing a stored name and/or phone number..... 27
 - Erasing a stored name and phone number..... 29
 - Making calls with memory dialing 25
 - Storing phone numbers and names 21
- Mounting on a wall..... 12

P, Q

- Package contents..... 7
- Paging..... 20
- Precautions..... 44
- Quick reference guide 3

R

- Receiving a call 17
- Redialing a call 17, 19
- Ringer tone and volume..... 18

S

- Setting menu options 14
- Setting up the handset 9
- Setting up the phone 8

T, U, V, W, X, Y, Z

- Troubleshooting..... 40
- Voice mail 30
- Warranty 45

Memo

At Uniden, we'll take care of you!

If you need any assistance with this product, please call our Customer Hotline at

1-800-297-1023

PLEASE DO NOT RETURN THIS PRODUCT TO THE PLACE OF PURCHASE.

Our Uniden representatives will be happy to help you with any matters regarding the operation of this unit, available accessories, or any other related matters.

Thank you for purchasing a Uniden product.

Hours: M-F 8:00 AM to 5:00 PM CST.



For information on the accessibility features of this product, please call

1-800-874-9314 (V/TTY)

The Uniden logo is displayed in a bold, black, sans-serif font. The letter 'i' in 'Uniden' has a distinctive dot that is a small circle. A registered trademark symbol (®) is located at the top right of the 'n'.

May be covered under one or more of the following U.S. patents:

| | | | | | |
|-----------|-----------|-----------|-----------|-----------|-----------|
| 4,511,761 | 4,523,058 | 4,595,795 | 4,797,916 | 5,381,460 | 5,426,690 |
| 5,434,905 | 5,491,745 | 5,533,010 | 5,543,605 | 5,574,727 | 5,581,598 |
| 5,650,790 | 5,660,269 | 5,661,780 | 5,663,981 | 5,671,248 | 5,696,471 |
| 5,717,312 | 5,732,355 | 5,754,407 | 5,758,289 | 5,768,345 | 5,787,356 |
| 5,794,152 | 5,801,466 | 5,825,161 | 5,838,721 | 5,864,619 | 5,893,034 |
| 5,912,968 | 5,915,227 | 5,929,598 | 5,930,720 | 5,960,358 | 5,987,330 |
| 6,044,281 | 6,070,082 | 6,125,277 | 6,253,088 | | |

©2002 Uniden America Corporation, Fort Worth, Texas
Custom manufactured in China.

Contains additional foreign articles.
UCZZ01382DZ

Download from Www.Somanuals.com. All Manuals Search And Download.

Free Manuals Download Website

<http://myh66.com>

<http://usermanuals.us>

<http://www.somanuals.com>

<http://www.4manuals.cc>

<http://www.manual-lib.com>

<http://www.404manual.com>

<http://www.luxmanual.com>

<http://aubethermostatmanual.com>

Golf course search by state

<http://golfingnear.com>

Email search by domain

<http://emailbydomain.com>

Auto manuals search

<http://auto.somanuals.com>

TV manuals search

<http://tv.somanuals.com>