

# Uniden®

## OWNER'S MANUAL



### UNIDEN Model UH013 UHF CB Radio

# Contents

Introduction .....	2
Features .....	2
Preventive Maintenance .....	2
Troubleshooting .....	2
Controls / Connectors .....	3
Indicators .....	4
Included with your UH013 .....	5
Mounting Options .....	6
Operation .....	8
Setting the Squelch .....	8
Monitor .....	8
Selecting a Channel .....	9
Transmitting .....	9
Using Repeater Channels .....	9
Operating the UH013 in Duplex Mode .....	10
Scanning .....	10
Open Scan (OS) Mode .....	10
Group Scan (GS) Mode .....	11
Programming Scan Channels .....	11
Busy Channel Lockout .....	12
VOX Operation (optional VOX headset required) .....	12
Programming the Instant Priority Channel .....	12
Recalling the Instant Channel .....	12
CTCSS (Continuous Tone Coded Squelch System) .....	13
Wide Band Scanning .....	13
Searching .....	14
Scanning Stored Frequencies .....	14
Programming Scan Frequencies .....	14
Selective Calling (Optional Selcall PCB Required) .....	15
Frequency & CTCSS Tone Lists .....	16
Warranty .....	17

# Introduction

The Uniden UH013 is designed to provide you with years of trouble free service. Its rugged components and materials are capable of withstanding harsh environments.

We are certain that you will enjoy your UH013. Please read this Operating Manual carefully to ensure you gain the optimum performance of the unit.

## Features

- Detachable Display Unit
- Transmit & Receive FM 40CH (UHF-CB, TX Power 5w)
- 2 Levels Preset Squelch
- Wide Band Scanner (400MHz - 512MHz) = WS Function
- Band Search Function (4 Bands separately)
- LCD Display with Backlight
- Signal Strength Meter
- RF Power Indicator
- One touch Instant Channel recalling
- Duplex Capability (from CH01 - CH08 per channel)
- Group Scan and Priority Channel Watch
- Open Scan
- Busy Channel Lock-out
- 38 Built-in CTCSS codes
- Volume Control with Power On/Off Switch
- VOX (Voice Activated Function) optional VOX headset required
- 9 Step VOX Mic sensitivity adjustment
- Memory backup if power fails
- Optional Tone Squelch Unit Function
- Tone Squelch Function (5/6 Tone) optional
- Tone Calling Function (5/6 Tone) optional
- Tone Squelch Scan optional

**Preventive Maintenance:** The following system checks should be made every six to twelve months:

- Check the Standing Wave Ratio (SWR).
- Inspect the tightness of all electrical connections.
- Inspect the antenna coaxial cable for wear or breaks on the shielding.
- Inspect the tightness of all screws and other mounting hardware.

**Troubleshooting:** Should the unit malfunction or perform poorly, follow these procedures:

If the transceiver is completely inoperative: Check the power cord and fuse.

If there is trouble with receiving: Check the VOLUME control setting. Be sure the SQUELCH is adjusted properly. Possibly the radio is over-squelched.

If there is trouble with transmitting: Check that the transmission line (coaxial cable) is securely connected to the ANTENNA connector. Check that the antenna is fully extended for proper operation. Check that all transmission line (coaxial cable) connections are secure and free of corrosion.

### NOTE

Blackening may occur on the Liquid Crystal Display if the UH013 has been subjected to extreme high temperature (above 60°C). This is not a fault. Normal LCD operation resumes when the temperature stabilizes back to standard operating conditions (0 to 55°C).

# Controls / Connectors

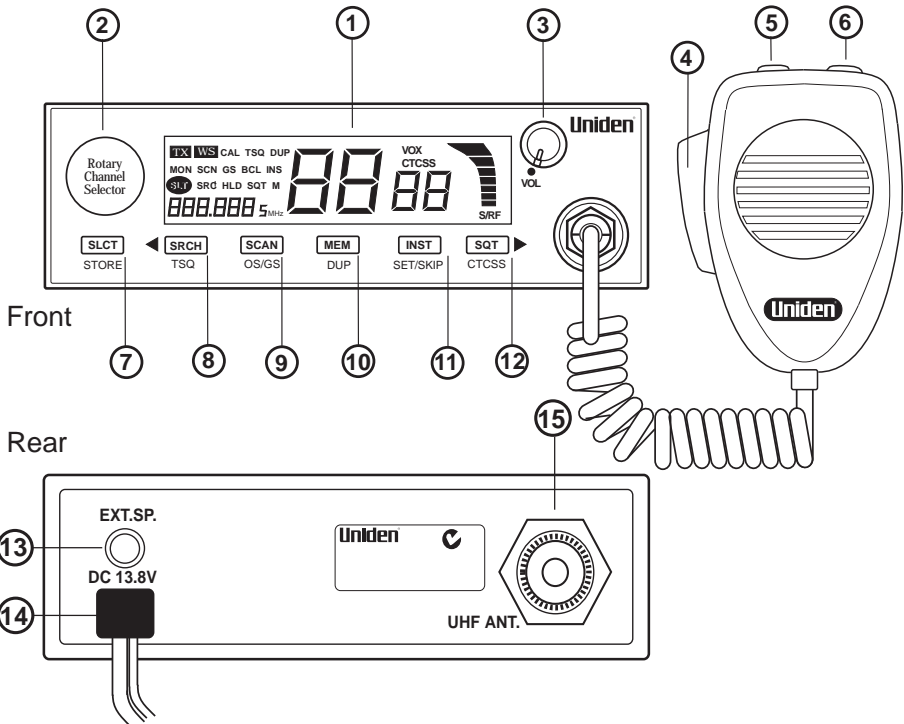

## Controls and Connectors

Ref.	Item	Page	Ref.	Item	Page
①	Liquid Crystal Display (LCD)	4	⑨	SCAN - Open or Group Scan	10, 11
②	Rotary Channel Selector	9	⑩	MEM - Memory Button	11
③	On/Off Volume	8	⑪	INST - Instant Set, Instant Channel Recall and Instant Channel Programming	12
④	Push to Talk (PTT) Button	9	⑫	SQT - Squelch Mode	13
⑤	Tone Call	15	⑬	External Speaker Jack	-
⑥	Monitor Button	8	⑭	Power Input (13.8V DC)	-
⑦	SLCT - Select Button	12, 13	⑮	UHF Antenna Connection	-
⑧	SRCH - Search Button	14			

# Indicators

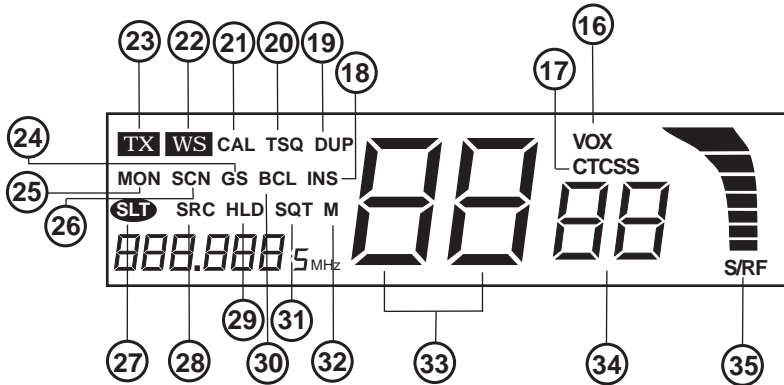

## Indicators

Ref.	Item	Page	Ref.	Item	Page
16	VOX - Voice Operated Microphone	12	26	SCN - Scan	10
17	CTCSS - Continuous Tone Coded Squelch System	13	27	SLT - Select	9
18	INS - Instant Channel	12	28	SRC - Search	14
19	DUP - Duplex	9 - 10	29	HLD - Hold	14
20	TSQ - Tone Squelch (Optional)	9	30	BCL - Busy Channel Lockout	12
21	CAL - Tone Call (Optional)	15	31	SQT - Squelch Tight	8
22	WS - Wide Band Scanner	13	32	M - Memory	14
23	TX - Transmit	9	33	88 - Channel Number	-
24	GS - Group Scan	11	34	88 - CTCSS Code	-
25	MON - Monitor	8	35	S/R/F - RF Signal Strength	-

# Included with your UH013



UH013 Owners Manual

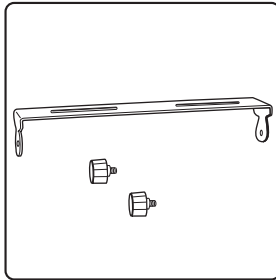

Display Mount Bracket

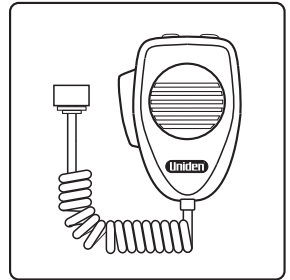

Microphone

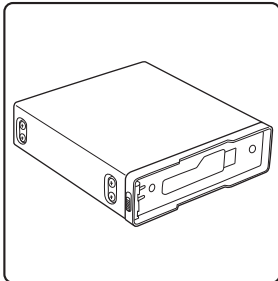

Transceiver

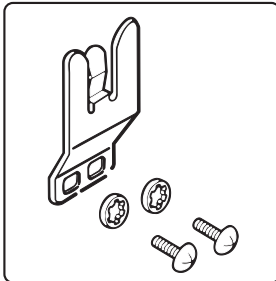

Microphone Hanger, Screws and Washers

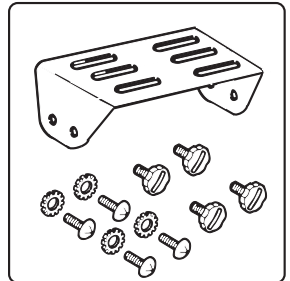

Mounting Bracket, Knobs, Washer Stars and Screws

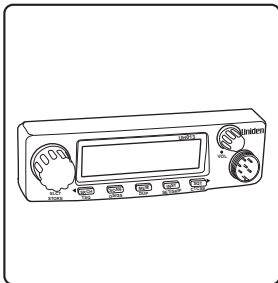

Display Unit

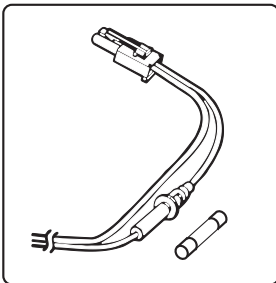

DC Power Cord with Fuse

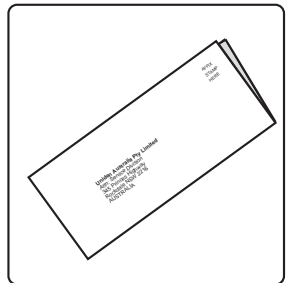

Consumer Support Card

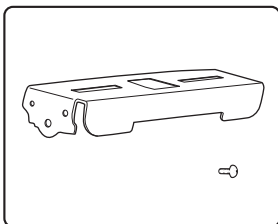

Display Rear Bracket

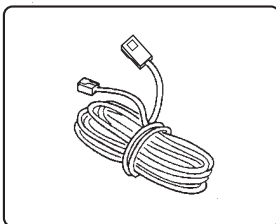

Extension Cable

## Mounting Options

The radio can be mounted complete - or - with the Display Unit remote of the Transceiver.

### Mounting the complete radio (Transceiver with Display Unit)

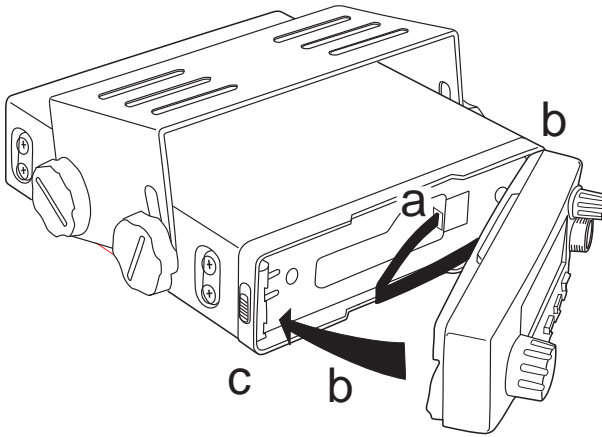

- a) Plug in display cable from the Display Unit to the transceiver.
- b) Hinge the Display Unit into the transceiver as shown in the diagram, then snap closed.
- c) Should you wish, at a later stage, to position the Display Unit remote from the Transceiver, release the Display Unit by pushing up the slide on the side.

### Remote mounting of the Transceiver Unit

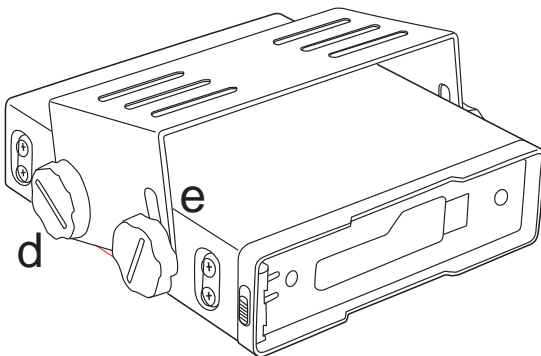

If the Display Unit is not already separate of the Transceiver then remove it as detailed in c) above.

Fix the Transceiver Mounting Bracket in an appropriate location (screws and washers supplied). Then fix the Transceiver in the bracket using the Knob bolts supplied d).

The bracket can be fixed on the top or under the transceiver. An arced slot e) allows you to mount the transceiver at an angle.

## Mounting Options

### Remote mounting of the Display Unit

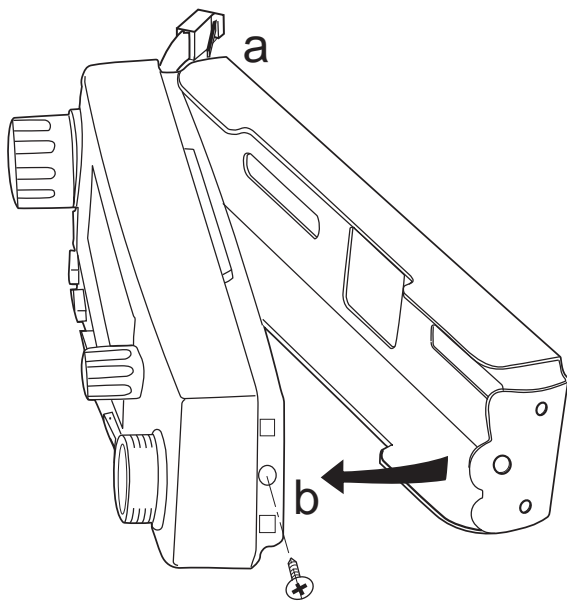

#### Fixing the Display Rear Bracket

To mount the Display Unit it needs to be fitted with a Display Rear Bracket (included in package).

- Position the Display Rear Bracket so that one end fits over the two studs at the end of the Display Unit.
- Push it into place until the fixing screw hole is aligned with its threaded counterpart.
- Secure the Display Rear Bracket with the screw provided.

#### Optional mounting positions

The Display Unit can be mounted from the top, back or bottom.

- Fix the Display Mount Bracket in place (above, at the rear or at the bottom) by screwing through the slots in the bracket.
- Fix the Display Unit to the bracket with the thumb screws provided.
- Connect the Extension Cable between the Display Unit and the Transceiver.

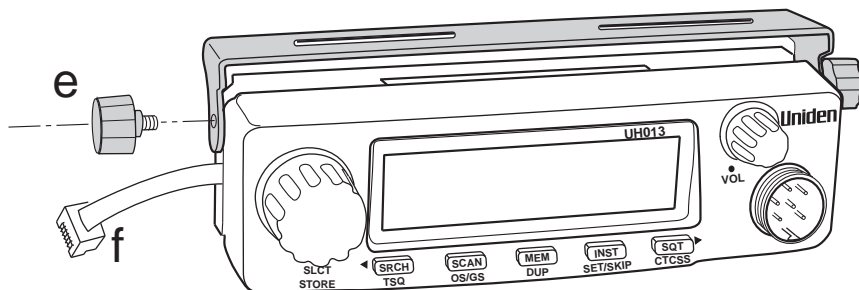
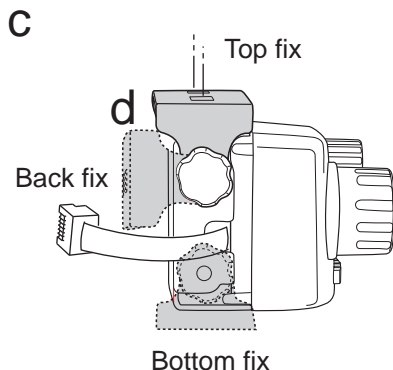



# Operation

## Setting the Squelch

Turn the Unit ON by rotating the volume control clockwise. The UH013 has 2 Levels Preset Squelch. It requires no adjustment. However, if you are in a very high noise area it may break through. Press **[SQT]** to select the tight squelch mode. The SQT icon appears.

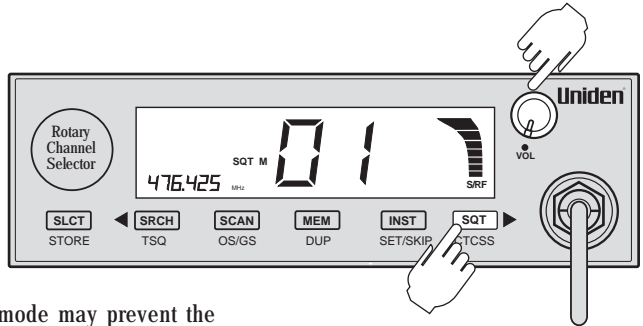

Selecting tight squelch mode may prevent the reception of weak signals.

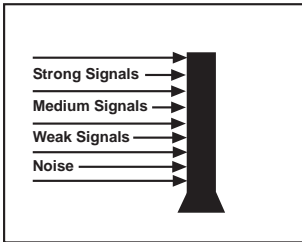

Think of the squelch control as a gate. If the squelch is fully closed no signal can get through.

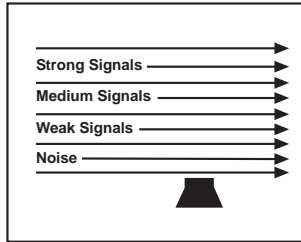

If the squelch is fully open 'Monitor Mode' it allows all signals to get through - weak, medium and strong signals and noise.

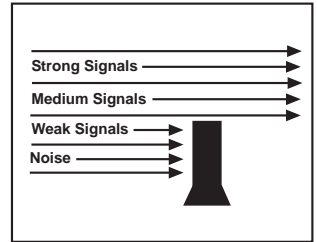

By setting the squelch to 'threshold', it blocks out all weak signals and noise and allows only the required medium and stronger signals to pass through.

Strong noise may still break through. Press **[SQT]** to select the 'Tight Squelch' mode. The SQT icon appears.

## Monitor

Press the MONI button on the microphone to open the squelch and receive all weak signals. Press and hold the MONI button for 2 seconds to hold the squelch open (Monitor Mode). Press MONI again momentarily to cancel.

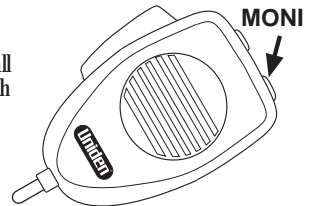

# Operation

## Selecting a Channel

Turn the Rotary Channel Selector to select the desired channel.

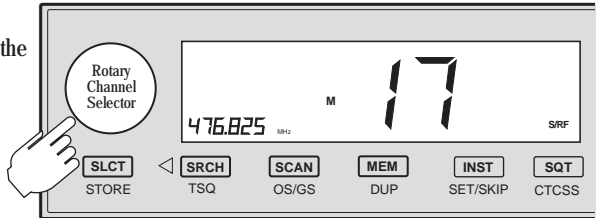

## Transmitting

Select the desired channel. Press the Microphone's PTT button and speak normally into the microphone. Hold it approx. 7cm from your mouth. Release the PTT button to end the transmission and listen for a reply.

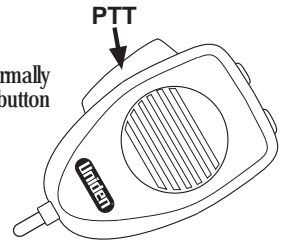

## Using Repeater Channels

UHF CB Repeaters are used to retransmit or relay your signal. Repeaters will extend the range of your radio and overcome the shielding effect caused by solid obstructions. In normal Simplex operation, your radio transmits on one particular frequency and receives on that same frequency. If there is a barrier that partially blocks your transmitted signal, the probability of another radio receiving the signal is very slim. Hills, tall buildings, metallic structures, ... etc. tend to act as a screen between radios.

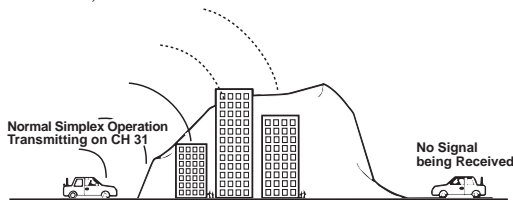

Standard Operation without  
the aid of a Repeater Station

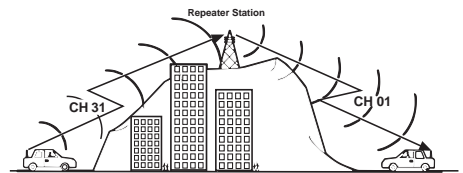

Operation with the aid of  
Repeater Station (Duplex)

The Signal coming from your radio is received by the Repeater Station and then retransmitted at the same time on another channel. This operation is called "Duplexing".

For example,

CH01 on Duplex Mode will Receive on CH 01 but Transmit on CH31

CH02 on Duplex Mode will Receive on CH 02 but Transmit on CH32 etc ....

If you transmit on CH01 Duplex mode, you are actually transmitting on CH31, the repeater station down-converts your signal and retransmits on CH01.

# Operation

## Operating the UH013 in Duplex Mode

For this example we are adopting CH01 as the channel being used in your area for repeater use.

Press and hold **[DUP]** for 2 seconds to switch Duplex ON. The DUP icon appears.

If Duplex is not required - press **[DUP]** and hold for 2 seconds again to switch Duplex off.

Only channels 01 - 08 are available for Duplex

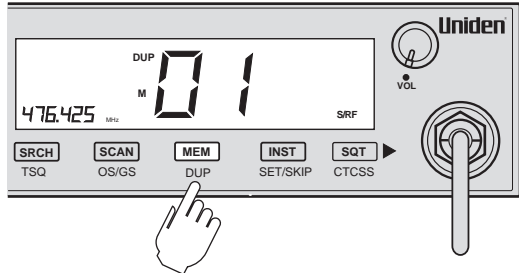

### NOTE

Check with your local Retailer for information on available Repeaters.

## Scanning

The UH013 has a scanning feature that allows you to search for active channels automatically.

Furthermore, the UH013 is designed to have two types of scanning; Open Scanning (OS) and Group Scanning (GS), to give you flexibility and allow you to use the radio more effectively.

Press **[SCAN]** and Scanning starts. The SCN icon appears.

Press **[SCAN]** again to stop scanning.

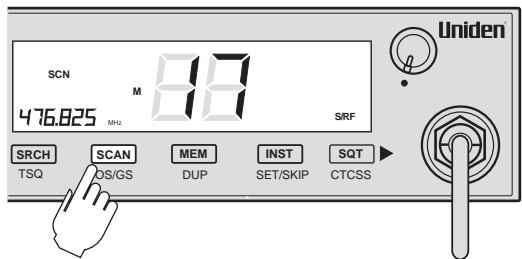

## Open Scan (OS) Mode

Allows continuous scanning of channels stored in the Open Scan memory. If an active channel is found, scanning will stop on that channel.

This example shows CH40 active.

If the received signal ceases, the unit will wait 3 seconds for the signal to return, otherwise scanning resumes.

To skip the active channel, press **[MEM]** momentarily. Scanning resumes. To deactivate SCAN, press **[SCAN]** or the PTT button on the microphone.



### NOTE

If SCAN is deactivated while on an active channel, the UH013 will stay on that active channel. If no channels are active, the UH013 will reinstate the starting channel.

### NOTE

OS Mode is indicated by the absence of the GS icon.

# Operation

## Group Scan (GS) Mode

Allows you to monitor a Priority (Instant) Channel while scanning (Instant Priority channel see p.12)

To use GS Mode Scanning, press and hold **(SCAN)** for 2 seconds. GS icon appears on the display.



GS Scanning checks the Instant Priority Channel for activity regularly.

If the Priority Channel becomes active the radio will stay on that channel for as long as the signal is present. If the received signal ceases, Priority Scanning continues after 3 seconds.

If scanning stops on a channel which is not a Priority Channel, UH013 will continue monitoring the Priority Channel for activity while listening to the active one.

To deactivate SCAN, press the **(SCAN)** button or the PTT button.

Press and hold **(SCAN)** for 2 seconds to turn off Group Scan Mode.

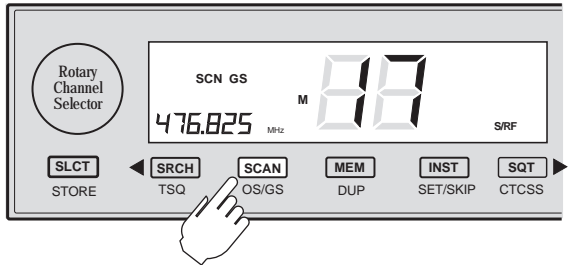

### NOTE

If SCAN is deactivated while it is tuned to an active channel, the UH013 will stay on that active channel. If none of the channels are active, the UH013 will reinstate the Starting Channel.

If SCAN is deactivated while it is tuned to the Instant Priority Channel, the UH013 will remain on the Instant Priority Channel.

### NOTE

If GS Scanning is initiated when there are no channels programmed in GS memory, an error tone will be heard and scanning will not start (see Programming Scan Channels - below).

## Programming Scan Channels

Select which Scanning Mode you wish to use - OS or GS.

Select the channel you want to store.

Press **(MEM)** to store. M icon appears and a short tone beep is heard.

To remove the channel from Memory, press **(MEM)** once more. The M icon disappears.

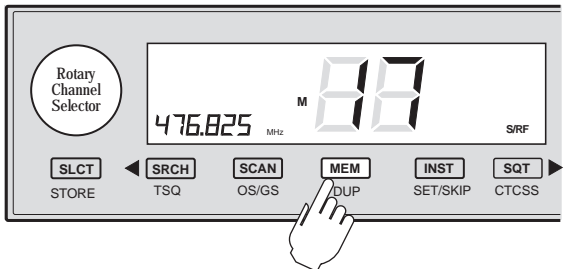

### NOTE

OS is indicated by the absence of the GS icon.

# Operation

## Busy Channel Lockout

If the channel is already in use, you can prevent the UH013 from transmitting. This is particularly important when using CTCSS.

Press **[SLCT]** 2 times. Turn the Rotary Channel Selector to display **ON**. Press and hold **[SLCT]** for 2 seconds to store the new setting.

### NOTE

If a button is not pressed within 10 seconds the UH013 will automatically exit Select Mode.

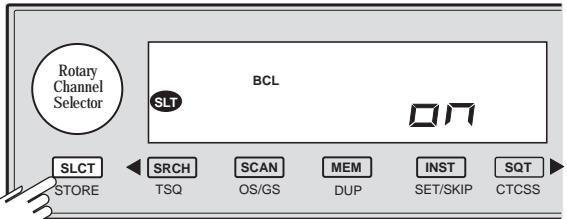

## VOX Operation (optional VOX headset required)

Press **[SLCT]** 3 times. Turn the Rotary Channel Selector to select the desired VOX sensitivity (1 - 9).

Press and hold **[SLCT]** for 2 seconds to store the new setting. Connect the VOX headset.

### NOTE

If a button is not pressed within 10 seconds the UH013 will automatically exit Select Mode.

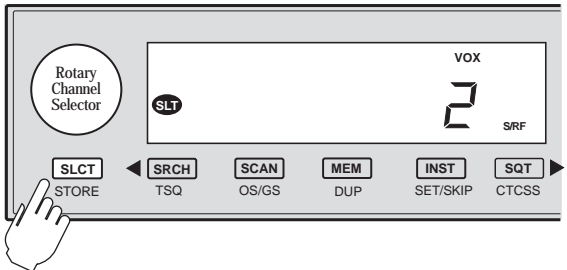

## Programming the Instant Priority Channel

Turn the Rotary Channel Selector to select the Priority Channel you prefer.

Press and hold **[INST]** for 2 seconds to store the new setting. **INS** icon appears.

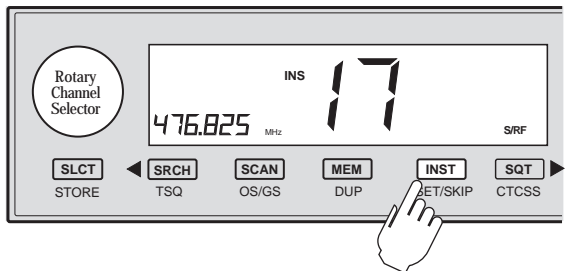

## Recalling the Instant Channel

Momentarily press the **[INST]** key at any time to return to the Instant Channel.

# Operation

## CTCSS (Continuous Tone Coded Squelch System)

Turn the Rotary Channel Selector to the desired channel to use CTCSS. Press and hold **[SQT]** for 2 seconds. CTCSS icon flashes.

Turn the Rotary Channel Selector to select the desired CTCSS code 01 - 38. Press **[SQT]** once to store the new setting.

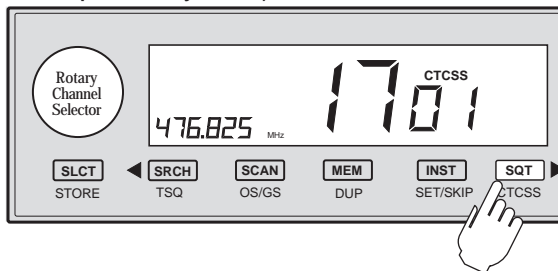

**NOTE** Channels 05 and 35 are Emergency Channels and channel 11 is a Calling Channel. CTCSS cannot be selected on these channels.

**NOTE** If a button is not pressed within 10 seconds the UH013 will automatically exit Select Mode.

## Wide Band Scanning

The UH013 can also scan a wider band of frequencies (Step: 12.5 KHz).

Band	Frequencies
A	400 MHz - 420 MHz
B	420 MHz - 450 MHz
C	450 MHz - 470 MHz
D	470 MHz - 512 MHz

**NOTE** Transmission is not possible on wide band frequencies.

1. Press **[SLCT]** once.
  2. Turn the Channel Selector to select **07**.
  3. Press and hold **[SLCT]** for 2 seconds to store the new setting.
- Searching of band A will immediately begin.

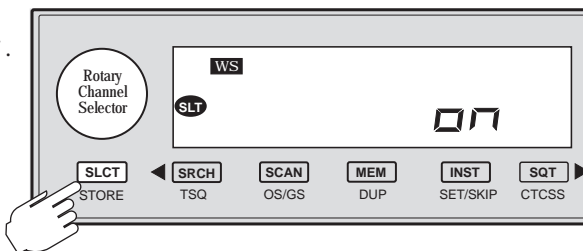

# Operation

## Searching

Searching checks every frequency within the Band. If an active channel is located the UH013 will stop on that channel until 2 seconds after the transmission ends, then continue.

### Search Hold

1. To stop the search, press **[SRCH]** at any time. HLD is displayed.
2. To continue, press **[SRCH]** again.

### Skip

If a particular frequency continues to interrupt searching, you can set your radio to skip the frequency by pressing the **[INST]** button during search hold (you may skip up to 10 frequencies). To cancel Skip, press **[INST]** again while search holding at the desired frequency. To cancel all Skipped frequencies, press and hold **[INST]** for 2 seconds during search hold.

### Changing the Search Band

While searching press and hold **[SRCH]** for 2 seconds. The UH013 will move to the next band.

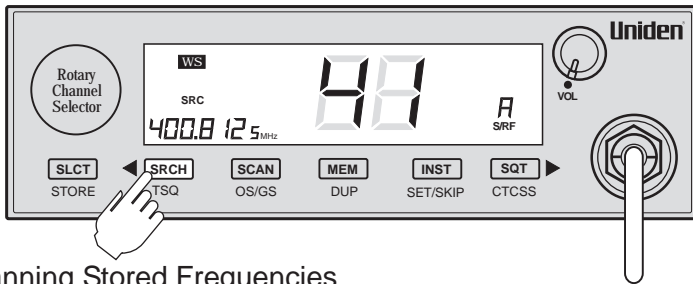

## Scanning Stored Frequencies

You may store up to 40 frequencies from any band into memory and then only scan those frequencies for activity.

1. Select Wide Band Scanning (see page 13).
2. Press **[SCAN]**.
3. To stop the Scan, press **[SCAN]** at any time. HLD is displayed.
4. To continue, press **[SCAN]** again.

## Programming Scan Frequencies

1. Select wide band scanning (see page 13).
2. Press **[SCAN]** and turn the Channel selector to choose a memory location (41 - 80).
3. Press **[SRCH]** to approach the desired frequency.
4. Turn the Channel Selector to stop searching and fine tune to the exact frequency.
5. Press **[MEM]** to store the selected frequency.

### NOTE

Repeat procedure as necessary to programme the other memory locations.

## Deleting stored frequencies

1. Select the desired memory location.
2. Press and hold **[SCAN]** for 2 seconds to delete the selected frequency.

## Selective Calling (Optional Selcall PCB Required)

### Outline

Selective Calling (SELCALL) is a special Sequential Tone Squelch System that allows the user to receive/transmit calls selectively from/to an individual or group, on a shared busy channel.

The UH013 has an Optional Selective Calling system.

Exceptional features, like Receiver Quieting, Tone Squelch Scanning, Tone and Group Calling make the UH013 superior to any transceivers in its class.

### Receiver Quieting (Tone Squelch)

When activated, it automatically mutes the receiver audio circuit of the radio.

It will stay in this 'Quiet' mode as long as the SELCALL tone code (SELCALL ID) required to open the muting circuit is not received.

### Call Alarm

When a received code matches to your SELCALL ID, an alarm (CA Alert) will be emitted informing you that a caller is on the channel.

### Tone Squelch Scanning

Scans only tone squelched Channels.

### Tone Calling

Allows you to selectively call another radio.

### Group Calling Capability

Transmits and Responds to Group Calls.



## Frequency & CTCSS Tone Lists

### FM UHF - CB Frequency List - Australia & New Zealand

CH No.	Simplex Mode Transmit / Receive Frequency (MHz)	Duplex Mode Transmit Frequency (MHz)	CH No.	Simplex Mode Transmit / Receive Frequency (MHz)
01	476.425	477.175 CH31	21	476.925
02	476.450	477.200 CH32	22	476.950
03	476.475	477.225 CH33	23	476.975
04	476.500	477.250 CH34	24	477.000
05	476.525	477.275 CH35	25	477.025
06	476.550	477.300 CH36	26	477.050
07	476.575	477.325 CH37	27	477.075
08	476.600	477.350 CH38	28	477.100
09	476.625		29	477.125
10	476.650		30	477.150
11	476.675		31	477.175
12	476.700		32	477.200
13	476.725		33	477.225
14	476.750		34	477.250
15	476.775		35	477.275
16	476.800		36	477.300
17	476.825		37	477.325
18	476.850		38	477.350
19	476.875		39	477.375
20	476.900		40	477.400

NOTE: Channel 05 and 35 are Emergency Channels and channel 11 is a Calling Channel.

### CTCSS TONE List

Tone No.	Tone Frequency (Hz)	Tone No.	Tone Frequency (Hz)	Tone No.	Tone Frequency (Hz)
00 ('oF')	OFF	13	103.5	26	162.2
01	67.0	14	107.2	27	167.9
02	71.9	15	110.9	28	173.8
03	74.4	16	114.8	29	179.9
04	77.0	17	118.8	30	186.2
05	79.7	18	123.0	31	192.8
06	82.5	19	127.3	32	203.5
07	85.4	20	131.8	33	210.7
08	88.5	21	136.5	34	218.1
09	91.5	22	141.3	35	225.7
10	94.8	23	146.2	36	233.6
11	97.4	24	151.4	37	241.8
12	100.0	25	156.7	38	250.3

NOTE: Channel 05 11 and 35 are not CTCSS programmable.

## Warranty

### ONE YEAR LIMITED WARRANTY

**IMPORTANT:** Evidence of the original purchase is required for warranty service.

**WARRANTOR:** Uniden New Zealand Limited. Uniden Australia Pty Ltd. ACN 001 865 498

**ELEMENTS OF WARRANTY:** Uniden warrants to the original retail owner for the duration of this warranty its UH013 (hereinafter referred to as the Product), to be free from defects in materials and craftsmanship with only the limitations or exclusions set out below.

**WARRANTY DURATION:** This warranty to the original retail owner only is only valid in the original country of purchase and shall be of no further effect 12 months after the date of original retail sale. This warranty will be deemed invalid if the Product is: (A) Damaged or not maintained as reasonable and necessary, (B) Modified, altered or used as part of any conversion kits, subassemblies, or any configurations not sold by Uniden, (C) Improperly installed, (D) Repaired by someone other than an authorised Uniden Repair Agent for a defect or malfunction covered by this warranty, (E) Used in conjunction with any equipment or parts or as a part of a system not manufactured by Uniden. (F) Only available in the original country of sale.

**PARTS COVERED:** This warranty covers for one (1) year, the UH013 tranceiver only. All accessories (Mounting bracket, Microphone etc.) are covered for 90 days only.

**STATEMENT OF REMEDY:** In the event that the Product does not conform to this warranty at any time while this warranty is in effect, the warrantor, at its discretion, will repair the defect or replace the Product and return it to you without charge for parts and service. THIS WARRANTY DOES NOT COVER OR PROVIDE FOR THE REIMBURSEMENT OR PAYMENT OF INCIDENTAL OR CONSEQUENTIAL DAMAGES. THIS GUARANTEE IS IN ADDITION TO AND DOES NOT IN ANY WAY AFFECT YOUR RIGHTS UNDER THE CONSUMER GUARANTEE ACT.

**PROCEDURE FOR OBTAINING PERFORMANCE OF WARRANTY:** in the event that the Product does not conform to this warranty, the Product should be shipped or delivered, freight prepaid, with evidence of original purchase (e.g. a copy of the sales docket) to the warrantor at:

#### UNIDEN AUSTRALIA PTY LIMITED

##### SERVICE DIVISION

345 Princes Highway,  
Rockdale,  
NSW 2216,

AUSTRALIA

Ph: (02) 9599-3100

Fax: (02) 9599-3278

Toll Free: 1300 36 895

[www.uniden.com.au](http://www.uniden.com.au)

#### UNIDEN NEW ZEALAND LIMITED

##### SERVICE DIVISION

150 Harris Road,  
East Tamaki,  
Auckland,

NEW ZEALAND

Ph: (09) 273 8383

Fax: 274 0009

Toll Free: 0800 486 4336

[www.uniden.co.nz](http://www.uniden.co.nz)

# Uniden<sup>®</sup>

©2002 Uniden Australia Pty Limited / Uniden New Zealand Limited  
Printed in the Philippines  
PPC: **UTZZ01887ZZ**

## Free Manuals Download Website

<http://myh66.com>

<http://usermanuals.us>

<http://www.somanuals.com>

<http://www.4manuals.cc>

<http://www.manual-lib.com>

<http://www.404manual.com>

<http://www.luxmanual.com>

<http://aubethermostatmanual.com>

Golf course search by state

<http://golfingnear.com>

Email search by domain

<http://emailbydomain.com>

Auto manuals search

<http://auto.somanuals.com>

TV manuals search

<http://tv.somanuals.com>