

Uniden®

UDR444 WIRELESS VIDEO SURVEILLANCE

Owner's Manual



www.uniden.com

CUSTOMER CARE

At Uniden®, we care about you!

If you need assistance, please do NOT return this product to your place of purchase. Our customer care specialists are available to serve you.

Quickly find answers to your questions by:

1. Reading your owner's manual, included with this product.
2. Visiting our customer support website at www.uniden.com.
3. Calling our customer care specialists at 1-817-858-2900 or 1-800-658-8068.

Uniden surveillance products are not manufactured and/or sold with the intent to be used for illegal purposes. Uniden expects customers' use of these products to be in compliance with all local, state, and federal law. For further information on video surveillance and audio recording legal requirements, please consult your local, state, and federal law.

© 2013. All rights allowed by law are hereby reserved.

IMPORTANT SAFETY PRECAUTIONS

This manual contains important information about this product's operation. If you are installing this product for others, you must leave this manual or a copy with the end user.

When using your equipment, always follow basic safety precautions to reduce the risk of fire, electric shock and injury to persons, including the following:

- The camera is weatherproof and has an IP65 rating.
- To avoid any risk of electric shock from lightning, avoid handling any electronic devices (except battery-powered ones) during an electrical storm.
- Use only the power cord indicated in this manual.
- Never tug or pull on any power cord; be sure to leave some slack in the cord when placing your equipment, and always use the plug to unplug cord from the wall outlet.
- Never leave power cords where they can become crushed, cut, or frayed; when running power cords, avoid letting them rub against any sharp edges or lie across any high traffic areas where people might trip over them.
- Do not use the device if the adapter cords or plugs have been damaged, the monitor has been exposed to liquids, or the monitor/camera has been dropped or is damaged.



WARNING TO PARENTS AND OTHER USERS

Failure to follow these warnings and the assembly instructions could result in serious injury or death. This product is not designed or intended for use as a medical monitor, nor should this product be used as a substitution for medical or parental supervision. Always be sure that both the transmitter and receiver are working properly, and are within range of each other.

- **STRANGULATION HAZARD.** Keep the adapter cords out of the reach of children.
- **WARNING: KEEP OUT OF THE REACH OF CHILDREN.** This product is not a toy and is not intended for use by any children under the age of 13. If you are between the ages of 13 and 18, review these terms, conditions and safety warnings with your parents or guardian to make sure that you and your parent or guardian understand these terms, conditions, and safety warnings.
- Allow for proper ventilation when units are in use. Do not cover the camera or receiver with any object such as a blanket. Do not place it in a drawer or in any location which would muffle the sound or interfere with the normal flow of air.

SAVE THESE INSTRUCTIONS!

FOR BEST RESULTS

To avoid damage to your equipment, follow these simple precautions:

- Do not drop, puncture or disassemble any part of the equipment. There are no user-serviceable parts inside.
- Do not expose the equipment to high temperatures, and avoid leaving the equipment in direct sunlight for more than a few minutes. Heat can damage the case or electrical parts.
- Do not place heavy items on top of the equipment or expose the equipment to heavy pressure.
- Remove the power adapter during long periods between usages.
- Clean only with a dry cloth.

Failure to follow the instructions in this operating manual will void the warranty. Uniden assumes no liability for damages to property or injury to persons caused by improper handling or failure to comply with these safety instructions.

CONTENTS

CUSTOMER CARE.....	2
FOR BEST RESULTS.....	3
OVERVIEW	6
USING THE MANUAL	6
UDR444 FEATURES	6
GETTING STARTED.....	7
WHAT'S INCLUDED	7
INSTALLATION.....	7
General Placement Considerations	7
Installing Your Monitor	8
Installing the Camera.....	8
BASIC OPERATION	11
WIRELESS Monitor.....	11
WIRELESS CAMERA	13
Front & Back Controls.....	13
LCD DISPLAY	14
USING THE UDR444	15
Viewing Modes	15
Common Operations	15
UDR444 SYSTEM MENUS	18
ALERT.....	18
POWER SAVE.....	19
SYSTEM	19
Date & Time.....	20
Brightness.....	20
A/V Out.....	21
Language	21
Format.....	21
Default.....	22
CAMERA.....	22
Pair.....	23
On/Off.....	23
RECORD.....	24
Video Quality	24
Trigger Recording Time	24
Motion Sensitivity	25
Schedule Recording	26
Overwrite	27
SPECIAL FEATURES.....	28
RECORDING VIDEO	28
Manual Recording.....	28
VIEWING RECORDED VIDEO	28

DELETING RECORDED FILES	29
USING THE INTERCOM.....	29
VIEWING LIVE VIDEO	29
Viewing On Your TV	29
Viewing On Your Computer	30
Viewing on Your Wireless Device or Remote Computer	30
PAIRING ACCESSORY CAMERAS	31
MAINTAINING YOUR SYSTEM.....	33
MONITOR.....	33
CAMERAS	33
Troubleshooting.....	34
Specifications.....	35
MONITOR.....	35
General.....	35
Monitor	35
CAMERA.....	36
General.....	36
Camera.....	36
APPENDIX A: HOW TO SET UP YOUR UDR444 FOR REMOTE VIEWING VIA SKYPE™	37
REQUIREMENTS.....	37
PROCEDURES	37
One-Year Limited Warranty.....	43

OVERVIEW

USING THE MANUAL

This manual is set up in eight sections:

- Overview. This general section tells you how to use this manual. It also lists the system's features.
- Getting Started. This section lists the hardware that should have been in your box and how to set it up.
- Basic Operations. This section describes your equipment's function keys in detail. It also provides a list of basic operations in an abbreviated format, referencing screen details in the next section.
- Uniden UDR444 Screen Descriptions. Here you will find detailed descriptions of each screen and how it is used.
- Special Features. This section tells you about the UDR444 special features, such as how to connect your surveillance system to Skype™ and access it from your remote computer or other wired/wireless devices.
- Maintaining Your System. This section provides tips on how to keep your UDR444 hardware clean and in excellent working condition.
- Solving Problems. Troubleshooting tips are located here.
- Specification. This last section contains hardware and software specifications.

***If any items are missing or damaged, contact our Customer Care Line immediately.
Never use damaged products!***

UDR444 FEATURES

- 4.3" LCD monitor with built-in rechargeable Lithium Polymer battery (up to 4.5 hours)
- Up to 500 ft. wireless transmission range
- Up to 40 ft. motion detection/night vision range
- Camera out of range alert
- Record to microSD card (4GB microSD card included but will support up to 32GB)
- Built-in microphones and speakers (cameras and monitor) support Intercom function for two-way audio communication
- IP65 weather-rated VGA resolution cameras (2 included)
- System expandable up to 4 cameras total (additional cameras sold separately)
- Simultaneous Quad view
- Digital zoom, pan, and tilt
- Schedule recording setting
- AV Out to view video on TV
- USB Out for remote Skype™ connection

GETTING STARTED

WHAT'S INCLUDED

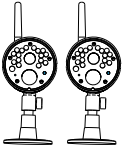

Digital Wireless
Cameras (2)



Digital Wireless
Monitor (1)



Camera Power
Adapters (2)

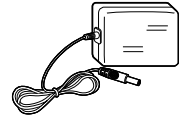

Monitor Power
Adapter (1)

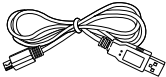

USB Cable

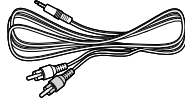

AV Cable

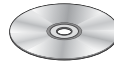

CD

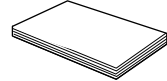

User Manual

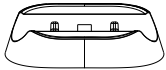

Monitor Cradle



Screws and
anchors
(6 each)

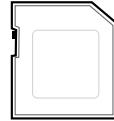

4GB microSD Card
(Adapter not
shown)

***If any items are missing or damaged, contact our Customer Care Line immediately.
Never use damaged products!***

INSTALLATION

General Placement Considerations

The cameras included with your monitor are weatherproof and have an IP65 weather rating. Water can be sprayed on them and they will still work; however, the cameras cannot be submerged underwater.

Although the cameras can be exposed directly to the rain, it is recommended that, if they are used outdoors, they be mounted under some type of cover like a patio overhang or eave. As rainwater drops start to dry on the camera glass, it can create spots that will reflect the light from the infrared LEDs used for night vision, thus causing lower quality video.

Also, as dust, grime, and cobwebs accumulate on the camera glass, they can reflect light from the infrared LED and might lower video quality. Periodically clean the lens glass with a soft cloth.

Consider the following when placing cameras:

- Clear line of sight video transmission distance is up to 500 ft.
 - Walls, especially brick and concrete, shorten the transmission distance.
 - Placement next to windows allows better transmission.
- Avoid having a direct light source in view of the camera. This includes street lights, ceiling or floor lamps, spotlights in the driveway, etc.
- The cameras are equipped with built-in infra-red LEDs so you can use night vision for 24-hour surveillance. The LEDs automatically activate at night and the picture viewed turns to black and white. The night viewing range is up to 40 ft. Avoid pointing the camera lens directly at clear glass; the night vision LEDs will cause a blurred image.
- Optimized motion detection range is up to 40 ft. The farther away an object is, the less accurate the motion detection.
- Avoid pointing the camera directly at any bushes, tree branches, or moving objects that might naturally move due to winds. Otherwise, the motion detection feature may record unnecessarily.
- *Out of Range* displays when the monitor and camera are too far apart. Reposition the equipment.
- A Low Battery icon displays when you need to recharge the battery.

Installing Your Monitor

Out of the box, your monitor has enough power to be used when you place and install the cameras. You can check the camera placement and angle before you physically screw the camera stands into place.

After you have installed the cameras and set up the monitor, plug the AC adapter power output cable into the 5V POWER input of the cradle or monitor. Plug the power plug into a wall outlet or surge protector.

If you are powering the monitor through the cradle, insert the monitor into the cradle at this point. Press firmly to ensure a good connection. The LED on the side panel turns red to indicate charging is in progress. The  icon displays.

Installing the Camera

You can mount the camera with the stand on the bottom (for a flat surface such as a table-top), on the side (for a wall), or on the top (for the ceiling). When you are positioning the camera, you might want to bring the monitor along; it's much easier to get the camera into the right position when you have the monitor handy.

Mount the Camera Base

The following tools are required:

- Electric Drill
- 5mm Drill Bit
- No. 2 Phillips Screwdriver

1. Hold the base of the camera stand where you want to mount it and mark the location of the screw holes.
2. Drill holes using the 5mm drill bit.
3. Insert anchors.
4. Use the included screws to attach the base to the wall or ceiling. You can also screw the base into a flat surface such as a tabletop if needed.

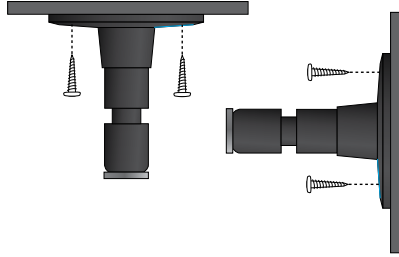

5. Before attaching the camera, tug gently on the stand to make sure it is securely in place.

Attach the camera

1. For each camera, attach the camera bracket to the mounting screw. You can attach the stand to the top or the bottom of the camera as needed. Tighten it a few turns, then turn the camera to face the direction you want.
2. Tighten the camera brace up against the camera to secure it into place.
3. Unlock the mounting post by turning the wingnut to the left a few turns.
4. Set the mounting post to the correct angle, then tighten the wingnut until the post is locked into place.
5. Attach the antenna to the rear of the camera.

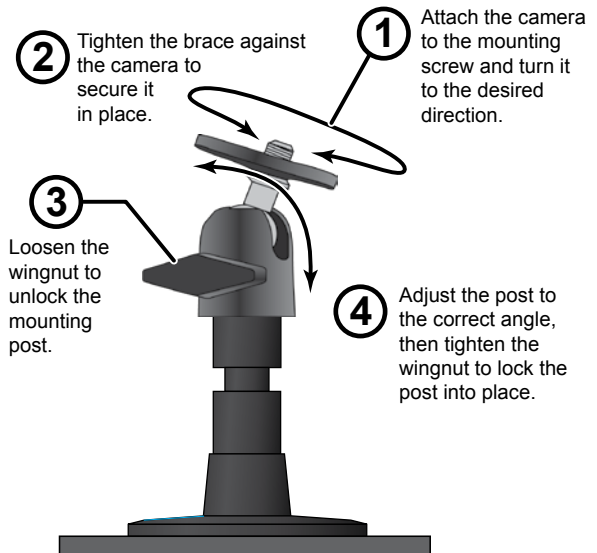

Power Up the Monitor

1. Press and hold the **POWER** button on the left side of the monitor for 1 - 2 seconds to turn it on.

2. The monitor displays the Uniden title screen and then displays the live view.

Power Up the Camera

1. Connect one end of an AC adapter to the camera's power pigtail and plug the other end into a 120 volt AC (standard indoor) power outlet.
2. Cameras provided in the kit are already paired to the monitor. Once they are powered up, the monitor displays images from that camera.
3. Adjust the camera viewing position if needed.

If...	Try this...
there is no camera picture	Verify that the power supply adapter for the camera(s) is plugged in.
the picture quality is poor	Clean the camera lens.
a white image appears at night	The camera's infra-red LED shines invisible light that reflects off surfaces such as glass, causing white light. Place the camera on the other side of windows with the lens flush against the surface to improve the night vision, or place the camera in a well-lit area.

BASIC OPERATION

WIRELESS MONITOR

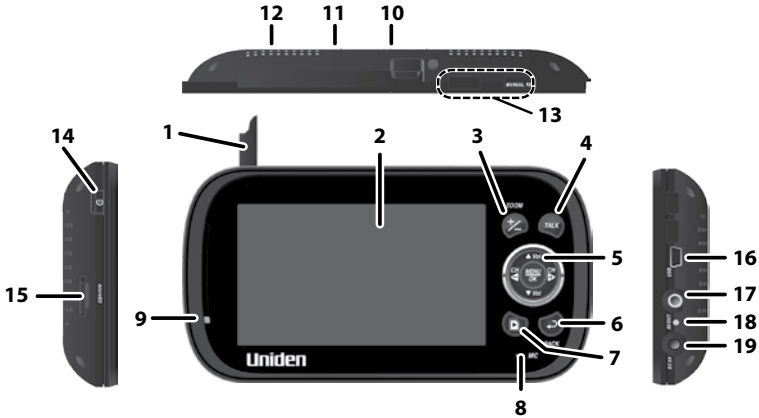

No.	What it does
1	Antenna: Receives signals (video and audio) from cameras.
2	LCD Screen: Displays video from the cameras.
3	Zoom (+/-): Set the image to double size. In Zoom mode, use the navigation buttons to see the parts of the image not displayed on the LCD screen. Return it to original size by selecting Zoom again.
4	Talk: Press and hold while in Live view mode to talk to the camera side.
5	<p>Navigation Controls: Use the controls in Live view, Menu mode, and Playback mode. You can use these controls in Zoom mode as well.</p> <p>▼Vol, ▲Vol</p> <ul style="list-style-type: none"> • Move up or down in Menu mode. • Increase or decrease the volume in Live view. • Play and Pause in Playback mode (▲Vol). • Stop in Playback mode (▼Vol). <p>CH</p> <ul style="list-style-type: none"> • Move left in Menu mode. • Press this button to change viewing camera channel in Live view. • Fast backward in Playback mode.

No.	What it does
	 <ul style="list-style-type: none"> • Move right in Menu mode. • Press this button to change viewing camera channel in Live view. • Fast forward in Playback mode. <p>Menu/OK</p> <ul style="list-style-type: none"> • Press to access the UDR444 menu. • Confirm selections in Menu mode.
6	Back: Press this button to return to previous screen.
7	Video Playback: During live video, press to go to the <i>Recorded File</i> screen.
8	Microphone: For two-way audio to camera.
9	<p>Power On LED</p> <ul style="list-style-type: none"> • On = Battery capacity good • Flashing = Low battery
10	Monitor Stand: Built-in stand for when monitor is not in cradle.
11	Speaker: Output sound received from camera.
12	Reset Button: Insert a blunt thin object (such as an unbent paper clip) into the reset button hole on the back of the monitor screen. This will also turn off the monitor. Press POWER to turn it back on.
13	Manual Rec: Press this button to start Manual Recording mode. Press again to stop recording.
14	Power button: Turns monitor on and off. (Press and hold a few seconds longer to turn monitor off.)
15	microSD: microSD card slot.
16	USB Port: Uses USB cable to connect the monitor to the computer for remote access using Skype™.
17	AV OUT: Uses A/V cable to connect the monitor to the TV to view live video.
18	<p>Charging LED indication:</p> <ul style="list-style-type: none"> • Green = Battery is fully charged. • Orange = Battery is almost charged. • Red = Battery is charging.
19	Power input (DC 5V): Connect the included 5V DC power adaptor to power the monitor and/or charge the monitor battery (when the monitor is not in the cradle).

WIRELESS CAMERA

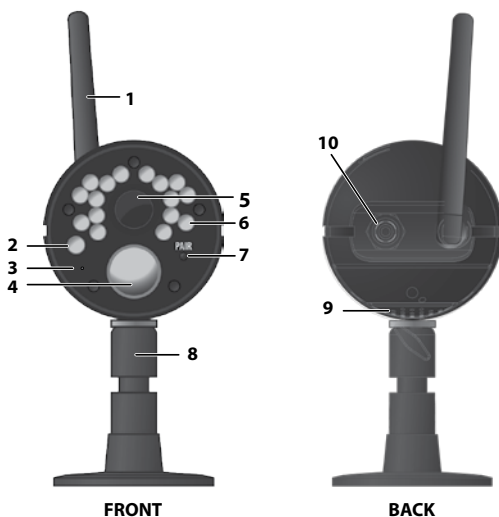

Front & Back Controls

No.	What it does
1	Camera Antenna: Sends signals to the monitor.
2	Light sensor: Measures light intensity to activate IR LEDs for night vision.
3	Microphone: Receives sounds from the area near the camera.
4	PIR sensor: Detects motion within camera's line of sight.
5	Camera Lens: Mechanism through which the cameras view surroundings and record images.
6	Infrared LED: Infrared LEDs provide viewing in no/low light conditions.
7	Pair: Press this button to pair the camera to the monitor.
8	Camera stand: Connects to the camera to allow multiple mounting positions.
9	Speaker: Transmits sound from the monitor (intercom).
10	Power Input (9V DC): Connect to power adapter.

LCD DISPLAY

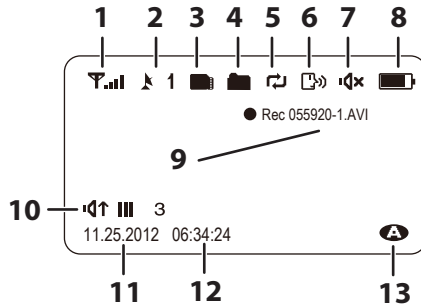

No.	What it does																		
1	<p>Signal Indicator: Shows the camera's signal strength.</p> <table border="1"> <thead> <tr> <th>Signal Strength</th> <th>Indicator</th> <th>Warning</th> </tr> </thead> <tbody> <tr> <td>Perfect</td> <td></td> <td>None</td> </tr> <tr> <td>Good</td> <td></td> <td>None</td> </tr> <tr> <td>Fair</td> <td></td> <td>None</td> </tr> <tr> <td>Low</td> <td></td> <td>None</td> </tr> <tr> <td>No Signal</td> <td></td> <td>Out of Range</td> </tr> </tbody> </table>	Signal Strength	Indicator	Warning	Perfect		None	Good		None	Fair		None	Low		None	No Signal		Out of Range
Signal Strength	Indicator	Warning																	
Perfect		None																	
Good		None																	
Fair		None																	
Low		None																	
No Signal		Out of Range																	
2	<p>Channel indicator: Displays the current channel number. Press or to switch between available cameras.</p>																		
3	<p>MicroSD Card indicator: Displays if there is a microSD card in the slot. <i>A white icon indicates a microSD card has been inserted. A red icon indicates microSD card memory is full.</i></p>																		
4	<p>New Record indicator: Displays and flashes when a new recorded file is available.</p>																		
5	<p>Overwrite indicator: Choose Yes to enable the overwrite function in recording setting. This means the video monitor will overwrite old video files once the card is full.</p>																		
6	<p>Talk Back: Displays when TALK is pressed.</p>																		
7	<p>Mute: Displays when volume is turned off.</p>																		
8	<p>Battery: Indicates the amount of power remaining in the batteries. The icon displays when the battery is charging. The icon flickers when charging is nearly complete.</p>																		

No.	What it does
9	Current Recording Status: Displays when the monitor is recording video. The file name displays in hour/minute/second/recording camera format (055920-1).
10	Volume indicator: This icon displays when you press ▲Vol or ▼Vol . An arrow indicates the last volume adjustment direction and status bars indicate the volume level.
11	Current Date: Displays the date in MMDDYYYY format.
12	Current Time: Display the time in HH:MM:SS format.
13	Auto Recording indicator: Icon appears when the camera's motion detection function has been triggered. The camera records for 15, 30, or 60 seconds, depending on how it is set in the <i>Trigger Recording Time</i> screen. You can also select OFF to disable the function.

USING THE UDR444





Viewing Modes

In Live view, video displays live images from the camera in the following modes:

- Quad mode: Monitor displays video from all cameras on a single screen in 4 quadrants.
- Single mode: Monitor displays video from one camera at a time.
- Scan mode: Monitor displays video from one camera at a time, but cycles through all cameras one by one.

Common Operations

To...	Do This...
Change between quad view, single view, and scan for Live view	From Quad view, press  to cycle the screens in the following order: Scan - CH1 - CH2 - CH3 - CH4 - Quad
Manually start recording	Press MANUAL REC on top of the monitor (see page 28).
Set up to record automatically	Refer to <i>Schedule Recording</i> from the <i>Record</i> menu (see page 26).
Manually stop/cancel recording in Manual, Motion, or Schedule Record mode	Press MANUAL REC on top of the monitor (see page 28).

To...	Do This...
Manually cancel a Scheduled Record	<ol style="list-style-type: none"> 1. Select <i>Record/Schedule Record</i>. 2. Select the specific day whose recording schedule you want to cancel. 3. When that day's schedule displays, use  or  buttons to turn that day's schedule to <i>Off</i> (see page 26).
Playing back a recording on the UDR444 monitor	Press  . The <i>Play File</i> screen displays. See page 28 for details.
Cancel watching a recorded video	Press  .
Watching recorded video on PC or television	<p>To view on PC: Place the UDR444's microSD card in the PC's memory slot (microSD card adapter included). You can play the files from the card itself or copy the files to your computer and play them from that destination.</p> <p>To view on TV: Use the AV cable to connect the monitor to the TV. Use the monitor's control buttons to access the recorded video on your system's microSD card.</p>
Set the date and time	See <i>System/Date&Time</i> , page 20.
Transfer a recording from the monitor's SD card to the computer.	<ol style="list-style-type: none"> 1. Remove the memory card from the monitor and insert it in an adapter. 2. Insert the SD adapter into your PC. 3. Select a destination to store the files.
Watch live video on your smartphone	<ol style="list-style-type: none"> 1. Be sure both your home computer and smartphone/device have Skype™ accounts. 2. Set up your home computer to view live video. 3. Use Skype™ on your smartphone/device to call your home computer. 4. When you are connected, you will see live video. (See page 30 for details.)
Adjust UDR444 volume	<ol style="list-style-type: none"> 1. Press ▲Vol (increase volume) or ▼Vol (decrease volume) when viewing a camera. 2. The  icon displays, then turns off after 5 seconds of inactivity.



To...	Do This...
How do you use the Intercom?	<ol style="list-style-type: none"><li data-bbox="456 105 751 129">1. Press and hold TALK.<li data-bbox="456 150 770 173">2. Release to hear reply.
How do you delete individual recorded files?	Select the red X next to the file name on the <i>PLAY FILE</i> screen. See page 28 for details.

UDR444 SYSTEM MENU

Press  to access the UDR444 system menu options. Use the navigating buttons to navigate up/down/left/right in the menu, and press **MENU/OK** to confirm a setting.

The Main menu options are:

- Alert
- Power Save
- System
- Camera
- Record

1. Press  or  to change options. The icon for the selected option enlarges.





2. Press **MENU/OK** to select that option.

ALERT

This option allows you to set the alert volume for the unit. There are 6 levels plus off. [Default = Off (mute)].



Press  or  to increase or decrease the alert volume.

POWER SAVE

This option allows you to enable/disable the Power Save function. Enable this function to turn off the LCD backlight after 2 minutes of inactivity. The monitor "wakes up" if it detects motion or if you press any key. (Default = Off)



SYSTEM

These system setup options allow you to configure your system according to your personal preferences. Use the directional arrows to select one of the six options:

- Date&Time
- Brightness
- A/V out
- Language
- Format
- Default



Date & Time



The Month option is automatically selected when you select *Date & Time*.

1. Press ▲ **Vol** or ▼ **Vol** to scroll through the options for that selection.
2. Press **CH** or **CH** to switch to another section of the date or time. Press ▲ **Vol** or ▼ **Vol** to scroll through the options as before.
3. Press **MENU/OK** to save the current setting and return to the *System* screen.

Time displays in "Military" time (i.e., 00-24 hours). For example, 14:30 would be 2:30 PM.

Brightness

This option allows you to change the LCD brightness. There are 6 brightness levels. (Default = 3)



1. Press **CH** or **CH** to increase/decrease the brightness level (0 - 6).
2. Press **MENU/OK** to save and return to the *System* screen.

A/V Out

This option allows you to select the TV output format. (Default = NTSC)

NTSC is the TV standard in North America.



1. Press **▲ Vol** or **▼ Vol** to select either *NTSC* or *PAL* for this option.
2. Press **MENU/OK**; the *System* screen displays.

Language

This option allows you to select the display language for the system. (Default = English)



1. Press **▲ Vol** or **▼ Vol** to select a language.
2. Press **MENU/OK** after you make your selection. The *System* screen displays.

Format

This option allows you to format the external storage (microSD) card, deleting all files on that card. (Default = No)

Be careful when using this feature. All files on the microSD card will be erased.



1. Insert a microSD card into the monitor if needed.
2. Select Yes, then press **MENU/OK**.
3. *FORMAT* displays; once formatting is complete, the *System* screen displays.

If you try to format the microSD card but no microSD card is inserted, NO SD CARD displays.

Default

This option allows you to restore the UDR444 to factory settings. (Default = No)

Camera pairings and date/time settings are not affected by a reset.

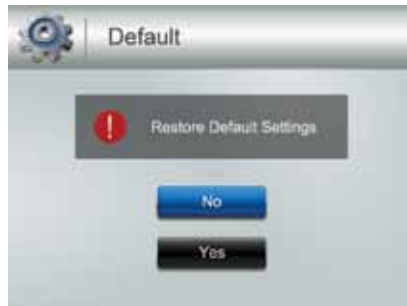

1. Press **▲Vol** or **▼Vol** to select either *No* or *Yes* for this option.
2. Press **MENU/OK** after you make your selection. The *System* screen displays.

CAMERA

This options allows you to pair the monitor with up to 4 cameras or turn on/off individual channels (cameras). Press **▲Vol** or **▼Vol** to select *Pair* or *On/Off* for this option.

The two cameras that come with your system are paired to the monitor at the factory.



Pair

Select this option if you are pairing accessory cameras or changing a camera's channel assignment.

1. Press **▲Vol** or **▼Vol** to select the camera you want to pair to the monitor.





2. Press **MENU/OK**.
3. An information message displays, indicating that you have 30 seconds to press the pairing button on the front of the camera.
4. The camera video displays when that camera has paired.

On/Off

This option allows you to turn an individual channel on or off. The camera will remain powered on but the monitor will no longer receive video and audio.



1. Press **▲Vol** or **▼Vol** to select the channel whose status you want to change.

2. Press **CH**  or **CH**  to change the setting (*On* or *Off*).
3. Press **MENU/OK** to confirm the setting. The main *Camera* screen displays.

RECORD

The *Record* screen contains 5 sub-screens that help you establish the quality level of your recordings and a repeatable one week recording schedule.

- Video Quality
- Trigger Recording Time
- Motion Sensitivity
- Schedule Recording
- Overwrite



Video Quality

This option allows you to preset the output video quality for the unit. (Default = Low 320 × 240)



1. Press **▲Vol** or **▼Vol** to choose between higher quality (*High 640x480*) and lower quality (*Low 320x240*) video output.
2. Press **MENU/OK**. The *Record* screen displays.

Trigger Recording Time

Various things can alert the system to begin recording. These triggers range from the wind blowing a tree branch into an outside camera's line of sight to someone walking into a room. This option lets you set how long the system will record once it has been triggered. (Default = 30 s)



1. Press ▲Vol or ▼Vol to select the recording time.
2. Press MENU/OK.

If you select Off, the system won't start to record, even if a trigger occurs and motion detection is enabled.

If you select a recording duration (15, 30, or 60 seconds),  displays during recording.

3. The Record screen displays.

Motion Sensitivity

This option allows you to set the motion sensitivity for each channel individually. For example, if Camera 1 is an outside camera, you could set the sensitivity lower. This could keep the cameras from triggering over small movements, such as the breeze moving a tree branch. (Default = Low)

1. Press ▲Vol or ▼Vol to select the channel whose sensitivity you want to adjust and press MENU/OK.



- The camera's sensitivity levels display on the next screen. Select the sensitivity level and press **MENU/OK**.



- The *Motion Sensitivity* screen displays again.

Schedule Recording

This option allows you to create a weekly recording schedule. This weekly schedule repeats until you change it. You can set each day separately, and you can also set that day's schedule to turn on or off. For example, if you have camera 1 set to record your back yard every evening from 20:00 hours (8:00 PM) until 23:00 hours (11:00 PM) but you will be having a party in the back yard that evening, you can turn off that day's scheduled recording. (Default = Monday / Start Recording Time:00:00 / End Recording Time: 00:00 / Off)

- From the *Record* screen, select *Schedule Recording* and press **MENU/OK**. The *Schedule Recording* screen displays. Select a day and press **MENU/OK**. The start and end time setting screen for that day displays.



- Using **▲Vol** or **▼Vol**, scroll to set the recording start and end times. Press **CH** after each selection to move to the next. For example, set Start Recording Time - Hours, then press **CH** to move to Start Record Time - Minutes.
- After you set *End Recording Time* and press **▶**; set the recording schedule for that day on or off. Use the directional arrows (**CH** or **CH**) to select *On* or *Off*.
- Press **MENU/OK** to set your selection. The *Schedule Recording* screen displays.

Overwrite

When the microSD card is full, the new video recording overwrites the oldest video recording. Select *Yes* to enable this function. (Default = No)



SPECIAL FEATURES

RECORDING VIDEO

Video records on the 4GB microSD card included in your package (the UDR444 will support up to a 32GB microSD card). You can set up a recording schedule so the UDR444 records automatically (see page 26), or you can manually start recording.



When the UDR444 records (motion, schedule, manual, etc), all buttons are disabled except MANUAL REC. The system responds normally after recording has ended. To stop recording and continue with normal operations, press MANUAL REC.

Manual Recording



Be sure a microSD card is inserted into the microSD card slot.

1. Press **Manual Rec** on the top of the monitor. The monitor records in 10 minute blocks.
2. Press **Manual Rec** again to cancel manual recording.

In Recording mode, only the TALK button and sound are active.

When there is new recorded file,  (yellow) flashes on the LCD screen. When the microSD card is full,  (red) flashes.





VIEWING RECORDED VIDEO

1. Press  to enter the *PLAY FILE* list.
2. Select the Video folder and press .
3. That folder contains other folders sorted by date (Format = MMDDYYYY). For example: 03302012 means the videos in this folder are recorded on March 30th, 2012. Press **▲Vol** or **▼Vol** to select a folder you want to view and press **MENU/OK** to open that folder and browse the files inside.

If there are multiple pages of folders, press  to move to the next page. Press  to return to the previous page.



4. Inside that folder are record files, sorted by time. For example: 123030_1 means the video is recorded at 12:30:30 and from camera 1.



5. Select the video you want to view and press **MENU/OK**. The video plays on the LCD screen.
6. Use the navigation buttons to manage the video:
 - **▲ Vol** - Pause, play video
 - **▼ Vol** - Stop
 -  - Forward (up to x16 speed)
 -  - Backward (up to x16 speed)
 -  - Exit the video
 -  - After you exit the video, exits Playback function



DELETING RECORDED FILES

You can delete a specific recorded videofile or an entire folder of files. A red "X" displays to the right of folders and recorded video files on the *PLAY FILE* screen.

1. Press  to highlight the red "X" beside the folder or file you want to delete. Press **MENU/OK**.
2. A confirmation screen displays. Use  or  to select Yes. Press **MENU/OK**.

USING THE INTERCOM

The Intercom feature lets you talk to whomever is within camera range.

1. Make the camera you want to establish an intercom link with the full screen live view camera.
2. Press and hold  on the monitor.
3. Speak clearly into the microphone.
4. Release  to listen to the response.

VIEWING LIVE VIDEO

The Uniden UDR444 let you view live video from your system on your television. You can also use Skype™ to view your system on a remote PC or wireless devices such as an iPhone®, iPad®, or Android™ smartphone or tablet.

Viewing On Your TV

1. Connect the monitor to your television using the AV Output cable (included).
2. The monitor screen goes blank and the TV screen displays the camera output.

The monitor controls still operate while the system is connected to the TV. You can change cameras, set the cameras to scan through each in sequence, etc.

Viewing On Your Computer

1. Insert the CD included in your package into your PC. Select the USB Driver file and double-click to run the program.
2. Follow the instructions from the InstallWizard. Select *Finish* to complete the installation. *Found New Hardware* displays.
3. Connect your home computer to the monitor with the USB cable (included). The monitor screen will go blank. Your UDR444 system is now connected to your home PC.

Viewing on Your Wireless Device or Remote Computer

Setup

1. Follow the procedures to view live video on your computer, above.
2. Set up a Skype™ account linked to your UDR444. Please refer to www.skype.com for details on setting up this free account.

Be sure the Skype™ account is set to "Auto Answer."

3. Set up a Skype™ account on your wireless device or remote computer.
4. Invite the other Skype™ account into your contacts; accept the invitation from the invited account.

Viewing

1. Determine which camera you want to be available for remote viewing. Set it as the Live view camera (see page 15).
2. If you have not already installed the USB driver, install it now (see page 28).
3. Connect the UDR444 to your home computer using the USB cable.
4. Activate Skype™.
5. From your wireless device or remote computer, call the Skype™ account for the UDR444. Because that account was set up with Auto Answer, you should see live video from the camera you set up in Step 1.

You must have a separate Skype™ account to call the home computer. You cannot use your home computer's Skype™ account to call itself.

VIEWING RECORDED VIDEO ON YOUR COMPUTER

The files that record on the UDR444 record onto the microSD card in AVI format. You can take that card and play it on your computer. You will need:

- UDR444 microSD card
- MicroSD card adapter for laptop (included) or SD card reader for other systems (not included)

1. Remove microSD card from the UDR444. Place it in the adapter and insert adapter into your PC.
2. Navigate to the SD card on your system.
3. Select the files you want to view and click *Open*.
4. The files begin playing, in order, through your default media player.

PAIRING ACCESSORY CAMERAS

The two cameras that come with your UDR444 are paired to your monitor at the factory. If you add cameras, install them and then pair the camera to the monitor.

1. Press **MENU/OK** to bring up the *System* screen.
2. Select the Camera option.



3. Select *Pair* and then press **MENU/OK**. The *Pair* screen displays. The pairing function assigns each camera to a different channel on the wireless monitor (up to 4 cameras), and is necessary for configuring additional cameras.



4. Select the channel you want to pair the camera to and press **MENU/OK**. The *Press Pair Key* message screen displays.
5. Within 30 seconds, press **PAIR** on the camera's face. Once the camera pairs to the monitor, it will be immediately viewable on the monitor.

MAINTAINING YOUR SYSTEM

MONITOR

As you use your monitor, keep the screen clean by wiping it with a microfiber cloth to remove fingerprints, dust, etc.

CAMERAS

When dust and grime builds up on the camera lens and glass, it affects night vision capability. The infrared light reflects off of the dust and grime, limiting the camera's "vision." Use a microfiber cloth to regularly clean the cameras or when night vision video is cloudy or unclear.

TROUBLESHOOTING

If you have problems with the system, there is often a quick and simple solution. Please try the following:

Problem	Solution
No picture	<ul style="list-style-type: none">• Check all camera connections.• Verify that the AC adapter is plugged in.• Make sure the monitor is ON.• Make sure the camera is in range.
The picture keeps dropping	<ul style="list-style-type: none">• Move the camera closer to the monitor.• Reposition the camera , monitor, or both to improve reception.
No sound	<ul style="list-style-type: none">• Increase the volume.• Make sure there is sound within range of the camera's microphones.
Loud, screeching noises (Audio feedback)	Move the camera and the monitor farther apart.
The picture is choppy	<ul style="list-style-type: none">• Move the camera and monitor closer to each other.• Remove any obstructions between the camera and monitor.
The picture appears grainy (using AV Out to view on TV/Monitor)	<ul style="list-style-type: none">• View files on a smaller TV/PC monitor.• Try viewing through your TV's Picture-In-Picture function, if available.
Recording problems	<ul style="list-style-type: none">• Make sure the microSD card is inserted correctly.• Check that the microSD card memory is not full.• Verify that the microSD card is compatible with the UDR444. It can support up to 32GB microSD card.
The monitor picture has frozen	Use a blunt object like an unbent paper clip to press RESET and reset the monitor screen. This will also turn off the monitor. Press POWER to turn it back on.

SPECIFICATIONS

MONITOR

General

Operating frequency range	2.400 ~ 2.4835GHz
RX sensitivity	- 81dBm
Spread spectrum	FHSS
Modulation type	GFSK
Data Rate	2 Mbps
Communication range	500 ft Line of Sight

Monitor

Display size/type	4.3" TFT LCD
Resolution	H: 480; V: 272
Power requirement	5.0V DC \pm 5%
Power consumption	350mA (Normal) 900mA (Charging)
Operating temperature range	- 10 ~ 40° C
Operating humidity range	Within 85% RH
RoHS Compliance	Yes
Battery life	4.5 hours
Private ID for connection	Yes
Recording storage	4GB microSD card (included). Supports up to 32GB.
Housing material	Plastic

CAMERA

General

Operating frequency range	2.400 ~ 2.4835GHz
TX power	15dBm (typical)
Spread spectrum	FHSS
Modulation type	GFSK
Data Rate	2 Mbps
Communication range	500 ft Line of Sight

Camera

Image sensor type (Manufacturer/Model #)	1/4" color CMOS image sensor (OV7725)
Effective pixel	H: 640; V: 480
Image processing	MJPEG
Image resolution	640x480 @ 10fps 320x240 @ 20fps
Lens	3.6mm F2.0
Exposure	Auto
White balance	Auto
Power requirement	9.0Vdc \pm 5%
Power consumption	160mA (IR LED Off) 350mA (IR LED On)
Operating temp range	-10 ~ 50° C
Weatherproof	IP65
RoHS Compliance	Yes
Camera Housing Material	Plastic

Recycling and Disposal Information

- Do not dispose of electronic devices or any of their components (especially batteries and LCD displays) in your municipal trash collection.
- Consult your local waste management authority or a recycling organization like Earth911.com to find an electronics recycling facility in your area.
- If you are unable to locate proper recycling facilities in your area, please return this product to Uniden for recycling.

APPENDIX A: HOW TO SET UP YOUR UDR444 FOR REMOTE VIEWING VIA SKYPE™

REQUIREMENTS

- Two Skype™ accounts
- A PC computer
- A second computer OR separate Skype™-ready device (i.e. Android or iPhone/tablet)
- Uniden Model UDR444, Wireless Video Surveillance Camera

PROCEDURES

1. Follow the owner's manual instructions for viewing video on your computer (see page 30). Insert the CD included in your package into your PC. Select the USB Driver file and double-click to run the program.



2. Follow the instructions from the InstallShield Wizard. Select *Finish*, completing the installation.

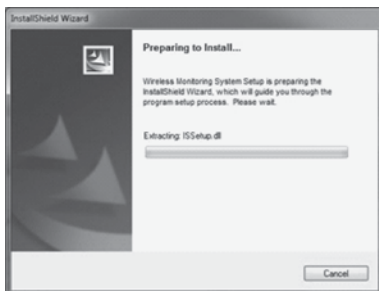

3. Connect your home computer to the monitor with the USB cable (included). The monitor screen goes blank. Your UDR444 system is now connected to your PC.

4. Setup a NEW Skype™ account specifically for your UDR444. DO NOT USE AN EXISTING ACCOUNT. A second personal Skype account is required to view camera video. (Simplified instructions can be found on page 30 of the owner's manual).

Go to www.skype.com and click on **JOIN US** in the top right corner.



Fill out the profile information requested by Skype™ and click *I agree – Continue* at the bottom of the page. *Skype Name* is the name you create for your UDR444 system.

The image shows the Skype account creation form. At the top, there is a dropdown menu labeled 'Select'. Below that is the 'Skype Name*' field with a character count indicator '(1)'. A note below reads: 'Note: only choose a name you have a right to use.' The 'Password*' and 'Repeat password*' fields are next. A note below these fields says: 'Between 6-20 characters, include Latin letters and numbers. Note: no-one else can see your password.' There is a section for 'Inform me about new products, features, and special offers...' with two options: 'By SMS' (unchecked) and 'By email' (checked). Below this is a CAPTCHA image showing the word 'iron' and 'an' with a 'Can't read the text in the box?' link and 'Refresh', 'Listen', and 'Help' buttons. The CAPTCHA text is 'iron an les to'. Below the CAPTCHA is the text 'Type the text above here*' and an empty input field. At the bottom, there is a checkbox for 'Yes, I have read and I accept the Skype Terms of Use and the Skype Privacy Statement'. A large arrow points to the 'I agree - Continue' button at the bottom left.

If you have a Windows 8 machines, you must download Skype for Windows desktop. The native Skype app is not compatible.

Select Download a different version and then select Skype for Windows desktop.

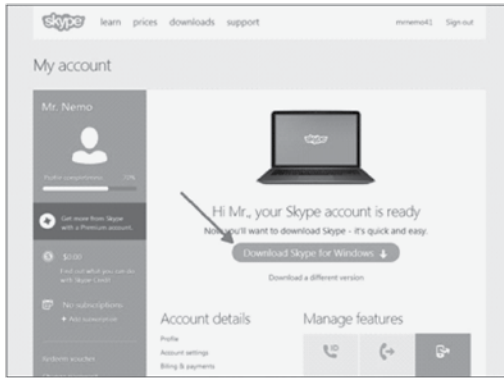

Install Skype™ using the Install Wizard.

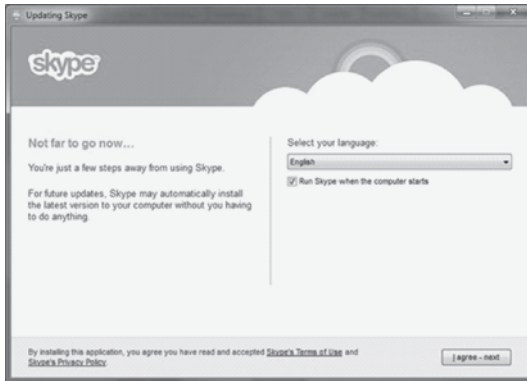

Once installed and logged in, Skype™ should have setup the camera automatically (as long as the camera was still plugged into your computer as mentioned in Step 3 on page 36). If your computer already has a web cam setup or you don't see video from your UDR444, you will have to go into *Tools/Options/Video settings* to select the correct camera.

Click the *Tools* menu and select *Options*.

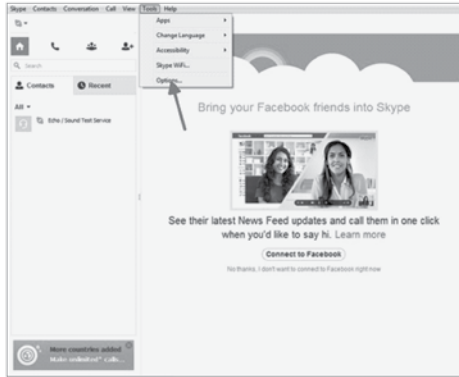

Select *Video settings* and then select *Wireless Monitoring System* in the **SELECT WEBCAM** dropdown box.

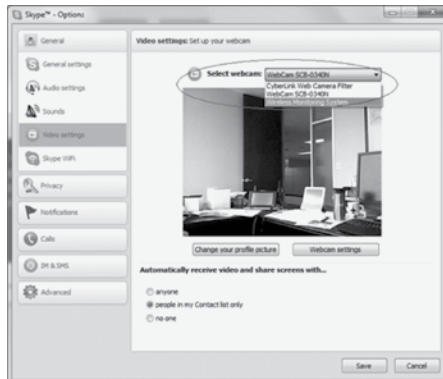

Next, you will need to set Skype™ to answer automatically under certain circumstances. In the *Call settings* screen, select **ANSWER INCOMING CALLS AUTOMATICALLY** and **START MY VIDEO AUTOMATICALLY WHEN I AM IN A CALL** options.

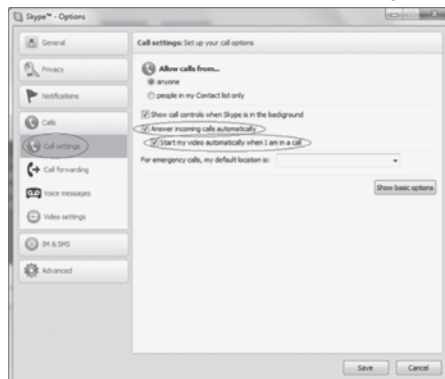

5. Invite your second Skype™ account into your contacts by clicking the **ADD CONTACT** button.

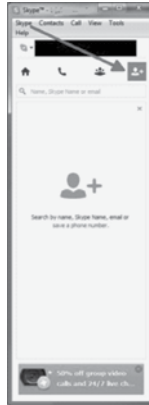

6. On another device, log into the second Skype™ account and accept the invitation.

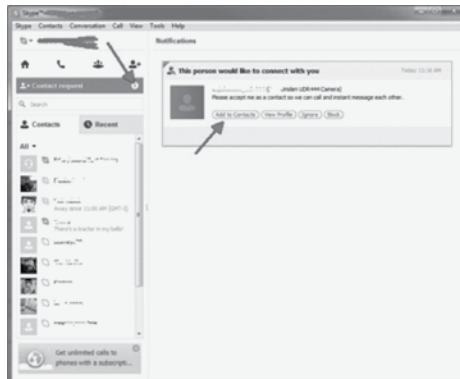

7. If you do not have a second Skype™ account, you will have to create one by following the previous instructions in this Appendix (beginning on page 37).
8. From your second Skype™ account on a different device, call your first Skype™ account that you just added to your contacts list.

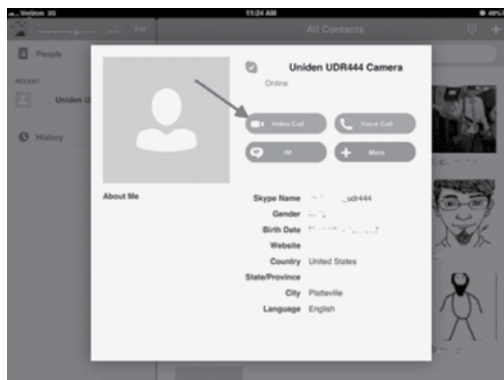

FCC Compliance Information

Part 15 Compliance Statement

This device complies with Part 15 of the FCC Rules. Operation is subjected to the following two conditions: (1) this device may not cause harmful interference, and (2) this device must accept any interference received, including interference that may cause undesired operation.

This equipment has been tested and found to comply with limits for a Class B digital device, pursuant to Part 15 of the FCC rules and ETSI (EN) 300328. These limits are designed to provide reasonable protection against harmful interference in residential installations. This equipment generates, uses, and can radiate radio frequency energy, and if not installed and used in accordance with the instructions, may cause harmful interference to radio communications.

However, there is no guarantee that interference will not occur in a particular installation. If this equipment does cause interference to radio or television equipment reception, which can be determined by turning the equipment off and on, the user is encouraged to try to correct the interference by one or more of the following measures:

- Reorient or relocate the receiving antenna.
- Move the equipment away from the monitor.
- Plug the equipment into an outlet on a circuit different from that to which the monitor is connected.
- Consult the dealer or an experienced radio/television technician for additional suggestions.

CAUTION! Any changes or modifications to this equipment not expressly approved by the party responsible for compliance could void your authority to operate the equipment.

RF Exposure Information

The antenna used for this transmitter must be installed to provide a separation distance of at least 20 cm (7.9") from all persons and must not be collocated or operating in conjunction with any other antenna or transmitter.

IC Compliance Information

Radio Equipment Notice

The term "IC:" before the radio certification number only signifies that Industry Canada technical specifications were met. Operation is subject to the following two conditions: (1) this device may not cause interference, and (2) this device must accept any interference, including interference that may cause undesired

operation of the device. "Privacy of communications may not be ensured when using this device."

CE Compliance Information

Products with CE Marking comply with EMC Directive (2004/108/EC); Low Voltage Directive (73/23/EEC); R&TTE(1999/5/EC) issued by the Commission of the European Community. Compliance with these directives implies conformity to the following European Norms:

- EMC: EN 301 489
- LVD: EN 60950
- Radio: EN 300 328

One-Year Limited Warranty

Important: Evidence of original purchase is required for warranty service.

WARRANTOR: UNIDEN AMERICA CORPORATION ("Uniden") **ELEMENTS OF WARRANTY:** Uniden warrants, for one year, to the original retail owner, this Uniden Product to be free from defects in materials & craftsmanship with only the limitations or exclusions set out below.

WARRANTY DURATION: This warranty to the original user shall terminate & be of no further effect 12 months after the date of original retail sale. The warranty is invalid if the Product is (A) damaged or not maintained as reasonable or necessary, (B) modified, altered, or used as part of any conversion kits, subassemblies, or any configurations not sold by Uniden, (C) improperly installed, (D) serviced or repaired by someone other than an authorized Uniden service center for a defect or malfunction covered by this warranty, (E) used in any conjunction with equipment or parts or as part of any system not manufactured by Uniden, or (F) installed or programmed by anyone other than as detailed by the owner's manual for this product.

STATEMENT OF REMEDY: In the event that the product does not conform to this warranty at any time while this warranty is in effect, warrantor will either, at its option, repair or replace the defective unit & return it to you without charge for parts, service, or any other cost (except shipping & handling) incurred by warrantor or its representatives in connection with the performance of this warranty. Warrantor, at its option, may replace the unit with a new or refurbished unit.

THE LIMITED WARRANTY SET FORTH ABOVE IS THE SOLE & ENTIRE WARRANTY PERTAINING TO THE PRODUCT & IS IN LIEU OF & EXCLUDES ALL OTHER WARRANTIES OF ANY NATURE WHATSOEVER, WHETHER EXPRESS, IMPLIED OR ARISING BY OPERATION OF LAW, INCLUDING, BUT NOT LIMITED TO ANY IMPLIED

WARRANTIES OF MERCHANTABILITY OR FITNESS FOR A PARTICULAR PURPOSE. THIS WARRANTY DOES NOT COVER OR PROVIDE FOR THE REIMBURSEMENT OR PAYMENT OF INCIDENTAL OR CONSEQUENTIAL DAMAGES. Some states do not allow this exclusion or limitation of incidental or consequential damages so the above limitation or exclusion may not apply to you.

LEGAL REMEDIES: This warranty gives you specific legal rights, & you may also have other rights which vary from state to state. This warranty is void outside the United States of America & Canada.

PROCEDURE FOR OBTAINING PERFORMANCE OF WARRANTY: If, after following the instructions in the owner's manual you are certain that the Product is defective, pack the Product carefully (preferably in its original packaging). Disconnect the battery from the Product & separately secure the battery in its own separate packaging within the shipping carton. The Product should include all parts & accessories originally packaged with the Product. Include evidence of original purchase & a note describing the defect that has caused you to return it. The Product should be shipped freight prepaid, by traceable means, to warrantor at:

Uniden America Service

743 Henrietta Creek Rd.

Roanoke, TX 76262

(800) 297-1023, 8 a.m. to 5 p.m., Central, Monday through Friday

Free Manuals Download Website

<http://myh66.com>

<http://usermanuals.us>

<http://www.somanuals.com>

<http://www.4manuals.cc>

<http://www.manual-lib.com>

<http://www.404manual.com>

<http://www.luxmanual.com>

<http://aubethermostatmanual.com>

Golf course search by state

<http://golfingnear.com>

Email search by domain

<http://emailbydomain.com>

Auto manuals search

<http://auto.somanuals.com>

TV manuals search

<http://tv.somanuals.com>