Important Safety Instructions

When using your telephone equipment, basic safety precautions should always be followed to reduce the risk of fire, electrical shock, and injury to persons, including the following:

1. Read and understand all instructions.
2. Follow all warnings and instructions marked on the product.
3. Unplug this product from the wall outlet before cleaning. Do not use liquid cleaners or aerosol cleaners. Use a dry cloth for cleaning.
4. Do not use this product near water; for example, near a sink or in a wet area.
5. Do not place this product on an unstable cart, stand, or table. The telephone may fall, causing serious damage to the unit.
6. To protect the product from overheating, do not block or cover any slots or openings in the Base Unit. This product should never be placed near or over a radiator or heat register. This product should not be placed in a built-in installation unless proper ventilation is provided.
7. This product should be operated only from the type of power source indicated on the marking label.
8. Do not allow anything to rest on the power cord. Do not locate this product where the cord will be damaged by persons walking on it.
9. Do not overload wall outlets and extension cords, as this can result in the risk of fire or electrical shock.
10. Never push objects of any kind into this product through the Base Unit slots, as they may touch dangerous voltage points or short out parts that could result in a risk of fire or electric shock. Never spill liquid of any kind on the product.
11. To reduce the risk of electric shock, do not disassemble this product. Contact qualified service personnel when some service or repair work is required. Opening or removing covers may expose you to dangerous voltages or other risks. Incorrect reassembly can cause electric shock when the appliance is subsequently used.

12. Unplug this product from the wall outlet and refer servicing to qualified service personnel under the following conditions:
 - A. When the power supply cord is damaged or frayed.
 - B. If liquid has been spilled into the product.
 - C. If the product has been exposed to rain or water.
 - D. If the product does not operate normally when following the operating instructions. Adjust only those controls that are covered by the operating instructions. Improper adjustment of other controls may result in damage and will often require extensive work by a qualified technician to restore the product to normal operation.
 - E. If the product has been dropped or the cabinet has been damaged.
 - F. If the product exhibits a distinct change in performance.
13. Do not use the telephone to report a gas leak in the vicinity of the leak.

CAUTION

To reduce the risk of fire or injury to persons by the battery, read and follow these instructions:

1. Use only the appropriate type and size Battery Pack specified in this Operating Guide.
2. Do not dispose of the Battery Pack in a fire. The cell may explode. Check the Lead Acid Battery Disposal information at the beginning of this Guide for disposal instructions.
3. Do not open or mutilate the Battery Pack. Released electrolyte is corrosive and may cause damage to the eyes or skin. It may be toxic if swallowed.
4. Exercise care in handling the battery in order not to short out the battery with conducting materials such as rings, bracelets, and keys. The battery or conductor may overheat and cause burns.
5. Charge the Battery Pack provided with or identified for use with this product only in accordance with the instructions and limitations specified in the instruction manual provided for this product.
6. Observe proper polarity orientation between the Battery Pack and battery charger.

SAVE THESE INSTRUCTIONS

Introduction

About the EXP900

The EXP900 is a 900 MHz Cordless Phone with voice scramble. It is designed and engineered to exacting standards for reliability, long life, and outstanding performance.

Features

- 900 MHz operation
- Redial and Flash
- 10-Number Memory
- AutoStandby
- Battery Saving Feature
- Handset Volume Control/
Ringer Volume Control
- Wall mountable
- Hearing aid compatible
- Belt clip
- Reversible Handset
Retainer
- Tone/Pulse Dialing
- One-Way Page, Base Unit
to Handset
- AutoTalk
- 40 Channels
- Voice Scramble
- Headset Jack for hands
free convenience
- Any Key Answer
- Extended range and clarity
- Visual LED indications
- Automatic Digital Code
Security

The EXP900 features include *AutoTalk™* and *AutoStandby™*. *AutoTalk™* allows you to answer a call by just removing the Handset from the Base so you don't have to waste time pushing buttons or flipping switches. *AutoStandby™* allows you to hang up by simply returning the Handset to the Base.

The *UltraClear Plus* true compander circuitry virtually eliminates background noise. This innovative technology, together with 40 different channels, provides you with the best possible reception during all your conversations.

The EXP900 phone protects your privacy by scrambling any call you make or receive. The RF signal between the Handset and Base Unit are changed, making it difficult or impossible for someone to receive and understand your phone calls.

To protect you against misbilled calls which might result from your phone being activated by other equipment, the EXP900 has *Random Code™* digital security which automatically selects one of over 65,000 digital security codes for the Handset and Base Unit. Also, the *AutoSecure™* feature electronically locks your phone when the Handset is in the Base. To get the most from your EXP900, **please read this Operating Guide thoroughly.**

What's Included with Your EXP900

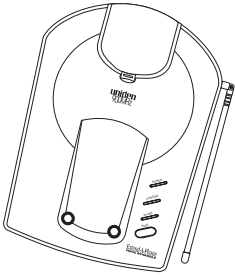

EXP900 Base

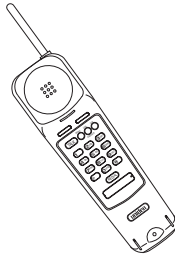

EXP900 Handset

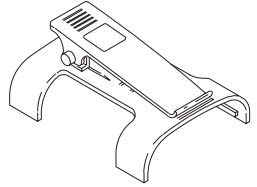

Belt Clip

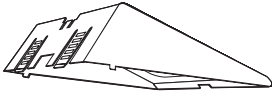

Base Stand

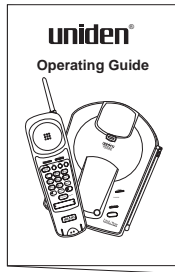

Operating Guide

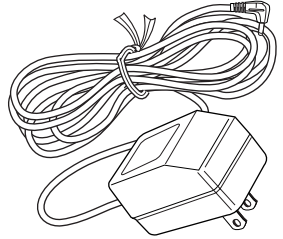

AC Power Adapter



Lead-Acid Battery

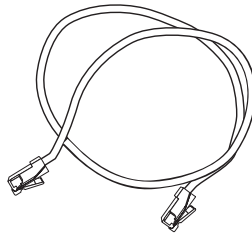

Short and Long
Telephone Cords

If any of these items are missing or damaged, contact your place of purchase.

Installation

Installing Your EXP900

Selecting the Installation Location

Select a location for the EXP900 to avoid excessive heat or humidity (as in a kitchen or bathroom). The Base Unit of your EXP900 can be placed on a desk or tabletop near a standard 120V AC outlet and telephone line jack, mounted on a standard AT&T or GTE wall plate, or mounted directly on the wall. Keep the Base Unit and Handset away from sources of electrical noise (motors, fluorescent lighting, etc.). Be sure there is sufficient space to safely extend the Base Unit antenna fully.

Connecting the Telephone Line

There are three types of phone outlets:

- Modular.
- 4-prong jack.
- Hard-wired type.

Modular Jack

Plug the telephone line cord from the Base Unit into a standard modular telephone jack.

Note: *If you do not have a modular jack, contact your local telephone company for information on the installation of these jacks.*

4-Prong Jack

An adapter (not included) is required. The adapter plugs into the 4-prong jack and the telephone line cord plugs into the adapter.

Hard-wired Jack

A modular jack converter (not included) is required. You may need to rewire when connecting the converter (making color-coded connections).

Note: *Your Uniden Cordless Telephone Dealer or a telephone supply store can advise you on the proper adapter or converter.*

CAUTION:

- Never install telephone wiring during a lightning storm.
- Never install telephone jacks in wet locations unless the jack is specifically designed for wet locations.
- Never touch uninsulated telephone wires or terminals unless the telephone line has been disconnected at the network interface.
- Use caution when installing or modifying telephone lines.

Setting the TONE/PULSE Switch

Place the switch in the TONE position for tone dialing, or the PULSE position for pulse dialing.

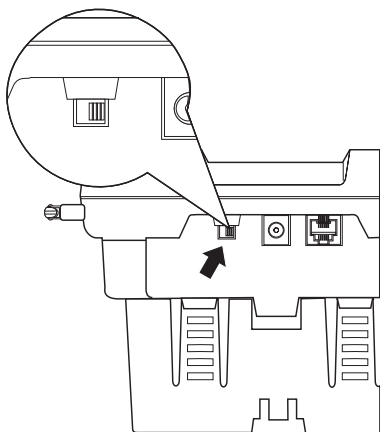

Installing the Base Unit on a Desk or Tabletop

1. Install the Base Stand on the base.

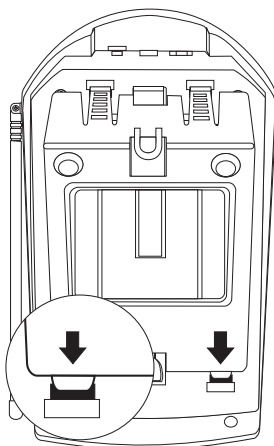

2. Plug the AC Power Cord (1) and the Telephone Line Cord (2) into the base.

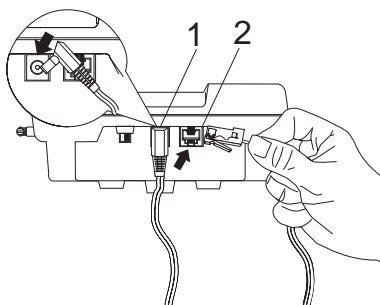

3. Thread the AC Power Cord through the clip on the base stand, and place the Base Unit on the desk or table top.

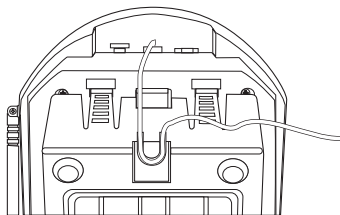

4. Raise the antenna on the Base Unit.

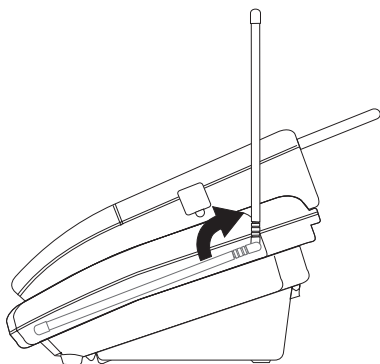

5. Plug the other end of the Telephone Line Cord into the telephone wall jack. Plug the AC Adapter into a standard 120V AC wall outlet.

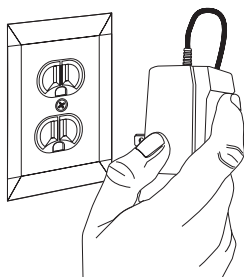
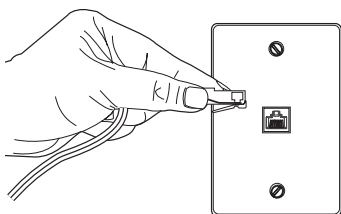

Note: Use only the AC Adapter supplied with the EXP900.



6. Route the telephone and power cords where they will not create a trip hazard, or where they could become chafed and create a fire or other electrical hazards.

Mounting the Base Unit on a Wall

Setting the Handset Retainer

1. Remove the Handset Retainer on the Base Unit by sliding it upward.

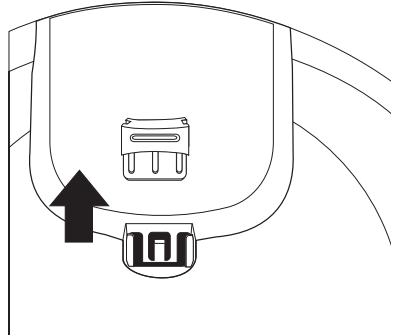
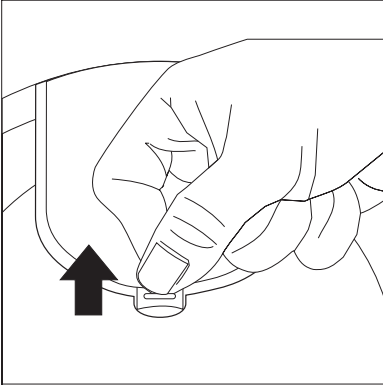

2. Flip the Retainer over so the tab is facing up, and slide the Retainer back into the Base Unit.

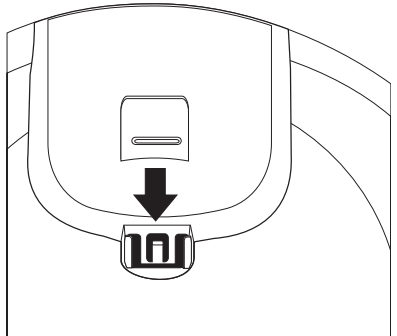
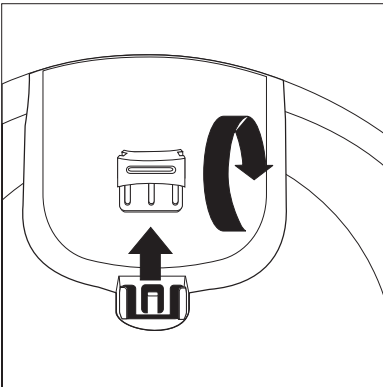

Mounting on a Standard Wall Plate

The EXP900 is designed to be mounted on a standard AT&T or GTE wall plate.

1. Plug the AC Power Cord (1) and the Short Telephone Cord (2) into the base.

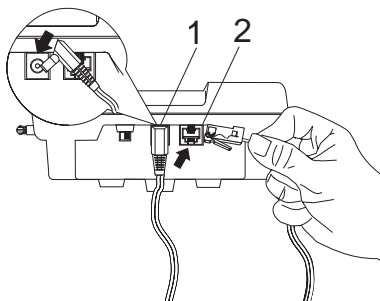

2. Place the power cord in the left molded channel on the bottom of the Base Unit.

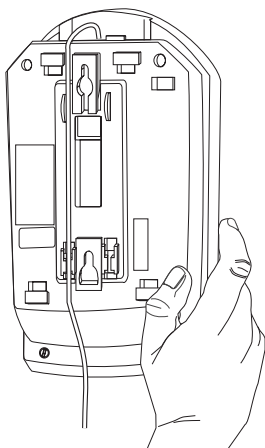

3. Plug the short telephone cord into the phone and the GTE Wall Plate jack. Place the Base Unit on the two posts of the wall plate and slide downward to secure.

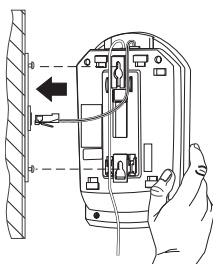

4. Raise the antenna on the Base Unit.

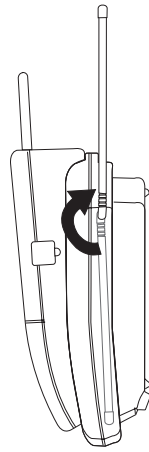

5. Hang the Handset on the Base Unit.
6. Plug the AC Adapter into a standard 120V AC wall outlet.

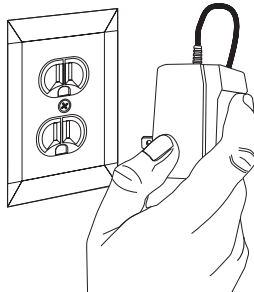

Note: Use only the AC Adapter supplied with the EXP900.



7. Route the power cord where it will not create a trip hazard, or where it could become chafed and create a fire or other electrical hazards.

Mounting Directly on a Wall

If you do not have a standard wall plate, you can mount the EXP900 directly on a wall. Before mounting your cordless telephone, consider the following:

- Select a location away from electrical cables, pipes, or other items behind the mounting location that could cause a hazard when inserting screws into the wall.
- Make sure the wall material is capable of supporting the weight of the Base Unit and Handset.
- Use #10 screws with anchoring devices suitable for the wall material where the Base Unit will be placed.

1. Insert two number 10 screws, with the appropriate anchor device, in the wall $3 \frac{5}{16}$ inches apart vertically, allowing about $\frac{1}{5}$ of an inch between the wall and screw heads for mounting the phone. Make sure the screws are securely fastened, and that the wall material is capable of supporting the weight of the Base Unit; otherwise, damage to the Base Unit could result.

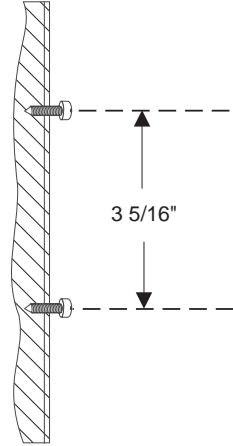

2. Plug the AC Power Cord (1) and the Long Telephone Cord (2) into the Base Unit.

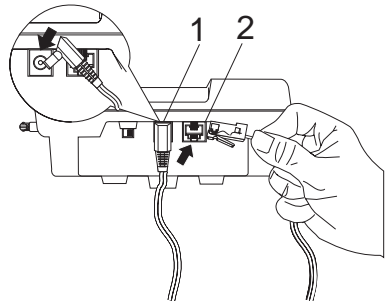

3. Place the power cord (1) in the right molded channel and the telephone cord (2) in the left molded channel on the bottom of the Base Unit.

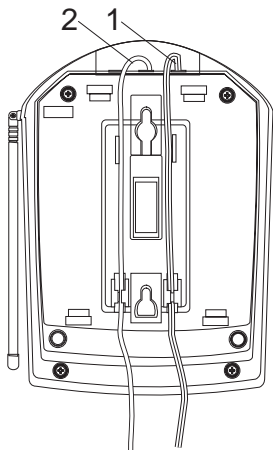

4. Place the Base Unit on the two screws in the wall and slide downward to secure.

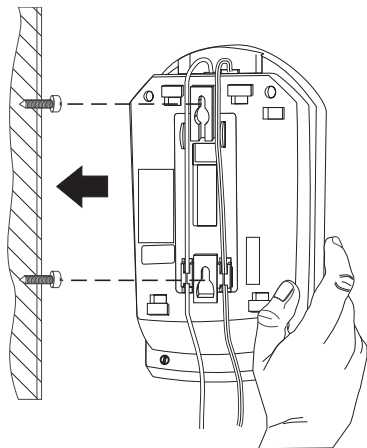

5. Raise the antenna on the Base Unit.

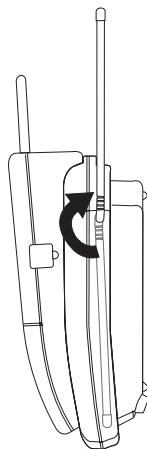

6. Hang the Handset on the base unit.

7. Plug the other end of the Telephone Line Cord into the telephone wall jack. Plug the AC Adapter into a standard 120V AC wall outlet.

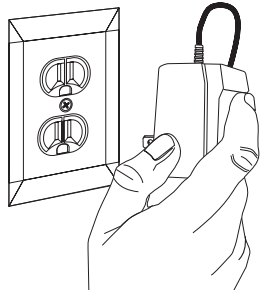
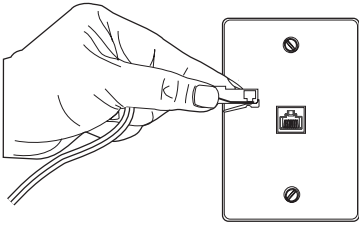

Note: Use only the AC Adapter supplied with the EXP900.



8. Route the telephone and power cords where they will not create a trip hazard, or where they could become chafed and create a fire or other electrical hazards.

Installing the Battery Pack

Note: *The built-in Memory Backup feature allows up to 3 minutes after disconnecting the old Battery Pack to install a new one without losing any phone numbers that may be stored in the telephone's memory.*

Remove the handset battery cover and install the Lead Acid battery. Do not let the battery become fully discharged. Be sure to place the handset in the base at night. Always charge a new battery fully before using it.

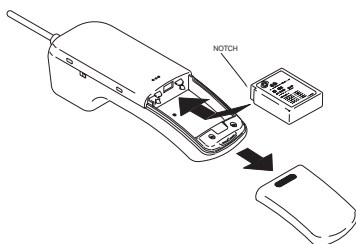

Note: *For optimum battery performance, please charge the battery overnight before using the system.*

Installing the Belt Clip

Push the Belt Clip onto the handset until it snaps into place.

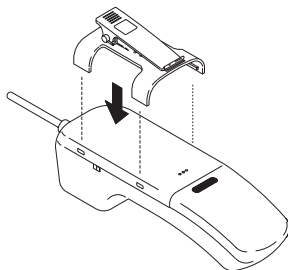

Charging the Handset

Place the handset on the base to charge.

Low Battery Indicator

When the Battery Pack in the Handset is low and needs to be charged, the **BATT LOW LED** flashes every 3 seconds.

If this occurs while you are on the phone, you hear an alert tone. Complete your call as quickly as possible, and return the Handset to the Base Unit for charging.

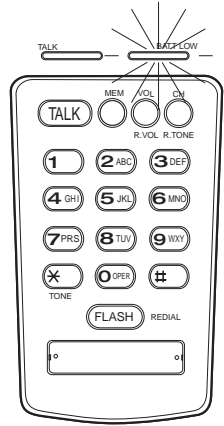

Allow 12 to 16 hours without any interruption for the Handset to fully recharge.

Cleaning the Battery Contacts

To maintain a good charge, it is important to clean all battery contacts on the Handset and Base Unit about once a month. Use a pencil eraser or other contact cleaner. Do not use any liquids or solvents.

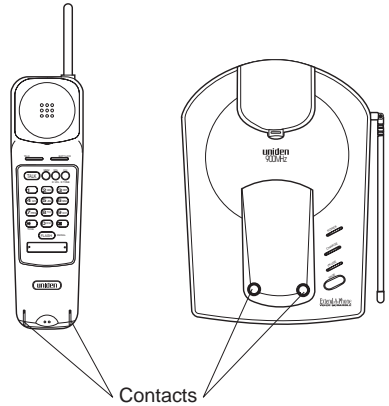

Operating Instructions

Using the Optional Headset (HS900)

1. Open the black rubber cover.

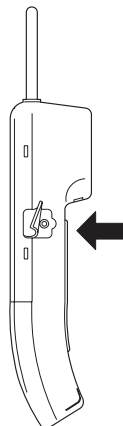

2. Plug the optional headset into the jack on the left side of the EXP900 handset.

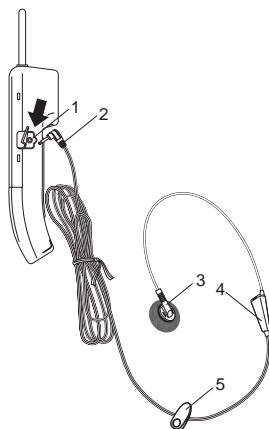

Note: *The earpiece and microphone in your cordless handset are disabled when the headset is plugged in. We suggest you use the Uniden HS900 Headset. This headset is specifically designed to deliver optimum performance. Use of other headsets may result in less than satisfactory performance.*

Placing a Call

When the Handset Is on the Base

1. Remove the Handset from the Base Unit and press **TALK**.

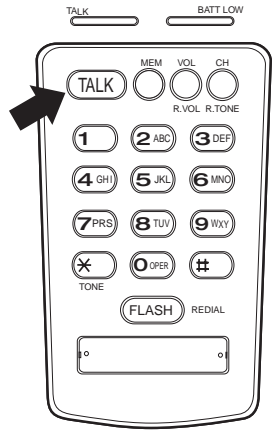
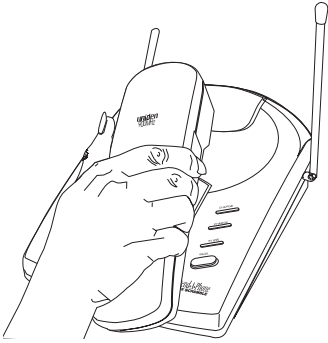

2. The **TALK LED** will light up.

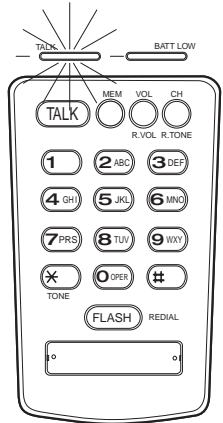

3. Dial the number you are calling.

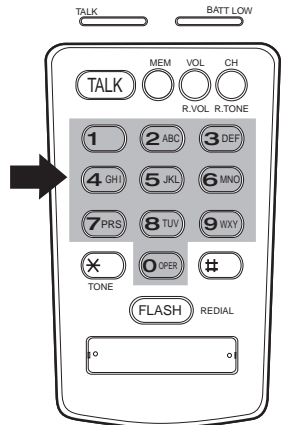

- When you have finished the call, return the Handset to the Base Unit to hang up.

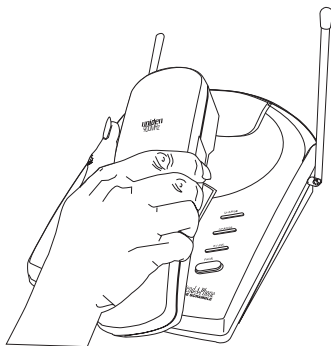

When the Handset Is off the Base

- Pick up the handset and press **TALK**.

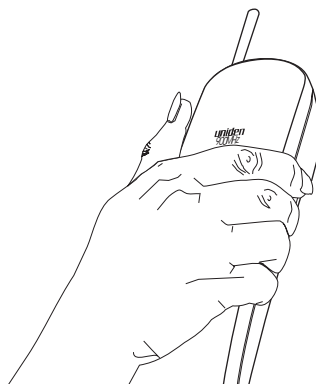

- The **TALK LED** will light up.

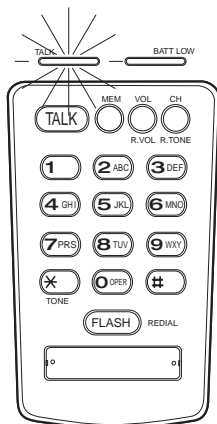
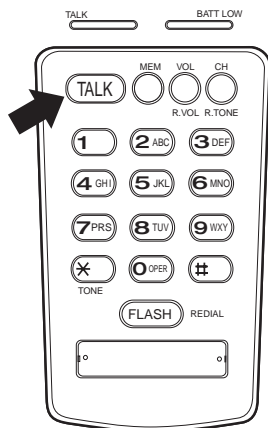

3. Dial the number you are calling.

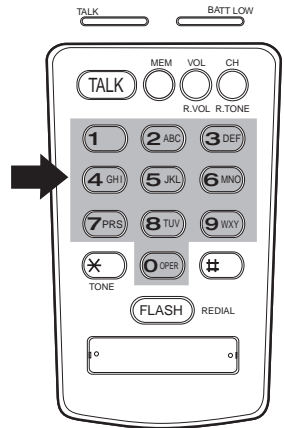

4. When you have finished the call, press the **TALK** button to hang up.

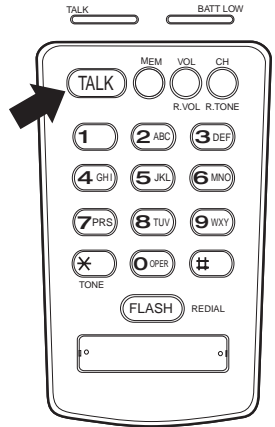

Answering a Call

When the Handset Is on the Base

1. When the EXP900 rings, remove the handset from the base.

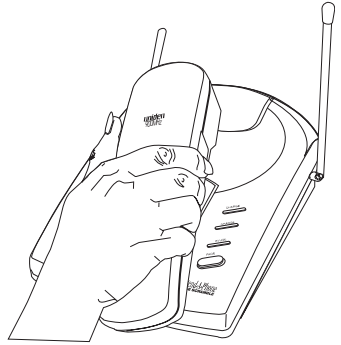

2. The **TALK LED** will light up, indicating a connection has been made.

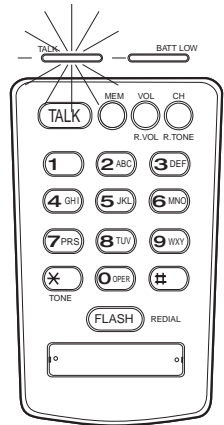

3. After you are finished with your conversation, return the handset to the base to hang up.



When the Handset Is off the Base

1. When the EXP900 rings, pick up the handset and press any key.

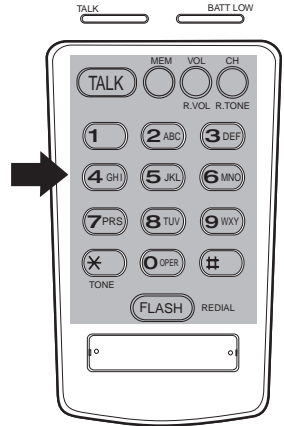
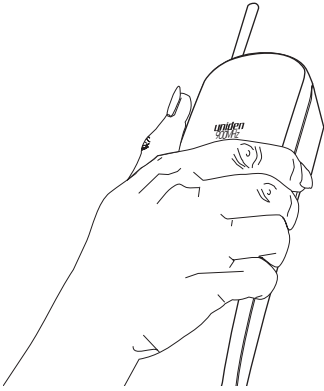

2. The **TALK LED** will light up, indicating a connection has been made.

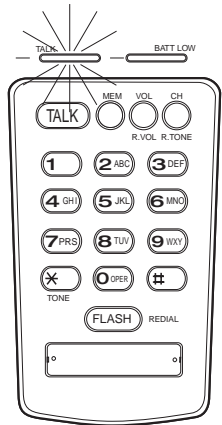

3. After you are finished with your conversation, press the **TALK** button to hang up.

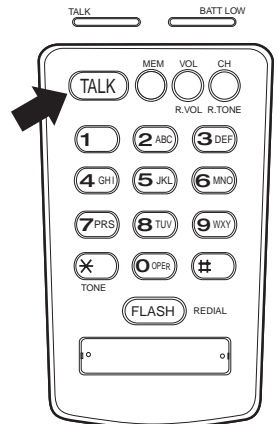

Selecting a Channel

Note: *If you have more than one cordless phone in your house, they must be set to different channels. This function works only when the phone is in use.*

The **CH/R.TONE** button on the Handset allows you to choose among 40 factory set channels. During the course of a conversation if you hear static or noise causing difficulty in hearing the other party, change channels by:

1. Pressing the **CH/R.TONE** button.

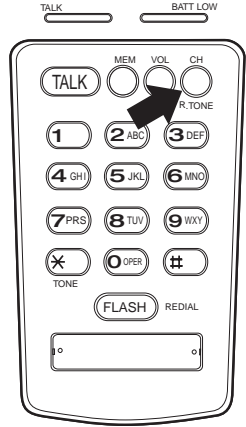

2. The **TALK LED** will flash, indicating the EXP900 is finding the best channel available.

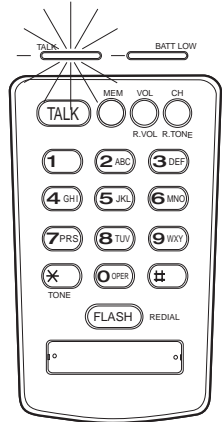

Using the Flash Button

Use **FLASH**/**REDIAL** to send a timed “hook-flash” on the telephone line for accessing services such as call waiting, etc.

1. Press the **FLASH**/**REDIAL** button on the Handset during your conversation.

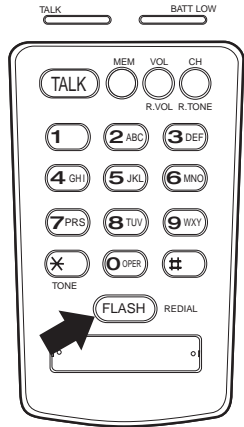

Setting the Handset Receiver Volume

1. While on a phone call, press the **VOL/R.VOL** button on the Handset.

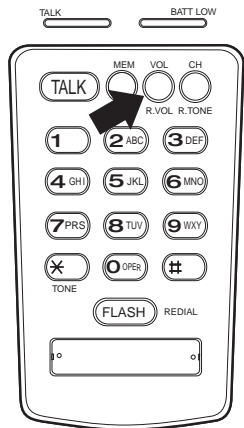

2. You will hear a tone indicating a decrease in the earpiece volume.
3. Press the **VOL/R.VOL** button again to increase the earpiece volume to the higher level.

Using the Redial Button

The **FLASH**/**REDIAL** button dials the last number that you called.

1. Press **FLASH**/**REDIAL**. The last number called is dialed again.

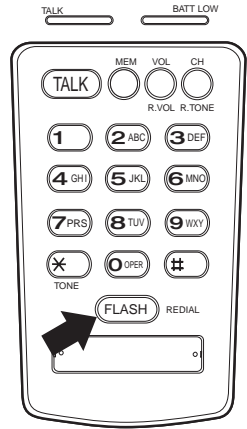

Note: If any other key is pressed before **FLASH**/**REDIAL**, the phone will not redial the last number.

Storing a Number in Memory

To store a number in memory:

1. Remove the Handset from the Base Unit and press **MEM**.

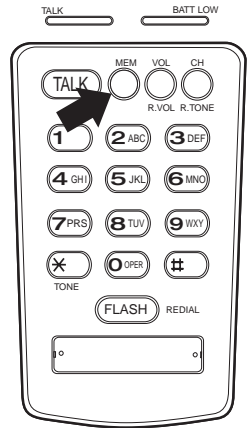
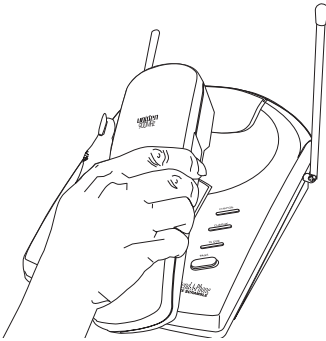

2. The **TALK LED** flashes and you hear a beep.

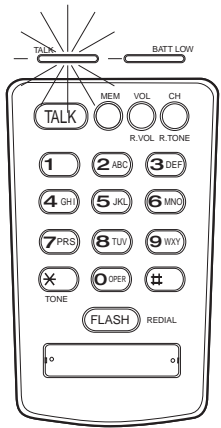

3. Enter the number (up to 16 digits) you want to store.

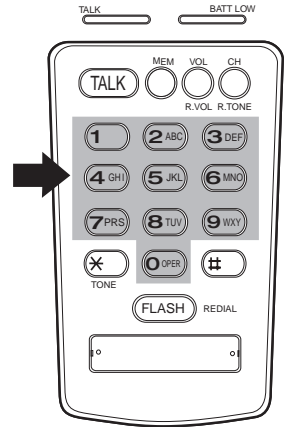

Note: You have 20 seconds after pressing **MEM** to enter the number you wish to store. Otherwise, an error tone will sound.

4. Press **MEM**.

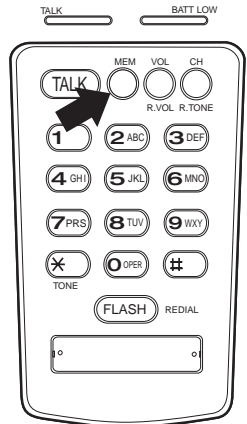

5. Enter a number (0-9) for the memory location you wish to use.

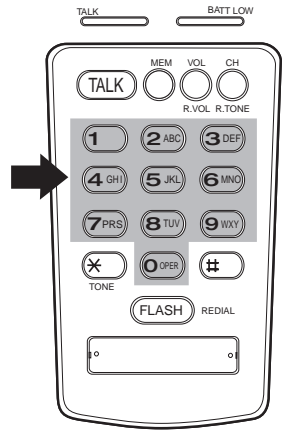

Note: If you select any key other than 0-9, the Handset will beep rapidly and no number will be stored.

6. You hear a long beep and the **TALK LED** goes out indicating the number has been stored successfully.

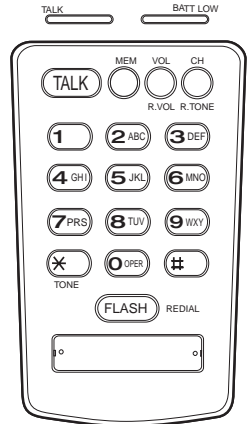

7. Write the stored number and its memory location number on one of the enclosed stickers.

Storing a Mixed Tone/Pulse Number with a Pulse Dial System

If your phone is set up for Pulse Dialing, you can store a mixed mode number (up to 16 digits) to easily access long distance services.

1. Remove the Handset from the Base Unit and press **MEM**.

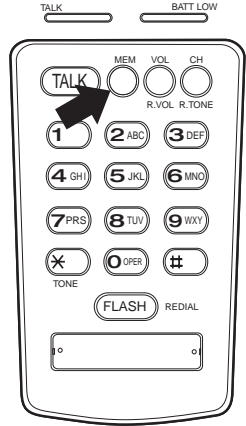
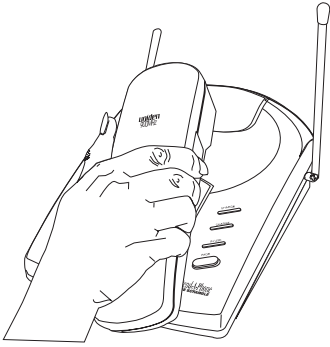

2. The **TALK LED** flashes and you will hear a beep.

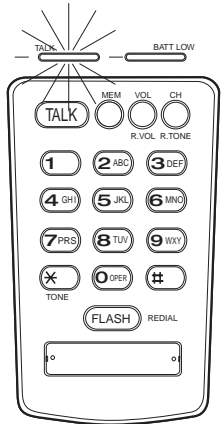

3. Enter the number to be dialed in Pulse Mode.

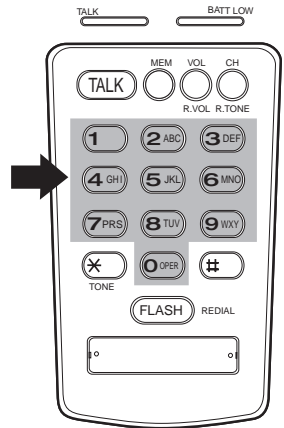

Note: You have 20 seconds after pressing **MEM** to enter the number you wish to store. Otherwise, an error tone will sound.

4. Press the ***TONE** button on the Handset. The ***TONE** button counts as one digit.

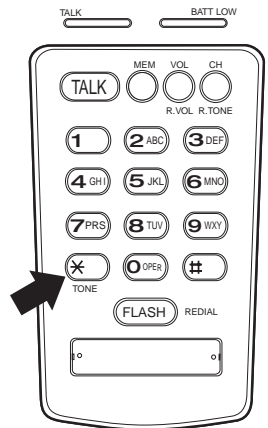

5. Enter the number to be dialed in Tone Mode.

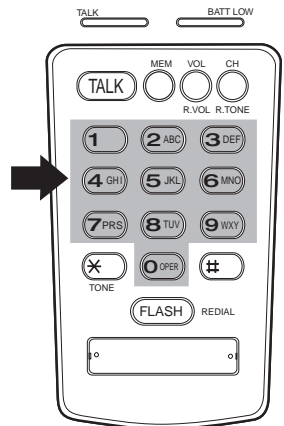

6. Press **MEM** and a number (0-9) for the memory location you wish to use.

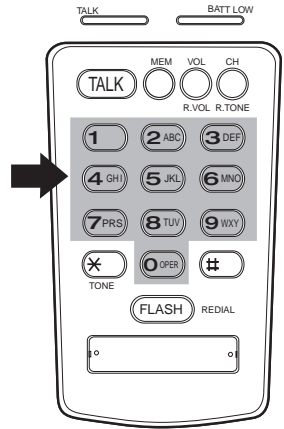
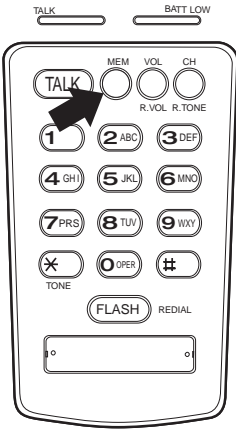

Note: If you select any key other than 0-9, the Handset will beep rapidly and no number will be stored.

7. You hear a long beep and the **TALK LED** goes out.

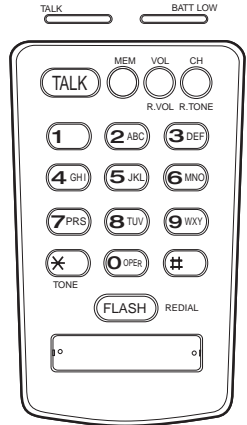

8. Write the stored number and its memory location number on one of the enclosed stickers.

Dialing a Stored Number

To dial a number previously stored in memory, press **TALK**, then press **MEM** and the memory number (0-9). Your EXP900 will then dial the previously stored number.

Note: If you select a memory location that does not have a stored number, the Handset will beep rapidly and will not dial.

Chain Dialing

On certain occasions, after dialing a number, you may be requested by the party or service you are calling to enter a special access code, such as when performing a banking transaction.

1. Store the access code into one of the memory numbers.
2. Dial the main number.

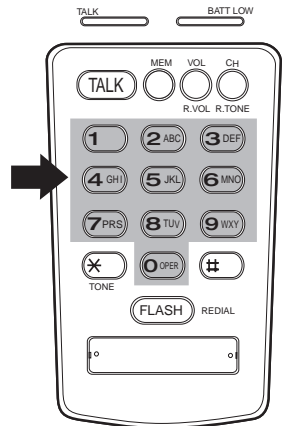

3. Press **MEM** and the memory number of the access code at the appropriate time.

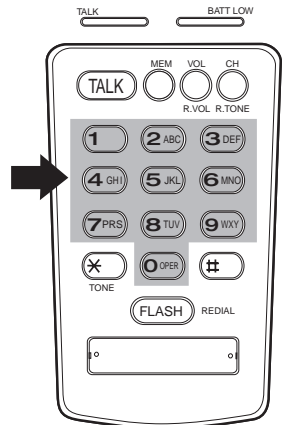
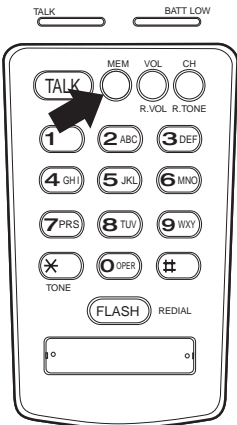

Erasing a Stored Number

1. Remove the Handset from the Base Unit.

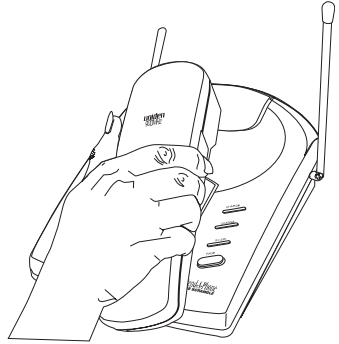

2. Press **MEM** twice.

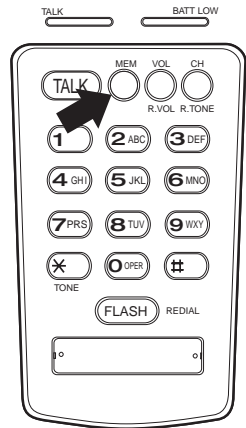

3. Press the memory location number (0-9) you want to clear. You will hear a long beep confirming that you have erased the number.

Using the Page Feature

The Page feature sends a signal from the Base Unit to the Handset causing it to beep. This is useful for locating the Handset when it is away from the Base Unit.

1. Press the **PAGE** button on the Base Unit.

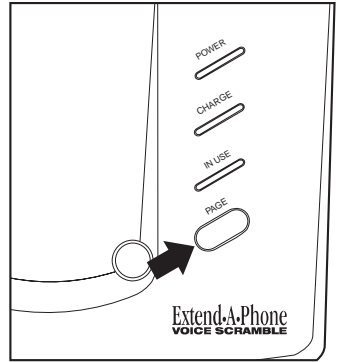

2. The handset beeps several times.

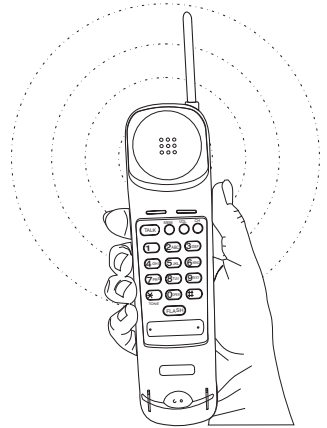

Note: *The Page feature does not work when the phone is in use or when the Handset **RING ON/RING OFF** switch is in the **RING OFF** position.*

Turning the Ringer Off

To turn the handset ringer off, put the Ring On/Ring Off switch in the Ring Off position.

CAUTION: If the **RING ON/RING OFF** switch is in the **RING OFF** position, the **EXP900** will not ring while away from the base.

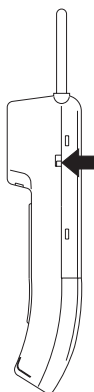

Setting the Ring Type

There are 2 ring types that can be selected while your EXP900 is in the "Standby" mode. Be sure the **TALK LED** is not lit on your EXP900 portable handset.

1. Press the **CH/R.TONE** button to change between the 2 different rings.

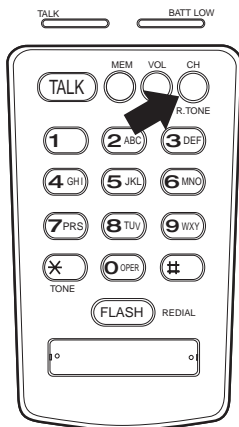

Setting the Ring Volume

1. Press the **VOL/R.VOL** button to change the ringer volume. The ringer volume changes between high and low each time the button is pressed.

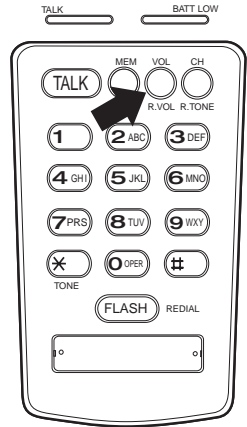

Troubleshooting

If your EXP900 Cordless Telephone is not performing to your expectations, please try these simple steps. If you are still unable to resolve the problems, contact your place of purchase.

Note: *Do not attempt to service this unit yourself. All service must be done by qualified service personnel.*

| Problem | Suggestion |
|---|---|
| Base Unit Power light does not come on. | Make sure the AC Adapter is plugged into the Base Unit and wall outlet. |
| Charge light won't come on when Handset is placed in Base Unit. | Make sure the AC Adapter is plugged into the Base Unit and wall outlet. Make sure the Handset is properly seated in the Base Unit. Make sure the Lead Acid Battery Pack is properly placed in the Handset. Make sure that the charging contacts on the Handset and on the Base Unit are clean. |
| Conversation interrupted frequently. | Make sure that the Base Unit antenna is fully vertical. Move closer to the Base Unit. Change Channels. |
| Handset doesn't ring. | Lead Acid Battery may be weak or not charged fully. Charge the Battery Pack for 4-5 hours. Check the Ringer On setting. It may be on Ringer Off. Make sure the Base Unit antenna is fully vertical. The Handset may be too far away from the Base Unit. Check the AC supply. |

Range

The EXP900 is designed to achieve the maximum possible range by transmitting and receiving according to the highest specifications set forth by the FCC. We have rated this phone to operate at a maximum distance with the qualification that the range depends upon the environment in which the telephone is used. Many factors limit range, and it would be impossible to include all the variables in our rating. The Maximum Range rating of the EXP900 is meant to be used as a means of comparison against other range claims.

Radio Interference

Radio interference may occasionally cause interruptions in your conversations. When this happens, remember that your unit is not defective. If these noises continue and are too distracting, move to a different location while you are talking on the phone or change channels on your cordless handset.

Optional Accessories and Replacement Parts

For the following Optional Accessories and Replacement Parts, contact Uniden Customer Service at **1-800-297-1023**.



Headset HS900

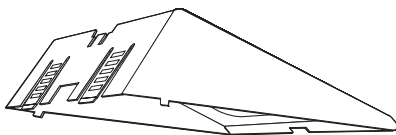

Base Stand

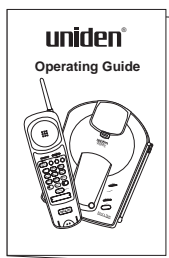

Operating Guide
UDZZ01804ZZ

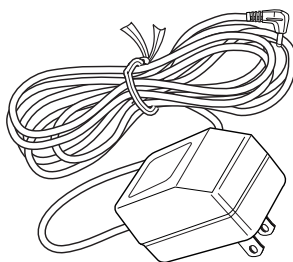

AC Adapter

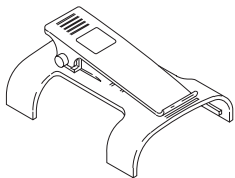

Belt Clip



Lead-Acid Battery
BT9000B

Specifications

General

| | |
|-----------------------|-------------------|
| Frequency Control | Phase Locked Loop |
| Modulation | FM |
| Operating Temperature | -10° - 50° C |

Base Unit

| | |
|--------------------|-------------------------------------|
| Transmit Frequency | 926.000 ~ 927.950 MHz (40 Channels) |
| Power Requirements | 9V 350mA (from AC Adapter) |
| Size | 5.3 in. W X 2.2 in. D X 7.7 in. H |
| Weight | Approximately 20 oz. |

Handset

| | |
|--------------------|-------------------------------------|
| Transmit Frequency | 902.050 ~ 904.000 MHz (40 Channels) |
| Size | 2.2 in. W X 2 in. D X 9.75 in. H |
| Weight | Approximately 10 oz. |

Battery

| | |
|--------------|-------------|
| Capacity | 500 mAH, 4V |
| Talk Mode | 5 hours |
| Standby Mode | 5 days |

Specifications shown are typical and subject to change without notice.

uniden® EXP900

Cordless Telephone Operating Guide



UDZZ01804ZZ

Precautions

Before you read anything else, please observe the following:

WARNING!

Uniden America Corporation **DOES NOT** represent this unit to be waterproof. To reduce the risk of fire, electrical shock, or damage to the unit, **DO NOT** expose this unit to rain or moisture.

Lead Acid Battery Precautions

Before you read anything else, please observe the following:

LEAD ACID BATTERY WARNING

This equipment contains a rechargeable sealed Lead Acid Battery.

The rechargeable sealed Lead Acid Battery contained in this equipment may explode if disposed of in a fire.

Do Not short-circuit the battery.

Do Not charge the rechargeable sealed Lead Acid Battery used in this equipment in any charger other than the one designed to charge this battery as specified in this guide. Using another charger may damage the battery or cause the battery to explode.

IMPORTANT NOTICE

Do Not allow the battery to drain fully. Once drained fully, the Lead Acid Battery cannot be recharged. If the battery becomes low, place the handset in the base and recharge it fully before using it again.

RECHARGEABLE LEAD ACID BATTERIES MUST BE RECYCLED OR DISPOSED OF PROPERLY

Residents of Minnesota should call 1-800-225-PRBA for information concerning reclamation and disposal of rechargeable Lead Acid batteries.

Residents outside of Minnesota should contact their local authorities for information concerning reclamation and disposal of rechargeable Lead Acid batteries.



This symbol is intended to alert the user to the presence of important operating and maintenance (servicing) instructions in the literature accompanying the appliance.

Base Controls and Indicators

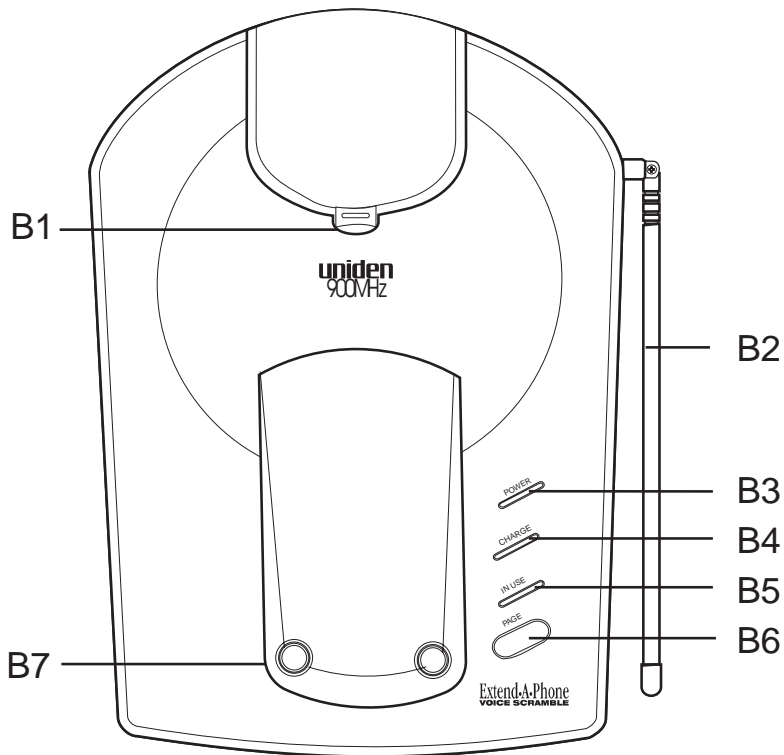

- B1 Handset Retainer - Used to hold handset in base for wall mounting.
- B2 Antenna - Sends and receives signals to and from handset.
- B3 POWER LED - AC Power applied to base.
- B4 CHARGE LED - Handset Charging.
- B5 IN USE LED - Handset in use.
- B6 PAGE KEY - Page or find handset.
- B7 Charging Contacts.

Handset Controls

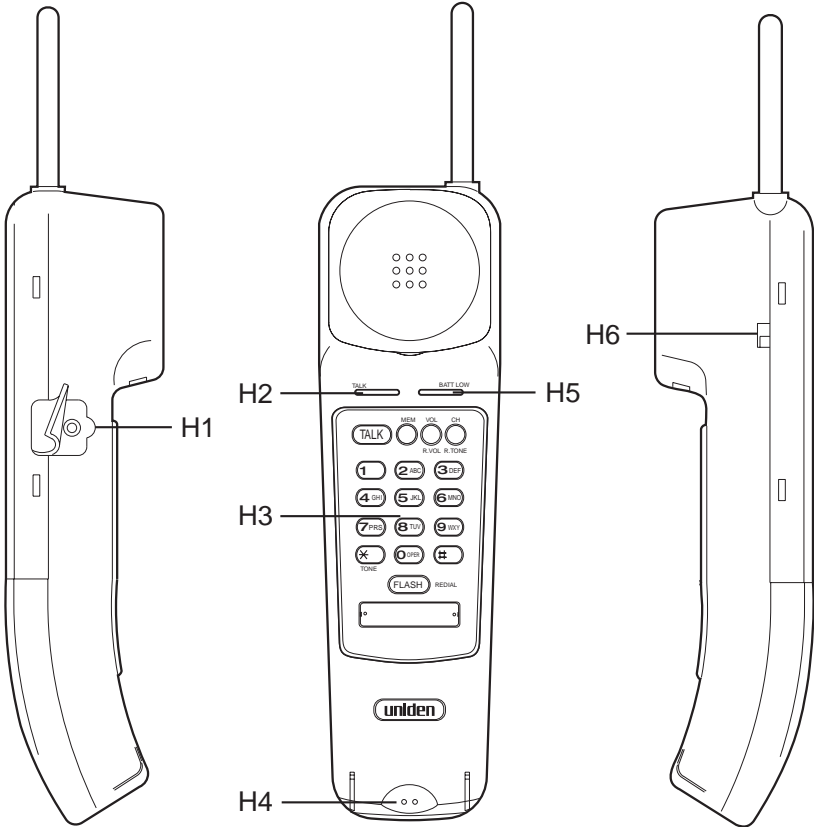

Front

- H1 Headset Jack
- H2 TALK LED
- H3 Keypad
- H4 Microphone
- H5 BATTERY LOW LED
- H6 RINGER ON/RINGER OFF Switch

Keypad

- K1 TALK Key
- K2 Numeric Keypad
- K3 Star Key
- K4 Memory Key
- K5 VOL/R.VOL Key
- K6 CH/R.TONE Key
- K7 Pound Key
- K8 FLASH/REDIAL Key

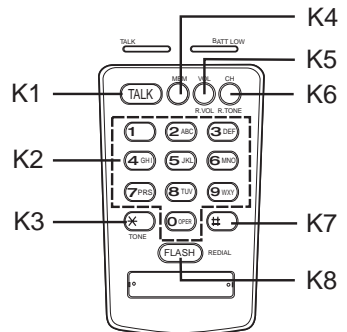

Table Of Contents

| | |
|--|---------------------------|
| Base Controls and Indicators | Inside Front Cover |
| Handset Controls | Foldout |
| Important Safety Instructions | 1 |
| Introduction | 3 |
| About the EXP900 | 3 |
| Features | 3 |
| What's Included with Your EXP900 | 4 |
| Installation | 5 |
| Installing Your EXP900 | 5 |
| Selecting the Installation Location | 5 |
| Connecting the Telephone Line | 5 |
| Setting the TONE/PULSE Switch | 6 |
| Installing the Base Unit on a Desk or Tabletop | 6 |
| Mounting the Base Unit on a Wall | 8 |
| Installing the Battery Pack | 14 |
| Installing the Belt Clip | 14 |
| Charging the Handset | 15 |
| Low Battery Indicator | 15 |
| Cleaning the Battery Contacts | 15 |
| Operating Instructions | 16 |
| Using the Optional Headset (HS900) | 16 |
| Placing a Call | 17 |
| When the Handset Is on the Base | 17 |
| When the Handset Is off the Base | 18 |
| Answering a Call | 20 |
| When the Handset Is on the Base | 20 |
| When the Handset Is off the Base | 21 |
| Selecting a Channel | 22 |
| Using the Flash Button | 23 |
| Setting the Handset Receiver Volume | 23 |
| Using the Redial Button | 24 |
| Storing a Number in Memory | 24 |
| Storing a Mixed Tone/Pulse Number with a Pulse Dial System | 27 |
| Dialing a Stored Number | 30 |
| Chain Dialing | 30 |
| Erasing a Stored Number | 31 |
| Using the Page Feature | 32 |
| Turning the Ringer Off | 33 |
| Setting the Ring Type | 33 |
| Setting the Ring Volume | 34 |
| Troubleshooting | 35 |
| Range | 35 |
| Radio Interference | 36 |
| Optional Accessories and Replacement Parts | 37 |
| Specifications | 38 |
| General | 38 |
| Base Unit | 38 |
| Handset | 38 |
| Battery | 38 |

PRODUCT REGISTRATION CARD

uniden®

Thank you for choosing Uniden. This is your Uniden product registration card. The information on this card will enable us to better serve you with products developed to meet your needs and interests. Please take a moment right now to complete it.

As one more way of saying thank you, by completing and returning this card, you will be entered in our drawing held every six months for a free Uniden Cordless Telephone.

WIN A SECOND UNIDEN CORDLESS PHONE!!

There's nothing like the convenience of a Uniden Cordless Telephone. To have a chance at winning an *additional* phone, mail your completed registration card and you'll be entered in the Uniden Sweepstakes.

Official rules: No purchase is necessary to participate. Every six months one winner will be randomly selected from all cards received the previous six months. Entries must be postmarked by the last day of the previous six month period and are limited to one per household. Sweepstakes subject to termination without notice. Not responsible for late, lost, or illegible entries. Open to U.S. residents at least 18 years old, except employees and their families of the contest judge, Uniden, their subsidiaries and affiliates. Offer Void where prohibited by law. Odds of winning depend on the number of eligible entries received. Winner must agree to promptly execute an affidavit of eligibility. By submitting an entry, winner agrees to the use of his or her name, address, and photograph for advertising/publicity purposes without compensation. All entries become the property of Uniden and the contest judge. No transfer or substitution of prize is allowed. Winner is solely responsible for all taxes. For a notice of contest winners, send a self-addressed, stamped envelope to Uniden Contest Winners, 4700 Amon Carter Blvd., Fort Worth, TX 76155.

Thank you for purchasing this fine Uniden product.

Please complete the information below and return it promptly to help us better serve you, our customer.

① 1. Mr. 2. Mrs. 3. Ms. 4. Miss 39D

First Name: _____ Initial: _____ Last Name: _____

Address: (Number and Street) _____ Apt. #: _____

City: _____ State: _____ Zip: _____

② Phone Number: _____ ③ Date of Purchase: _____
Month Day Year

④ Name of Store Where Purchased: _____

⑤ Uniden Product Purchased: **CORDLESS TELEPHONE**

⑥ Serial Number: _____ ⑦ Model Number: _____
(located on the base) (example: XC 340)

⑧ Check the two (2) most important reasons influencing your purchase of this Uniden Product.

- 1. Uniden Reputation 4. Features 7. Style/Appearance
- 2. Previous Experience 5. Value for Price 8. Warranty
- 3. Received as a Gift 6. Quality/Durability 9. Other: _____

⑨ Check the two (2) most important features to you on a Uniden Cordless Phone.

- 1. Range 6. Intercom 11. Extra Charger
- 2. Battery Life 7. Dual Keypad 12. Wall Mountable
- 3. Clarity 8. Number of Channels 13. Color
- 4. Spread Spectrum 9. Call Monitor 14. One Touch Dialing
- 5. Speaker Phone 10. 2-Line Operation 15. Number of Memories

⑩ How did you first become aware of this product?

- 1. Previous Use 4. Newspaper Advertisement 7. Recommendation of Salesperson
- 2. Comparison Shopping 5. Magazine Advertisement 8. Recommendation of Friend / Family
- 3. In-Store Display 6. TV Advertisement 9. Direct Mail

⑪ Date of Your birth: _____
Month Day Year

⑭ Including children, what are the ages of the other people (in years) that live in your house?

⑫ What is your occupation? Age

- 1. Self Employed / Owner Male: _____
- 2. Professional / Technical
- 3. Clerical / Service Worker Female: _____
- 4. Middle Management
- 5. Upper Management
- 6. Professional Driver
- 7. Civil Servant
- 8. Farming / Agriculture
- 9. Laborer / Tradesman
- 10. Sales / Marketing
- 11. Retired
- 12. Military
- 13. Homemaker
- 14. Student

⑮ What best describes your family income?

- 1. Under \$15,000 4. \$50,000-\$74,999
- 2. \$15,000-\$24,999 5. \$75,000-\$100,000
- 3. \$25,000-\$49,999 6. Over \$100,000

⑯ In the last six (6) months have you or your spouse:

- 1. Purchased clothes through the mail?
- 2. Purchased gifts through the mail?
- 3. Worked in your garden?
- 4. Traveled on vacation?
- 5. Purchased through television shopping?
- 6. Purchased a PC or PC software?

⑰ Education (Please check which category applies):

- 1. High School 3. Completed College
- 2. Some College 4. Graduate School

Thank you for filling out this questionnaire. Your answers are important to us. Please check here [] if you would prefer not to participate in additional market research for Uniden or obtain information on new and interesting opportunities.

One Year Limited Warranty

Important: Evidence of original purchase is required for warranty service.

WARRANTOR: UNIDEN AMERICA CORPORATION (“Uniden”)

ELEMENTS OF WARRANTY: Uniden warrants, for one year, to the original retail owner, this Uniden Product to be free from defects in materials and craftsmanship with only the limitations or exclusions set out below.

WARRANTY DURATION: This warranty to the original user shall terminate and be of no further effect 12 months after the date of original retail sale. The warranty is invalid if the Product is (A) damaged or not maintained as reasonable or necessary, (B) modified, altered, or used as part of any conversion kits, subassemblies, or any configurations not sold by Uniden, (C) improperly installed, (D) serviced or repaired by someone other than an authorized Uniden service center for a defect or malfunction covered by this warranty, (E) used in any conjunction with equipment or parts or as part of any system not manufactured by Uniden, or (F) installed or programmed by anyone other than as detailed by the Operating Guide for this product.

STATEMENT OF REMEDY: In the event that the product does not conform to this warranty at any time while this warranty is in effect, warrantor will repair the defect and return it to you without charge for parts, service, or any other cost (except shipping and handling) incurred by warrantor or its representatives in connection with the performance of this warranty. THE LIMITED WARRANTY SET FORTH ABOVE IS THE SOLE AND ENTIRE WARRANTY PERTAINING TO THE PRODUCT AND IS IN LIEU OF AND EXCLUDES ALL OTHER WARRANTIES OF ANY NATURE WHATSOEVER, WHETHER EXPRESS, IMPLIED OR ARISING BY OPERATION OF LAW, INCLUDING, BUT NOT LIMITED TO ANY IMPLIED WARRANTIES OF MERCHANTABILITY OR FITNESS FOR A PARTICULAR PURPOSE. THIS WARRANTY DOES NOT COVER OR PROVIDE FOR THE REIMBURSEMENT OR PAYMENT OF INCIDENTAL OR CONSEQUENTIAL DAMAGES. Some states do not allow this exclusion or limitation of incidental or consequential damages so the above limitation or exclusion may not apply to you.

LEGAL REMEDIES: This warranty gives you specific legal rights, and you may also have other rights which vary from state to state. This warranty is void outside the United States of America.

PROCEDURE FOR OBTAINING PERFORMANCE OF WARRANTY: If, after following the instructions in this Operating Guide you are certain that the Product is defective, pack the Product carefully (preferably in its original packaging). Include evidence of original purchase and a note describing the defect that has caused you to return it. The Product should be shipped freight prepaid, by traceable means, or delivered, to warrantor at:

**Uniden America Corporation
Parts and Service Division
4700 Amon Carter Boulevard
Fort Worth, TX 76155
(800) 297-1023, 8 AM to 5 PM Central, Monday through Friday**

Covered under one or more of the following U.S. patents:
4,511,761 4,523,058 4,597,104 4,797,916
4,803,491 5,157,686 5,253,268 5,381,460

uniden®

©1995 Uniden America Corporation
All Rights Reserved
Printed in Hong Kong

Free Manuals Download Website

<http://myh66.com>

<http://usermanuals.us>

<http://www.somanuals.com>

<http://www.4manuals.cc>

<http://www.manual-lib.com>

<http://www.404manual.com>

<http://www.luxmanual.com>

<http://aubethermostatmanual.com>

Golf course search by state

<http://golfingnear.com>

Email search by domain

<http://emailbydomain.com>

Auto manuals search

<http://auto.somanuals.com>

TV manuals search

<http://tv.somanuals.com>