

THANK YOU

FOR PURCHASING A UNIDEN PHONE!

**Uniden**<sup>®</sup>  
A Clear Signal of What's Ahead.

UNIDEN © 2000 Uniden Australia Pty Limited

OPERATING GUIDE

**Uniden**<sup>®</sup>  
**FP105**

*Caller ID on Call Waiting  
Speaker phone*

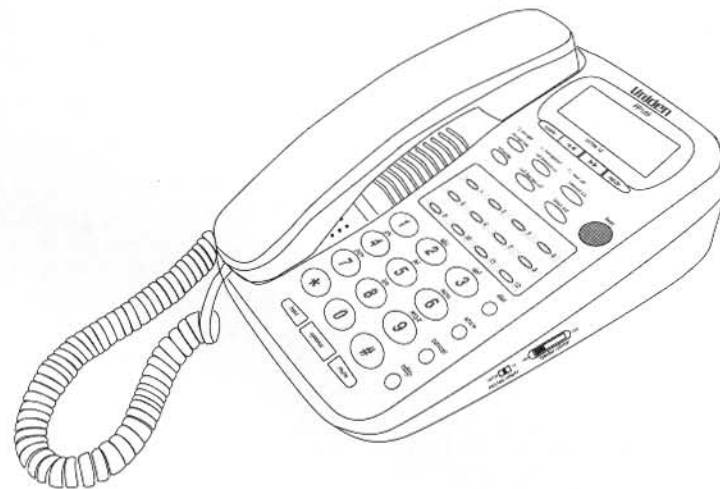

## IMPORTANT SAFETY INSTRUCTIONS

When using your telephone equipment, these basic safety precautions should always be followed to reduce the risk of fire, electrical shock, and injury to persons:

- 1) Read and understand all instructions. Follow all warnings and instructions marked on the product.
- 2) Do not use the telephone during an electrical storm to reduce the risk of an electric shock.
- 3) Unplug this product from the wall outlet before cleaning, and use a dry cloth, without liquid or aerosol cleaners.
- 4) Do not use this product near water; for example, near a bath tub, wash bowl, kitchen sink or laundry tub, in a wet basement or near a swimming pool.
- 5) Do not place this product on an unstable cart, stand or table. The telephone may fall, causing serious damage to the unit.
- 3) This product should be operated only from the type of power source indicated on the marking label. If you are not sure of the type of power supply to your home, consult your dealer or local power company.
- 7) Do not allow anything to rest on the power cord. Do not locate this product where the cord will be damaged by persons walking on it.
- 8) Do not overload wall outlets and extension cords, as this can result in the risk of fire or electrical shock.
- 9) Never push objects of any kind into this product through cabinet slots, as they may touch dangerous voltage points or short out parts that could result in a risk of fire or electric shock. Never spill liquid of any kind on the product.
- 10) To reduce the risk of electric shock, do not disassemble this product. Take it to qualified service personnel when service or repair work is required. Opening or removing covers may expose you to dangerous voltages or other risks. Incorrect re-assembly can cause electric shock when the appliance is subsequently used.



**The exclamation point is intended to alert the user to the presence of important operating and maintenance (servicing) instruction in the literature accompanying the appliance.**

### CARING FOR YOUR TELEPHONE

Clean your telephone using a soft damp cloth.

Do Not Use solvents, detergents, sprays, abrasive pads, scouring powder or other products that may damage your telephone.

Do Not place the telephone in direct sunlight.

Do Not Use in extreme humidity.

### CAUTION

You must not connect your phone to any of the following:

- Coin operated systems
- Party-line systems
- Most electronic key phone systems



**This unit is not waterproof. To reduce the risk of fire, electrical shock or damage, DO NOT expose this product to rain, water or any liquid or moisture.**

### IMPORTANT NOTES

We have designed your telephone to conform to local regulations and you can connect it to most telephone lines. However, each device that you connect draws power from the phone line. We refer to the power drawn as the device's Ringer Equivalence Number (REN or RN). This number is shown on the bottom of your telephone. If you are using more than one phone or other device on the line, add up all the RENs. If the total is more than 3, your phones may not ring.

PLEASE READ BEFORE USE AND SAVE THESE INSTRUCTIONS

## CONTENTS

<b>Important Safety Instructions</b> .....	1
<b>Contents</b> .....	2
<b>Introduction</b>	
Welcome .....	4
Included in Package .....	5
Features .....	6
Controls & Functions .....	7
<b>Installing your phone</b>	
Desk/table top installation .....	9
Wall mounting .....	12
<b>Using your phone</b>	
Making and receiving a call .....	13
Redial .....	13
Speakerphone .....	13
Adjusting the ringer volume .....	13
Adjusting the base speaker volume .....	13
Adjusting the handset volume .....	13
Adjusting the ringer tone .....	14
Placing a call on mute .....	14
Placing a call on hold .....	14
Music on hold .....	14
Storing one-touch speed dial memories .....	15
Pause .....	15
Memory storage card .....	15
Dialing stored numbers .....	16
Chain dialing .....	16
Call timer .....	16
LCD backlight display .....	16
Editing one-touch speed dial memories .....	17
Deleting one speed dial memory .....	17
Deleting all speed dial memories .....	17
Accessing call waiting using the call waiting button .....	18
Accessing call waiting using the flash button .....	18
Transmitting CID .....	18
Blocking CID .....	19
Call diversion on .....	19
Programming "Call Forward No Answer" numbers .....	19
Call diversion off .....	19
Message bank .....	20

33 memory Caller ID .....	21
Caller id on call waiting (CIDCW) .....	21
New call notification .....	21
New call review .....	22
Caller ID summary .....	22
Call review .....	22
Deleting a call from the call history .....	23
Deleting all calls from the call history .....	23
Speed dialing from the caller ID list .....	23
Transferring a call ID number to the speed dial memory .....	23
To store a name against a stored number.....	23
Call Display Messages.....	24
Message Bank Indicators.....	24
VIP .....	25
VIP alert on / off .....	25
Setting a VIP call .....	25
Reviewing VIP calls .....	25
Speed dialing from the VIP list .....	25
Resetting a VIP call .....	25
Deleting a VIP call .....	25
Name tagging .....	25
Setting the LCD contrast .....	27
Setting the time and date .....	27
Setting caller ID on call waiting on / off .....	27
Resetting the pre-programmed codes .....	27
Troubleshooting .....	23
Specifications .....	28
Warranty .....	30

# INTRODUCTION

TO YOUR NEW PHONE

WELCOME

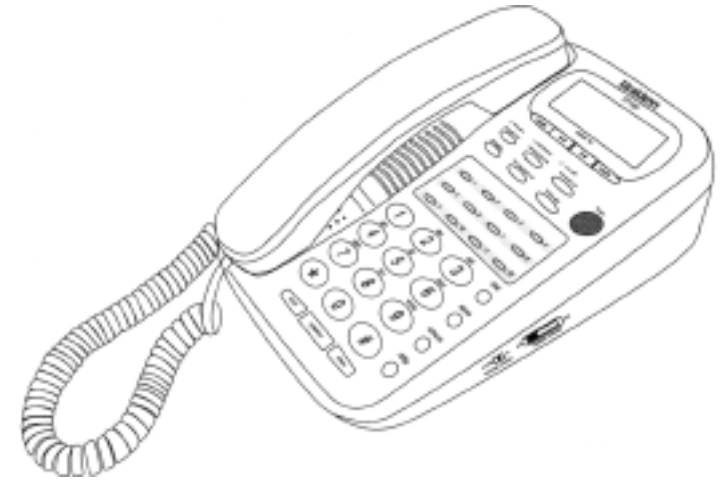

Congratulations on the purchase of your Uniden FP105 Telephone.

The FP105 has been designed and engineered to exacting standards for reliability, long life and outstanding performance.

To obtain the full benefit from your new telephone, please read this Operating Guide thoroughly.

For your future reference, please fill in the panel below and attach your Purchase Receipt / Sales docket.

Serial Number :  
(Found on the bottom of the product or box)

Date of purchase :

Name and address of Dealer :

## INCLUDED IN YOUR PACKAGE



Base Unit



Handset



Curly Cord



Telephone line cord and adaptor



AC Adaptor



Back-up Battery



2 x Wall mounting screws and plugs



Memory storage card

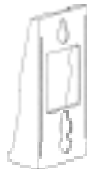

Wall mounting bracket



Operating guide

- Registration card
- Quick start guide

## FEATURES

### Telephone



- LCD with backlight
- Hands-free speaker phone
- On-hook dialling
- 12 one-touch speed dial
- 7 Pre-Programmed buttons
- Wall mountable
- Hearing aid compatible
- Call waiting compatible
- Redial, Flash and Pause
- Mute
- Music on hold
- Call timer
- ┆ Adjustable ringer volume control
- ┆ Adjustable ringer tone control
- ┆ Adjustable handset volume control
- ┆ Adjustable speaker phone volume control

### Display A. Call

- ┆ 33 memory Caller ID
- ┆ Caller ID on Call Waiting (CIDCW)
- ┆ Advanced Caller ID review functions
- ┆ VIP alert - 3 different ringer tones
- ┆ Name Tagging
- ┆ Visual Message Waiting Indicators



To get the most from your purchase, please read this Operating Guide thoroughly Also, be sure to complete the Product Registration Form.



If any of these items are missing or damaged, contact the place of purchase.

## CONTROLS AND FUNCTIONS

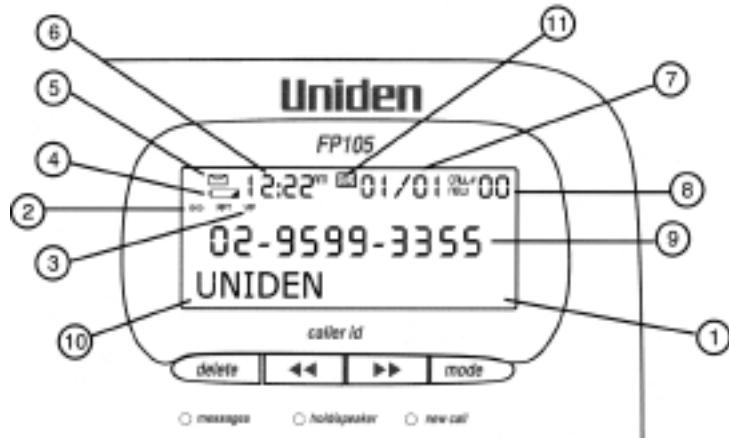

- |                                  |                       |
|----------------------------------|-----------------------|
| 1. LCD screen                    | 7. date               |
| 2. VIP on icon                   | 8. new call counter   |
| 3. VIP call icon                 | 9. numeric line       |
| 4. Low battery icon              | 10. alpha line        |
| 5. Message waiting envelope icon | 11. call waiting icon |
| 6. time                          |                       |

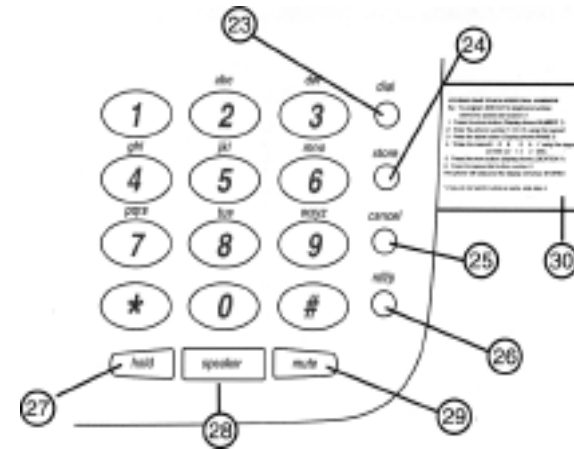

- |                           |
|---------------------------|
| 23. Dial button           |
| 24. Store button          |
| 25. Cancel button         |
| 26. Redial / Pause button |
| 27. Hold button           |
| 28. Speakerphone button   |
| 29. Mute button           |
| 30. Memory storage guide  |

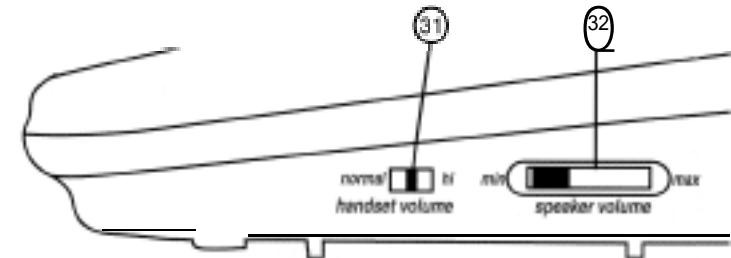

- |                                     |
|-------------------------------------|
| 31. Handset earpiece volume control |
| 32. Speakerphone volume control     |

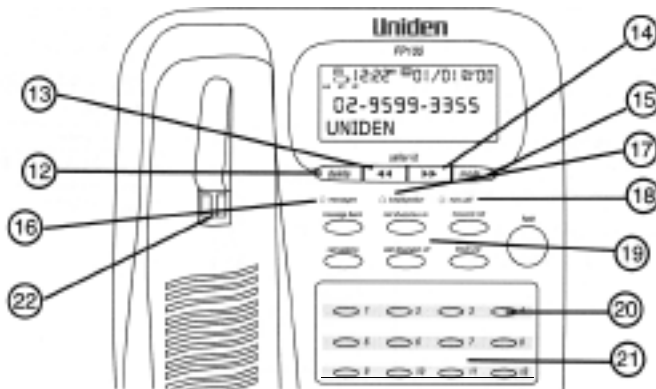

- |                             |  |
|-----------------------------|--|
| 12. Caller ID delete button | 18. New Call LED                           |
| 13. Scroll left button      | 19. 7 Pre-Programmed feature buttons       |
| 14. Scroll right button     | 20. 12 one-touch speed dial memory buttons |
| 15. Caller ID Mode Button   | 21. Memory storage card                    |
| 16. Message waiting LED     | 22. Handset retainer tab                   |
| 17. Hold / Speaker LED      |  |

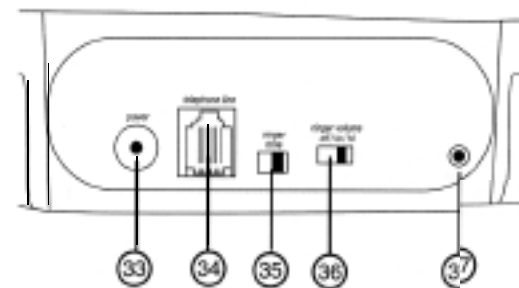

- |                             |
|-----------------------------|
| 33. AC adaptor power socket |
| 34. Telephone line socket   |
| 35. Ringer tone switch      |
| 36. Ringer volume control   |
| 37. Reset switch            |

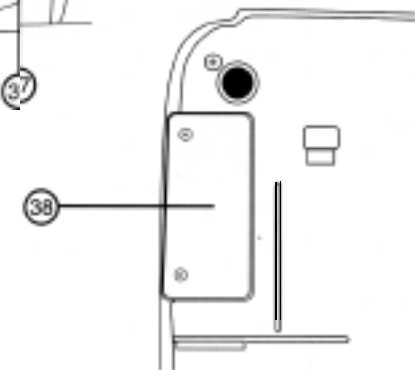

38. Battery cover underneath phone

**DESK/TABLETOP INSTALLATION**

1. Install the battery.
  - a. Use a Phillips screwdriver to remove the two screws on the battery compartment cover.



- b. Remove the battery compartment cover.
  - c. Snap the battery's contacts firmly to the battery connector, then place the battery inside the compartment.



- d. Replace the cover and secure with the screws.

**!** *Dispose of old batteries promptly and properly. Disconnect the telephone line cord before replacing the battery and always use a new 9V alkaline battery for optimum performance.*

**!** *Before choosing a location for your phone, please read the Important Safety Instructions on Page 1.*

2. Plug one end of the Handset Cord (curly) into the Handset and the other end into the jack on the side of the telephone.

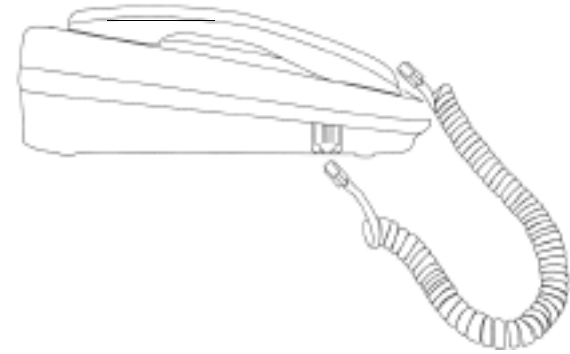

3. Plug one end of the line cord (straight) into the telephone line jack on the back of the telephone and the other end into the wall outlet.

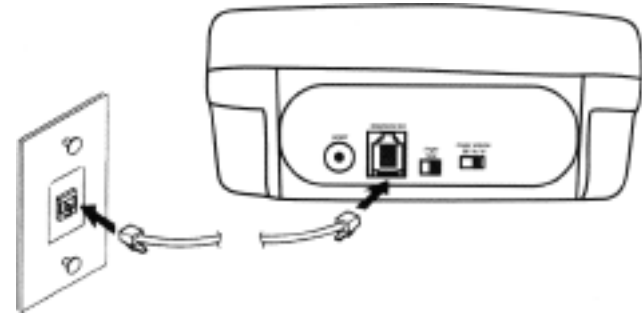

**NOTE** *Most phone equipment available now use modular jacks. Phone cords are fitted with a moulded plastic connector which plugs into this type of jack. If you do not have a modular jack, contact your local telephone company for information about their installation.*

**!** *Never install telephone wiring during a lightning storm. Never touch uninsulated telephone wires or terminals unless the telephone line has been disconnected. Use caution when installing or modifying telephone lines.*

4. Plug the AC Adaptor into a standard 230-240VAC wall outlet and switch it. Plug the AC Adaptor lead into the power socket at the back of the phone.

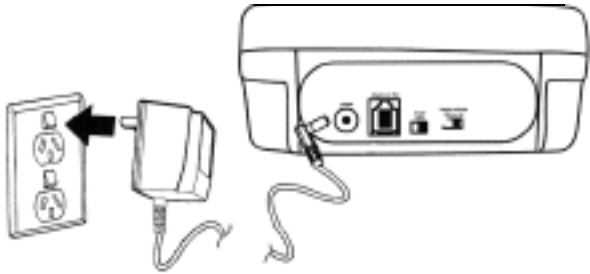

*Use only the AC adaptor supplied with this phone.  
Place the power cord and line cord so that they do not create a trip hazard or where they could become chafed and create fire or electrical hazard.*

The telephone will beep and the display will show SET TIME | DATE

Assuming you subscribe to a Caller ID service, the time and date will be automatically updated when the first call is received.

After 10 seconds the display will show **TOTAL CALLS 00**



*If you do not subscribe to a Caller ID service, or you wish to set the TIME/DATE manually p/ease refer to the Advance User Options Menu on page 27.*

### BACK UP BATTERY

- on the screen means;
- The back up battery is either low or not fitted.

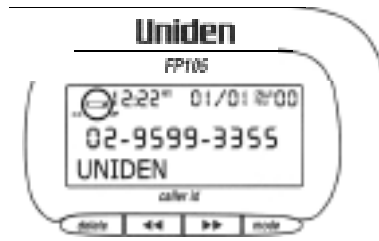

In case of power failure or accidental unplugging of the AC Adaptor, a 9V backup battery (supplied) will save the telephone's memory.

If required, you can mount your phone directly on the wall. Before mounting your phone, please consider the following:

- Select a location away from electrical cables, pipes or other items behind the mounting location that could cause a hazard when inserting screws into the wall.
- Make sure the wall material is capable of supporting the weight of the telephone.
- Use the screws (supplied) with anchoring devices suitable for the wall material where the telephone will be placed.

1. Insert two mounting screws 100mm apart. Allow about 5mm between the wall and screw heads for mounting the phone.

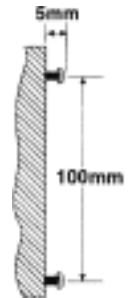

2. Gently pull out the handset retainer tab, turn 180° and re-fit.
3. Install battery.
4. Plug in the line cord and AC Adaptor jacks to rear side of the FP105.

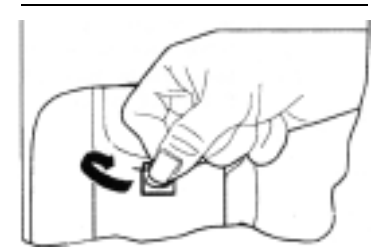

5. Attach the wall mounting bracket to the bottom of the telephone as shown.

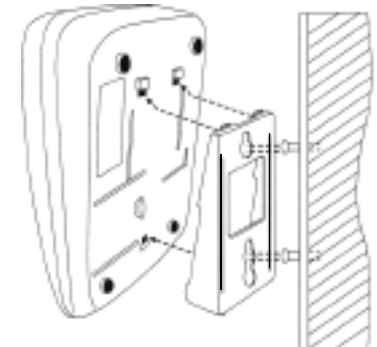

6. Place the base unit on the screws and push down until it's firmly seated.
7. Plug the other end of the telephone line cord to the wall and AC Adaptor to the AC outlet.

## MAKING AND RECEIVING CALLS

	HANDSET	SPEAKERPHONE
MAKING A CALL	1. Pick up the Handset from the Base. 2. Dial desired number. 3. Hang up upon completion of the call.	1. Key in desired telephone number. 2. Press <b>dial</b> button (The phone goes speakerphone mode automatically) 3. To hang up, press <b>speaker</b> key.
RECEIVING A CALL	1. Pick up the Handset from the Base. 2. Speak. 3. Hang up upon completion of the call.	1. Press <b>speaker</b> key. Speak. 2. To hang up, press <b>speaker</b> key again.

### ► REDIAL

If you want to redial the last number dialed simply pick up the handset or press the **speaker** button, then press the **rdl/p** button. The telephone will automatically redial the last number dialed.

### ► SPEAKPHONE

You can place a call on Speakerphone mode anytime by pressing the **speaker** button during a call, then place the Handset on the base. Also, you can transfer a call to the Handset anytime during a call by simple picking up the Handset.

## ADJUSTING VOLUME CONTROLS

### ► RINGER VOLUME

While the phone is ringing, you can adjust the ringer volume of your telephone by moving the **ringer volume** switch, located at the rear of the telephone, to the desired off/lo/hi position.



### ► BASE SPEAKER VOLUME

While on a call, adjust base **speaker volume** slider control, located at the right side of the telephone, to the desired level.



### ► HANDSET VOLUME

While on a call, adjust the **handset volume** switch, located at the side of the telephone, to the desired level.



## ADJUSTING RINGER TONE

While the phone is ringing, you can adjust the ringer tone of your telephone by moving the **ringer tone** switch, located at the rear of the telephone, to the desired tone.



## PLACING A CALL ON MUTE

Press the **mute** button to turn off the handset microphone, allowing private conversations in the same room without the other party hearing.

Press the **mute** button again to resume the conversation with the calling party.

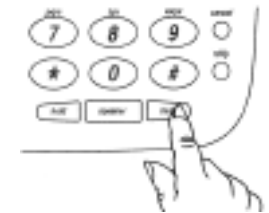

*During the mute condition, the display will show < MIC MUTE >.*

## PLACING A CALL ON HOLD

- To place a call on hold, press the **hold** button and hang up.

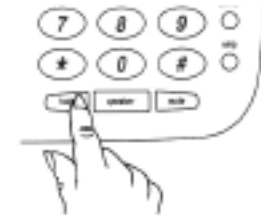

The hold/speaker LED will flash, the display will show < CALL ON HOLD >.

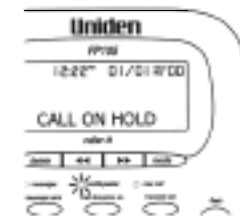

- To begin conversation again, pick up the handset or press the **speaker** button or pick up an extension phone (if available), the hold will then be automatically released.

### ► MUSIC ON HOLD

When a call is placed on hold, the telephone will play a popular melody to reassure your Caller that the call has not been disconnected.



## MEMORY DIAL NUMBERS

12 one-touch speed dial numbers can be programmed into the memory of your telephone. Each memory location can store a maximum of 32 digits.

### ► STORING ONE-TOUCH SPEED DIAL NUMBERS

Eg: To program UNIDEN telephone number, 0295993577 into speed dial location 3

1. Press the store button (Display shows NUMBER ?).
2. Enter the phone number 0 2 9 5 9 9 3 5 7 7 using the keypad
3. Press the store button (Display shows NAME ?)
4. \*Enter the name U N I D E N using the keypad  
(88 66 444 3 >> 33 66)
5. Press the store button (display shows STORE TO?)
6. Press the **speed dial** button number 3

The phone will beep and the display will show STORED

\* If you do not want to store a name, skip step 4



! If you have to type in several letters (consecutively) contained in one button (i.e. D & E), you need to press >> to move the cursor to the next space prior to pressing the button again.

! To add a space before another word, press 1 once. For more than one space, press >>. Repeated pressing of the keypad digit '1' will step through the following symbols: - ' ( ) &

! Repeated pressing of any other keypad digit will step through the letters and number associated with that key

Examples A=2, B=22, C=222, 2=2222, D=3, E=33, F=333 3=3333



! Repeated pressing of the << or >> button will move the cursor backwards or forwards to the position required.

! When the cursor is flashing on top of any character you can press the delete button to delete that character

! Always store area code together with telephone numbers. This will be useful for CID purposes.

### ► PAUSE

During the memory storage procedure, you may wish to press the rdl/p button to insert a pause between numbers. (This is sometimes useful for accessing a switch board, telephone banking or long distance dialling).

Pressing rdl/p button more than once will increase the pause between digits.

Each time the rdl/p button is pressed, a 'P' will show on the LCD to indicate a 2 second pause in the dialing sequence. Each pause counts as one digit.

### ► MEMORY STORAGE CARD

When you have programmed a number into the speed dial memory, you can write the name of the person on the memory storage card (supplied).

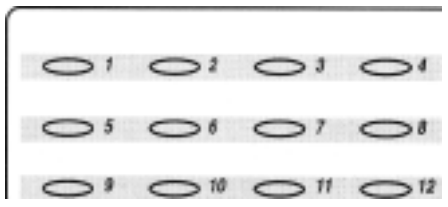

### ► DIALING THE STORED NUMBERS

There are four different ways to dial a stored speed dial number, depending on your preference.

1. Pick up the handset and press the desired **memory** button (1 - 12).
2. Press the **speaker** button and then press the desired **memory** button (1 - 12).
3. Press the desired memory button (1 - 12), and check the LCD shows the correct information. Press the **dial** button (the phone enters speakerphone mode and dials the displayed number).
4. Press the desired **memory** button (1 - 12), and check the LCD shows the correct information. Pick up the handset and then press the **dial** button.



! If you have selected a speed dial button that does not have a stored number, the telephone will not dial. For options 3 & 4, the LCD will show <EMPTY> if there is no number stored in the memory button pressed.

### ► CHAIN DIALING

On certain occasions (such as telephone banking), after dialing one number, you may wish to dial another number without hanging up. This is known as chain dialing or cascade dialing. Simply store the second number in another memory location and press the corresponding speed dial button when required. In this way you can recall both numbers that are stored into their own memory locations at the relevant times.

### ► CALLTIMER

Approximately 10 seconds after the handset is picked up, or the speaker button is pressed, the call counter will begin and show the elapsed time on the display screen.



### LCD BACKLIGHT DISPLAY

The LCD has a back light that will turn on under the following conditions;

- ! Any incoming call
- ! Picking up the handset
- ! Pressing any button

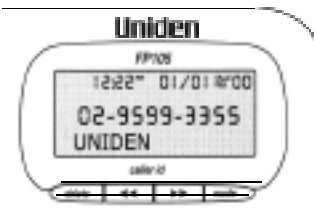

! The backlight will switch off automatically approximately 15 seconds after the last activity. The AC Adaptor must be plugged into the unit to enable BACK LIGHT to work.

### ► EDITING A STORED ONE-TOUCH SPEED DIAL MEMORY

1. Press the store button then the **speed dial memory** (1-12) you want to edit
2. Move the cursor to the number you would like to **edit** by using >>
3. Press **delete** then key-in the desired number using the keypad
4. Press store (Display shows NAME?)
5. Move the cursor to the letter to be edited using >>
6. Press **delete** then key-in the desired letter using the keypad
7. Press store (Display shows STORE TO?)
- a. Press **speed dial memory** locations (1-12) to store edited information. The phone will beep & the display will show STORED.



### ► DELETING ONE SPEED DIAL MEMORY

1. Press the **speed dial** button (1-12)  
(Display shows contents of this memory)
2. Press the **delete** button (Display shows DELETE 1-12 ?)
3. Press the **delete** button again
4. The phone beeps and the display shows DELETED.

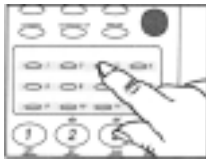

### ► DELETING ALL SPEED DIAL MEMORIES

1. Press and hold the store button for 2 seconds to enter the Options Menu (Display shows LCD CONTRAST)
2. Press the store button 4 times (Display shows RESET PP CODES)
3. Press the >> or << buttons to choose CLEAR SPEED DIAL
4. Press the store button to confirm your choice and exit the Options Menu.



## USING THE PRE PROGRAMMED FEATURE BUTTONS

Easy access to some of Telstra's most popular network service features have been factory programmed into this telephone for your convenience.



*Some of the Telstra network services that will be described here are subscription or user pays services. These services may not be available to all customers in a// areas. To subscribe to any of these services, or check on the availability for you in your area, please contact Telstra Residential Sales and Service on '13 2200' or Telstra Business on '13 2000'.*

### ► ACCESSING THE CALL WAITING SERVICE USING THE *call waiting* BUTTON

1. While talking, you hear the call waiting signal (series of beep tones).  icon appears on the display.
2. Press the **call waiting** button to switch call and put the current call on hold.
3. To switch back to original call, press the **call waiting** button.



### ► ACCESSING THE CALL WAITING SERVICE USING THE *flash* BUTTON

1. While talking, you hear the call waiting signal (series of beep tones).  icon appears on the display.
2. Press the **flash** button then 2 to switch call and put the current call on hold.
3. To switch back to original call, press the **flash** button then 1.



*The flash + 2 call waiting procedure toggles call between the incoming and the original call (vice versa). The flash + 1 procedure will drop the current call connection and pick up the incoming call or the call on ho/d,*

### ► *transmit C/D*

If your number is listed as silent, your telephone number will not be forwarded to the party you are calling. In certain cases, such as calling friends or relatives, follow these steps if you wish your number to be forwarded.

1. Pick up the handset or press the **speaker** button.  
Wait for the dial tone.
2. Press the **transmit C/D** button
3. Dial the telephone number of the person you wish to call.  
Your telephone number will be forwarded for this call only.

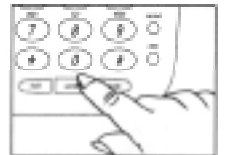

Telstra is a registered trademark of Telstra Corporation Limited ACN 051 775 556

### ► **block CID**

Each time you make a call, your telephone number is automatically forwarded to the party you are calling (unless your number is a silent number). In certain cases you may wish to prevent your number being sent, follow these, steps.

1. Pick up the handset or press the **speaker** button.  
Wait for the dial tone,
2. Press the **block C/D** button
3. Dial the telephone number of the person you wish to call.  
Your telephone number will be withheld for this call only.

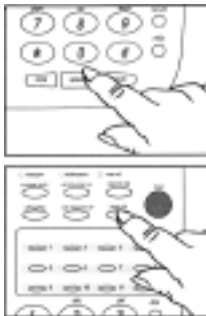

### ► **call diversion on**

Telstra's 'Call Forward No Answer' Service is available for diverting calls to another number if your phone is not answered within 20 seconds (approximately 7 or 8 rings).

1. Pick up the handset or press the **speaker** button.
2. Wait for the dial tone, press the call **diversion on** button and then hang up. The telephone will automatically dial the access code \*61# and will enable 'Call Forward No Answer' feature thus, diverting unanswered calls to the fixed number you have previously assigned the divert to.

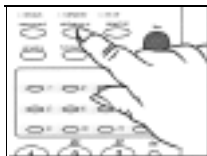

### ► TO PROGRAM/RE-PROGRAM THE FIXED "CALL FORWARD....." NUMBER

Follow the example below, replacing the number **9876 5432** with the number you wish to divert calls to.

#### Example

1. Pick up the handset or press the **speaker** button. Wait for the dial tone.
2. Press \*6 19 8 7 6 5 4 3 2 # on the keypad. You will hear a long beep and a voice announcement confirming that this feature has been activated.
3. Hang up.

To confirm the diverted number;

1. Turn 'Call Waiting' off  
(Pick up the handset, wait for dial tone, press #4 3#, wait for confirmation tone then hang up)
2. Dial your own number.

The number you are forwarding your calls to will begin to ring.  
The normal Local, Mobile or National Call charges will apply.

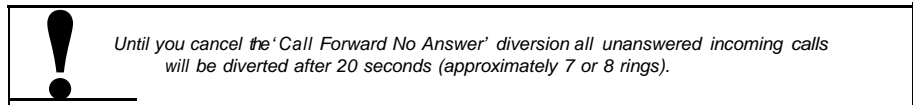

### I call diversion off

To cancel 'Call Forward No Answer' to another number.

1. Pick up the handset or press the **speaker** button.
2. Press the **call diversion off** button and then hang up.  
The telephone will automatically dial the access code #61# and will cancel the diversion.

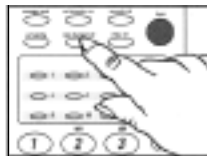

### I **message bank**

'Message Bank' is Telstra's "invisible answering machine". When your line is busy, or you are not able to answer your phone 'Message Bank' to play callers, your own personal greeting and be prompted to leave a message.

You can tell if you have a message in your 'Message Bank' because the **message** LED will be flashing on your telephone and the vmwi **envelope** icon will be shown on the display.

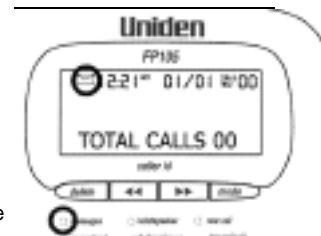

If the **message** LED is flashing, press the **message bank** button then the **dial** button. The phone will enter the speaker phone mode and dial the Sydney FREECALL Message Bank number 1800 351 244. When prompted, enter your PIN number followed by the '#' key. Once you reach the main menu press '1' to listen to your messages.

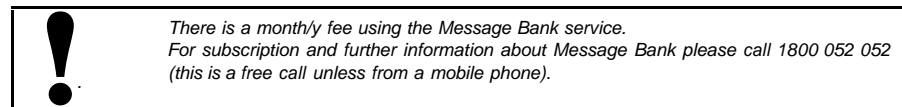

Adelaide : 1 800 351 844

1. Press the store button
2. Press the **message bank** button
3. Press the >> button 7 times
4. Press the keypad 8 button
5. Press the **delete** button
6. Press the store button 2 times
7. Press the **message bank** button

Brisbane : 1 800 351 744

1. Press the store button
2. Press the **message bank** button
3. Press the >> button 7 times
4. Press the keypad 7 button
5. Press the **delete** button
6. Press the store button 2 times
7. Press the **message bank** button

Melbourne : 1 800 351 344

1. Press the store button
2. Press the **message bank** button
3. Press the >> button 7 times
4. Press the keypad 3 button
5. Press the **delete** button
6. Press the **store** button 2 times
7. Press the **message bank** button

Perth : 1 800 351 944

1. Press the store button
2. Press the **message bank** button
3. Press the >> button 7 times
4. Press the keypad 9 button
5. Press the **delete** button
6. Press the store button 2 times
7. Press the **message bank** button

## USING CALLER ID

To make use of these features, you must first subscribe to Telstra's Caller ID Service. There is usually a fee for this service, and may not be available in all areas.

### ► 33 MEMORY CALLER ID

When you use this telephone with the Caller ID service, you will see the number of the calling party (unless the call is blocked or is from a silent number) before you answer the phone. This telephone will store and display information about the last 33 calls received. Each call is numbered in the call history, together with the time and date the call was received. When the memory is full, the oldest call information is deleted to make room for new incoming call information.

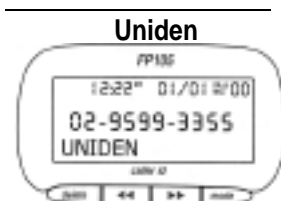

### ► CALLER ID ON CALL WAITING

This feature allows you to see the number of the calling party (unless the call is blocked or is from a silent number) while you are on call. However, you must first subscribe to Telstra's Caller ID Service and activate your call waiting service.



To pick up the call follow steps in ACCESSING CALL WAITING on page 18. Caller ID on call waiting may not be available in all areas.



If you do not subscribe to the Caller ID Service, we recommend you set the Caller ID on Call Waiting to OFF.

### ► NEW CALL NOTIFICATION

When a new call is received, the time, date and calling number will be displayed between the first and second ring.

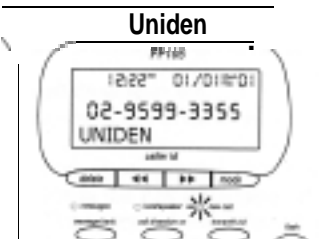
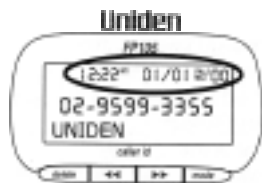

The new *call* LED will flash quickly when the phone is ringing, and then change to a slow flash. It will continue to flash until all new call information in the call history has been reviewed.

### ► NEW CALL REVIEW

To review only new call information;

1. Press the mode button, and the display will show REVIEW NEW CALL.
2. Use the << or >> buttons to view the new calls. When the display shows END OF LIST or TOP OF LIST When all new calls have been reviewed, the new call LED will stop flashing.

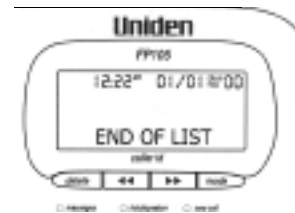

### ► CALLER ID SUMMARY

The display will show the caller ID summary TOTAL CALLS XX (where XX is the total number of calls stored in the memory)



The display may also show the number of new calls received. (New calls means calls that have not been reviewed yet)

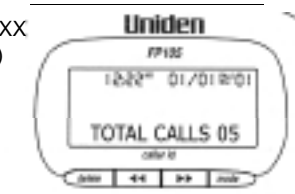

### ► CALL REVIEW

To review all the calls in the call history, use the << or >> buttons.

When the display shows END OF LIST or TOP OF LIST, all calls have been reviewed.

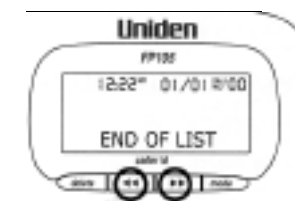

If the caller id number is longer than 76 digits, you can press the keypad digit 3 to view the next digit to the right. Press the keypad digit 1 to view the next digit to the left. The phone will beep 4 times in quick succession when the end of the number has been reached.

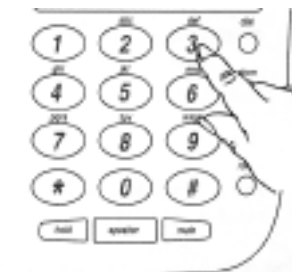

### ► DELETING A CALL FROM THE CALL HISTORY

To delete a call from the call history;

1. Use the << or >> buttons until the screen displays the information you wish to delete.
2. Press the **delete** button once and the display will show DELETE ?
3. Press the **delete** button again.

The phone will beep once, the displayed call record will be deleted and the display will show DELETED.

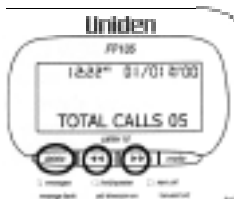

### ► DELETING ALL CALLS FROM THE CALL HISTORY

To delete all calls from the call history, the display must be showing the call summary TOTAL CALLS XX.

1. Press the **delete** button once and the display will show DEL ALL CID ?
2. Press the **delete** button again.

The phone will beep once, all call records will be deleted and the display will show DELETED.

**!** *New calls can not be deleted until they have been reviewed.  
All information deleted cannot be retrieved.*

### ► SPEED DIALING FROM THE CALLER ID LIST

1. Use the << or >> buttons to scroll through the call history.
2. When you locate the number you wish to call, press the **dial** button. The telephone will enter the speaker phone mode and dial the displayed number.  
Pick up the handset at any time.

### ► TRANSFERING A CALLER ID NUMBER TO THE SPEED DIAL MEMORY

1. Use the << or >> buttons to scroll through the call history.
2. When you locate the number you wish to transfer, press the **store** button. The display will show STORE TO ?
3. Press a **speed dial** memory button (1 - 12) to store the number into the one-touch speed dial list.



The phone will beep once, and the display will show STORED.

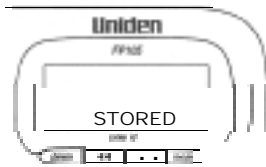

### ► TO STORE A NAME AGAINST A STORED PHONE NUMBER

1. Press the **store** button. The display will show NUMBER?
2. Press the **speed dial** memory button (1-12) where you stored the phone number.
3. Press **store** again. The display will show NAME?
4. Enter the desired name using the alphanumeric keys.
5. Press **store** again. The display will show STORE TO?
6. Press the **speed dial** memory button (1-12) where you stored the phone number.

## DISPLAY INFORMATION

### ► CALL DISPLAY MESSAGES

**PRIVATE** on the screen means;

- The caller has chosen to block their number
- A call from an old type of telephone network exchange
- A call from a silent number subscriber
- A call from any analogue cellular mobile telephone



**UNAVAILABLE** on the screen means;

- A call coming from overseas



**PAYPHONE** on the screen means;

- A call originating from a payphone



**ERROR** on the screen means;

- There has been an Error during the transmission of Caller ID information. This does not mean your phone is faulty.



**END OF LIST** or **TOP OF LIST** on the screen means;

- You have reached the end or start of the caller id history information.



**TOTAL CALLS 00** on the screen means;

- You have not received any caller id information
- No calls are stored in the caller id history



### ► MESSAGE BANK INDICATORS

If you subscribe to Telstra's Message Bank Service, and a new message has been left, the **message** LED on your phone will begin to flash and the VMW/envelope icon will show on the display. When you have cleared the message the **message** LED and envelope icon will turn off.



**!** *There may be a delay in these indicators turning on or off.  
In certain circumstances, your phone may already been in use, resulting in a delay until the VMWI message is re-sent.*

► **VIP**

- You can transfer any Caller ID record into the VIP Call List and gain these special features:
- 1. The telephone will sound a special VIP tone (3 different VIP tones are available) to alert you to an incoming VIP call.
  - 1. You can speed dial from the VIP Call list.

► **VIP ALERT ON/OFF**

1. Press and hold the **store** button until display shows LCD CONTRAST.
2. Press the **store** button twice, display shows VIP ALERT ON.
3. Press the >> or << buttons to choose VIP ALERT ON/OFF
4. Press the **store** button to set and move to the next menu option or **cancel** to exit.

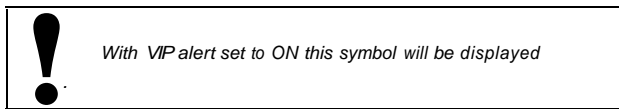

► **SETTING A VIP CALL**

1. Use the << or >> buttons to scroll through the call history.
2. When you locate the number you wish to transfer, press the mode button. The display will show SET AS VIP ?
3. Press the mode button again. The display will show RING TYPE : 1
4. Press the mode button to accept VIP ring type 1 or press the >> button to select a different ring type (press mode after selecting ring type). The phone will beep once, and the display will show STORED.

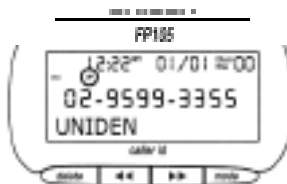
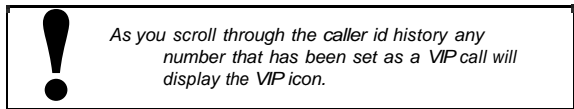

► **REVIEWING VIP CALLS**

- To review only VIP call information:
1. Press the mode button twice, and the display will show REVIEW VIP CALL.
  2. Use the << or >> buttons to view the VIP calls.

► **SPEED DIALING FROM THE VIP LIST**

1. Press the mode button twice and the display will show REVIEW VIP CALL
2. Use the << or >> buttons to scroll through the VIP list until you locate the number you wish to call.
3. Press the **dial** button. The telephone will enter the speaker phone mode and dial the displayed number. Pick up the handset at any time.

► **RESETTING A VIP CALL**

1. Press the mode button twice, and the display will show REVIEW VIP CALL. Use the << or >> buttons to view the VIP calls.
2. When you locate the VIP number you wish to reset to normal, press the mode button. The display will show SET AS NORMAL ?
3. Press the **mode** button again. The phone will beep once, and the display will show STORED.

► **DELETING A VIP CALL**

- To delete a VIP call;
1. Press the mode button twice and the display will show REVIEW VIP CALL?
  2. Use the << or >> buttons until the screen displays the information of the VIP call you wish to delete.
  3. Press the delete button once and the display will show DELETE ?
  4. Press the **delete** button again. The phone will beep once, the displayed call record will be deleted and the display will show DELETED.

► **NAME TAGGING**

When the phone number of an incoming call is matched with the exact number stored in one of the 12 one-touch speed dial memory locations, the name stored in the memory will automatically be displayed together with the caller id number.

This is useful because currently Telstra do not forward the calling party name. It is also useful because the name stored in the speed dial memory can be personalised to suit your particular situation.

**Example**

If the number '02 9599 3577' and the name 'UNIDEN' is stored into one of the speed dial memory locations (1 -12) and the caller id number '02 9599 3577' is sent by the Caller ID network, the name 'UNIDEN' will be automatically displayed together with the phone number, time and date of the call.

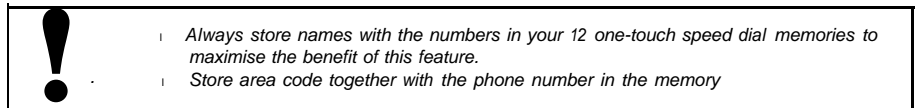
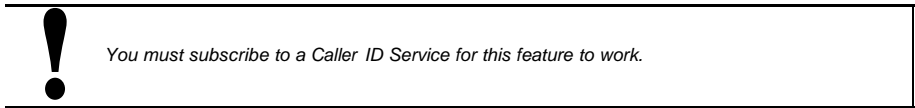

► **LCD CONTRAST**

1. Press and hold the store button for approximately 2 seconds until the display shows LCD CONTRAST.
2. Press the >> or << buttons to adjust the display contrast to the desired viewing level.
3. Press the store button to set and move to the next menu option or **cancel** to save and exit.

► **TIME/DATE**

1. Press and hold the store button until the display shows LCD CONTRAST.
2. Press the store button again, and the display will show SET TIME/DATE.
3. Press \*(am) OR #(pm).
4. Use the keypad buttons to set the time and date manually following the cursor position.  
Press the store button to set and move to the next menu option or **cancel** to save and exit.

**Example**

To set the time and date as : 08.45AM on the 9th of July

1. Use the keypad buttons and press \* 0 8 4 5 8 9 0 7
2. Press the **store** button to set and move to the next menu option or **cancel** to exit,



*If you make a mistake, use the << or >> buttons to move the cursor and re-enter the correct information.  
If you subscribe to a Caller ID service, the time and date will be automatically updated when the first C/D information is received, therefore you do not need to set it manually.*

► **CALL WAIT ID ON/OFF**

1. Press and hold the store button until display shows LCD CONTRAST
2. Press the store button 3 times until the display shows CALL WAIT ID ON,
3. Press the >> or << buttons to choose CALL WAIT ON/OFF
4. Press the store button to set and move to the next menu option or **cancel** to save and exit.

► **RESET PP CODE I CLEAR SPEED DIAL I NO CHANGES**

1. Press and hold the store button until display shows LCD CONTRAST.
2. Press the store button 4 times until the display shows RESET PP CODE.
3. Press the >> or << buttons to choose from the following options;  
RESET PP CODE (Resets all pre-programmed codes to factory default),  
CLEAR SPEED DIAL (Deletes all stored Speed Dial memories),  
NO CHANGES
4. Press the store button to confirm your choice and exit the Options Menu.



*The Advance User Options Menu can not be accessed if the handset is off the cradle or if the telephone is in the speaker phone mode.  
To exit the Advance User Options Menu at any time, press the **cancel** button.*

TROUBLESHOOTING YOUR PHONE

**TROUBLESHOOTING**

If your Telephone is not performing to your expectations, please try these simple steps. If you are still unable to resolve the problems, contact Uniden Customer Service for assistance.

Problem	Suggestion
Can't make or receive calls.	<ul style="list-style-type: none"> <li>Make sure you use only the line cord supplied with this telephone.</li> <li>Check that both ends of the telephone line cord and Handset cord are plugged in.</li> </ul>
Can't hear the telephone ringing.	<ul style="list-style-type: none"> <li>Make sure you do not have too many telephones connected to the telephone line.</li> <li>Adjust the Ringer Volume to either lo/hi.</li> <li>Plug another telephone into the telephone socket and check for a dial tone.</li> </ul>
Speakerphone Volume too low.	<ul style="list-style-type: none"> <li>During speakerphone conversation, adjust the speakervolume slider control on the side of the telephone.</li> </ul>
One Touch Speed Dial Numbers are not working correctly.	<ul style="list-style-type: none"> <li>Repeat the memory storage procedures detailed on page 15.</li> </ul>
Handset does not hang up in the wall mount position.	<ul style="list-style-type: none"> <li>Make sure the Handset Retainer Tab has been turned around (point facing up) and the Handset is placed firmly into the cradle.</li> </ul>
New Call LED keeps flashing	<ul style="list-style-type: none"> <li>All new calls must be reviewed before the new call LED stops flashing.</li> </ul>
Message LED keeps flashing.	<ul style="list-style-type: none"> <li>Review and clear message bank messages.</li> </ul>
Caller ID feature not working Message Bank feature not working Call Diversion feature not working	<ul style="list-style-type: none"> <li>These are all subscription or user pays services. To subscribe, or check the pricing and availability, please contact Telstra Residential Sales and Service on '13 2200 or Telstra Business on '1 3 2000</li> </ul>
Display information is incomplete or frozen.	<ul style="list-style-type: none"> <li>This can happen due to power interruption. Reset your phone by pushing the reset button (tiny switch located at the rear side of the base).</li> </ul>

Telstra is a registered trademark of Telstra Corporation Limited ACN 051 775 556

## SPECIFICATIONS

Model	FP105
Compliance	TS001 , TS002,TS004, <del>TS008</del> AS31 08, AS3548
Size:	165mm(W) x 115mm(D) x 80mm(H)
Weight:	Approx. 880gm (including back up battery)
AC Adaptor	Input: 240V AC 50Hz Output: 9V AC 500mA Approval Number : V95252
Battery back up	9V Alkaline (not re-chargeable)

Specifications, Features and availability of Optional Accessories shown are typical and subject to change without notice.

## WARRANTY

One-Year Limited Warranty

Important: Evidence of original purchase is required for warranty service.

WARRANTOR: Uniden Australia Pty Limited ACN 001 865 498

**ELEMENTS OF WARRANTY** Uniden warrants to the original retail owner for the duration of this warranty its FP105 (hereinafter referred to as the Product), to be free from defects in materials and craftsmanship with only the limitations or exclusions set out below.

**WARRANTY DURATION:** This warranty to the original retail owner only, shall be of no further effect 12 months after the date of original retail sale. This warranty will be deemed invalid if the product is: (A) Damaged or not maintained as reasonable and necessary, (B) Modified, altered or used as part of any conversion kits, subassemblies, or any configurations not sold by Uniden, (C) Improperly installed, (D) Repaired by someone other than an authorised Uniden Repair Agent for a defect or malfunction covered by this warranty, (E) Used in conjunction with any equipment or parts or as a part of a system not manufactured by Uniden.

**PARTS COVERED:** This warranty covers for one (1) year, the Telephone and Handset only. All accessories (Cable and Modular Plug) are covered for 90 days only.

**STATEMENT OF REMEDY** In the event that the product does not conform to this warranty at any time while this warranty is in effect, the warrantor, at its discretion, will repair the defect or replace the product and return it to you without charge for parts and service. **THIS WARRANTY DOES NOT COVER OR PROVIDE FOR THE REIMBURSEMENT OR PAYMENT OF INCIDENTAL OR CONSEQUENTIAL DAMAGES. THIS GUARANTEE IS IN ADDITION TO AND DOES NOT IN ANY WAY AFFECT YOUR RIGHTS UNDER THE CONSUMER ACT.**

**WARRANTY CARD:** If a Warranty Card has been included with this Product, please complete and return to us within 14 days of purchase. Your name and the serial number of the Product will then be registered in our database and this will help us process your claim with greater speed and efficiency should you require warranty service.

**PROCEDURE FOR OBTAINING PERFORMANCE OF WARRANTY** In the event that the product does not conform to this warranty, the Product should be shipped or delivered, freight pre-paid, with evidence of original purchase (e.g. a copy of the sales docket) to the warrantor at:

UNIDEN AUSTRALIA PTY LIMITED  
SERVICE DIVISION  
345 Princes Highway, Rockdale, NSW 2216  
Ph: (02) 9599 3577 Fax: (02) 9599 3278  
TOLL FREE 1 300 366 895

Customers in other States should ship or deliver the Product freight pre-paid to their nearest Uniden Authorised Repair Centre. (Contact Uniden for the nearest Warranty Agent to you)



## Free Manuals Download Website

<http://myh66.com>

<http://usermanuals.us>

<http://www.somanuals.com>

<http://www.4manuals.cc>

<http://www.manual-lib.com>

<http://www.404manual.com>

<http://www.luxmanual.com>

<http://aubethermostatmanual.com>

Golf course search by state

<http://golfingnear.com>

Email search by domain

<http://emailbydomain.com>

Auto manuals search

<http://auto.somanuals.com>

TV manuals search

<http://tv.somanuals.com>