

Uniden®

WDSS 5315
WDSS 5315+1
Series Owner's Manual

OWNER'S MANUAL

Table of Contents

| | | | |
|---|-----------|--|-----------|
| Welcome | 4 | Name Tag..... | 19 |
| Terminology Used in this Manual..... | 5 | Insert 0..... | 19 |
| Manual Conventions..... | 5 | Setting up Voice Mail | 20 |
| Product Overview | 6 | Programming One-Touch Voice Mail Access..... | 20 |
| Features..... | 6 | Resetting the Voice Message Waiting Indicator..... | 20 |
| Parts of the Phone..... | 7 | Adding Accessory Handsets | 21 |
| Using the Interface | 9 | Compatible Handsets..... | 21 |
| Reading the Display..... | 9 | Charging Accessory Handsets..... | 21 |
| Using the Four-way Function Key..... | 10 | Registering WDSS 5305 Accessory Handsets..... | 22 |
| Using the Handset Menus..... | 10 | Resetting Handsets..... | 23 |
| Entering Text from Your Handset..... | 11 | Setting Up the Phonebook | 24 |
| Installing the Phone | 12 | Creating Phonebook Entries..... | 24 |
| Choosing the Best Location..... | 12 | Finding a Phonebook Entry..... | 25 |
| Wall Mounting the Base..... | 13 | Editing an Existing Phonebook Entry..... | 25 |
| Direct Wall Mounting..... | 14 | Storing Caller ID or Redial Numbers in the Phonebook..... | 26 |
| Installing the Battery..... | 15 | Deleting Phonebook Entries..... | 26 |
| Connecting the Base and Charging the Handset .. | 16 | Copying Phonebook Entries to Another Handset .. | 27 |
| Installing the Belt Clip..... | 16 | | |
| Connecting to the Phone Line..... | 17 | | |
| Testing the Connection..... | 17 | | |
| Basic Setup | 18 | | |
| Activating Personal (Distinctive) Ring..... | 18 | | |
| Activating the Key Touch Tone..... | 18 | | |

| | | | |
|--|-----------|---|-----------|
| Customizing Your Phone | 28 | Using Conference and Transfer | 37 |
| Selecting a Ring Tone (Handset only)..... | 28 | Conferencing | 37 |
| Activating AutoTalk (Handset only) | 29 | Transferring a Call | 37 |
| Activating Any Key Answer (Handset only)..... | 29 | Answering a Transferred Call | 37 |
| Activating Clarity Boost for All Calls (Handset Only) ... | 29 | Using Special Features | 38 |
| Using Your Phone..... | 30 | Muting the Ringer (One call only) | 38 |
| Making a Call from the Phonebook..... | 31 | Muting the Microphone | 38 |
| Chain Dialing from the Phonebook | 31 | Privacy Mode | 38 |
| Switching to the Handset Speakerphone | | Using the Intercom..... | 39 |
| During a Call | 31 | Installing the Optional Headset..... | 40 |
| Using Caller ID, Call Waiting, and Redial Lists | 32 | Maintenance | 41 |
| Using the Caller ID List | 32 | Specifications..... | 41 |
| Making a Call from a Caller ID Record | 32 | Battery Replacement and Handling | 42 |
| Deleting Caller ID Numbers | 33 | Cleaning the Battery Contacts | 42 |
| Using Call Waiting..... | 33 | Low Battery Alert | 43 |
| Redialing a Number | 34 | Talk and Standby Times..... | 43 |
| Deleting a Redial Record..... | 34 | Troubleshooting | 44 |
| Adjusting the Ringer, Earpiece and Speaker Volume .. | 35 | Resetting the Handset | 44 |
| Adjusting the Ringer Volume | 35 | Resetting the Handset Without the Base..... | 45 |
| Adjusting the Earpiece Volume | 35 | Changing the Digital Security Code..... | 45 |
| Adjusting the Speaker Volume..... | 35 | Traveling Out of Range..... | 45 |
| Adjusting the Audio Tone | 36 | Common Issues | 46 |
| Using the Clarity Boost Feature | 36 | Liquid Damage..... | 48 |
| Finding a Lost Handset..... | 36 | | |

| | |
|---|-----------|
| Precautions! | 49 |
| Rechargeable Nickel-Metal-Hydride Battery Warning ... | 49 |
| Index | 50 |
| One Year Limited Warranty..... | 54 |



Welcome

Thank you for purchasing a Uniden Multi-Handset phone.

Note: Illustrations in this manual are used for explanation purposes. Some illustrations in this manual may differ from the actual unit.



Terminology Used in this Manual

| | |
|---------------------------|--|
| Standby | The handset is not in use. If the handset is on the cradle or [flash] or [MUTE] on the handset is not pressed, no line has been activated. No dial tone is present. |
| CID | Caller ID is available from your Telephone provider and is offered to users on a subscription basis. With this service and a display on your cordless phone, you will be able to see the incoming caller information such as name and phone number. |
| CID/CW or CIDCW | Caller ID with Call Waiting is available by subscription from your Telephone provider. With this service, you will be able to view incoming caller information while on a call with another user. This will allow you the ability to select to talk to this user and put your existing party on hold or make the decision to ring them back. |
| Base | The main part of the phone that connects to your phone line and lets you make and receive calls. |
| Charger | A cradle that comes with an accessory handset and charges the handset battery. It connects to power but does not connect to a phone line. |
| Accessory Handsets | This phone system is expandable and will support a total of eight (8) handsets to one base. The WDSS 5305 accessory handset is compatible with this model. |
| Global settings | Global Settings apply to all registered handsets. If you change something under the global menu, you change it for all handsets. Only one handset can change global settings at a time, and you have to make sure the phone is not currently being used. |
| Talk | A telephone line has been activated on the handset or base, enabling a dial tone. |

Manual Conventions

This manual uses several different type styles to help you distinguish between different parts of the phone:

- **lower case bold** text with “[]” indicates a key or button on the phone
- ALL CAPITALS indicates text on the display, such as menu options, prompts, and confirmation messages
- **lower case bold** text indicates a status light on the phone base

Product Overview

Features:

- 5.8GHz Wide Band Digital Technology Expandable System
- Expands up to 8 Handsets
- Caller ID*
 - Caller ID on Call Waiting
 - Name Tag (Pop ID)
 - Personal (Distinctive) Ring
- Store 30 Caller ID Numbers
- Advanced Phonebook Features
 - Store 70 Phonebook Entries
 - Alphabetical Search
 - Personalized Ring by Party
 - Transfer Single Listing or Entire Phonebook
- Speakerphone on Handset
- 7 Ringer Options on Handset (3 Tones/4 Melodies)
- Last 5 Number Redial
- Call Transfer
- Conferencing
- Intercom

* Caller ID, Name Tag, Distinctive Ring features require subscription to the Caller Display service from your network supplier. A fee normally applies for this. The Caller ID on Call Waiting service is currently unavailable in New Zealand.

Parts of the Phone

The following illustrations show you all of the different parts of your phone.

Handset

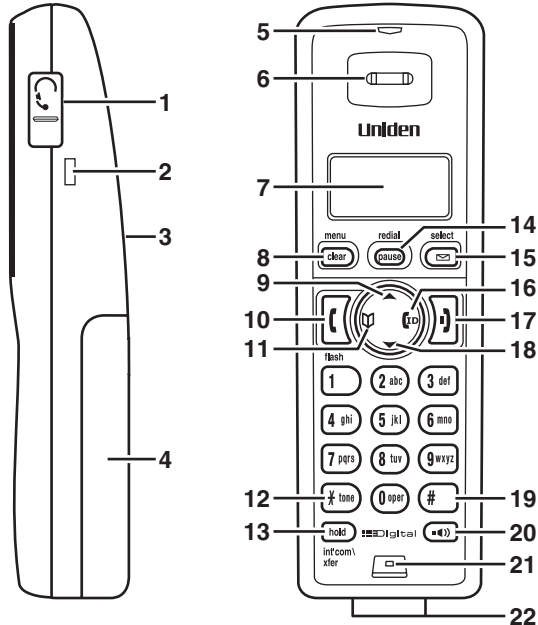

1. Headset Jack Cover
2. Belt clip Hole
3. Speakerphone Speaker and Ringer
4. Handset Battery Compartment
5. New Message LED
6. Handset Earpiece
7. LCD Display
8. **[menu/clear]** key
9. **[▲]** key (up)
10. **[/flash]** key (talk/flash)
11. **[📖]** key (phonebook/left)
12. **[*/tone]** key
13. **[hold/int'com/xfer]** key
14. **[redial/pause]** key
15. **[select/✉]** key (select/messages)
16. **[📞]** key (caller ID/right)
17. **[⏏]** key (end call)
18. **[▼]** key (down)
19. **[#]** key
20. **[🔊]** key (speaker)
21. Handset Microphone
22. Handset Charging Contacts

Base

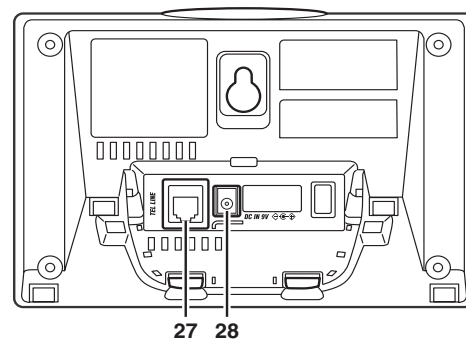
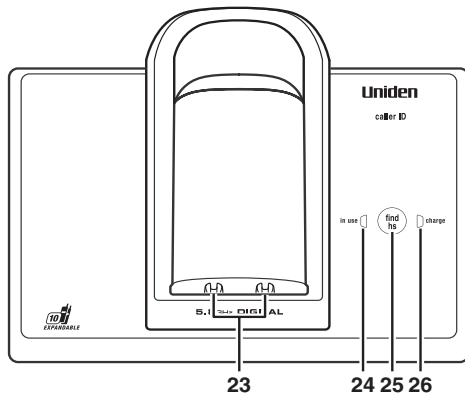







- 23. Base charging contacts
- 24. in use LED
- 25. **[find hs]** key (find handset)
- 26. charge LED

- 27. TEL LINE Jack
- 28. DC IN 9V Jack

Using the Interface

Reading the Display

The handset display uses icons to tell you the status of your phone. The table below lists the icons and what they mean.

| Icon | Status | Description |
|---|--------------|---|
|  | Standby/Talk | The battery icon indicates the handset battery status: full, medium, low, and empty. |
|  | Standby | The ringer off icon indicates that the ringer is turned off. |
|  | Talk | The mute icon appears while the handset microphone is muted. |
|  | Talk | The boost icon appears when the Clarity Boost feature is activated. |
|  | Talk | The speaker icon appears when the handset speaker phone is in use. |
|  | Talk | The privacy icon appears when the Privacy Mode is turned on. |

The Standby Screen

When the phone is in standby, the handset display shows the following items:

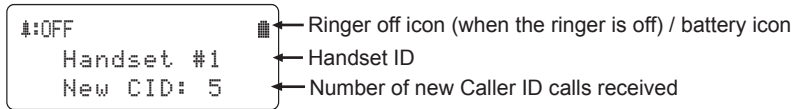

Using the Four-way Function Key

Your handset has a four-way function key that allows you to move the cursor or pointer on the display and access the most commonly used features at the touch of a button. By moving this key to the left, you open the phonebook. Move the key to the right to access Caller ID information. To use this four-way key, place your thumb over the key on the handset and move to the four positions to get the feel of how it moves and operates.

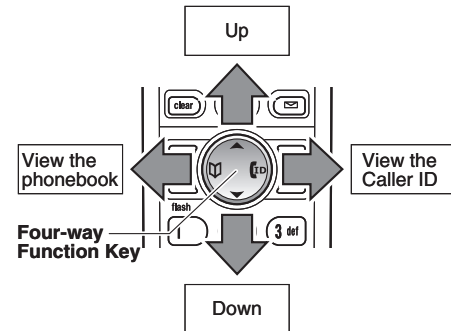

Using the Handset Menus

To open the menu, press **[menu/clear]**. Select the option you want by pressing the four-way function key. This will move the cursor; the option currently selected has a triangle beside it. Activate the selected option by pressing **[select/Ⓜ]**. To exit the menu and return to standby, press **[*]**.

If you do not press a key within 30 seconds, the phone will time out and exit the menu.

Entering Text from Your Handset

You can use the number keypad on your handset to enter text by referring to the letters printed on each number key. When you press the number key in a text entry field, the phone displays the first letter printed on the number key. Press the number key twice to display the second letter and three times to display the third. Capital letters are displayed first, then lower case letters, then the number on the key.

If two letters in a row use the same number key, enter the first letter, then use **[right]** or **[left]** on the four-way function key to move the cursor to the next position to enter the second letter. For example, to enter the word "Movies":

- 1) Press **[6]** once to enter *M*.
- 2) Use **[right]** on the four-way function key to move the cursor to the right.
- 3) Press **[6]** six times to enter *o*.
- 4) Press **[8]** six times to enter *v*.
- 5) Press **[4]** six times to enter *i*.
- 6) Press **[3]** five times to enter *e*.
- 7) Press **[7]** eight times to enter *s*.
- 8) Press **[select/✉]** to end your text entry.

| keys | Number of times key is pressed | | | | | | | | |
|--------|--------------------------------|---|---|---|---|---|---------|----|----|
| | 1 | 2 | 3 | 4 | 5 | 6 | 7 | 8 | 9 |
| 1 | 1 | | | | | | | | |
| 2 abc | A | B | C | a | b | c | 2 | | |
| 3 def | D | E | F | d | e | f | 3 | | |
| 4 ghi | G | H | I | g | h | i | 4 | | |
| 5 jkl | J | K | L | j | k | l | 5 | | |
| 6 mno | M | N | O | m | n | o | 6 | | |
| 7 pqrs | P | Q | R | S | p | q | r | s | 7 |
| 8 tuv | T | U | V | t | u | v | 8 | | |
| 9 wxyz | W | X | Y | Z | w | x | y | z | 9 |
| 0 oper | & | < | > | < | > | / | (blank) | -- | -- |
| | . | , | : | ? | ! | @ | ' | " | * |
| | # | 0 | | | | | | | |

If you make a mistake while entering a name, use **[right]** or **[left]** on the four-way function key to move the cursor to the incorrect character. Press **[menu/clear]** to erase the wrong character, and then enter the correct character. To delete all characters, press and hold **[menu/clear]**.

Installing the Phone

Choosing the Best Location

When choosing a location for your new phone, here are some important guidelines you should consider:

- The location should be close to both a phone jack and a continuous power outlet (one which is not connected to a switch).
- The base and handset should be kept away from sources of electrical noise such as motors, microwave ovens, and fluorescent lighting.
- For better reception, place the base as high as possible.
- The base should be placed in an open area for optimum range and reception.
- If your home has wired alarm equipment connected to a phone line, be sure that installing the system does not disable your alarm equipment. If you have questions about what will disable alarm equipment, contact your telephone company or a qualified installer.

Note: For maximum range:

- Keep the antenna free of obstruction.
- When the handset is not in use, place the handset in an upright position.
- Do not hold the handset where you would block the signal.
- Metal and reinforced concrete may affect cordless telephone performance.

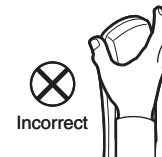
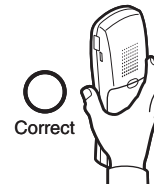

Wall Mounting the Base

This phone can be mounted on any standard wall plate.

- 1) Snap the wall mount adapter into the notches on the base top.
- 2) Plug the AC adapter into the DC IN 9V jack.
- 3) Wrap the AC adapter cord inside the molded wiring channel as shown.
- 4) Plug the AC adapter into a standard 240V AC wall outlet.
- 5) Plug the telephone cord into the TEL LINE jack.
- 6) Plug the telephone cord into the telephone outlet.
- 7) Align the mounting slots on the base with the mounting posts on the wall. Then push in and down until the phone is firmly seated.

Note: DO NOT use an AC outlet controlled by a wall switch.

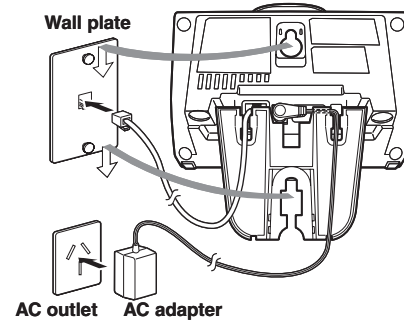
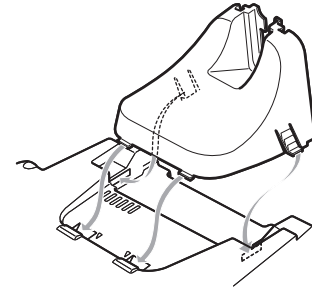

Direct Wall Mounting

If you don't have a standard wall plate, you can mount your phone directly to the wall. Before doing this, consider the following:

- Avoid electrical cables, pipes, or other items behind the mounting location that could cause a hazard when inserting screws into the wall.
- Try to mount your phone within 1.5m of a working phone jack to avoid excessive wire lengths.
- Make sure the wall material is capable of supporting the weight of the base and handset.
- Use #10 screws with a minimum length of 35mm, with anchoring devices suitable for the wall material where the base unit will be placed.

- 1) Insert two mounting screws into the wall, using the appropriate anchoring device, 100mm apart. Allow about 3mm between the wall and screw heads for mounting the phone.
- 2) Refer to the steps on page 13 to complete the mounting process.

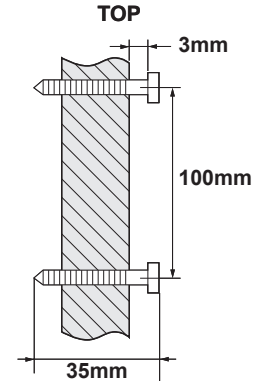

Installing the Battery

Use only the Uniden BT-909 rechargeable battery pack supplied with your cordless telephone.

Follow the steps below to install the handset battery.

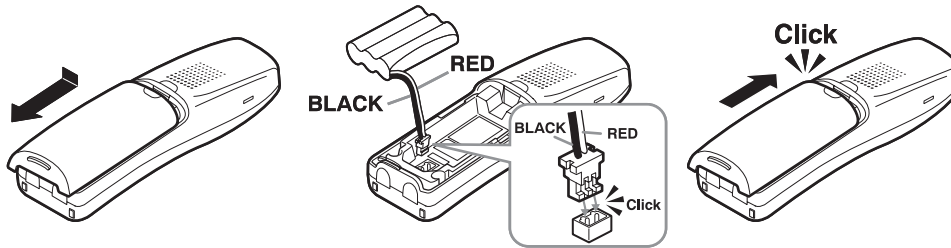

- 1) Press in on the handset battery case cover (use the finger indentation for a better grip) and slide the cover downward to remove.
- 2) Plug the battery cable into the battery jack. Be sure to match the red and black wires to the label near the jack. The cable should snap into place. Gently pull on the battery cable. If the battery connector comes loose, try connecting again until the battery snaps into place.
- 3) Place the battery case cover back on the handset and slide it upwards until it clicks into place.

Connecting the Base and Charging the Handset

- 1) Connect the AC adapter to the DC IN 9V jack.

CAUTION: To avoid risk of fire and shock, only use the Uniden AAD-041S AC adapter.

- 2) Connect the AC adapter to a standard 240V AC wall outlet.
DO NOT use an AC outlet controlled by a wall switch.
- 3) Place the handset in the base with the LCD screen facing forward.
- 4) Make sure that the charge LED illuminates. If the LED does not illuminate, check to see that the AC adapter is plugged in and the handset makes good contact with the charging contacts.
- 5) Charge your handset at least 15 to 20 hours before plugging into the phone line.

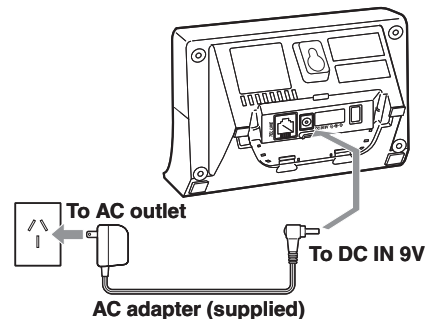

Installing the Belt Clip

Line up the holes on each side of the handset. To attach the belt clip, insert into the holes on each side of the handset. Press down until it clicks.

To remove the belt clip, pull either side of the belt clip to release the tabs from the holes.

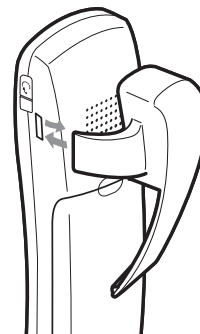

Connecting to the Phone Line

Once the battery pack is fully charged, connect the telephone cord to the TEL LINE jack and to a telephone jack.

High Speed Internet

If your phone line has High Speed Internet please ensure you are using an approved line filter before connecting the telephone cord.

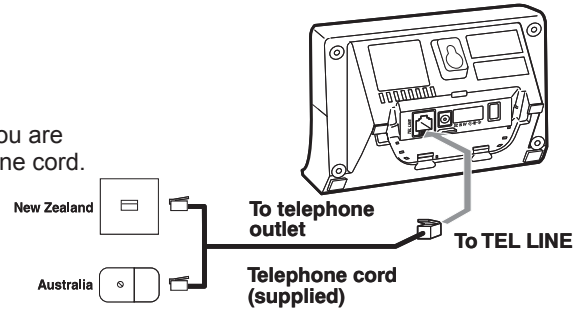

Testing the Connection

Try making a call. If your call does not connect or you cannot get a dial tone, try the following steps:

- 1) Make sure the AC adapter cord is securely connected to the DC IN 9V jack and a standard power outlet.
- 2) Check to make sure the battery is fully charged. (If you don't see the "battery full" icon, check to make sure the battery is properly connected).

Basic Setup

Activating Personal (Distinctive) Ring

You can assign special ringer tones to anyone in your phonebook. When your phone gets a call, it looks up the Caller ID information in your phonebook. If you've assigned a personal ringer to that number, the phone uses it so you know who is calling. To turn the personal ring on or off, follow these steps:

- 1) Press **[menu/clear]**. Select the HANDSET SETUP menu, and then the PERSONAL RING submenu.
- 2) Move the cursor to select ON or OFF.
- 3) Press **[select/✉]**. You will hear a confirmation tone.

```
Personal Ring
▶ On
Off
```

Activating the Key Touch Tone

Key Touch Tone is the tone your keypad makes when keys are pressed. You can turn this tone on or off.

- 1) Press **[menu/clear]**. Select the HANDSET SETUP menu, and then the KEY TOUCH TONE submenu.
- 2) Move the cursor to select ON or OFF.
- 3) Press **[select/✉]**. You will hear a confirmation tone.

```
Key Touch Tone
▶ On
Off
```

Name Tag

Name Tagging works with the caller display number from Caller ID. You will need to subscribe to the Caller ID feature with your phone company for Name Tagging to work.

When the phone rings, the received caller display number is compared to numbers stored in the phonebook. If there is a match then any name stored with the phonebook number will be displayed. To change the Name Tagging setting, follow the steps listed below.

- 1) Press **[menu/clear]**. Select the GLOBAL SETUP menu, and then the NAME TAG submenu.
- 2) Move the cursor to select ON or OFF.
- 3) Press **[select/✉]**. You will hear a confirmation tone.

Insert 0

This feature adds "0" or "00" at the beginning of the number received from Caller ID. The default setting for New Zealand is ON. The default setting for Australia is OFF. To change the Name Tagging setting, follow the steps listed below.

- 1) Press **[menu/clear]**. Select the GLOBAL SETUP menu, and then the INSERT 0 submenu.
- 2) Move the cursor to select ON or OFF.
- 3) Press **[select/✉]**. You will hear a confirmation tone.

Setting up Voice Mail

If you subscribe to a voice mail service, you can use your phone to access your voice mailbox. The new message LED flashes whenever you have messages waiting in your voice mailbox. If you have programmed your access number into your phone, you can simply press **[select/✉]** to access your voice mail. When you subscribe to the service, your voice mail provider provides you with the access number and the required voice mail signaling tone.

Programming One-Touch Voice Mail Access

You can program your voice mail access number to the Voice Mail key on each handset so you can get your messages at the touch of a button. Your voice mail service provider will supply you with the access number. This number may be simply a phone number.

To edit the voice mail number, follow the steps below:

- 1) Press **[menu/clear]**.
- 2) Move the cursor to HANDSET SETUP menu and press **[select/✉]**.
- 3) Move the cursor to EDIT VOICE MAIL and press **[select/✉]**.
- 4) Enter your personal access number (up to 20 digits).
- 5) If you need to have the phone wait before sending the next digits, press **[redial/pause]** to insert a two-second pause in the dialing sequence. For a longer pause, press **[redial/pause]** multiple times. A **F** appears in the display each time you press **[redial/pause]** and each pause counts as one digit.
- 6) Press **[select/✉]** when you are finished.



Edit V_mail No.

Resetting the Voice Message Waiting Indicator

When you receive a new voice mail message, the LED on the top of the handset flashes. In the event your message alert tone gets out of sync with your phone company's voice messaging system, you can reset back to its original "no messages waiting" state. To reset, press and hold **[find hs]** on the base for 5 seconds. A beep sounds and the message alert tone is reset.

Adding Accessory Handsets

Your phone supports up to eight (8) handsets, including any handsets supplied with your phone. Accessory handsets do not need to be connected to a phone jack. You can now place a fully-featured cordless handset anywhere AC power is available to connect the handset charger. All the handsets ring when a call is received.

Compatible Handsets

Your phone is compatible with the **WDSS 5305**. If you purchase an accessory handset, you must register the handset to the base before use. Accessory handsets will not operate until they are registered.

Charging Accessory Handsets

The handset is powered by a rechargeable battery pack. The battery recharges automatically when the handset is placed in the charger.

- 1) Connect the AC adapter to the DC IN 9V jack and to a 240V AC outlet that is not controlled by a wall switch.

Caution: Use only the Uniden AAD-600S adapter.

- 2) Set the charger on a desk or tabletop, and place the handset in the charger with the keypad facing forward.
- 3) Make sure that the charge LED illuminates. If the LED does not illuminate, check to see that the AC adapter is plugged in and the handset makes good contact with the base charging contacts.
- 4) Charge the handset battery pack for at least 15-20 hours before using your new cordless telephone for the first time.

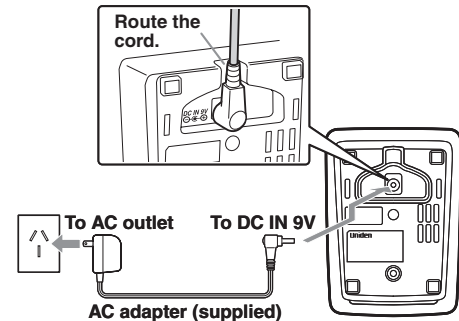

Registering WDSS 5305 Accessory Handsets

Your phone supports a total of eight (8) cordless handsets. Handset(s) supplied in the box with the phone base are pre-registered at the factory. If you purchase an accessory handset, you need to register the handset before use. Only one handset can be registered at a time. When charged, pre-registered handsets display a handset ID number. Handsets that have not been registered display.

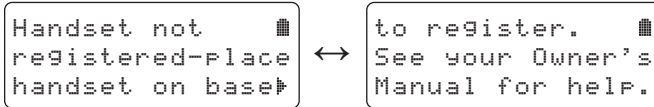

- 1) Before registering the **WDSS 5305** accessory handset, the battery pack **MUST** be charged for 15-20 hours.
- 2) To register the **WDSS 5305** handset:
Place the handset in the telephone base charging cradle to begin registration.
- 3) During the registration process, **HANDSET REGISTERING** will appear in the LCD. When **REGISTRATION COMPLETE** is displayed, the handset has been registered to the base. If **REGISTRATION FAILED** appears, please try these steps again. A handset ID will be automatically assigned when registration is complete.

Note: If an accessory handset has ever been registered to a base, you must reset the handset before you can register it to a new base. See **Resetting Handsets** on page 23.

Resetting Handsets

If you want to register the handset to a different base or replace a handset with another one, you must first clear the registration information from the base and the handset.

To clear the registration information, please follow these steps:

- 1) Press and hold **[*]** and **[#]** for at least 5 seconds, until the SYSTEM RESET menu appears.
- 2) Select the DEREGISTER HS submenu. WHICH HANDSET? appears in the display.
- 3) Use **[▲]** and **[▼]** to select the handset which you are operating, and then press **[select/✉]**. DEREGISTER HS appears.
- 4) When the phone asks you to confirm, move the cursor to select YES, and then press **[select/✉]**. You will hear a confirmation tone.

| | |
|----------------|----|
| Which Handset? | |
| ▶ Handset | #1 |
| Handset | #2 |

Note: The handset first clears its registration information from the base and then deletes the link to the base from its own memory. The handset will now display HANDSET NOT REGISTERED-PLACE HANDSET ON BASE TO REGISTER. SEE YOUR OWNER'S MANUAL FOR HELP. If the handset cannot contact the base, it will display UNAVAILABLE. If this happens, see Resetting the Handset Without the Base on page 45. For instructions on registering the handset, see page 22.

Setting Up the Phonebook

Your handset can store up to 70 names and numbers in your phonebook. When all the phonebook entries are full, you will hear a beep and MEMORY FULL appears. You cannot store any additional names and numbers unless you delete some of the existing ones.

You can also use the phonebook entries to store a group of numbers (up to 20 digits) that you may need to enter once your call connects. This is referred to as chain dialing. See Chain Dialing from the Phonebook on page 31.

Creating Phonebook Entries

To store names and numbers in your phonebook, please follow these steps:

- 1) When the phone is in standby mode, press [].
- 2) To create a new phonebook entry, move the cursor to select CREATE NEW, and press [select/✉]. EDIT NAME appears.

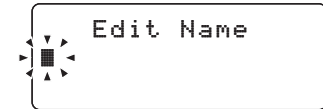

- 3) **Enter the name for this entry (EDIT NAME).**

Use the keypad to enter a name for this entry; the name can contain up to 16 characters. (See Entering Text from Your Handset on page 11 for instructions on entering text.) If you do not want to enter a name for this entry, your phone will store this entry as <NO NAME>. Press [select/✉] when you are finished.

- 4) **Enter the number for this entry (EDIT NUMBER).**

Once you have stored a name, EDIT NUMBER appears next. Use the number keypad to enter the phone number; the phone number can contain up to 20 digits. If you need the phone to pause between digits when it's dialing (for example, to enter an extension or an access code), press [redial/pause] to insert a two-second pause. You will see a  in the display. You can also use more than one pause together if two seconds is not long enough. Each pause counts as one digit.

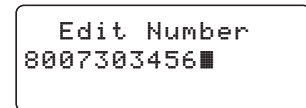

5) Assign a personal ring tone for this entry (PERSONAL RING).

You can attach a special ring tone to each phonebook entry; the phone will use this ring tone when this person calls. Use [▲] and [▼] to select one of the 7 different ring tone options (see Selecting a Ring Tone on page 28 for a complete list of ring tones). As you scroll through the tones, you will hear a sample of each tone. When you hear the ring tone you want to use, press [select/✉]. If you do not want to use a personal ring tone for this phonebook entry, choose NO SELECTION; the phone will use your standard ring tone setting.

```
Personal Ring
▶No Selection
Flicker
```

Finding a Phonebook Entry

Press [Ⓜ] to open the phonebook, and then select DIAL/EDIT or press [Ⓜ] again. Phonebook entries are stored in alphabetical order. To scroll through the phonebook from A to Z, press [▼]. To scroll through the phonebook from Z to A press [▲].

You can also use the letters on the number keys to jump to a name that starts with that letter. Press a number key ([2] through [0]) once for the first letter, twice for the second letter, and so on. The phonebook jumps to the first entry that begins with the letter you entered; you can then use [▲] and [▼] to scroll to other entries. For example, to search for an entry beginning with the letter M, press 6 once.

To close the phonebook, press [Ⓜ]. During a call, press [Ⓜ] again instead of [Ⓜ] to close the phonebook.

Editing an Existing Phonebook Entry

- 1) With the phone in standby, press [Ⓜ] to open the phonebook.
- 2) Select DIAL/EDIT or press [Ⓜ] again.
- 3) Find the entry you want to edit and press [select/✉].
- 4) Follow the steps for Creating Phonebook Entries on page 24. If you do not wish to change the information at any step, simply press [select/✉] to go to the next step.

Storing Caller ID or Redial Numbers in the Phonebook

You can store Caller ID records or redial numbers in the phonebook so you can use them later. Go to the Caller ID or redial list and select the number you want to store. (If the Caller ID information did not include the number, then you will not be able to store it.)

- 1) When the phone is in standby, press **[*#]** to open the Caller ID list or **[redial/pause]** to open the redial list.
- 2) Use **[▲]** and **[▼]** to scroll through the Caller ID records or redial numbers. When you come to the information you want to store, press **[select/✉]**. EDIT NAME appears.
- 3) If the phone number is already stored in memory, you will hear a beep, and THIS DATA IS ALREADY SAVED! appears in the display. The number will not be stored.

Continue by following the steps for Creating Phonebook Entries on page 24.

Deleting Phonebook Entries

You can delete individual phonebook entries or delete all the phonebook entries at once.

- 1) When the phone is in standby, press **[✘]**.
- 2) To delete a single phonebook entry, move the cursor to select DIAL/EDIT, and then press **[select/✉]** or press **[✘]** again.
- 3) Find the phonebook entry you want to delete and press **[menu/clear]**.
- 4) DELETE ENTRY? appears in the display. Select YES, and then press **[select/✉]**.
- 5) You will hear a confirmation tone, and DELETED! appears in the display.

Deleting all the phonebook entries at once

- 1) When the phone is in standby, press **[✘]**.
- 2) Move the cursor to select DELETE ALL, and press **[select/✉]**.
- 3) DELETE ALL? appears in the display. Select YES and then press **[select/✉]**.
You will hear a confirmation tone, and DELETED! appears in the display.

```
Phonebook : 50  
Copy  
▶Delete All
```

Copying Phonebook Entries to Another Handset

If you have more than one handset, you can transfer phonebook entries from one handset to another without having to re-enter names and numbers. You can transfer one phonebook entry at a time or all phonebook entries at once.

- 1) When the phone is in standby, press [].
- 2) Move the cursor to select COPY, and then press [select/✉].
- 3) Move the cursor to select the handset which you want to transfer the entries to and then press [select/✉].
- 4) Move the cursor to select ONE MEMORY or ALL MEMORY, and then press [select/✉].
- 5) If you select ALL MEMORY, ARE YOU SURE? appears on the display screen. Move the cursor to select YES, and then press [select/✉].
- 6) If you select ONE MEMORY, find the phonebook entry you want to transfer and then press [select/✉].
- 7) The phonebook entries will be transferred to the designated handset. During the copy process, the receiving handset shows RECEIVING and the Handset ID of the sending handset.
- 8) When the transfer is completed, DONE! appears on the handset.



```
Copy Phonebook
▶ One Memory
  All Memory: 50
```

Note: If your phonebook contains 70 entries, you cannot store any new phonebook entries. You will hear a beep, and MEMORY FULL appears on the display. If the selected handset is out of range or data transfer is cancelled, UNAVAILABLE appears in the display. Phonebook listings will not be transferred.

Customizing Your Phone

Selecting a Ring Tone (Handset only)

You may choose from 4 melodies or 3 tones for your phone's primary ring tone. Each handset can use a different ringer tone or melody. The available ring tones are listed below:

Melodies

Fur Elise (ELISE)

We Wish You A Merry Christmas (MERRY-XMAS)

Aura Lee (AURA LEE)

Waltzing Matilda (W Matilda)

Tones

Flicker

Clatter

Wake Up

- 1) Press **[menu/clear]**. Select the HANDSET SETUP menu, and then the RINGER TONES submenu.
- 2) Move the cursor to select a ring tone. As each ring tone is selected, you will hear a sample of the ring tone.
- 3) When you hear the tone you want to use, press **[select/ⓧ]**. You will hear a confirmation tone.

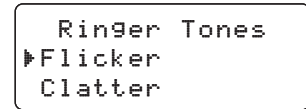

Activating AutoTalk (Handset only)

AutoTalk allows you to answer the phone simply by removing the handset from the cradle. You do not have to press a button to answer the call.

- 1) Press **[menu/clear]**.
- 2) Select the HANDSET SETUP menu, and then the AUTOTALK submenu.
- 3) Select ON or OFF, and press **[select/✉]**. You will hear a confirmation tone.

```
AutoTalk
On
▶Off
```

Activating Any Key Answer (Handset only)

Any Key Answer allows you to answer the phone by pressing any key on the dial pad.

- 1) Press **[menu/clear]**.
- 2) Select the HANDSET SETUP menu, and then the ANY KEY ANSWER submenu.
- 3) Select ON or OFF, and then press **[select/✉]**. You will hear a confirmation tone.

```
Any Key Answer
On
▶Off
```

Activating Clarity Boost for All Calls (Handset only)

Allows clarity boost feature to be turned on for all calls. See Using the Clarity Boost Feature on page 36.

- 1) Press **[menu/clear]**.
- 2) Select the HANDSET SETUP menu, and then the CLARITY BOOST submenu.
- 3) Select ON or OFF, and then press **[select/✉]**. You will hear a confirmation tone.



The clarity boost feature uses additional battery power therefore talk time will be reduced. Return handset to charger when not in use to keep battery fully charged.

```
Clarity Boost
On
▶Off
```

Using Your Phone

| | From a cordless handset | From a handset speaker phone |
|-------------------------|--|--|
| Making a call | 1) Remove the handset from the charging cradle. 2) Press [*/flash] . 3) Listen for the dial tone. 4) Dial the number. OR 1) Remove the handset from the charging cradle. 2) Dial the number. 3) Press [*/flash] . | 1) Remove the handset from the charging cradle. 2) Press [*☎] . 3) Listen for the dial tone. 4) Dial the number. OR 1) Remove the handset from the charging cradle. 2) Dial the number. 3) Press [*☎] . |
| Answering a call | 1) Pick up the handset. (If AutoTalk is on, the phone will answer when you remove the handset from the charging cradle.) 2) Press [*/flash] . (If Any Key Answer is on, you can also press any key on the twelve-number keypad.) | 1) Pick up the handset. (If AutoTalk is on, the phone will answer when you remove the handset from the charging cradle.) 2) Press [*☎] . |
| Hanging up | Press [*] or return the handset to the cradle. | Press [*] or return the handset to the cradle. |



Making a Call from the Phonebook

- 1) When the phone is in standby, press [] to open the phonebook.
- 2) Move the cursor to select DIAL/EDIT, and then press [select/✉].
- 3) Find the phonebook entry you want to call (see Finding a Phonebook Entry on page 25).
- 4) Press [flash] or [] to dial the number.



Note: You can also press [flash] or [] before you open the phonebook. When you come to the phone number you want to dial, press [select/✉].

Chain Dialing from the Phonebook

You can use the phonebook entries to store a group of numbers (up to 20 digits) that you may need to enter once your call connects. Once the call has connected you will then do the following:

- 1) Press [].
- 2) Use [] or [] to select the phonebook entry you want to call.
- 3) Press [select/✉]

Switching to the Handset Speakerphone During a Call

To switch a normal call to the speakerphone, press [] on the handset. To switch from a speakerphone call to a normal call, press [].

Using Caller ID, Call Waiting, and Redial Lists

If you subscribe to Caller ID from your phone company, your phone will show you the caller's phone number and name (if available) whenever a call comes in. If you subscribe to both Call Waiting and Caller ID, the phone also shows you the name and the number of any call that comes in while you're on the line.

Using the Caller ID List

You can store up to 30 Caller ID numbers in each handset. Caller ID records are stored from newest to oldest. Once your Caller ID list is full and you receive an incoming call, the oldest record will be automatically deleted to make room for the new record.

To open the Caller ID list, press **[*#]** (on the right side of the four-way key). The phone will show the number of new Caller ID records and the total number of stored records. Use **[▲]** and **[▼]** to scroll through the list, or enter a letter on the keypad to jump to the first Caller ID name that starts with that letter.

Making a Call from a Caller ID Record

- 1) When the phone is in standby, press **[*#]** to open the Caller ID list.
- 2) Use **[▲]** and **[▼]** to find the Caller ID record you want to dial.
- 3) Press **[*/flash]** or **[*☎]** to dial the number.

Note: You can also press **[*/flash]** or **[*☎]** before you open the caller ID list. When you come to the phone number you want to dial, press **[select/✉]**.

Deleting Caller ID Numbers

To delete only one Caller ID number, go to the Caller ID list and select the number you want to delete. Press **[menu/clear]**. When the phone asks you to confirm, select YES.

To delete all the Caller ID numbers, go to the Caller ID list and press **[menu/clear]**. Select YES when asked if you want to DELETE ALL.

Note: When you delete a Caller ID number, you delete it permanently.

Using Call Waiting

If you have Call Waiting service and a second call comes in when you are on the phone, a call waiting tone will sound. (If you subscribe to Caller ID on Call Waiting, the handset displays the name and phone number of the waiting call.)

For Australian Model:

Press **[*/flash]** and then **[2]** on the handset to accept the waiting call. The first caller is put on hold, and you will hear the new caller after a short pause. To return to the original caller, press **[*/flash]** and then **[2]** again.

For New Zealand Model:

Press **[*/flash]** on the handset to accept the waiting call. The first caller is put on hold, and you will hear the new caller after a short pause. To return to the original caller, press **[*/flash]** again.

Note: You must subscribe through your telephone provider to receive Call Waiting services.

Redialing a Number

You can quickly redial the last 5 numbers dialed on each handset.

- 1) With the phone in standby, press the **[redial/pause]** to open the redial list.
- 2) Use **[▲]** and **[▼]** or **[redial/pause]** to scroll through the redial list.
- 3) When you find the number you want to dial, press **[/flash]** or **[▶▶]** on the handset to dial the number.

Note:

- If the number exceeds 32 digits, only the first 32 digits are retained in redial memory.
- If the redial memory is empty, EMPTY appears in the display and you will hear a beep.

Deleting a Redial Record

If you want to delete a phone number from the handset's redial list, follow the steps below:

- 1) With the phone in standby, press **[redial/pause]**.
- 2) Use **[▲]** and **[▼]** to scroll through the redial list.
- 3) When you find the redial number you want to delete, press **[menu/clear]**.
- 4) Select YES, and press **[select/✉]**. The redial number is deleted.

Adjusting the Ringer, Earpiece and Speaker Volume

Adjusting the Ringer Volume

You can choose from four ringer volume settings on the handset (off, low, medium, and high). With the phone in standby, use [▲] or [▼] on the handset to adjust the ringer volume.

Adjusting the Earpiece Volume

You can choose from six volume levels for the earpiece. To adjust the earpiece volume while on a call, press [▲] (to make it louder) or [▼] (to make it softer).

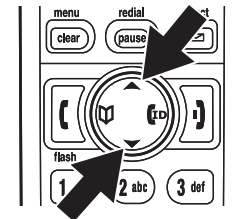

Adjusting the Speaker Volume

You can choose from six volume levels for the handset speakerphone. To adjust the speaker volume while on a call, press [▲] (to make it louder) or [▼] (to make it softer).

Adjusting the Audio Tone

If you aren't satisfied with the audio quality of your phone, you can adjust the Audio Tone of the earpiece while on a call. Your phone gives you three audio tone options: low, natural and high; the default setting, Natural Tone, is recommended for hearing aid users. Audio tone adjustments only apply to the earpiece, not the speakerphone.

To adjust the audio tone:

- 1) With the phone in talk mode, press **[select/✉]** to cycle through the three audio tone options.
- 2) When the desired option appears on the display, stop.
- 3) After two seconds, the displayed audio tone is set, and the display returns to normal.

Using the Clarity Boost Feature

If you encounter interference while using your phone, you can manually improve the sound by setting the clarity booster to on. To turn it on for the current call only, while you are on a call:

- 1) Press **[menu/clear]**.
- 2) Move the cursor to CLARITY BOOST, and then press **[select/✉]**. BOOST ON and  appear in the display.

Use the same procedure to turn off clarity booster. BOOST OFF appears.

The clarity boost feature can also be turned on for all calls. See Activating Clarity Boost for All Calls on page 29.

The clarity boost feature uses additional battery power therefore talk time will be reduced. Return handset to charger when not in use to keep battery fully charged.

Finding a Lost Handset

To locate a misplaced handset, press **[find hs]** on the base when the phone is in standby. All registered handsets will beep for one minute, and PAGING appears on the handset display. To cancel paging, press **[find hs]** again or any key on the found handset.

Using Conference and Transfer

Conferencing

If you have more than one handset, up to three people can participate in a conference call. A three-way conference call consists of an outside line and two handsets. You can easily join a call already in progress.

- 1) Press **[*/flash]** or **[*]]]** to join the call.
- 2) To hang up, return the handset to the cradle or press **[*]**. The other party will still be connected to the call.

Transferring a Call

You can transfer a call from one handset to another.

From the handset:

- 1) During a call, press **[hold/int'com/xfer]**.
- 2) Use **[▲]** or **[▼]** to select the handset you want to transfer the call to, then press **[select/☑]**. The call will automatically be placed on hold, and a paging tone sounds. To cancel the transfer, press **[*/flash]** or **[*]]]**.
- 3) When another handset accepts the transferred call, you will be disconnected. If you want to rejoin the call, press **[*/flash]** again or **[*]]]**.

Answering a Transferred Call

When a handset receives a call transfer, it sounds a paging tone; handsets also show the ID of the handset that is paging. To accept the call transfer:

- 1) To answer the page and speak to the transferring handset, press **[*/flash]** or **[hold/int'com/xfer]** on the handset.
- 2) To accept the call and speak to the caller, press **[*/flash]**.
- 3) When you accept the transferred call, the transferring handset will be disconnected.

Only the first handset to answer the transfer page will be connected to the call. If the transfer page is not picked up within one minute, the operation will be canceled.

Using Special Features



Muting the Ringer (One call only)

While the phone is ringing, press **[j]** to mute the ringer for this call. The phone will ring again on the next call.

Muting the Microphone

Mute turns off the microphone so the caller can't hear you. This only works while you are on a call.

From the handset:

- 1) Press **[menu/clear]**.
- 2) Move the cursor to select MUTE and then press **[select/ⓧ]**. MUTE ON and  appear in the display;  remains while muting is on.
- 3) To cancel muting, repeat the procedure, MUTE OFF appears.

Privacy Mode

If you don't want other handsets to interrupt you while on a call, turn on privacy mode. As long as your handset is in privacy mode, other handsets can't join your call or make any calls of their own: their displays will show UNAVAILABLE.

- 1) While on a call, press **[menu/clear]**.

- 
- 2) Move the cursor to CALL PRIVACY, and then press **[select/✉]**. PRIVACY MODE ON appears in the display for 2 seconds; **P** appears and remains in the display until the feature is turned off.

To turn privacy mode off, repeat the procedure listed above.

Using the Intercom

You can use the intercom to talk to another handset without using the phone line.

Making an Intercom Page

From the handset:

- 1) With the phone in standby, press **[hold/int'com/xfer]**.
- 2) Use **[▲]** or **[▼]** to select the handset you want to talk with, then press **[select/✉]**. Select ALL to page all other handsets.
- 3) To cancel the intercom page, press **[*]**.

Note: Intercom paging will be canceled if any of the following things occur:

- You receive an outside call or an intercom page while selecting the other handset.
- You do not select a handset within 30 seconds.
- The party does not answer the page within one minute.
- The party is busy.
- The party is out of range (UNAVAILABLE appears in the display).

Answering an Intercom Page

When the intercom page tone sounds, the display will show the ID of the handset that is paging.

- 1) Press **[flash]** or **[hold/int'com/xfer]**. If AutoTalk is on, the handset will automatically answer the page when you remove the handset from the cradle.
- 2) To hang up an intercom page from the handset, press **[*]**.

Installing the Optional Headset

Your phone may be used with an optional headset. To use this feature, insert the headset plug into the headset jack. Your phone is ready for hands-free conversations. (Headsets may be purchased by calling the Uniden Parts Department. See back cover page for contact information.)

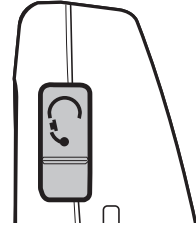

Maintenance

Specifications

| | |
|------------------------|---|
| Operating Temperature | 32° F to 122° F (0° C to 50° C) |
| AC Adapter Part Number | Base: AAD-041S Charging Cradle: AAD-600S |
| Input Voltage | Base: 240V AC, 50 Hz Charging Cradle: 240V AC, 50 Hz |
| Output Voltage | Base: 9V DC @ 350mA Charging Cradle: 9V DC @ 210mA |
| Battery Part Number | BT-909 |
| Capacity | 3.6V DC @ 600mAh |

Notes:

- Use only the supplied AAD-041S and AAD-600S AC adapters.
- Do not use any other AC adapter.
- Do not place the power cord where it creates a trip hazard or where it could become chafed and create a fire or electrical hazard.
- Do not place the base in direct sunlight or subject it to high temperatures.

Battery Replacement and Handling

With average use, your phone's battery should last approximately one year. A replacement Uniden battery may be purchased by visiting our website at www.uniden.com.au for Australian model, www.uniden.co.nz for New Zealand model.

Cleaning the Battery Contacts

To maintain a good charge, clean the charging contacts on the handset once a month. Dampen a cloth with plain water. Gently rub the damp cloth over the charging contacts until all visible dirt is removed. Dry the contacts thoroughly before returning the handset to the charging cradle.

Caution: Do not use paint thinner, alcohol, or other chemical products. Doing so may discolor the surface of the telephone and damage the finish.

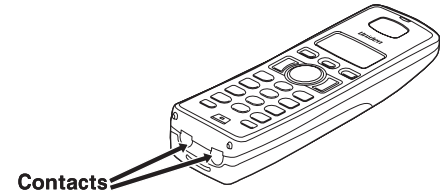

Warning

To avoid the risk of personal injury or property damage from fire or electrical shock, use only Uniden AAD-041S (9V 350mA) and AAD-600S AC adapters and Uniden BT-909 battery pack with your phone.

Caution:

- Use only the specified Uniden battery pack BT-909.
- Do not remove the batteries from the handset to charge them.
- Never throw the battery into a fire, disassemble, or heat them.
- Do not remove or damage the battery casing.
- A replacement Uniden adapter or battery may be purchased by calling Uniden's Parts department. See back cover page for contact information.

Low Battery Alert

When the battery pack is very low, the phone is programmed to eliminate functions in order to save power. When LOW BATTERY appears in the display and the phone is in standby, none of the keys will operate. If you are on a call, complete your conversation as quickly as possible, and return the handset to the charging cradle.

The battery pack needs to be charged when the empty battery icon appears.



Talk and Standby Times

With average use, your handset battery provides approximately 5 hours of talk time and approximately 7 days of standby time. When your handsets are not being used and are left off of their charging cradles, the battery will gradually discharge. You can achieve optimum battery life and performance by returning the handset to the charging cradle after each use. If the handset is left off of the charging cradle, the actual talk time duration will be reduced respective to the amount of time the handset is off of the charging cradle.

Troubleshooting

Resetting the Handset

You may need to reset your handset in the following instances:

- When you want to change the digital security code.
- You lose a handset and purchase a new one.
- You get the message Registration Failed when you try to register the handset.
- You are unable to register any handsets to the base.
- When you register new handsets to the base, the handset IDs do not match. (For example, the handset registers as "Handset #4" but you only have two handsets.)
- When you are instructed to by one of Uniden's call center representatives.

- 1) Press and hold **[*]** and **[#]** for more than 5 seconds. Select DEREGISTER HS.
- 2) Select the handset which you are operating, then press **[select/✉]**.
- 3) The phone will ask you to confirm the deregistration. Select YES. The selected handset will clear its registration information from the base, and then delete the link to the base from its own memory.
- 4) When the base information is deleted, the handset displays HANDSET NOT REGISTERED-PLACE HANDSET ON BASE TO REGISTER. SEE YOUR OWNER'S MANUAL FOR HELP.
- 5) Re-register the handset to the base (see Registering Accessory Handsets on page 22).

If the handset cannot contact the base, it will display OUT OF RANGE. Make sure the handset is in range of the base and the base is connected to power.

Resetting the Handset Without the Base

If your original base is not available for some reason (for example, it is lost or somehow incapacitated), you can still reset the handset and use it with another base.

- 1) Press and hold **[*]** and **[#]** for at least 5 seconds.
- 2) Move the cursor to select BASEUNAVAILABLE and then press **[select/✉]**. BASE UNAVAILABLE appears.
- 3) Move the cursor to select YES, and then press **[select/✉]**. You hear a confirmation tone, and the handset deletes its own base information without contacting the base. The handset displays HANDSET NOT REGISTERED-PLACE HANDSET ON BASE TO REGISTER. SEE YOUR OWNER'S MANUAL FOR HELP.
- 4) Register the handset to the new base (see Registering Accessory Handsets on page 22).

Changing the Digital Security Code

The digital security code is an identification code used to connect the handset and the base. Your unit ships from the manufacturer with a preset security code. Resetting this code is not normally necessary. In the rare situation that you suspect another cordless telephone is using the same security code or if you are instructed to change this code by a manufacturer's Call Center Representative, you can change the code. To change the digital security code:

- 1) Reset all of your handsets (see Resetting the Handset on page 44).
- 2) Re-register each handset (see Registering Accessory Handsets on page 22).

Traveling Out of Range

During a call, if you move your handset too far from your base, noise may increase. If you pass the range limit of the base, the handset will beep, display OUT OF RANGE, and then go to standby. The base will maintain the connection for 30 seconds after the handset goes out of range. If you move the handset back within range of the base within 30 seconds, press **[*/flash]** or **[*]]]** to pick up the call again.

Common Issues

If your phone is not performing to your expectations, please try these simple steps first. If these steps do not solve your problem, please visit our website customer support page at www.uniden.com.au for Australia, www.uniden.co.nz for New Zealand.

| Symptom | Suggestion |
|---|---|
| The charge LED won't illuminate when the handset is placed in the cradle. | <ul style="list-style-type: none">• Make sure the AC adapter is plugged into the base or the charger (if you have more than one handset) and wall outlet.• Make sure the handset is properly seated in the cradle.• Make sure the charging contacts on the handset are clean. |
| The audio sounds weak. | <ul style="list-style-type: none">• Move the handset and/or base away from metal objects or appliances and try again.• Make sure that you are not too far from the base. |
| Can't make or receive calls. | <ul style="list-style-type: none">• Make sure that you are not too far from the base.• Make sure the line is not in use. If an outside call is already using a line, you cannot use that line to make another outside call.• Make sure your handset is registered to the main base unit.• Check both ends of the base telephone line cord.• Make sure the AC adapter is plugged into the base and wall outlet.• Disconnect the AC adapter and reconnect.• Change the Digital Security Code (see Changing the Digital Security Code on page 45). |
| Severe noise interference. | <ul style="list-style-type: none">• Keep the handset away from microwave ovens, computers, remote control toys, wireless microphones, alarm systems, intercoms, room monitors, fluorescent lights, and electrical appliances.• Move to another location or turn off the source of interference. |
| The Caller ID does not display. | <ul style="list-style-type: none">• The call was placed through a switchboard.• Call your telephone provider to verify your Caller ID service is current. There may be a problem with your Caller ID service. |

| Symptom | Suggestion |
|--|---|
| The handset doesn't ring or receive a page. | <ul style="list-style-type: none"> • Make sure that you are not too far from the base. • Make sure that your handset is registered to the main base unit. • Charge the battery in the handset for 15 to 20 hours by placing the handset on the base or charging cradle. • Change the Digital Security Code (see Changing the Digital Security Code on page 45). |
| You cannot register the handset at the base. | <ul style="list-style-type: none"> • Charge the battery pack in the handset for 15 to 20 hours. • Change the Digital Security Code (see Changing the Digital Security Code on page 45). • Try resetting the handset (see Resetting the Handset on page 44). |
| The handset doesn't communicate with other handsets. | <ul style="list-style-type: none"> • Change the Digital Security Code (see Changing the Digital Security Code on page 45). • Make sure that you have registered all handsets (see Registering Accessory Handsets on page 22). |
| An extra handset can't join the conversation. | <ul style="list-style-type: none"> • Make sure there are not two handsets already using the conference feature. • Make sure that another handset is not in privacy mode. |

Liquid Damage

Moisture and liquid can damage your cordless phone.

- If the handset or base is exposed to moisture or liquid, but only the exterior plastic housing is affected, wipe off the liquid, and use as normal.
- If moisture or liquid has entered the plastic housing (i.e. liquid can be heard in the phone or liquid has entered the handset battery compartment or vent openings on the base), follow the steps below:

| Handset | Base |
|---|---|
| <ol style="list-style-type: none">1) Remove the battery cover and leave it off for ventilation.2) Disconnect the battery pack. Leave the battery cover off and the battery pack disconnected for at least 3 days.3) Once the handset is completely dry, reconnect the battery pack and the battery cover.4) Recharge the handset's battery pack for 15 to 20 hours before using. | <ol style="list-style-type: none">1) Disconnect the AC adapter from the base, cutting off electrical power.2) Disconnect the telephone cord from the base.3) Let dry for at least 3 days. |

IMPORTANT: You must unplug the telephone line while recharging the battery packs to avoid charge interruption.

CAUTION: **DO NOT** use a microwave oven to speed up the drying process. This will cause permanent damage to the handset, base and the microwave oven. After following these steps, if your cordless telephone does not work, please call our Customer Service Hotline (see back cover page).

Precautions!

Before you read anything else, please observe the following:

Warning!

Uniden Australia and Uniden New Zealand DOES NOT represent this unit to be waterproof. To reduce the risk of fire, electrical shock, or damage to the unit, DO NOT expose this unit to rain or moisture.

Rechargeable Nickel-Metal-Hydride Battery Warning

- This equipment contains a rechargeable Nickel-Metal-Hydride battery.
- The rechargeable batteries contained in this equipment may explode if disposed of in a fire.
- Do not short-circuit the battery.
- Do not charge the rechargeable battery used in this equipment in any charger other than the one designed to charge this battery as specified in the owner's manual. Using another charger may damage the battery or cause the battery to explode.

Rechargeable Batteries Must Be Recycled or Disposed of Properly.

Index

A

| | |
|----------------------|----|
| Answering calls..... | 30 |
| Any key answer | 29 |
| AutoTalk..... | 29 |

B

| | |
|-------------------------------|----|
| Base | |
| Installing | 16 |
| Parts of the base | 8 |
| Wall mounting..... | 13 |
| Battery | |
| Installing | 15 |
| Low battery alert | 43 |
| Replacement and handling..... | 42 |
| Talk and standby time..... | 43 |
| Belt clip..... | 16 |

C

| | |
|----------------------------------|--------|
| Call waiting | 33 |
| Caller ID..... | 32 |
| Deleting Caller ID records | 33 |
| Making calls from..... | 32 |
| Chain dialing..... | 31 |
| Clarity boost..... | 29, 36 |
| Conferencing | 37 |

D

| | |
|-----------------------------|----|
| Digital security code | 45 |
|-----------------------------|----|

F

| | |
|------------------------|----|
| Finding a handset..... | 36 |
|------------------------|----|

H

| | |
|--------------------------------|--------|
| Handset | |
| Accessory handsets..... | 21 |
| Choosing a ringer | 28 |
| Copying phonebook entries..... | 27 |
| Displays and icons..... | 9, 10 |
| Entering text | 11 |
| Finding..... | 36 |
| Parts of the handset | 7 |
| Registering | 22 |
| Resetting | 23, 44 |
| Standby screen..... | 10 |
| Hanging up | 30 |
| Headset | 40 |

I

| | |
|--------------------|----|
| Installation | 12 |
| Intercom..... | 39 |

K

| | |
|---------------------|----|
| Key touch tone..... | 18 |
|---------------------|----|

M

| | |
|--------------------------|----|
| Maintenance..... | 41 |
| Making calls..... | 30 |
| Using Caller ID | 32 |
| Using redial..... | 34 |
| Using the phonebook..... | 31 |
| Mute | |
| Microphone..... | 38 |
| Ringer..... | 38 |

O

| | |
|-------------------|----|
| Out of range..... | 45 |
|-------------------|----|

P

| | |
|---------------------------|----|
| Personal ring | 18 |
| Phonebook | 24 |
| Copying entries..... | 27 |
| Creating new entries..... | 24 |
| Deleting entries..... | 26 |

P

| | |
|---|----|
| Editing entries..... | 25 |
| Finding entries..... | 25 |
| Making calls from..... | 31 |
| Storing Caller ID or redial numbers..... | 26 |
| Privacy mode..... | 38 |

R

Redial

- Deleting a record 34
- Making calls with 34

Ringer

- Choosing a handset ringer 28
- Muting..... 38
- Personal ring 18

T

- Text, entering 11
- Transferring a call..... 37

V

- Voice Mail 20
- Voice Mail Programming..... 20
- Voice Message Waiting Indicator
 - Reset 20
- Volume, adjusting 35

W

- Wall mounting the base 13
- Warranty 54

Memo

Memo

One Year Limited Warranty

WDSS 5315, WDSS 5315+1 Corded Phone

Important: Evidence of original purchase is required for warranty service.

Warrantor: Uniden Australia Pty Limited A.B.N. 58 001 865 498
Uniden New Zealand Limited **Warranty is only valid in the original country of purchase.**

ELEMENT OF WARRANTY: Uniden warrants to the original retail owner for the duration of this warranty, its WDSS 5315 WDSS 5315+1 cordless phone (herein after referred to as the Product), to be free from defects in materials and craftsmanship with only the limitations or exclusions set out below.

WARRANTY DURATION: This warranty to the original retail owner only, shall terminate and be of no further effect ONE (1) year after the date of original retail sale. This warranty will be deemed invalid if the Product is;

- (A) Damaged or not maintained as reasonable and necessary,
- (B) Modified, altered or used as part of any conversion kits, subassemblies, or any configurations not sold by Uniden,
- (C) Improperly installed,
- (D) Repaired by someone other than an authorized Uniden Repair Agent for a defect or malfunction covered by this warranty,
- (E) Used in conjunction with any equipment or parts or as part of a system not manufactured by Uniden, or
- (F) Where the Serial Number label of the product has been removed or damaged beyond recognition.

Warranty only valid in the country of original retail/sale.

PARTS COVERED: This warranty covers for one (1) year, the Product and included accessories.

STATEMENT OF REMEDY: In the event that the Product does not conform to this warranty at any time while this warranty is in effect, the warrantor at its discretion, will repair the defect or replace the Product and return it to you without charge for parts or service. This warranty does not provide for reimbursement or payment of incidental or consequential damages.

This EXPRESS WARRANTY is in addition to and does not in any way affect your rights under the TRADE PRACTICES ACT 1974 (Cth) (Australia) or the CONSUMER GUARANTEES ACT (New Zealand).

PROCEDURE FOR OBTAINING PERFORMANCE OR WARRANTY: In the event that the product does not conform to this warranty, the Product should be shipped or delivered, freight pre-paid, with evidence of original purchase (eg. a copy of the sales docket), to the warrantor at:

UNIDEN AUSTRALIA PTY LIMITED

SERVICE DIVISION
345 Princes Highway,
Rockdale,
NSW 2216,
AUSTRALIA
Fax: (02) 9599 3278
www.uniden.com.au

UNIDEN NEW ZEALAND LIMITED

SERVICE DIVISION
150 Harris Road,
East Tamaki,
Auckland,
NEW ZEALAND
Fax: (09) 274 4253
www.uniden.co.nz



Uniden®

©2007 Uniden Australia Pty Limited/Uniden New Zealand Limited
Part Code UPZZ01880BZ(0) Printed in China

Free Manuals Download Website

<http://myh66.com>

<http://usermanuals.us>

<http://www.somanuals.com>

<http://www.4manuals.cc>

<http://www.manual-lib.com>

<http://www.404manual.com>

<http://www.luxmanual.com>

<http://aubethermostatmanual.com>

Golf course search by state

<http://golfingnear.com>

Email search by domain

<http://emailbydomain.com>

Auto manuals search

<http://auto.somanuals.com>

TV manuals search

<http://tv.somanuals.com>