

Uniden

POLARIS

VHF MARINE RADIO WITH
DIGITAL SELECTIVE CALLING (DSC)

A circular inset image showing a white Uniden wireless microphone with a small LCD screen displaying the number '16'.

**WIRELESS
MICROPHONE
CAPABILITY!**

Works with up to two wireless mic accessories (optional WHAM and WHAM2, not included).

owner's manual

Maritime Radio Services Operation

Warning!

This transmitter will operate on channels/frequencies that have restricted use in the United States. The channel assignments include frequencies assigned for exclusive use of the U.S. Coast Guard, use in Canada, and use in international waters. Operation in these frequencies without proper authorization is strictly forbidden. For frequencies/channels that are currently for use in the U.S. without an individual license, please contact the FCC Call Center at 1-888-CALL-FCC.

For individuals requiring a license, such as commercial users, you should obtain a license application from your nearest FCC field office.

Contents

Uniden POLARIS.....	2
Included with your POLARIS.....	3
Controls and Indicators.....	4
Installation.....	8
Choosing a Location.....	8
Engine Noise Suppression.....	9
Antenna Considerations.....	9
Antenna Selection and Installation.....	9
Installing the POLARIS.....	10
Operation.....	11
Power On/Off.....	11
Last Channel Memory.....	11
Squelch.....	12
Instant Channel 16/Channel 9 Communications.....	13
Triple Watch.....	13
Manual Tuning.....	14
Weather Channels.....	14
MEM (Entering channel numbers into Memory Scan).....	14
Triple Watch Scan.....	15
Normal Scan.....	15
Triple Watch Alert Scan.....	15
Alert Scan.....	15
Hail.....	16
Hail Volume Adjust.....	16
Weather Alert.....	17
Transmitting.....	19
Setting TX Output.....	19
Distress.....	20
Menu Operation.....	22
Digital Selective Calling (DSC).....	22
Individual.....	22
Group.....	23
All Ships.....	24
Position Request.....	25
Position Send.....	27
Standby.....	28
Call Wait.....	29
Geographical Call.....	30

System.....	31
Contrast.....	31
Lamp Adjust	32
Key Beep	33
LCD Color	34
Setup	35
FIPS	35
User MMSI	39
Group MMSI.....	41
U.I.C	42
Directory.....	43
Auto Channel Switch.....	49
Position Reply	50
CH Tag	52
WHAM.....	55
Alarm Clock.....	58
Time Offset.....	61
Review Channel Memory	63
NMEA Technical Setup	64
Optional Accessories	64
VHF FM Marine Radio Telephone	
Channel and Functions (USA Channels)	65
Channel and Functions (International Channels)	66
Channel and Functions (Canadian Channels).....	67
NWR-SAME Event Code.....	68
Specification	69
Troubleshooting	70
Care and Maintenance	71
Three Year Limited Warranty.....	72

Spanish owner's manual available at www.uniden.com
<http://www.uniden.com/productsupport.cfm?cat=Marine%20Electronics>

El manual para el usuario, en el idioma español, está disponible en www.uniden.com
<http://www.uniden.com/productsupport.cfm?cat=Marine%20Electronics>

Uniden POLARIS

The Uniden **POLARIS** VHF marine radio transceiver has been designed to give you a rugged, reliable instrument that will provide you with years of trouble-free service.

With proper care and maintenance, your Uniden **POLARIS** could outlast your present vessel and serve you well on-board. The full features and flexibility designed into this quality transceiver will prevent it from becoming obsolete regardless of changes in craft or geographic locations.

The technical excellence of the Uniden **POLARIS** is demonstrated by the multiplicity of uses for which it has been found acceptable by the U.S. Federal Communications Commission. The Uniden **POLARIS** is acceptable for compulsory use on "party boats", for use on vessels subject to the Great Lakes Radio Agreement or bridge-to-bridge requirements, for general pleasure and commercial vessels, and certain land stations in marine service.

The Uniden **POLARIS** is of all solid-state design with conservatively rated, rugged components and materials compatible with the marine environment. The transceiver utilizes a number of gaskets, sealing rings, waterproof membranes, and other sealants to effect a waterproof housing for protection of the electronics. The Uniden **POLARIS** Radio meets the most stringent JIS7 waterproof specification. The unit may be mounted in any number of convenient locations on your vessel by utilizing the optional universal mounting bracket (FMB321).

You are encouraged to thoroughly read the rest of this Operating Guide to acquaint yourself with the characteristics and operation of your transceiver so that you can contribute to the longevity of your investment.

Keep your receipt as proof-of-purchase in case warranty service is required.

Features, specifications, and availability of optional accessories are all subject to change without notice.

Note: **POLARIS** meets JIS7 requirements.

The color of your **POLARIS** may vary.

Included with your POLARIS

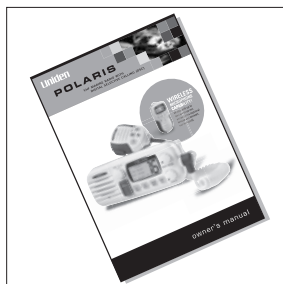

POLARIS Owner's Manual

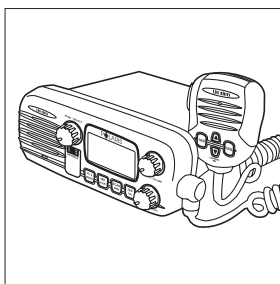

POLARIS Radio

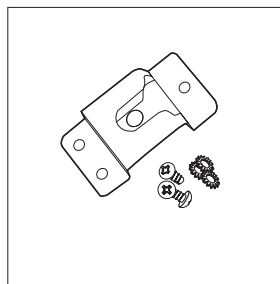

Microphone Hanger
and Screws

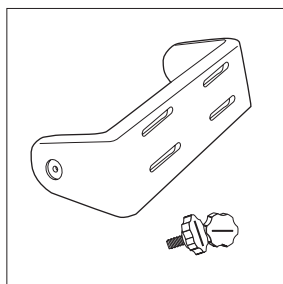

Mounting Bracket
and Knobs

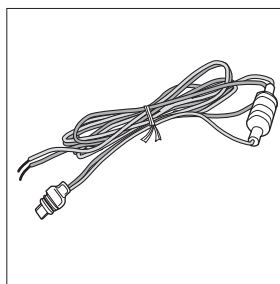

DC Cord

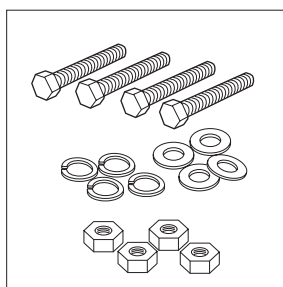

Mounting Hardware

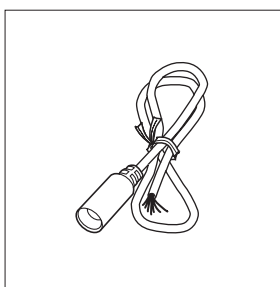

Accessory Cable

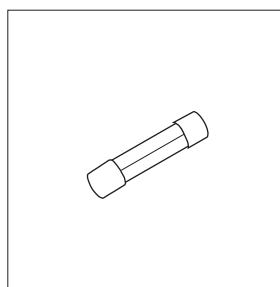

Spare Fuse
250V 6A

Controls and Indicators

Front panel/Microphone

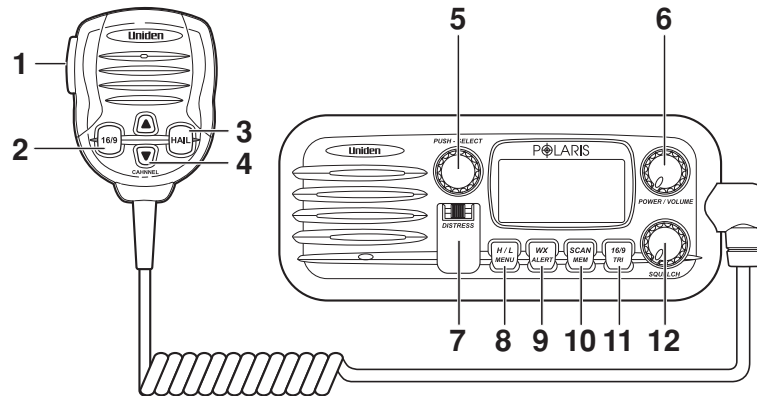

1. **PTT Switch** - Press to transmit and release to receive.
2. **16/9** - Instantly change to Channel 16, Channel 9 or current channel.
3. **HAIL** - Use as a public address system and two way voice communication.
4. **CHANNEL/▲/▼** - Change the channel number up/down. These buttons are used to adjust the volume for Hail mode and to move the cursor in Menu mode.
5. **PUSH/SELECT** - This is used to manually select the desired Communication Channel (01-28 and 60-88), or Weather Channel (0-9). In the Menu mode this is used to select the menu options. It also changes to display the GPS mode. It is used to adjust the volume for the HAIL mode.
6. **POWER/VOLUME** (On/Off/Volume) - Turns the unit On or Off and adjusts the speaker volume.
7. **DISTRESS** - Used to send a signal of distress in case of emergency.
8. **H/L/MENU** - Change transmit power HI/LO and select Menu mode. Press this key to change the transmit power to either High or Low. Press and hold this key for 2 seconds to enter the Menu mode.
9. **WX/ALERT** - Select Weather channel and Weather Alert mode. Press this key to listen to active NOAA Weather channels. Press and hold this key for 2 seconds to place the radio into the Weather Alert mode.
10. **SCAN/MEM** - Select Scan mode and setup Memory channels. Press this key to activate the Scan operation. Press and hold this key for 2 seconds to place a channel into Scan Memory or remove a channel from Scan Memory.
11. **16/9/TRI** - Access channel 16/9, and setup Triple Watch function. Instantly change to Channel 16, Channel 9 or current channel. Press and hold the key for 2 seconds to turn Triple Watch On/Off.
12. **SQUELCH** - Eliminate background noise when a signal is not being received.

Rear Panel Connectors

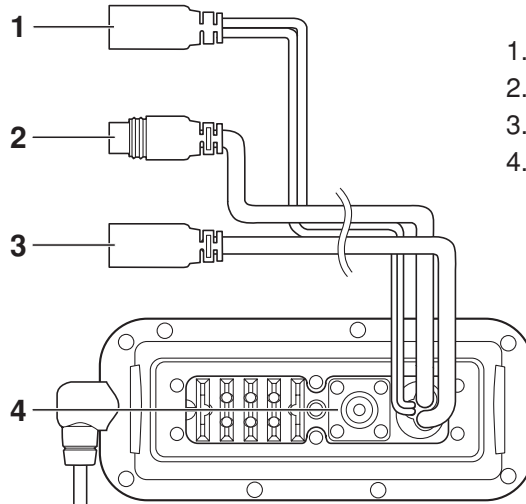

1. DC Jack
2. ACC Connector
3. Remote Connector
4. Antenna Connector

ACC Connector

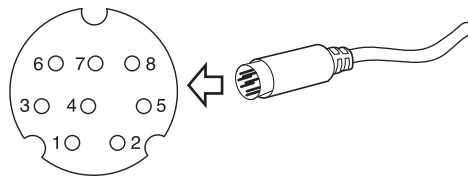



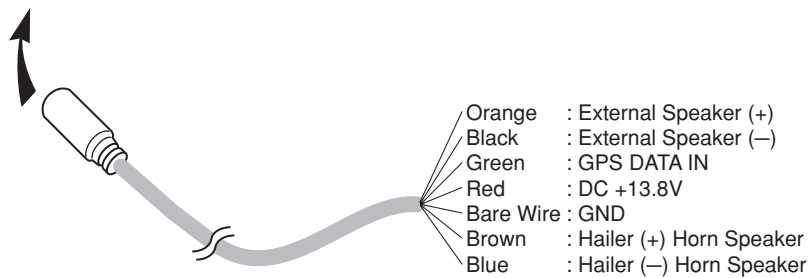

Pin number	Color	Signal
1	ORG	External Speaker (+)
2	RED	DC +13.8V
3	BRN	Hailer (+) Horn Speaker
4	GRN	GPS DATA IN
5		
6	BAR	GND
7	BLK	External Speaker (-)
8	BLU	Hailer (-) Horn Speaker

To POLARIS

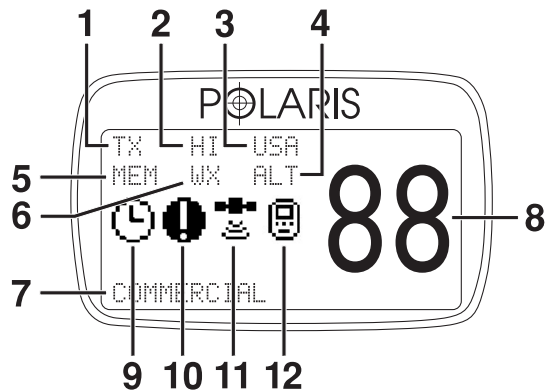

Note: DC13.8V and GND are for GPS ANT.





1. **TX** (Transmit) - Indicates transmitting.
TRI (Triple Watch) - Indicates Triple Watch Mode is in effect.
2. **HI (High)** - Indicates transmit output is 25 Watts.
LO (Low) - Indicates transmit output is 1 Watt.
3. **USA** - Indicates US Channel Mode.
CAN - Indicates Canada Channel Mode.
INT - Indicates International Channel Mode.
4. **ALT** - Indicates Weather Alert Mode has been activated.
5. **MEM (Memory)** - Indicates Memory Scan Mode status for each channel selected.
6. **WX** - Indicate Weather Channel Mode has been activated.
7. **CH TAG**
8. **Channel Display** - Indicates Channel Number in use.
9.  (**Alarm mark**) - *It appears when the alarm is set.*
10.  (**Exclamation mark**) - *It appears when it receives WX Alert.*
11.  (**GPS mark**) - *It appears while GPS module is receiving the data.*
12.  (**WHAM mark**) - *It appears when it is connected to the control unit of WHAM.*

Note:  This icon appears while the **POLARIS** is in the "data cleaning" mode.

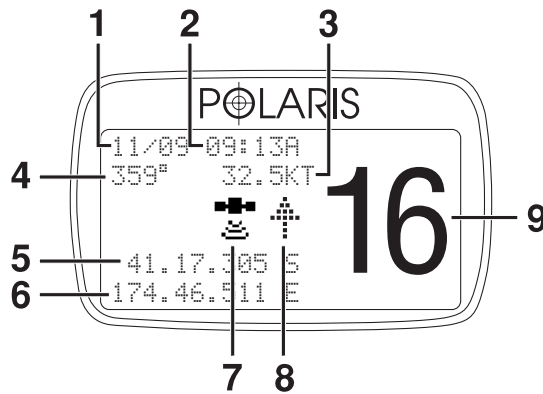
GPS Indicator (External GPS Source Required)



1. **Date**
2. **Time**
3. **Speed Data**
4. **Angle Data - Compass direction**
5. **Latitude**
6. **Longitude**
7.  (GPS mark) - It appears while GPS module is receiving the data.
8. **Direction**
*  - It appears when the ship is not moving.
9. **Channel Display**

 It appears when GPS is connected to the **POLARIS**.

 It appears when GPS is receiving data.

 It appears when the battery voltage is too high.

 It appears when the battery is low.

Installation

Caution: The **POLARIS** will only operate with a nominal **12 volt** negative ground battery system.

It is important to carefully determine the most suitable location for your **POLARIS** on your vessel. Electrical, mechanical, and environmental considerations must all be taken into account. You should select the optimum relationship among these considerations.

Keep in mind the flexibility designed into the **POLARIS** so that you can most conveniently use your radio. Features which should be considered are:

1. The universal mounting bracket may be installed on either the top or bottom of a shelf, on a bulkhead, or for overhead mounting.
2. The REMOTE speaker wires can be used with an auxiliary speaker.
3. All connections are "plug-in" type for easy removal of the radio.
4. Front fire internal speaker allows convenient in-dash mounting using the optional bracket (FMB321).

Choosing a Location

Some important factors to consider in selecting the location for your **POLARIS**.

1. Select a location that is free from spray and splash.
2. Keep the battery leads as short as possible. Direct connection to the battery is most desirable. If direct connection can not be made with the supplied power lead, any extension should be made with #10 AWG wire. Long extensions should use larger gauge wire.
3. Keep the antenna lead as short as possible. Long antenna leads can cause substantial loss of performance for both receiving and transmitting.
4. Locate your antenna as high as possible and clear from metal objects. The reliable range of coverage is a direct function of the antenna height.
5. Select a location that allows free air flow around the heat sink on the rear of the radio.
6. Select a location well away from the ship's compass. Auxiliary speakers also should be located away from the compass.

Engine Noise Suppression

Interference from the noise generated by the electrical systems of engines is sometimes a problem with radios. The **POLARIS** has been designed to be essentially impervious to ignition noise and alternator noise. However, in some installations it may be necessary to take measures to further reduce the effect of noise interference. All DC battery wires, antenna lead, and accessory cables should be routed away from the engine and engine compartment, and from power cabling carrying high currents.

In severe cases of noise interference, it may be necessary to install a noise suppression kit. Contact your Uniden Dealer for more information.

Antenna Considerations

A variety of antennas are available from a number of quality suppliers. It is recommended you draw upon the advice of your Uniden dealer in determining a suitable antenna for your vessel and range requirements.

In general, communication range is increased by using a high-gain antenna placed as high as possible above the water line. Antennas should be located away from metal objects. Antennas should not have excessively long coaxial feed cables.

Antenna Selection and Installation

Your Uniden **POLARIS** radio has been designed to accommodate all of the popular marine VHF antennas. However, the selection and the installation of the antenna is the responsibility of the user or installer.

The FCC has determined that excessive radiation poses a health risk to people near radio transmitting antennas. Therefore, the antenna used with this radio should be installed using the following guidelines to insure a suitable distance between the antenna and persons close by.

Small whip antennas (3 dB) or smaller should be installed keeping at least three feet separation distance between the radiating element and people.

Larger antennas (6 dB or 9 dB) should be installed keeping at least a six foot separation distance.

No person should touch the antenna or come into the separation distance when the radio is transmitting.

Installing the POLARIS

After you have carefully considered the various factors affecting your choice of location, position the radio (with the bracket, microphone, power cord, antenna and any auxiliary cables installed) into the selected location to assure there is no interference with the surrounding items. Mark the location of the mounting bracket. Remove the bracket from the radio and use it as a template to mark the holes to be drilled for the mounting hardware. Drill the holes and mount the bracket with hardware compatible with the material of the mounting surface.

Note: *This HEXAGON HEAD BOLT is only for mounting the bracket with hardware. Do not use it for installing the radio in the mounting bracket.*

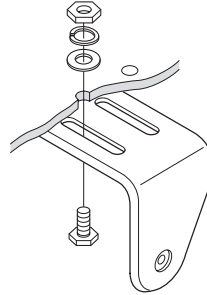

Connect the red wire of the supplied power cord to the positive (+) battery supply. Connect the black wire of the power cord to the negative (-) battery supply. The power cord is equipped with a fuse to protect the radio. Use only a six (6) ampere fast blow fuse for replacement. Connect the power cord to the keyed connector on the power "pigtail".

Connect the antenna and all other auxiliary cables and accessories. Install the radio in the mounting bracket and connect all cables and accessories to the appropriate jacks and connectors.

Note: *Do not use any other mounting knobs than the ones enclosed. Do not insert the knobs without attaching the bracket.*

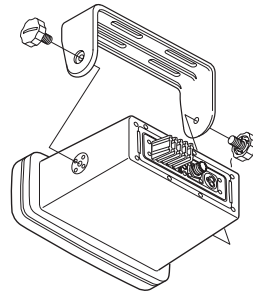

Operation

POWER On/Off

Turn the unit On by rotating the **POWER/VOLUME** control clockwise. Adjust the volume to a comfortable level.

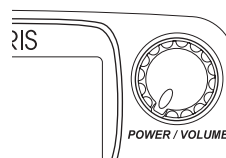

When you turn the unit On, you will hear a beep and the greeting message below appears on the LCD for 2 seconds.



Note: When you turn On the radio, the channel you set last will display on the LCD.

Last Channel Memory

The **POLARIS** memorizes the last channel selected before you turn Off the radio. Example, if you turn Off the **POLARIS** on CH 16, the radio will be on that channel when turned back On.

Note: In order for the last channel to be memorized you must have the radio on that channel for 3 seconds.

SQUELCH

Turn **SQUELCH** fully clockwise. This raises the “Squelch Gate” so high that only very strong signals can get through.

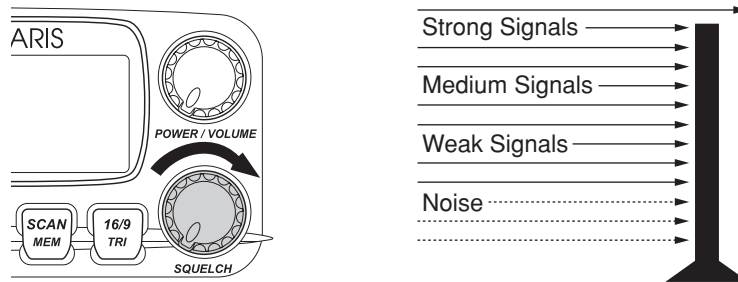

Turn **SQUELCH** fully counterclockwise until you hear a hiss. This lowers the “Squelch Gate” so that everything gets through - noise, weak signals, and strong signals.

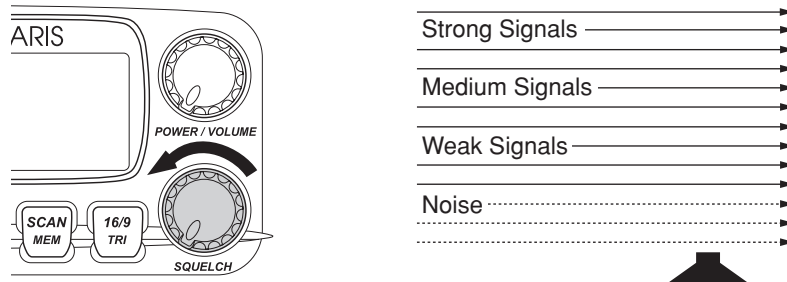

Turn **SQUELCH** back clockwise until the hiss stops. Now the “Squelch Gate” allows only strong signals through.

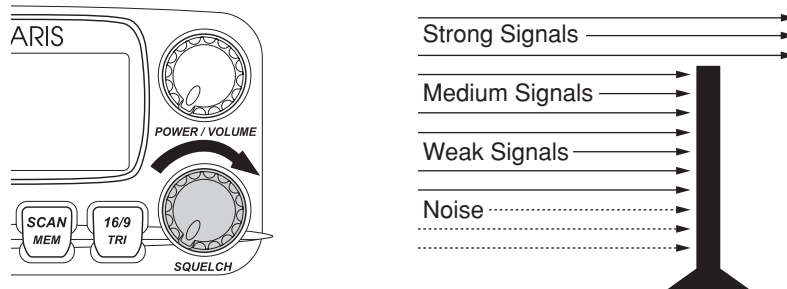

INSTANT CHANNEL 16/CHANNEL 9 COMMUNICATIONS

To access instant Channel 16 or Channel 9 communications, press **16/9/TRI**. You can access Channel 16 instantly while tuned to another channel. Press **16/9/TRI** again to access Channel 9 communications. Press and release **16/9/TRI** a third time to return to the channel selected prior to accessing instant Channel 16/Channel 9 communications. The display will indicate the selected channel.

To cancel Channel 16/Channel 9 communications:

- Press **16/9/TRI** until the previous channel setting appears.

--or--

- Press **WX/ALERT**.

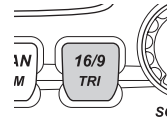

TRIPLE WATCH

Triple Watch monitors Channel 16, Channel 9, and the current Marine Channel or Weather Channel.

To activate Triple Watch, press and hold **16/9/TRI** for 2 seconds. TRI appears on the LCD, indicating Triple Watch mode is in effect. If a signal is received on either Channel 16 or Channel 9, the radio remains on that channel until the signal ends.



Press and hold **16/9/TRI** for 2 seconds to cancel the Triple Watch mode.

Note: While in Triple Watch mode, you can change the currently selected channel using the **PUSH – SELECT** knob. A momentary press of the **16/9/TRI** button interrupts Triple Watch mode and remains on channel 16, or on channel 9 if you press **16/9/TRI** once more. To return to the Triple Watch mode, simply press the button again.

MANUAL TUNING

To manually select a channel, rotate the **PUSH – SELECT knob** clockwise to increase the number or counterclockwise to decrease the number. It also can be changed by ▲ or ▼ on the microphone. Communication channels are located on channel 01-28 and 60-88. Weather channels are located on channels 0-9.

WEATHER CHANNELS

To select Weather Channels 0-9, press **WX/ALERT**. The radio will go to the last selected Weather Channel. Press ▲ or ▼ on the microphone to select a different Weather Channel. It also can be changed by the **PUSH – SELECT knob** on the base.

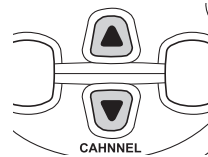

To exit from Weather Channel:

- Press **WX/ALERT**. The radio returns to the previous Marine channel.

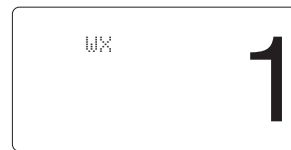

MEM (Entering channel numbers into Memory Scan)

You can enter channels into Memory Scan for instant scanning at any time. When a channel is selected for Memory Scan, **MEM** appears on the LCD display.

To enter a channel into Memory Scan, select the channel you want to store by rotating the **PUSH – SELECT knob**, and then press and hold **SCAN/MEM** for 2 seconds. The channel is stored in Memory Scan and **MEM** appears on the LCD display.



To cancel the channel in Memory, press and hold **SCAN/MEM** for 2 seconds and the **MEM** icon disappears.

Note: *The Memory channel can be set independently in 3 regional modes (USA, INT, and CAN). You cannot use this feature in WX mode or for channel 70.*

Triple Watch Scan

To turn Triple Watch Scan On, press and hold **16/9/TRI** for 2 seconds. Although the current channel is scanned, PRI 16 CH and PRI 9 CH are scanned every 2 seconds. Then "TRI" appears.

Normal Scan

To turn Normal Scan On, press **SCAN/MEM**, and then press and hold **16/9/TRI** for 2 seconds. Although Memory CH is scanned, PRI 16 CH and PRI 9 CH are not.

Triple Watch Alert Scan

To turn Triple Watch Alert Scan On, press and hold **WX/ALERT** for 2 seconds while in Triple Watch mode. Although Memory CH is scanned, MRN 16 CH and MRN 9 CH are scanned every 2 seconds, and WX CH is scanned every 7 seconds. "TRI" and "ALT" appear on the LCD.

Alert Scan

To turn Alert Scan On, press and hold **WX/ALERT** for 2 seconds. Although Memory CH is scanned, WX CH is scanned every 7 seconds.

Hail

To access the Hail mode, press **HAIL** on the microphone. "HA" appears on the display. Press and hold the **PTT** switch on the microphone, hold the microphone approximately two inches away from your mouth, and speak clearly in a normal voice. To cancel Hail mode, press **HAIL** on the microphone.



Hail Volume Adjust

While you are in Hail mode, you can adjust the out going volume by pressing ▲/▼ on the microphone, or by rotating the **PUSH – SELECT** knob on the **POLARIS**. The incoming volume is adjusted by using the **POWER/VOLUME** knob.

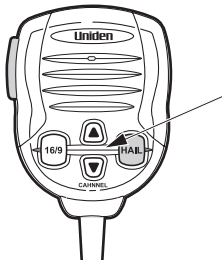

Note: When purchasing a Hailer horn for the **POLARIS** radio please consider these required specifications.

- 17 W (Nominal)
- 10 W (minimum)
- 4 Ω Load (impedance)

* *RE-ENTRANT* feature may not work for all the models.

Weather Alert

The traditional weather feature receive's weather broadcast (usually within a 50-mile radius) then sound an alarm of any emergency code which was transmitted along with the broadcast. This means that people who live outside an affected area are often alerted even when their area is not affected, causing many of them to ignore potentially real emergency/weather warnings that can save lives.

In 1994, the National Oceanic and Atmospheric Administration (NOAA) began broadcasting coded signals called FIPS (Federal Information Processing System) codes along with their standard weather broadcasts from stations in your area. These codes identify an emergency and the specific geographic area (such as a country) affected by the emergency.

The **POLARIS** was developed with the SAME (Specific Area Message Encoding) technology. This allows your radio to receive, interpret, and display the information about the codes so you can determine if the emergency might affect your area.

Each FIPS code identifies a specific geographic area (defined by the National Weather Service), so your radio sounds an alert only when an emergency/weather emergency is declared in those locations. This helps you more efficiently track the emergency/weather conditions in and around your area.

The Weather Alert mode can be activated to alert you of dangerous weather. When Weather Alert is turned On, and a warning signal is received, an emergency siren will sound at full volume, regardless of the volume setting. When the signal stops, you will hear the active weather channel broadcast at the normal volume.

Note: See *SETUP* mode to program up to 30 FIPS codes.

The **ALT** icon indicates the Weather Alert mode is activated. To activate the Weather Alert mode:

1. Press and hold **WX/ALERT** for 2 seconds if **WX/ALERT** is Off, it is changed to **WX/ALERT On** and the **ALT** icon appears.



2. If the radio receives a 1050Hz tone, the **!** (Exclamation mark) and the **ALT** icon will blink every other second.

In the area where **SAME** is broadcasted, the following is displayed.



3. When a **WX/ALERT** signal is received, all other functions are canceled and the radio remains on the selected weather channel.

When the radio is in Scan mode, scanning the weather channel every 7 seconds, the **SAME** signal is not decoded. To decode the **SAME** signal, the radio should be on an active weather channel. In order to stop the alert press any key. If you press any key once more, the alert icon disappears.



TRANSMITTING

The **POLARIS** transmits on fifty-five marine frequencies and receives on eighty marine frequencies. Channel 70 of the USA, International, and Canadian frequencies, and channel 15, of the USA frequencies, and WX CH – are for receiving only. The **POLARIS** transmits on channel 70 when sending DSC information. Your radio will not transmit on these channels. For your reference, a listing of all the available marine channels are located on pages 67 - 69.

SETTING TX OUTPUT

Caution: *It is important to remember to use the LO position in port or for short range communications.*

1. When you turn the **POLARIS** On for the first time, the unit is automatically set to transmit at 25 watts (HI).



2. Press **H/L/MENU** to change the transmitter output to 1 watt (LO).



3. Press **H/L/MENU** again to change back to 25 watts (HI).



Note: *Each time the H/L/MENU is pressed a short tone sounds. CH13 is set as 1 watt (LO) channel. When the channel is set as LO power channel, you can transmit at 25 watts (HI) by pressing and holding H/L/MENU during the call. LO power channels are 13 and 67 for USA, and 13, 15, 17, and 20 for CAN.*

DISTRESS

Note: You must set the user MMSI in order to send a Distress call. Please see page 40 to set the MMSI.

This feature will allow you to transmit a Distress call.

1. In order to transmit a Distress call, press and hold **DISTRESS** for 5 seconds. Then, the following screen appears and select **SEND** or **CANCEL**. If you select **CANCEL**, the display returns to the channel display screen.
2. Press the **PUSH – SELECT** knob to send.
3. The Distress call is transmitted and it waits for about 210 - 270 seconds. This is continued internally. After the Distress call has been sent, the Distress alert will sound every other second, and it also "shadow-watches" for a transmission between CH16 and CH70 until an acknowledgment signal is received from the Coast Guard shore station.
4. To cancel the Distress call, press the **PUSH – SELECT** knob.
5. When the **POLARIS** receives a Distress call, the following screen appears. If an acknowledgment is not received, the Distress call is repeated until an acknowledgment is received from the Coast Guard shore station.

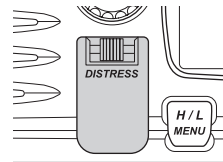

```
DISTRESS
70
→SEND
CANCEL
```

```
DISTRESS ACK
16
WAITING
→CANCEL
```

```
DISTRESS
06/15 10:30A
KENT NEWMAN
FIRE
70.00.000 N
120.00.000 W
16
```

```
DISTRESS
06/15 10:30A
PAUL HUBER
FIRE
70.40.000 N
150.00.000 E
16
```

```
DISTRESS
---/-- ---:--
135792468
UNDESIGNATED
NO POSITION
16
```

Note: If the **POLARIS** receives a Distress call, it will be displayed on the LCD display. An emergency alert will sound. The name will be displayed if it is the name registered in the directory. Otherwise, sender's MMSI is displayed. Latitude, longitude, and time information will also be displayed if the GPS module is carried in the vessel that transmitted a DSC Distress call.

MARINE DISTRESS PROCEDURE

Speak slowly – clearly – calmly.

1. Make sure your radio is On.
2. Tune to Channel 16.
3. Press the PTT button on the microphone and say: "MAYDAY – MAYDAY – MAYDAY."
4. Give your ship ID.
5. Say "MAYDAY [your ship name]."
6. Give your location: (what navigational aids or landmarks are near).
7. State the nature of your distress.
8. Give the number of persons aboard and the conditions of any injured.
9. Estimate present seaworthiness of your vessel.
10. Give a brief description of your vessel (meters, type, color, hull).
11. Say: "I will be listening on Channel 16".
12. End message by saying "THIS IS [your ship name or call sign] OVER."
13. Release the PTT button and listen. Someone should answer. If not, repeat call, beginning at Item 3 above.

Menu Operation

1. DIGITAL SELECTIVE CALLING (DSC)

Digital Selective Calling is a process of establishing a radio call, it has been chosen by the International Maritime Organization (IMO) as an international standard for establishing VHF, MF and HF radio calls. Digital Selective Calling has also been selected as part of the Global Maritime Distress and Safety System (GMDSS).

This service will let you instantly send a Distress call with GPS position (when optional GPS receiver is connected to the **POLARIS**) to the US Coast Guard and other vessels within range of the transmission. DSC will also let you initiate or receive distress, urgency, safety, position information and routine calls to or from another vessel outfitted with a DSC transceiver.

See the directory section for instructions on how to setup the directory of names.

Note: POS. SEND, ALARM CLOCK, and TIME OFFSET will not be displayed if the GPS is not connected.

1. Press and hold **H/L/MENU** for 2 seconds.
2. Press the **PUSH – SELECT** knob to select **DSC CALL**.

```

→DSC CALL
SYSTEM
SETUP
REV. CH. MEM
EXIT
68
  
```

1-A. INDIVIDUAL

1. Press and hold **H/L/MENU** for 2 seconds.
2. Press the **PUSH – SELECT** knob at **DSC CALL**, the **DSC CALL** menu appears.
3. Press the **PUSH – SELECT** knob, and the individual directory appears.

```

HI CAN
68
SHIP-SHIP
  
```

```

→DSC CALL
SYSTEM
SETUP
REV. CH. MEM
EXIT
68
  
```

```

→INDIVIDUAL
GROUP
ALL SHIPS
POS. REQUEST
POS. SEND
STANDBY
68
  
```

4. Rotate the **PUSH – SELECT** knob to select the individual you want to contact, and press the **PUSH – SELECT** knob.

```
→JUNE BRAWLEY
KENT NEWMAN
PAUL HUBER
EXIT
68
```

5. Press the **PUSH – SELECT** knob to transmit the individual DSC signal.

```
INDIVIDUAL
KENT NEWMAN
012345678
68
→SEND
CANCEL
```

6. When you receive the individual acknowledgment successfully, the following screen appears, and both radios tune to the previously selected channel. You are now ready to transmit on that channel.

```
INDVL ACK
KENT NEWMAN
012345678
COMPLETED
68
```

or

When the called radio has been set to standby mode, the following screen appears.

```
INDVL ACK
KENT NEWMAN
012345678
UNATTENDED
68
```

Note: *If there is not any data registered in the directory you cannot proceed to the 3rd step. See the SETUP section for directory setup instructions.
Select an open (unused) working channel first, then make the call. After the acknowledgment, both radios tune to the previously selected channel.*

1-B. GROUP

1. Press and hold **H/L/MENU** for 2 seconds.
2. Press the **PUSH – SELECT** knob at **DSC CALL**, the DSC CALL menu appears.

```
HI CAN
68
SHIP-SHIP
```

```
→DSC CALL
SYSTEM
SETUP
REV. CH. MEM
EXIT
68
```

3. Rotate the **PUSH – SELECT** knob to select **GROUP**.

```
INDIVIDUAL
→GROUP
ALL SHIPS
POS. REQUEST
POS. SEND
STANDBY
68
```

4. Press the **PUSH – SELECT** knob, and the MMSI code appears, you can now call the group members. Press the **PUSH – SELECT** knob to select **SEND** and the **POLARIS** returns to the channel display screen.

```
GROUP
123456789
68
→SEND
CANCEL
```

```
HI CAN
68
SHIP-SHIP
```

1-C. ALL SHIPS

1. Press and hold **H/L/MENU** for 2 seconds.
2. Press the **PUSH – SELECT** knob at **DSC CALL**, the DSC CALL menu appears.
3. Rotate the **PUSH – SELECT** knob to select **ALL SHIPS**.
4. Press the **PUSH – SELECT** knob, and the ALL SHIPS directory appears.

```
HI CAN
68
SHIP-SHIP
```

```
→DSC CALL
SYSTEM
SETUP
REV. CH. MEM
EXIT
68
```

```
INDIVIDUAL
GROUP
→ALL SHIPS
POS. REQUEST
POS. SEND
STANDBY
68
```

5. Rotate the **PUSH – SELECT** knob to select the nature of your call (URGENCY, SAFETY, ROUTINE).

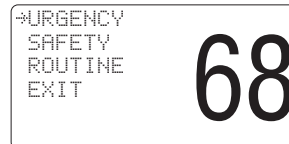

Note: ROUTINE calls tune to the previously selected channel.

6. Press the **PUSH – SELECT** knob to transmit the ALL SHIPS DSC signal.

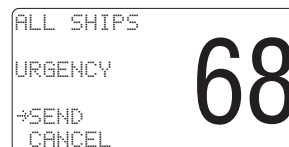

7. When sending either an URGENCY or SAFETY message, all radios will automatically move to channel 70 until all of the data is received.

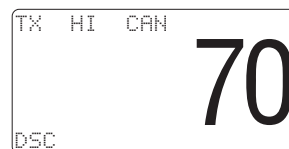

8. After selecting URGENCY or SAFETY ALL SHIPS call is transmitted, the POLARIS will switch to Channel 16. You should wait a few minutes before transmitting the ALL SHIPS call information.



1-D. POSITION REQUEST

This radio has the ability to request the position of an individual vessel that is registered in the DIRECTORY.

1. Press and hold **H/L/MENU** for 2 seconds.



2. Press the **PUSH – SELECT** knob at DSC CALL, the DSC CALL menu appears.

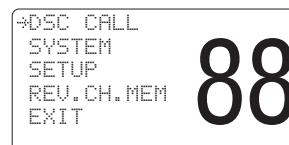

3. Rotate the **PUSH – SELECT** knob to select **POS. REQUEST**.

```
INDIVIDUAL
GROUP
ALL SHIPS
→POS. REQUEST 88
POS. SEND
STANDBY
```

4. Press the **PUSH – SELECT** knob, and the individual directory appears.
5. Rotate the **PUSH – SELECT** knob to select the name to request the individual's position.

```
*KENT NEWMAN
PAUL HUBER
JUNE BRAWLEY 88
EXIT
```

6. Press the **PUSH – SELECT** knob, the following screen appears. Confirm if the name and address is correct. Press the **PUSH – SELECT** knob to select **SEND**.

```
POS. REQUEST
KENT NEWMAN
654321000 88
→SEND
CANCEL
```

```
POS. REPLY
KENT NEWMAN
654321000 70
WAITING
→CANCEL
```

7. If the **POLARIS** does not detect an acknowledgment, the following screen appears.

```
POS. REQUEST
KENT NEWMAN
654321000 88
→SEND
CANCEL
```

8. When the called vessel sends the position information, the following screen appears.

```
POS. REPLY
06/15 03:00P 88
KENT NEWMAN
70.00.000 N
110.00.000 E
```

Note: *The requested radio must have the ability to transmit the position information (such as having a **POLARIS** radio).*

1-E. POSITION SEND

This radio has the ability to send the position of your vessel to another vessel using a VHF marine radio equipped with DSC.

Note: Position send is only available when it is connected to the GPS.

1. Press and hold **H/L/MENU** for 2 seconds.



2. Press the **PUSH – SELECT** knob at DSC CALL, the DSC CALL menu appears.

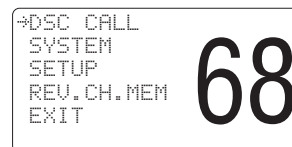

3. Rotate the **PUSH – SELECT** knob to select POS. SEND.

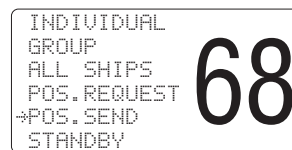

4. Press the **PUSH – SELECT** knob, and the individual directory appears.
5. Rotate the **PUSH – SELECT** knob to select the name to send your position information.

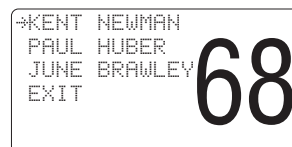

6. Press the **PUSH – SELECT** knob, the following screen appears. Confirm if the name and address is correct. Press the **PUSH – SELECT** knob to select SEND.

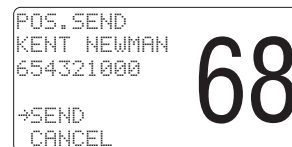

7. When the calling radio receives an acknowledgment, the following screen appears.

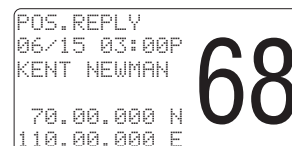

1-F. STANDBY

The DSC STANDBY function allows the **POLARIS** to answer DSC calls with the UNATTENDED message and record the calls for response at another time. When you set the **POLARIS** to DSC STANDBY mode, voice traffic may still be active on any chosen channel.

1. Press and hold **H/L/MENU** for 2 seconds.



2. Press the **PUSH – SELECT** knob at **DSC CALL**, the DSC CALL menu appears.

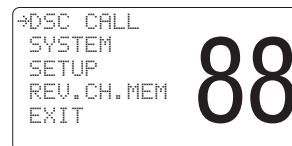

3. Rotate the **PUSH – SELECT** knob to select **STANDBY**.

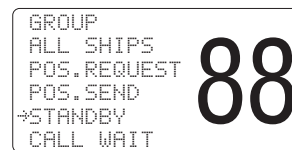

4. Press the **PUSH – SELECT** knob, and the **STANDBY** directory appears.



5. When an individual DSC call is received, the radio will respond with the **UNATTENDED** message when an operator cannot answer the call. The DSC call will be recorded into the radio's Call Waiting directory.

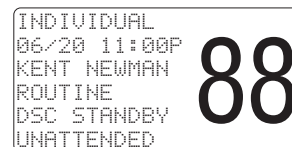

Note: If you press a key on the radio or the PTT, this feature will be canceled.

1-G. CALL WAIT

The DSC Call Waiting directory records 10 received distress calls, and records 20 individual calls that are received and not answered within 5 minutes or while the radio is set to DSC Standby. Calls will be recorded while you are busy with other communications as long as the transmitter is not keyed at the time of the call. If the call is answered within 5 minutes the call will not be recorded. When a call is recorded, a message appears.

1. Press and hold **H/L/MENU** for 2 seconds.



2. Press the **PUSH – SELECT** at **DSC CALL**, the DSC CALL menu appears.

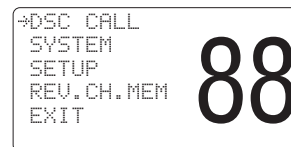

3. Rotate the **PUSH – SELECT** knob to select **CALL WAIT**.

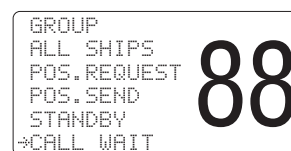

4. Press the **PUSH – SELECT** knob, and the **CALL WAIT** directory appears.
5. Rotate the **PUSH – SELECT** knob to select the options you want to view.

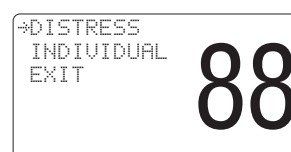

Note: If a call has not been logged, the **POLARIS** will beep and you will not be able to proceed to the next step.

6. Press the **PUSH – SELECT** knob.
7. Rotate the **PUSH – SELECT** knob to select the information.

```

→KENT NEWMAN
PAUL HUBER
JUNE BRAWLEY
EXIT
88

```

8. Press the **PUSH – SELECT** knob to get further information about the call received.
- If a DISTRESS call is received in Call Wait, the following display appears.

```

DISTRESS
06/15 10:30A
KENT NEWMAN
FIRE
70.40.000 N
150.00.000 E
70

```

If an INDIVIDUAL call is received in Call Wait, the following display appears. At this point, you can call back any of the radios in the log.

```

INDIVIDUAL
06/20 11:00P
KENT NEWMAN
ROUTINE
→SEND
CANCEL
88

```

Geographical Call

This function can receive the electric wave transmitted towards the ship that is present in the domain specified from the call side.

Note: *The POLARIS receives geographical calls only, sending geographical calls is not available in the POLARIS radio. It also indicates the time when the geographical call is received.*

2. SYSTEM

2-A. CONTRAST

1. Press and hold **H/L/MENU** for 2 seconds.
2. Press the **PUSH – SELECT** knob at **SYSTEM**, the SYSTEM menu appears.
3. Press the **PUSH – SELECT** knob at **CONTRAST**, and the following screen appears.
4. Rotate the **PUSH – SELECT** knob counterclockwise to increase the background brightness level. (Default is set at 6).
5. When you find the most favorable brightness, press the **PUSH – SELECT** knob and the **POLARIS** returns to the channel display screen.

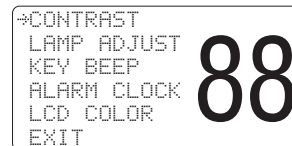
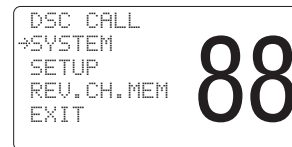

Note: There are 10 contrast levels.

2-B. LAMP ADJUST

1. Press and hold **H/L/MENU** for 2 seconds.



2. Press the **PUSH – SELECT** knob at **SYSTEM**, the SYSTEM menu appears.

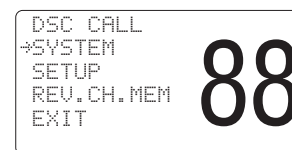

3. Rotate the **PUSH – SELECT** knob to select **LAMP ADJUST**.

4. Press the **PUSH – SELECT** knob, and the following screen appears.

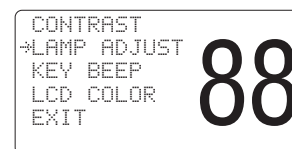

5. Rotate the **PUSH – SELECT** knob to select the backlight brightness level. (Default is set to medium).

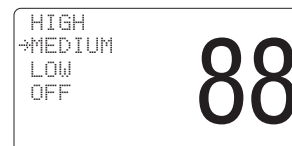

6. When you find the most favorable brightness, press the **PUSH – SELECT** knob and the **POLARIS** returns to the channel display screen.



2-C. KEY BEEP

1. Press and hold **H/L/MENU** for 2 seconds.
2. Press the **PUSH – SELECT** knob at **SYSTEM**, the **SYSTEM** menu appears.
3. Rotate the **PUSH – SELECT** knob to select **KEY BEEP**.
4. Press the **PUSH – SELECT** knob, and the following screen appears.
5. Rotate the **PUSH – SELECT** knob clockwise to increase the volume level, or counterclockwise to decrease the volume level.
6. When you find the most favorable volume, press the **PUSH – SELECT** knob and the **POLARIS** returns to the channel display screen.

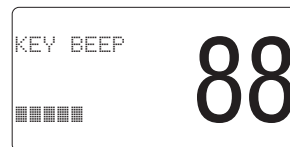
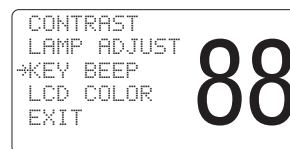
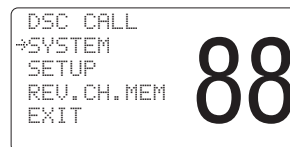

Note: There are 10 volume levels.

2-D. LCD COLOR

1. Press and hold **H/L/MENU** for 2 seconds.



2. Press the **PUSH – SELECT** knob at **SYSTEM**, the **SYSTEM** menu appears.

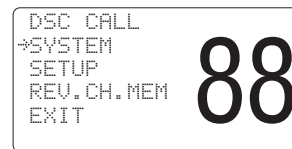

3. Rotate the **PUSH – SELECT** knob to select **LCD COLOR**. Press the **PUSH – SELECT** knob, and the following screen appears.

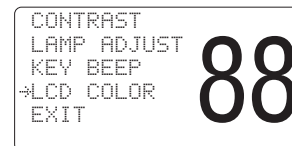

4. Rotate the **PUSH – SELECT** knob to select the color (green or red). (Default is set as green).



5. When you find the most favorable color, press the **PUSH – SELECT** knob and the **POLARIS** returns to the channel display screen.



Note: Only changes the display color. The keys will stay green.

3. SETUP

3-A. FIPS

The 6-digit Federal Information Processing System (FIPS) code established by the National Weather Service (NWS) identifies geographic areas in the United States. Programming FIPS codes are necessary to receive SAME alerts about weather occurring in a particular area. To obtain the FIPS code for a particular area contact the NWS toll free at 1-888-NWR-SAME (1-888-697-7263).

Or visit their website: <http://www.nws.noaa.gov/nwr/indexnw.htm>.

A list of event codes are located on page 70.

To set FIPS code

1. Press and hold **H/L/MENU** for 2 seconds.



2. Press the **PUSH – SELECT** knob at **SETUP**, the SETUP menu appears.

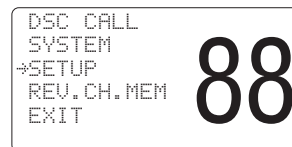

3. Press the **PUSH – SELECT** knob.



3-A-1. NEW

If you select NEW

1. Press and hold **H/L/MENU** for 2 seconds.
2. Press the **PUSH – SELECT** knob at **SETUP**, the **SETUP** menu appears.
3. Press the **PUSH – SELECT** knob at **FIPS**.
4. Press the **PUSH – SELECT** knob at **NEW**, the following screen appears.
5. You can now enter the new FIPS code. Rotate the **PUSH – SELECT** knob clockwise to increase the number, counterclockwise to decrease. The number will be entered when the **PUSH – SELECT** knob is pressed, and the blinking digit moves to the right. When you finished entering the last digit, the following confirmation screen appears.
6. Press the **PUSH – SELECT** knob and the **POLARIS** returns to the following screen.

```

HI CAN
MEM
88
TELEPHONE

```

```

DSC CALL
SYSTEM
→SETUP
REV. CH. MEM
EXIT
88

```

```

→FIPS
USER MMSI
GROUP MMSI
U. I. C.
DIRECTORY
AUTO. CH. SW
88

```

```

→NEW
00.101000
01.101010
EXIT
88

```

```

FIPS CODE
000000
88

```

```

FIPS CODE
502200
→YES
NO
88

```

```

→NEW
00.101000
01.101010
02.501100
EXIT
88

```

3-A-2. EDIT**If you select a number to EDIT.**

1. Press and hold **H/L/MENU** for 2 seconds.

```

HI CAN
MEM      88
TELEPHONE

```

2. Press the **PUSH – SELECT** knob at **SETUP**, the **SETUP** menu appears.

```

DSC CALL
SYSTEM
→SETUP  88
REV. CH. MEM
EXIT

```

3. Press the **PUSH – SELECT** knob at **FIPS**.

```

→FIPS
USER MMSI  88
GROUP MMSI
U. I. C.
DIRECTORY
AUTO. CH. SW

```

4. Press the **PUSH – SELECT** knob at the code that you want to edit.

```

→NEW
00.101000  88
01.101010
02.502200
EXIT

```

5. Press the **PUSH – SELECT** knob at **EDIT**, the following screen appears.

```

→EDIT
DELETE
EXIT  88

```

6. You can now edit the **FIPS** code. Rotate the **PUSH – SELECT** knob clockwise to increase the number, counterclockwise to decrease. The number will be entered when the **PUSH – SELECT** knob is pressed, and the blinking digit moves to the right.

```

FIPS CODE
→01100  88

```

- When you finished editing the last digit, the following confirmation screen appears.



- Press the **PUSH – SELECT** knob and the **POLARIS** returns to the following screen.

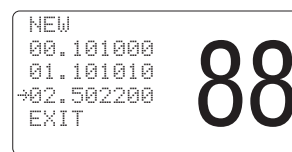

3-A-3. DELETE

If you select DELETE

- Press and hold **H/L/MENU** for 2 seconds.

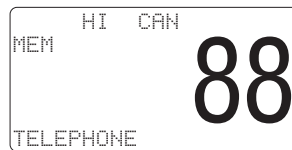

- Press the **PUSH – SELECT** knob at **SETUP**, the **SETUP** menu appears.

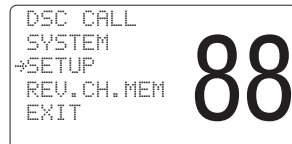

- Press the **PUSH – SELECT** knob at **FIPS**.

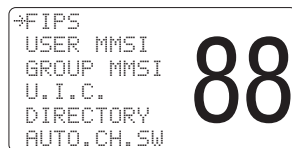

4. Press the **PUSH – SELECT** knob at the code that you want to delete.

```
NEW
00.101000
01.101010
→02.501100
EXIT
```



5. Press the **PUSH – SELECT** knob at **DELETE**, the following screen appears.

```
EDIT
→DELETE
EXIT
```



```
DELETE
501100

→YES
NO
```



6. Press the **PUSH – SELECT** knob and the **POLARIS** returns to the following screen.

```
NEW
00.101000
01.101010
→EXIT
```



3-B. USER MMSI

Federal MMSI's are issued by the National Telecommunications and Information Administration. Non-Federal MMSI's are issued by the Federal Communications Commission (FCC). You will need to obtain a nine digit MMSI number and program it into the **POLARIS**. The information obtained from the application is useful to the U.S. Coast Guard to help in search and rescue operations. To obtain an MMSI number, contact your authorized Uniden dealer or visit one of the following websites: <http://wireless.fcc.gov/marine/ftsht14.html>, www.boatus.com/mmsi/, or www.maritel.usa.com/r-mmsi.htm

This portion of the SETUP menu will allow you to program an MMSI, (Maritime Mobile Service Identity) for sending and receiving DSC calls.

To set USER MMSI code

1. Press and hold **H/L/MENU** for 2 seconds.
2. Press the **PUSH – SELECT** knob at **SETUP**, the **SETUP** menu appears.
3. Rotate the **PUSH – SELECT** knob to select **USER MMSI**.
4. Press the **PUSH – SELECT** knob, the following screen appears.
5. You can now enter the **USER MMSI** code. Rotate the **PUSH – SELECT** knob clockwise to increase the number, counterclockwise to decrease. The number will be entered when the **PUSH – SELECT** knob is pressed, and the blinking digit moves to the right.
6. After the final digit is entered, the confirmation screen appears. Press the **PUSH – SELECT** knob.

```

HI CAN
MEM      88
TELEPHONE

```

```

DSC CALL
SYSTEM
→SETUP  88
REV. CH. MEM
EXIT

```

```

FIPS
→USER MMSI 88
GROUP MMSI
U. I. C.
DIRECTORY
AUTO. CH. SW

```

```

USER MMSI
-00000000 88

```

```

USER MMSI
685749638 ← 88

```

```

USER MMSI
685749638
→YES    88
NO

```

```

ERROR TOO
MANY ENTRIES 88
PRESS
MENU KEY

```

Note: You can only program your **POLARIS** twice with an **MMSI** number. After that, send your **POLARIS** to Uniden for factory service.

3-C. GROUP MMSI

1. Press and hold **H/L/MENU** for 2 seconds.
2. Press the **PUSH – SELECT** knob at **SETUP**, the **SETUP** menu appears.
3. Rotate the **PUSH – SELECT** knob to select **GROUP MMSI**.
4. Press the **PUSH – SELECT** knob, and the following screen appears.
5. You can now enter the **GROUP MMSI** code. Rotate the **PUSH – SELECT** knob clockwise to increase the number, counterclockwise to decrease. The number will be entered when the **PUSH – SELECT** knob is pressed, and the blinking digit moves to the right.
6. After the final digit is entered, a confirmation screen appears. Press the **PUSH – SELECT** knob and the **POLARIS** returns to the following screen.

```

HI CAN
MEM
88
TELEPHONE

```

```

DSC CALL
SYSTEM
→SETUP
REV. CH. MEM
EXIT
88

```

```

FIPS
USER MMSI
→GROUP MMSI
U. I. C.
DIRECTORY
AUTO. CH. SW
88

```

```

GROUP MMSI
→00000000
88

```

```

GROUP MMSI
500049638
88
→YES
NO

```

```

FIPS
USER MMSI
→GROUP MMSI
U. I. C.
DIRECTORY
AUTO. CH. SW
88

```

3-D. U.I.C

The **POLARIS** can transmit and receive, **USA**, **International**, and **Canada** frequencies. When you turn the **POLARIS** On, **USA** channel mode is set as the default.

1. Press and hold **H/L/MENU** for 2 seconds.



2. Press the **PUSH – SELECT** knob at **SETUP**, the **SETUP** menu appears.

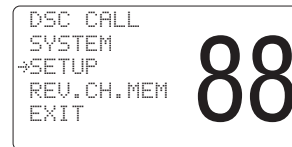

3. Rotate the **PUSH – SELECT** knob to select **U. I. C.**

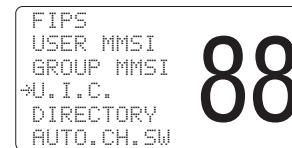

4. Press the **PUSH – SELECT** knob and the following screen appears.



5. Rotate the **PUSH – SELECT** knob to make your selection.

6. Press the **PUSH – SELECT** knob and the **POLARIS** returns to the channel display screen.



Note: The **POLARIS** radio remembers the last channel selected in each mode. The first time you enter each mode, channel 16 will be the default selected channel.

3-E. DIRECTORY

This function will allow you to send an individual call, etc. The Directory function memorizes the name and number of 20 other vessels. The following screen will allow you to setup an alphanumeric identity as well as the corresponding MMSI number.

1. Press and hold **H/L/MENU** for 2 seconds.



2. Press the **PUSH – SELECT** knob at **SETUP**, the **SETUP** menu appears.

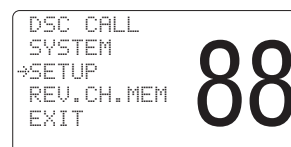

3. Press the **PUSH – SELECT** knob at **DIRECTORY**, the **DIRECTORY** menu appears.

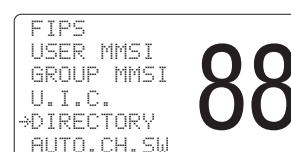

3-E-1. NEW

If you select NEW

1. Press and hold **H/L/MENU** for 2 seconds.

```

HI CAN
MEM
88
TELEPHONE
  
```

2. Press the **PUSH – SELECT** knob at **SETUP**, the **SETUP** menu appears.

```

DSC CALL
SYSTEM
->SETUP
REV. CH. MEM
EXIT
88
  
```

3. Press the **PUSH – SELECT** knob at **DIRECTORY**, the **DIRECTORY** menu appears.

```

FIPS
USER MMSI
GROUP MMSI
U. I. C.
->DIRECTORY
AUTO. CH. SW
88
  
```

4. Press the **PUSH – SELECT** at **NEW**, the following screen appears.

```

->NEW
KENT NEWMAN
PAUL HUBER
EXIT
88
  
```

5. You can now enter the person's name. Rotate the **PUSH – SELECT** knob, and press the **PUSH – SELECT** knob to choose the alphabet. The character will be entered when the **PUSH – SELECT** knob is pressed.

```

PERSONS NAME
<->
MMSI
00000000
88
  
```

6. After you enter the person's name, you can enter their MMSI number. Rotate the **PUSH – SELECT** knob clockwise to increase the number, counterclockwise to decrease. The number will be entered when the **PUSH – SELECT** knob is pressed, and the blinking digit moves to the right.

```
PERSONS NAME
COLLINS
MMSI
145678543< 88
```

7. After the directory data is entered, a confirmation screen appears.

```
PERSONS NAME
COLLINS
MMSI
145678543 88
→YES
NO
```

8. Press the **PUSH – SELECT** knob and the **POLARIS** returns to the following screen.

```
→NEW
KENT NEWMAN 88
PAUL HUBER
COLLINS
EXIT
```

3-E-2. EDIT

If you select EDIT

1. Press and hold **H/L/MENU** for 2 seconds.

```

HI CAN
MEM
88
TELEPHONE

```

2. Press the **PUSH – SELECT** knob at SETUP, the SETUP menu appears.

```

DSC CALL
SYSTEM
→SETUP
REV. CH. MEM
EXIT
88

```

3. Press the **PUSH – SELECT** knob at DIRECTORY, the DIRECTORY menu appears.

```

FIPS
USER MMSI
GROUP MMSI
U. I. C.
→DIRECTORY
AUTO. CH. SW
88

```

4. Press the **PUSH – SELECT** knob at the individual you want to edit.

```

NEW
→KENT NEWMAN
PAUL HUBER
EXIT
88

```

5. Press the **PUSH – SELECT** knob at EDIT.

```

→EDIT
DELETE
EXIT
88

```

6. You can now edit the person's name. Rotate the **PUSH – SELECT** knob, and press the **PUSH – SELECT** knob to choose the alphabet. The character will be entered when the **PUSH – SELECT** knob is pressed.

```
PERSONS NAME
->KENT NEWMAN
MMSI
123456734 88
```

7. After you edit the person's name, you can edit the MMSI. Rotate the **PUSH – SELECT** knob clockwise to increase the number, counterclockwise to decrease. The number will be entered when the **PUSH – SELECT** knob is pressed, and the blinking digit moves to the right.

```
PERSONS NAME
COLLINS
MMSI
145678543< 88
```

8. After the directory data is edited, a confirmation screen appears.

```
PERSONS NAME
COLLINS
MMSI
145678543
->YES
NO 88
```

9. Press the **PUSH – SELECT** knob and the **POLARIS** returns to the following screen.

```
NEW
->COLLINS
PAUL HUBER
EXIT 88
```

3-E-3. DELETE

If you select DELETE

1. Press and hold **H/L/MENU** for 2 seconds.
2. Press the **PUSH – SELECT** knob at SETUP, the SETUP menu appears.
3. Press the **PUSH – SELECT** knob at DIRECTORY, the DIRECTORY menu appears.
4. Press the **PUSH – SELECT** knob at the individual you want to delete.
5. Press the **PUSH – SELECT** knob at DELETE the following screen appears.
6. Press the **PUSH – SELECT** knob.
7. The **POLARIS** returns to the following screen.

```

HI CAN
MEM
88
TELEPHONE

```

```

DSC CALL
SYSTEM
→SETUP
REV. CH. MEM
EXIT
88

```

```

FIPS
USER MMSI
GROUP MMSI
U. I. C.
→DIRECTORY
AUTO. CH. SW
88

```

```

NEW
→KENT NEWMAN
PAUL HUBER
EXIT
88

```

```

EDIT
→DELETE
EXIT
88

```

```

DELETE
KENT NEWMAN
123456734
88
→YES
NO

```

```

NEW
→PAUL HUBER
EXIT
88

```

3-F. AUTO CHANNEL SWITCH

This feature is to allow you to disable the automatic channel change that happens when receiving a DSC call. This feature is useful when engaged in bridge – to – bridge or other safety related calls. When you have completed these calls, all of the incoming DSC calls received are available in the call log.

1. Press and hold **H/L/MENU** for 2 seconds.



2. Press the **PUSH – SELECT** knob at **SETUP**, the **SETUP** menu appears.

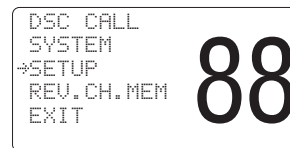

3. Rotate the **PUSH – SELECT** knob to select **AUTO. CH. SW.**

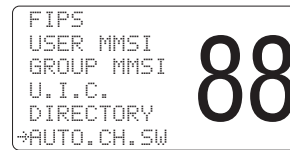

4. Press the **PUSH – SELECT** knob, and the following screen appears.



5. If you want to change this mode to **OFF**, you can change it by rotating the **PUSH – SELECT** knob. (Default is set as **ON**.)



6. Press the **PUSH – SELECT** knob and the **POLARIS** returns to the channel display screen.



3-G. POSITION REPLY

When the calling radio has requested the position information of the **POLARIS** radio, you can decide to transmit an acknowledgment automatically or on a call by call basis.

1. Press and hold **H/L/MENU** for 2 seconds.



2. Press the **PUSH – SELECT** knob at **SETUP**, the **SETUP** menu appears.

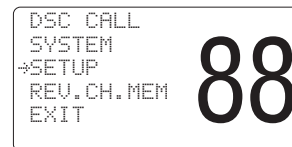

3. Rotate the **PUSH – SELECT** knob to select **POS. REPLY**.

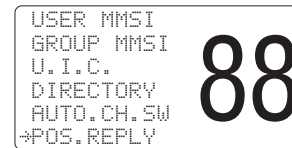

4. Press the **PUSH – SELECT** knob, and the following screen appears.



5. Rotate the **PUSH – SELECT** knob to make your selection.

Example: AUTO

When the **POLARIS** receives a position request, the following screen appears.

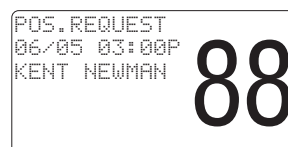
**Example: MANUAL**

When the **POLARIS** receives a position request, the following screen appears. Rotate the **PUSH – SELECT** knob to make your selection.

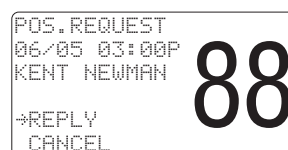

6. Press the **PUSH – SELECT** knob and the **POLARIS** returns to the following screen.



Note: If the **POLARIS** is set to **MANUAL**, you can select either **REPLY** or **CANCEL**.

3-H. CH TAG

This feature allows you to name each marine channel.

1. Press and hold **H/L/MENU** for 2 seconds.



2. Press the **PUSH – SELECT** knob at **SETUP**, the **SETUP** menu appears.



3. Rotate the **PUSH – SELECT** knob to select **CH TAG**.



4. Press the **PUSH – SELECT** knob, the following screen appears.



5. Press the **PUSH – SELECT** knob at the channel that you would like to **EDIT** or **DELETE**.

3-H-1. EDIT

If you select **EDIT**

1. Press and hold **H/L/MENU** for 2 seconds.



2. Press the **PUSH – SELECT** knob at **SETUP**, the **SETUP** menu appears.



3. Rotate the **PUSH – SELECT** knob to select CH TAG.

```
GROUP MMSI
U. I. C.
DIRECTORY
AUTO. CH. SW
POS. REPLY
→CH TAG
```

88

4. Press the **PUSH – SELECT** knob, the following screen appears. Press the **PUSH – SELECT** knob at the individual you want to edit.

```
→CH01 TELEPH
CH02 TELEPH
CH03 TELEPH
CH04 INTL
CH05 VTS
CH06 SAFETY
```

88

5. Press the **PUSH – SELECT** at EDIT, the following screen appears.

```
→EDIT
DELETE
EXIT
```

88

6. You can edit the name. Rotate the **PUSH – SELECT** knob clockwise or counterclockwise to select the alphabet, numeric, or symbols. The character will be entered when the **PUSH – SELECT** knob is pressed, and the blinking digit moves to the right.

```
CH01 TAG
→TELEPHONE
```

88

7. Press the **PUSH – SELECT** knob.

```
CH01 TAG
KENT
→YES
NO
```

88

8. The **POLARIS** returns to the following screen.

```
→CH01 KENT
CH02 TELEPH
CH03 TELEPH
CH04 INTL
CH05 VTS
CH06 SAFETY
```

88

3-H-2. DELETE

If you select DELETE

1. Press and hold **H/L/MENU** for 2 seconds.
2. Press the **PUSH – SELECT** knob at **SETUP**, the SETUP menu appears.
3. Rotate the **PUSH – SELECT** knob to select **CH TAG**.
4. Press the **PUSH – SELECT** knob, the following screen appears.
5. Press the **PUSH – SELECT** knob at the channel you want to delete.
6. Press the **PUSH – SELECT** knob at **DELETE**.
7. Press the **PUSH – SELECT** knob.

```

HI CAN
MEM
88
TELEPHONE
  
```

```

DSC CALL
SYSTEM
→SETUP
REV. CH. MEM
EXIT
88
  
```

```

GROUP MMSI
U. I. C.
DIRECTORY
AUTO. CH. SW
POS. REPLY
→CH TAG
88
  
```

```

→CH01 KENT
CH02 TELEPH
CH03 TELEPH
CH04 INTL
CH05 UTS
CH06 SAFETY
88
  
```

```

→CH01 KENT
CH02 TELEPH
CH03 TELEPH
CH04 INTL
CH05 UTS
CH06 SAFETY
88
  
```

```

EDIT
→DELETE
EXIT
88
  
```

```

DELETE
CH01
KENT
→YES
NO
88
  
```

8. The **POLARIS** returns to the following screen.

```

→CH01
CH02 TELEPH
CH03 TELEPH
CH04 INTL
CH05 VTS
CH06 SAFETY
88

```

3-I. WHAM

This feature, from the setup menu, will allow you to connect the **WHAM**.

Note: When you use the **WHAM** in addition to the **POLARIS** wired mic, please set the **BASE ID** for the **WHAM** the same as the **POLARIS**. (Please refer to the Owners Manual for the **WHAM**).

1. Press and hold **H/L/MENU** for 2 seconds.

```

HI CAN
MEM
88
TELEPHONE

```

2. Press the **PUSH – SELECT** knob at **SETUP**, the **SETUP** menu appears.

```

DSC CALL
SYSTEM
→SETUP
REV. CH. MEM
EXIT
88

```

3. Press the **PUSH – SELECT** knob at **WHAM**, the **WHAM** menu appears.

```

U. I. C.
DIRECTORY
AUTO. CH. SW
POS. REPLY
CH TAG
→WHAM
88

```

4. Press the **PUSH – SELECT** knob, and the following screen appears.

```

→BASE ID
LINK CH
EXIT
88

```

3-I-1. BASE ID

This number consist of 4 digits that you decide yourself. This feature allows you to set the Base ID. To use the **WHAM**, you must set the same Base ID for the **POLARIS** and **WHAM**, which enables the **POLARIS** and **WHAM** to communicate with one another.

1. Press and hold **H/L/MENU** for 2 seconds.

```

HI CAN
MEM
88
TELEPHONE
  
```

2. Press the **PUSH – SELECT** knob at **SETUP**, the **SETUP** menu appears.

```

DSC CALL
SYSTEM
→SETUP
REV. CH. MEM
EXIT
88
  
```

3. Press the **PUSH – SELECT** knob at **WHAM**, the **WHAM** menu appears.

```

U. I. C.
DIRECTORY
AUTO. CH. SW
POS. REPLY
CH TAG
→WHAM
88
  
```

4. Press the **PUSH – SELECT** knob at **BASE ID**, the following screen appears.

```

→BASE ID
LINK CH
EXIT
88
  
```

5. Rotate the **PUSH – SELECT** knob clockwise to increase the number, counterclockwise to decrease. The number will be entered when the **PUSH – SELECT** knob is pressed, and the blinking digit moves to the right. (You can select the number 0000 to 9999.)

```

BASE ID
0000
88
  
```

```

BASE ID
0001
88
  
```

6. After the **BASE ID** is entered, a confirmation screen appears. Rotate the **PUSH – SELECT** knob, and then press **PUSH – SELECT**.

```

→BASE ID
LINK CH
EXIT
88
  
```

3-I-2. LINK CH

This feature allows you to change the channel between the **POLARIS** and the **WHAM** if you encounter interference.

1. Press and hold **H/L/MENU** for 2 seconds.



2. Press the **PUSH – SELECT** knob at **SETUP**, the **SETUP** menu appears.

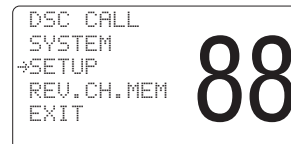

3. Press the **PUSH – SELECT** knob at **WHAM**, the **WHAM** menu appears.

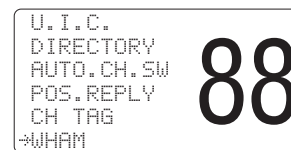

4. Press the **PUSH – SELECT** knob at **LINK CH**, the following screen appears.



5. Rotate the **PUSH – SELECT** knob clockwise to increase the number, counterclockwise to decrease. The number will be entered when the **PUSH – SELECT** knob is pressed.

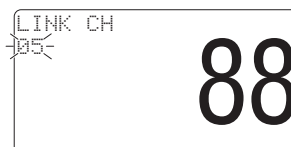

6. After the **LINK CH** is entered, a confirmation screen appears. Rotate the **PUSH – SELECT** knob, and then press **PUSH – SELECT**.



Note: You can select the channel 01-20.

3-J. ALARM CLOCK

This feature is only available when the GPS is connected to the NMEA0183 jack. If it is connected to the GPS, the alarms are set based on the satellite. You need to set the time previously to setting the alarm.

3-J-1. ALARM SET

This feature allows you to set the alarm.

1. Press and hold **H/L/MENU** for 2 seconds.
2. Press the **PUSH – SELECT** knob at **SETUP**, the **SETUP** menu appears.
3. Rotate and press the **PUSH – SELECT** knob to select **ALARM CLOCK**.
4. Press the **PUSH – SELECT** knob, the following screen appears.
5. Press the **PUSH – SELECT** knob at **ALARM SET**.
6. You can set the hour, minutes, am or pm by rotating the **PUSH – SELECT** knob. It will be entered when the **PUSH – SELECT** knob is pressed, and blinking digit moves to the right.
7. Press the **PUSH – SELECT** knob after you have selected am or pm. A confirmation screen appears. Press the **PUSH – SELECT** knob and the **POLARIS** returns to the **ALARM CLOCK** menu.

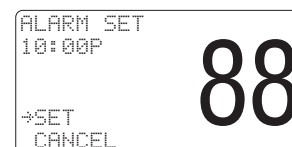
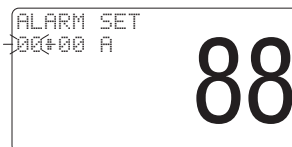
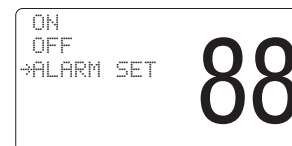
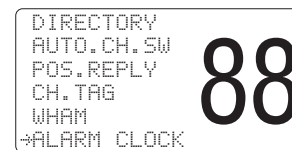
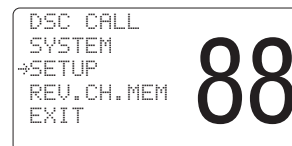

3-J-2. ALARM ON

This feature allows you to turn the alarm ON.

1. Press and hold **H/L/MENU** for 2 seconds.



2. Press the **PUSH – SELECT** knob at SETUP, the SETUP menu appears.

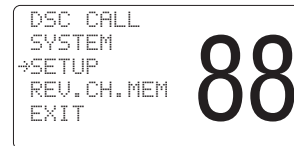

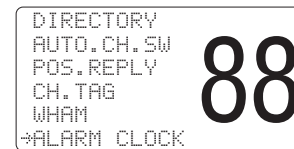

3. Rotate and press the **PUSH – SELECT** knob to select ALARM CLOCK.

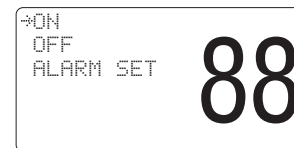

4. Press the **PUSH – SELECT** knob, the following screen appears.



5. Press the **PUSH – SELECT** knob at ON. The **POLARIS** returns to the channel display screen and the  icon appears.

6. When the **POLARIS** reaches the set time the alarm sounds and the  icon blinks.

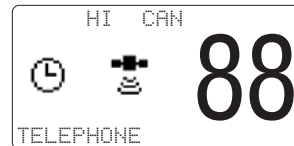

Note: The alarm sounds when the set time is reached, you can turn the alarm Off by pressing any key. Alarm mode will turn Off automatically once the alarm sounds.

3-J-3. ALARM OFF

This feature allows you to turn the alarm OFF.

1. Press and hold **H/L/MENU** for 2 seconds.



2. Press the **PUSH – SELECT** knob at **SETUP**, the **SETUP** menu appears.

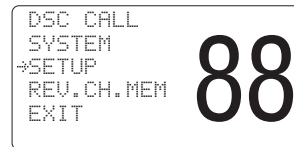

3. Rotate the **PUSH – SELECT** knob to select **ALARM CLOCK**.

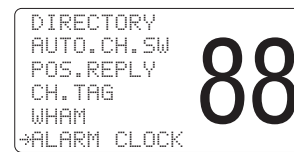

4. Press the **PUSH – SELECT** knob, the following screen appears.

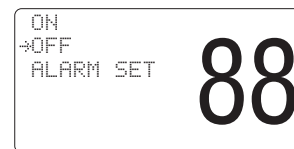

5. Press the **PUSH – SELECT** knob at **OFF**. The **POLARIS** returns to the channel display screen and the ☎ icon disappears.



3-K. TIME OFFSET

This feature allows you to set the time difference between local time and UTC (GMT) Time. This feature is only available when the GPS is connected to the NMEA0183 jack.

3-K-1. STANDARD

This feature allows you to set up the time difference manually.

1. Press and hold **H/L/MENU** for 2 seconds.
2. Press the **PUSH – SELECT** knob at **SETUP**, the **SETUP** menu appears.
3. Rotate the **PUSH – SELECT** knob to select **TIME OFFSET**.
4. Press the **PUSH – SELECT** knob at **STANDARD**, the following screen appears.
5. Rotate the **PUSH – SELECT** knob to select the appropriate time offset from GMT (UTC).
6. Press the **PUSH – SELECT** knob and the **POLARIS** returns to the channel display screen.

```
06/15 11:00P
054° 30.0KT
  70.00.000 N
 100.00.000 W
```

```
DSC CALL
SYSTEM
→SETUP
REV.CH.MEM
EXIT
```

```
AUTO.CH.SW
POS.REPLY
CH TAG
WHAM
ALARM CLOCK
→TIME OFFSET
```

```
→STANDARD
DAYLITE SAV
EXIT
```

```
-2
-1
→ 0 GMT
+1
+2
+3
```

```
06/15 11:00P
054° 30.0KT
  70.00.000 N
 100.00.000 W
```

Note: The time offset table is pre-programmed to include the standard North American time zones. (EST, CST, MST, and PST.)

3-K-2. DAYLITE SAV

This feature allows you to setup the time difference automatically by using the GPS module.

1. Press and hold **H/L/MENU** for 2 seconds.

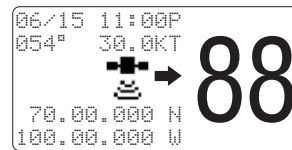

2. Press the **PUSH – SELECT** knob at SETUP, the SETUP menu appears.

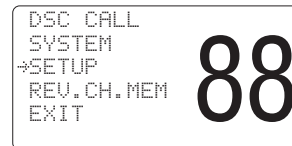

3. Rotate the **PUSH – SELECT** knob to select TIME OFFSET.

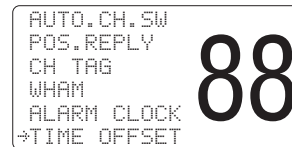

4. Press the **PUSH – SELECT** knob at DAYLITE SAV.

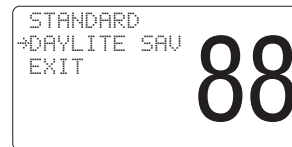

5. The **POLARIS** returns to the channel display screen.

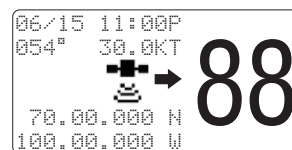

Note:  This icon will not appear if the **POLARIS** doesn't connect with the **GPS**.

4. REVIEW CHANNEL MEMORY

This feature allows you to review all of the channels that have been programmed into the memory.

1. Press and hold **H/L/MENU** for 2 seconds.



2. Press the **PUSH – SELECT** knob at REV. CH. MEM, the MEMORY menu appears.

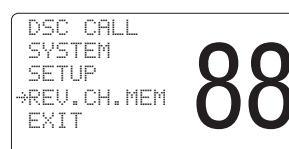

3. Rotate the **PUSH – SELECT** knob to highlight the registered channel.

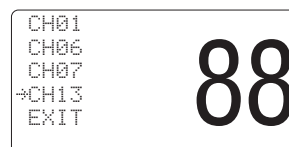

4. Press the **PUSH – SELECT** knob, the selected channel appears.



Note: When there are no channels registered in memory, an error tone sounds.

NMEA Technical Setup

POLARIS NMEA0183 GPS Input Connection Specification

This section is useful when attaching an external GPS to the **POLARIS** radio. Many GPS units have a setup menu to be able to configure the NMEA0183 serial data output. This output can be used to supply information to other devices on the vessel, such as the **POLARIS** DSC VHF radio, auto pilots, chart plotters, etc.

To setup the GPS to be used with the **POLARIS** radio, the following items need to be considered for proper operation:

1. Baud Rate – Set the Baud rate to 4800.
2. Data Bits – Set the Data Bits to 8.
3. Parity – Set the Parity to None.
4. Stop Bits – Set the Stop Bits to 1.
5. GPRMC Command – This command is used by the **POLARIS** and includes the UTC Time, Latitude, Longitude, Speed, Direction, and Date information.

The data amplitude : Over 3.0V

Drive capability : Over 10mA

Optional Accessories

- Flush mounting bracket for “in dash” installation.

Contact your Uniden Dealer for information.

VHF FM Marine Radio Telephone Channel and Functions (USA Channels)

CHANNEL DESIG	FREQUENCY (MHz)		TYPE OF TRAFFIC	SHIP TO SHIP	SHIP TO SHORE	CH TAG
	TRANSMIT	RECEIVE				
WX0	—	163.275	NOAA Weather	RX Only	RX Only	
WX1	—	162.550	NOAA Weather	RX Only	RX Only	
WX2	—	162.400	NOAA Weather	RX Only	RX Only	
WX3	—	162.475	NOAA Weather	RX Only	RX Only	
WX4	—	162.425	NOAA Weather	RX Only	RX Only	
WX5	—	162.450	NOAA Weather	RX Only	RX Only	
WX6	—	162.500	NOAA Weather	RX Only	RX Only	
WX7	—	162.525	NOAA Weather	RX Only	RX Only	
WX8	—	161.650	Can. Weather	RX Only	RX Only	
WX9	—	161.775	Can. Weather	RX Only	RX Only	
01	156.050	156.050	VTS	Yes	Yes	VTS
02						
03	156.150	156.150	Port Ops	Yes	Yes	
04						
05	156.250	156.250	VTS	Yes	Yes	VTS
06	156.300	156.300	Safety	Yes	No	SAFETY
07	156.350	156.350	Com'l	Yes	Yes	COMMERCIAL
08	156.400	156.400	Com'l	Yes	No	COMMERCIAL
09	156.450	156.450	Com'l & Non Com'l	Yes	Yes	CALLING
10	156.500	156.500	Com'l	Yes	Yes	COMMERCIAL
11	156.550	156.550	Com'l	Yes	Yes	VTS
12	156.600	156.600	Port Ops	Yes	Yes	VTS
13	156.650	156.650	Navigational, TX 1W only	Yes	Yes	BRG/BRG
14	156.700	156.700	Port Ops	Yes	Yes	VTS
15	—	156.750	Environmental	RX Only	RX Only	COMMERCIAL
16	156.800	156.800	Safety Calling	Yes	Yes	DISTRESS
17	156.850	156.850	State Control	Yes	Yes	SAR
18	156.900	156.900	Com'l	Yes	Yes	COMMERCIAL
19	156.950	156.950	Com'l	Yes	Yes	COMMERCIAL
20	157.000	157.000	Port Ops, RX Duplex	Yes	Yes	PORT OPR
21	157.050	157.050	Coast Guard	Yes	Yes	CCG
22	157.100	157.100	Coast Guard	Yes	Yes	USCG
23	157.150	157.150	Coast Guard	Yes	Yes	USCG
24	157.200	161.800	Public Corresp,Duplex	No	Yes	TELEPHONE
25	157.250	161.850	Public Corresp,Duplex	No	Yes	TELEPHONE
26	157.300	161.900	Public Corresp,Duplex	No	Yes	TELEPHONE
27	157.350	161.950	Public Corresp,Duplex	No	Yes	TELEPHONE
28	157.400	162.000	Public Corresp,Duplex	No	Yes	TELEPHONE
60						
61	156.075	156.075				CCG
62						
63	156.175	156.175				VTS
64	156.225	156.225				COMMERCIAL
65	156.275	156.275	Port Ops	Yes	Yes	PORT OPR
66	156.325	156.325	Port Ops	Yes	Yes	PORT OPR
67	156.375	156.375	Com'l, TX 1W only	Yes	No	BRG/BRG
68	156.425	156.425	Non Com'l	Yes	Yes	SHIP-SHIP
69	156.475	156.475	Non Com'l	Yes	Yes	PLEASURE
70	156.525	156.525				DSC
71	156.575	156.575	Non Com'l	Yes	Yes	PLEASURE
72	156.625	156.625	Non Com'l	Yes	No	SHIP-SHIP
73	156.675	156.675	Port Ops	Yes	Yes	PORT OPR
74	156.725	156.725	Port Ops	Yes	Yes	PORT OPR
77	156.875	156.875	Port Ops	Yes	No	PORT OPR
78	156.925	156.925	Non Com'l	Yes	Yes	SHIP-SHIP
79	156.975	156.975	Com'l	Yes	Yes	SHIP-SHIP
80	157.025	157.025	Com'l	Yes	Yes	SHIP-SHIP
81	157.075	157.075	Coast Guard	Yes	Yes	CCG
82	157.125	157.125	US Govt Only	Yes	Yes	CCG
83	157.175	157.175	Coast Guard	Yes	Yes	USCG
84	157.225	161.825	Public Corresp,Duplex	No	Yes	TELEPHONE
85	157.275	161.875	Public Corresp,Duplex	No	Yes	TELEPHONE
86	157.325	161.925	Public Corresp,Duplex	No	Yes	TELEPHONE
87	157.375	161.975	Public Corresp,Duplex	No	Yes	TELEPHONE
88	157.425	157.425	Com'l	Yes	No	COMMERCIAL

VHF FM Marine Radio Telephone Channel and Functions (International Channels)

CHANNEL DESIG	FREQUENCY (MHz)		TYPE OF TRAFFIC	SHIP TO SHIP	SHIP TO SHORE	CH TAG
	TRANSMIT	RECEIVE				
WX0	—	163.275	NOAA Weather	RX Only	RX Only	
WX1	—	162.550	NOAA Weather	RX Only	RX Only	
WX2	—	162.400	NOAA Weather	RX Only	RX Only	
WX3	—	162.475	NOAA Weather	RX Only	RX Only	
WX4	—	162.425	NOAA Weather	RX Only	RX Only	
WX5	—	162.450	NOAA Weather	RX Only	RX Only	
WX6	—	162.500	NOAA Weather	RX Only	RX Only	
WX7	—	162.525	NOAA Weather	RX Only	RX Only	
WX8	—	161.650	Can. Weather	RX Only	RX Only	
WX9	—	161.775	Can. Weather	RX Only	RX Only	
01	156.050	160.650	VTS,Duplex	Yes	Yes	TELEPHONE
02	156.100	160.700	Port Ops,Duplex	Yes	Yes	TELEPHONE
03	156.150	160.750	Port Ops,Duplex	Yes	Yes	TELEPHONE
04	156.200	160.800	Port Ops,Duplex	Yes	Yes	INTL
05	156.250	160.850	VTS,Duplex	Yes	Yes	INTL
06	156.300	156.300	Safety	Yes	No	SAFETY
07	156.350	160.950	Com',Duplex	Yes	Yes	INTL
08	156.400	156.400	Com'l	Yes	No	COMMERCIAL
09	156.450	156.450	Com'l & Non Com'l	Yes	Yes	CALLING
10	156.500	156.500	Com'l	Yes	Yes	COMMERCIAL
11	156.550	156.550	Com'l	Yes	Yes	VTS
12	156.600	156.600	Port Ops	Yes	Yes	VTS
13	156.650	156.650	Navigational	Yes	Yes	BRG/BRG
14	156.700	156.700	Port Ops	Yes	Yes	VTS
15	156.750	156.750	Environmental	Yes	Yes	COMMERCIAL
16	156.800	156.800	Safety Calling	Yes	Yes	DISTRESS
17	156.850	156.850	State Control	Yes	Yes	SAR
18	156.900	161.500	Com'l,Duplex	Yes	Yes	INTL
19	156.950	161.550	Com'l,Duplex	Yes	Yes	INTL
20	157.000	161.600	Port Ops,Duplex	Yes	Yes	PORT OPR
21	157.050	161.650	Coast Guard,Duplex	Yes	Yes	INTL
22	157.100	161.700	Coast Guard,Duplex	Yes	Yes	INTL
23	157.150	161.750	Coast Guard,Duplex	Yes	Yes	INTL
24	157.200	161.800	Public Corresp,Duplex	No	Yes	TELEPHONE
25	157.250	161.850	Public Corresp,Duplex	No	Yes	TELEPHONE
26	157.300	161.900	Public Corresp,Duplex	No	Yes	TELEPHONE
27	157.350	161.950	Public Corresp,Duplex	No	Yes	TELEPHONE
28	157.400	162.000	Public Corresp,Duplex	No	Yes	TELEPHONE
60	156.025	160.625	Duplex			TELEPHONE
61	156.075	160.675	Duplex			INTL
62	156.125	160.725	Duplex			INTL
63	156.175	160.775	Duplex			INTL
64	156.225	160.825	Duplex			TELEPHONE
65	156.275	160.875	Port Ops,Duplex	Yes		INTL
66	156.325	160.925	Port Ops,Duplex	Yes	Yes	INTL
67	156.375	156.375	Com'l	Yes	No	BRG/BRG
68	156.425	156.425	Non Com'l	Yes	Yes	SHIP-SHIP
69	156.475	156.475	Non Com'l	Yes	Yes	PLEASURE
70	156.525	156.525				DSC
71	156.575	156.575	Non Com'l	Yes	Yes	PLEASURE
72	156.625	156.625	Non Com'l	Yes	No	SHIP-SHIP
73	156.675	156.675	Port Ops	Yes	Yes	PORT OPR
74	156.725	156.725	Port Ops	Yes	Yes	PORT OPR
77	156.875	156.875	Port Ops	Yes	No	PORT OPR
78	156.925	161.525	Non Com'l,Duplex	Yes	Yes	INTL
79	156.975	161.575	Com'l,Duplex	Yes	Yes	INTL
80	157.025	161.625	Com'l,Duplex	Yes	Yes	INTL
81	157.075	161.675	Coast Guard,Duplex	Yes	Yes	INTL
82	157.125	161.725	US Govt Only,Duplex	Yes	Yes	INTL
83	157.175	161.775	Coast Guard,Duplex	Yes	Yes	INTL
84	157.225	161.825	Public Corresp,Duplex	No	Yes	TELEPHONE
85	157.275	161.875	Public Corresp,Duplex	No	Yes	TELEPHONE
86	157.325	161.925	Public Corresp,Duplex	No	Yes	TELEPHONE
87	157.375	161.975	Public Corresp,Duplex	No	Yes	TELEPHONE
88	157.425	162.025	Com'l,Duplex	Yes	No	TELEPHONE

VHF FM Marine Radio Telephone Channel and Functions (Canadian Channels)

CHANNEL DESIG	FREQUENCY (MHz)		TYPE OF TRAFFIC	SHIP TO SHIP	SHIP TO SHORE	CH TAG
	TRANSMIT	RECEIVE				
WX0	—	163.275	NOAA Weather	RX Only	RX Only	
WX1	—	162.550	NOAA Weather	RX Only	RX Only	
WX2	—	162.400	NOAA Weather	RX Only	RX Only	
WX3	—	162.475	NOAA Weather	RX Only	RX Only	
WX4	—	162.425	NOAA Weather	RX Only	RX Only	
WX5	—	162.450	NOAA Weather	RX Only	RX Only	
WX6	—	162.500	NOAA Weather	RX Only	RX Only	
WX7	—	162.525	NOAA Weather	RX Only	RX Only	
WX8	—	161.650	Can. Weather	RX Only	RX Only	
WX9	—	161.775	Can. Weather	RX Only	RX Only	
01	156.050	160.650	Duplex	Yes	Yes	TELEPHONE
02	156.100	160.700	Duplex	Yes	Yes	TELEPHONE
03	156.150	160.750	Duplex	Yes	Yes	TELEPHONE
04	156.200	156.200		Yes	Yes	INTL
05	156.250	156.250		Yes	Yes	VTS
06	156.300	156.300		Yes	No	SAFETY
07	156.350	156.350		Yes	Yes	COMMERCIAL
08	156.400	156.400		Yes	No	COMMERCIAL
09	156.450	156.450		Yes	Yes	CALLING
10	156.500	156.500		Yes	Yes	COMMERCIAL
11	156.550	156.550		Yes	Yes	VTS
12	156.600	156.600		Yes	Yes	VTS
13	156.650	156.650	1W	Yes	Yes	BRG/BRG
14	156.700	156.700		Yes	Yes	VTS
15	156.750	156.750	1W	Yes	Yes	COMMERCIAL
16	156.800	156.800		Yes	Yes	DISTRESS
17	156.850	156.850	1W	Yes	Yes	SAR
18	156.900	156.900		Yes	Yes	COMMERCIAL
19	156.950	156.950		Yes	Yes	COMMERCIAL
20	157.000	161.600	Duplex, 1W	Yes	Yes	PORT OPR
21	157.050	157.050		Yes	Yes	CCG
22	157.100	157.100		Yes	Yes	USCG
23	157.150	161.750	Duplex	Yes	Yes	INTL
24	157.200	161.800	Duplex	No	Yes	TELEPHONE
25	157.250	161.850	Duplex	No	Yes	TELEPHONE
26	157.300	161.900	Duplex	No	Yes	TELEPHONE
27	157.350	161.950	Duplex	No	Yes	TELEPHONE
28	157.400	162.000	Duplex	No	Yes	TELEPHONE
60	156.025	160.625	Duplex			TELEPHONE
61	156.075	156.075				CCG
62	156.125	156.125				INTL
63	—	—				
64	156.225	156.225	Simplex			COMMERCIAL
65	156.275	156.275		Yes	Yes	PORT OPR
66	156.325	156.325		Yes	Yes	PORT OPR
67	156.375	156.375		Yes	No	BRG/BRG
68	156.425	156.425		Yes	Yes	SHIP-SHIP
69	156.475	156.475		Yes	Yes	PLEASURE
70	156.525	156.525				DSC
71	156.575	156.575		Yes	Yes	PLEASURE
72	156.625	156.625		Yes	No	SHIP-SHIP
73	156.675	156.675		Yes	Ye	PORT OPR
74	156.725	156.725		Yes	Ye	PORT OPR
77	156.875	156.875		Yes	No	PORT OPR
78	156.925	156.925		Yes	Yes	SHIP-SHIP
79	156.975	156.975		Yes	Yes	SHIP-SHIP
80	157.025	157.025		Yes	Yes	SHIP-SHIP
81	157.075	157.075		Yes	Yes	CCG
82	157.125	157.125		Yes	Yes	CCG
83	157.175	157.175		Yes	Yes	USCG
84	157.225	161.825	Duplex	No	Yes	TELEPHONE
85	157.275	161.875	Duplex	No	Yes	TELEPHONE
86	157.325	161.925	Duplex	No	Yes	TELEPHONE
87	157.375	161.975	Duplex	No	Yes	TELEPHONE
88	157.425	162.025	Duplex	Yes	No	TELEPHONE

NWR-SAME EVENT CODE

Event Code	Standard	EVENT LEVEL (Siren Type)				LCD Display
		Warning	Watch	Statement	Test	
Emergency Action Notification	EAN	0				EMG NOTIFY
Emergency Action Termination	EAT	0				EMG END
National Information Center	NIC	0				NATION INFO
Tornado Warning #	TOW (or TOR)	0				TORNADO
Severe Thunderstorm Warning #	SVW (or SVR)	0				THUNDERSTORM
Flash Flood Warning	FFW	0				FLASH FLOOD
Flood Warning	FLW	0				FLOOD
Winter Storm Warning	WSW	0				WINTER STORM
Blizzard Warning	BZW	0				BLIZZARD
High Wind/Dust Storm Warning	HWW	0				HIGH WIND
Radiological Hazard Warning	RHW	0				RADIOLOGICAL
Civil Danger Warning	CDW	0				CIVILDANGER
Local Area Emergency	LAE	0				LOCAL EMG
Hazardous Material Warning	HMW	0				HAZARDOUS
Civil Emergency Message	CEM	0				CIVIL EMG
Immediate Evacuation Warning	IEW	0				EVACUATION
Immediate Evacuation Notice	EVI	0				EVACUATENOTE
Law Enforcement Warning	LEW	0				LAW ENFORCE
Fire Warning	FRW	0				FIRE
Hurricane/Tropical Storm Warning	HUW	0				HURRICANE
Tsunami Warning	TSW	0				TSUNAMI
Coastal Flood Warning	CFW	0				COAST FLOOD
Special Marine Warning	SMW	0				SPECIAL MRN
Avalanche Warning	AVW	0				AVALANCHE
Volcano Warning	VOW	0				VOLCANO
Shelter In Place Warning	SPW	0				SHELTER
Civil Danger Watch	CDA		0			CIVIL DANGER
Radiological Hazard Watch	RHA		0			RADIOLOGICAL
Hazardous Material Watch	HMA		0			HAZARDOUS
Winter Storm Watch	WSA		0			WINTER STORM
High Wind/Dust Storm Watch	HWA		0			HIGH WIND
Tornado Watch	TOA		0			TORNADO
Severe Thunderstorm Watch	SVA		0			THUNDERSTORM
Flash Flood Watch	FFA		0			FLASH FLOOD
Flood Watch	FLA		0			FLOOD
Hurricane/Tropical Storm Watch	HUA		0			HURRICANE
Tsunami Watch	TSA		0			TSUNAMI
Coastal Flood Watch	CFA		0			COAST FLOOD
Avalanche Watch	AVA		0			AVALANCHE
Volcano Watch	VOA		0			VOLCANO
Severe Weather Statement	SVS			0		SEVERE WX
Special Weather Statement	SPS			0		SPECIAL WX
Flash Flood Statement	FFS			0		FLASH FLOOD
Flood Statement	FLS			0		FLOOD
Hurricane Statement	HLS			0		HURRICANE
National Periodic Test	NPT				0	NATIONPERIOD
Required Monthly Test	RMT				0	MONTHLY
Required Weekly Test	RWT				0	WEEKLY
System Demonstration/Practice	DMO					SYSTEM DEMO
NATIONAL HAZARD WARNING	NHW	0				NATIONHAZARD
UNKNOWN EMERGENCY TUNE TV	**E	0				UNKNOWN TV
UNKNOWN WARNING TUNE TV	**W	0				UNKNOWN TV
UNKNOWN WATCH TUNE TV	**A		0			UNKNOWN TV
UNKNOWN STATEMENT TUNE TV	**S			0		UNKNOWN TV

Specification

General

Channels	: Transmit 55 Receive 80 Marine/10 Weather
Controls	: On-Off/Volume, Squelch
Status Indicators	: TX (Transmit), TRI (Triple Watch), HI (High), LO (Low), USA, CAN, INT, ALT, MEM, WX and Channel Display
Channel Display	: LCD (Full DotMatrix)
Selector Switch	: Channel Selector switch
Buttons	: WX, 16/9, SCAN, H/L, and DISTRESS
Connectors	: Antenna, Remote, ACC, and DC power
Size	: H78 mm x W184 mm x L168 mm (W/O Heat Sink) H3.07 inches x W7.24 inches x L6.61 inches
Weight	: 1.2 kg / 2.65 lbs / 42.3 oz
Supply Voltage	: 13.8V DC negative ground
Standard Accessories	: Mounting bracket and hardware, DC power cord, microphone hanger, spare fuse, ACC Cable
Antenna Impedance	: 50 Ω nominal
Microphone	: Rugged 2 k Ω condenser mic element with coiled cord
Speaker	: 1.82 inch, 8 Ω
Operating Temperature Range	: -20 $^{\circ}$ C to + 50 $^{\circ}$ C (-4 $^{\circ}$ F to +122 $^{\circ}$ F)
Shock and Vibration	: Meets or exceeds EIA standards, RS152B and RS204C
FCC Approvals	: Type accepted under part 80 of the Rules; meets Great Lakes Agreement and party boat requirements

Transmitter

Power Output	: 1 watt or 25 watt (switch selectable)
Power Requirement	: Not rated on LO, 25 watts output: 4.5A@13.8V DC
Modulation	: FM \pm 5 kHz deviation (FCC designator F3E)
Hum and Noise Signal-to-Noise	: 45 dB@1 kHz with 3 kHz deviation with 1000 Hz modulating frequency (nominal)
Audio Distortion	: Less than 8% with 3 kHz deviation with 1000 Hz modulating frequency
Spurious Suppression	: -25 dBm @ Hi, -25 dBm @ Lo
Output Power Stabilization	: Built-in automatic level control (ALC)
Frequency Range	: 156 to 158 MHz
Frequency Stability	: \pm 10 ppm @ -20 $^{\circ}$ C to + 50 $^{\circ}$ C

Receiver

Frequency Range	: 156 to 163 MHz
Sensitivity	: 0.25 μ V for 12 dB SINAD
Circuit	: Dual Conversion Super Heterodyne PLL
Squelch Sensitivity	: 0.6 μ V Threshold
Spurious Response	: 65 dB
Adjacent Channel Selectivity	: 65 dB @ \pm 25 kHz
Audio Output Power	: 3.0 watts (10% Distortion)
Power Requirement	: 400 mA @ 13.8V DC squelched, 0.7A @ 13.8V DC at maximum audio output
IF Frequencies	: 1st 21.4 MHz, 2nd -455 kHz

Troubleshooting

If the **POLARIS** does not perform to your expectations, try the suggestions listed below. If you cannot get satisfactory results, call the Uniden Technical Support at (800) 586-0409, 8:00 a.m. to 5:00 p.m., Central Standard Time, Monday through Friday.

SYMPTOM	CAUSE	REMEDY
Won't power On.	No or low voltage.	Check for proper voltage getting to the set.
When the PTT is pressed - Tx icon comes on and another radio can hear a "click" but no audio is heard.	Bad mic element.	Send in for repair.
While scanning, the radio stops on a particular channel all of the time.	A source of noise is nearby.	Eliminate the source of the noise or delete the channel from the scanner.
There is noise on the receiver that the squelch will not eliminate.	An external noise is being generated by some device.	Either turn off the offending device or contact that Mfg. Regarding FCC part 15 "unintentional radiator".

Care and Maintenance

Your **POLARIS** is a precision of electronic equipment and you should treat it accordingly. Due to the rugged design, very little maintenance is required. However, a few precautions should be observed:

- If the antenna has been damaged, you should not transmit except in the case of an emergency. A defective antenna may cause damage to your radio.
- You are responsible for continued FCC technical compliance of your radio.
- You are urged to arrange for periodic performance checks with your Uniden Marine dealer.

Three Year Limited Warranty

WARRANTOR: UNIDEN AMERICA CORPORATION ("Uniden")

ELEMENTS OF WARRANTY: Uniden warrants, for three years, to the original retail owner, this Uniden Product to be free from defects in materials and craftsmanship with only the limitations or exclusions set out below.

WARRANTY DURATION: This warranty to the original user shall terminate and be of no further effect 36 months after the date of original retail sale. The warranty is invalid if the Product is (A) damaged or not maintained as reasonable or necessary, (B) modified, altered, or used as part of any conversion kits, subassemblies, or any configurations not sold by Uniden, (C) improperly installed, (D) serviced or repaired by someone other than an authorized Uniden service center for a defect or malfunction covered by this warranty, (E) used in any conjunction with equipment or parts or as part of any system not manufactured by Uniden, or (F) installed or programmed by anyone other than as detailed by the Operating Guide for this product.

STATEMENT OF REMEDY: In the event that the product does not conform to this warranty at any time while this warranty is in effect, warrantor will repair the defect and return it to you without charge for parts, service, or any other cost (except shipping and handling) incurred by warrantor or its representatives in connection with the performance of this warranty. THE LIMITED WARRANTY SET FORTH ABOVE IS THE SOLE AND ENTIRE WARRANTY PERTAINING TO THE PRODUCT AND IS IN LIEU OF AND EXCLUDES ALL OTHER WARRANTIES OF ANY NATURE WHATSOEVER, WHETHER EXPRESS, IMPLIED OR ARISING BY OPERATION OF LAW, INCLUDING, BUT NOT LIMITED TO ANY IMPLIED WARRANTIES OF MERCHANTABILITY OR FITNESS FOR A PARTICULAR PURPOSE. THIS WARRANTY DOES NOT COVER OR PROVIDE FOR THE REIMBURSEMENT OR PAYMENT OF INCIDENTAL OR CONSEQUENTIAL DAMAGES. Some states do not allow this exclusion or limitation of incidental or consequential damages so the above limitation or exclusion may not apply to you.

LEGAL REMEDIES: This warranty gives you specific legal rights, and you may also have other rights which vary from state to state. This warranty is void outside the United States of America.

PROCEDURE FOR OBTAINING PERFORMANCE OF WARRANTY: If, after following the instructions in this Operating Guide you are certain that the Product is defective, pack the Product carefully (preferably in its original packaging). Include evidence of original purchase and a note describing the defect that has caused you to return it. The Product should be shipped freight prepaid, by traceable means, or delivered, to warrantor at:

**Uniden America Corporation
Parts and Service Division
4700 Amon Carter Blvd.
Ft. Worth, TX 76155
(800) 235-3874, 8 AM to 5 PM Central,
Monday through Friday**



Go wireless anywhere on your boat!

WHAM (Wireless Handheld Access Microphone)

WHAM is a portable mic that operates with the Polaris radio. It is compact and lightweight to fit easily in the palm of your hand. The Polaris radio works with up to two wireless mic accessories WHAM and WHAM2 (optional). These wireless handheld microphones will give you consistent, outstanding performance in virtually all marine conditions. With Uniden, when you're out, you're never out of touch.

A World Without Wires | **Uniden**[®]

Thank you for purchasing a Uniden Marine Radio.

© 2002 Uniden America Corporation, Fort Worth, TX
All rights reserved.
May contain foreign articles.

Custom manufactured in the Philippines.

Printed in the Philippines
UTZZ01888ZA

Free Manuals Download Website

<http://myh66.com>

<http://usermanuals.us>

<http://www.somanuals.com>

<http://www.4manuals.cc>

<http://www.manual-lib.com>

<http://www.404manual.com>

<http://www.luxmanual.com>

<http://aubethermostatmanual.com>

Golf course search by state

<http://golfingnear.com>

Email search by domain

<http://emailbydomain.com>

Auto manuals search

<http://auto.somanuals.com>

TV manuals search

<http://tv.somanuals.com>