

UH-048XR

Operating Guide



Uniden

WARNING!

- Do not operate the transmitter of any radio equipment unless all the Radio Frequency (RF) connectors are secured and any open connectors are properly terminated.
- Do not operate the transmitter of any radio equipment near electrical blasting caps or in an explosive atmosphere.
- Do not let children operate any transmitter-equipped radio equipment unless supervised.
- Have your radio equipment serviced by a qualified Uniden technician.
- Do not operate the transmitter of any radio equipment with the antenna touching or close to the eyes, face, or exposed body parts.



The exclamation point within an equilateral triangle is intended to alert the user to the presence of important operating and maintenance (servicing) instructions in the literature accompanying the appliance.

CONTENTS

Introduction

Features	1
Technical Support & Service	2
Included in your UH-048XR Package	3

Getting Started

Battery Installation	4
Low Battery Alert	5
Belt Clip	5
Wrist Strap	6

Operation

Power on/off	7
Volume	7
Selecting Channel	8
To Transmit and Receive	8
To Operate in Dual-Watch	9
Scanning	10
Continuous Tone Coded Squelch (CTCSS)	11
CTCSS Tone Display	12
Voice Activated (VOX)	13
VOX Recovery Time	13
Auto Keylock	14
Call Melody	15
Monitor	16
Battery Level Display	17
Battery Charge	18

UHF Channels and Frequencies	19
-------------------------------------	----

CTCSS Codes and Frequencies	20
------------------------------------	----

Optional Accessories	20
-----------------------------	----

Technical Specifications	21
---------------------------------	----

Warranty	23
-----------------	----

Controls & Indicators	25
----------------------------------	----

INTRODUCTION

The **UH-048XR** is a portable two-way UHF-CB radio. It is compact, rugged and fits easily in your hand. This hand held UHF radio will give you consistent, outstanding performance in virtually all conditions and situations. To ensure that you get the most from the **UH-048XR**'s features, please read this operating guide carefully before using the unit.

FEATURES

- 40 Channels
- 38 Built-in Continuous Tone Coded Squelch System (CTCSS)
- 500mW Output Power
- Up to 3 km range*
- LCD Display
- Scan
- Monitor
- LCD Back Light (Auto On for 5 Sec)
- Auto Power Save
- Battery Level Indicator
- Built in Keypad Lock
- Key Lock On/Off
- Key Touch Tone On/Off
- 7 Different Ring Tones
- Auto Squelch Control

** Range varies depending on the environment 3km range is noted in a flat open environment.*

TECHNICAL SUPPORT AND SERVICE

Should you find it desirable or necessary to service your **UH-048XR**, we suggest you contact the Uniden dealer where you purchased your radio. Your dealer will be able to assist you with the complete service information.

If you require service that is within the terms of your warranty, you should present a copy of your receipt to your dealer to authenticate your claim.

If you find it inconvenient to obtain service assistance from a dealer, please pack your radio in a suitable packaging that will provide adequate protection to your radio. Enclose a note describing the problem, a copy of your receipt, and send it prepaid to:

AUSTRALIA:

Uniden Australia Pty Ltd
Customer Service Division
345 Princes Highway
Rockdale NSW 2216
Ph. (02) 9599-3577
Fax. (02) 9599-3278
Toll Free 1300 366 895

NEW ZEALAND:

Uniden New Zealand Ltd
Customer Service Division
150 Harris Road
East Tamaki, Auckland
Ph. (9) 273 8383
Fax. (9) 274 4253
Toll Free 0800 4 UNIDEN
4 864336

Caution: *Changes or modifications to this product not expressly approved by Uniden; or operation of this product in any way other than as detailed by this Operating Guide, can void your warranty and authority to operate this product.*

INCLUDED IN YOUR UH-048XR PACKAGE



UH-048XR

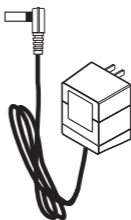

AC Adaptor



Wrist Strap



Belt Clip

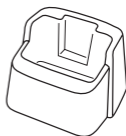

Desk Top
Charger



Operating Guide



Product Registration
Card & other printed
materials

Note: If any of these items are missing from the box, contact your Uniden Dealer.

GETTING STARTED

BATTERY INSTALLATION

Your UH048XR radio uses 4 AAA batteries (not supplied) for power.

Please refer to page 14 should you wish to use rechargeable batteries.



Do not mix old and new batteries for optimum performance.

To install the batteries:

1. Make sure your radio is off.

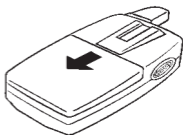

2. Press battery cover release. Slide cover off.

3. Insert 4 AAA batteries (not supplied) according to the polarity symbols inside the battery compartment.

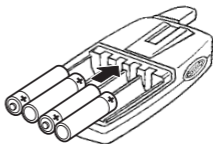

4. Slide the battery cover forward until it snaps into place.

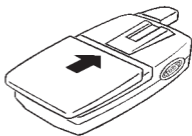

LOW BATTERY ALERT

The LCD on your radio shows a battery meter in the upper right corner.  icon

indicates a fully powered unit. As the batteries lose power,  will flash.



When the batteries in the unit are low replace the batteries immediately to continue using the radio.

BELT CLIP

Because you will probably use your radio when you are out and about, the unit comes equipped with a belt clip to securely fasten the unit to your belt, pocket or bag.

To attach the belt clip:

Slide the belt clip until it snaps into place.

To remove the belt clip:

To remove the belt clip. Press and hold belt clip locker, slide the belt clip at the same time until released.

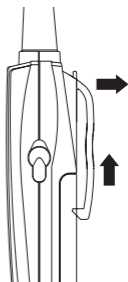
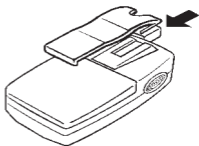

WRIST STRAP

1. Insert the short end of the strap through the belt clip hole in the top of the belt clip.
2. Slip the long end through the loop to enclose the clip in the strap and pull tight.

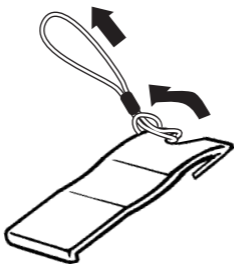
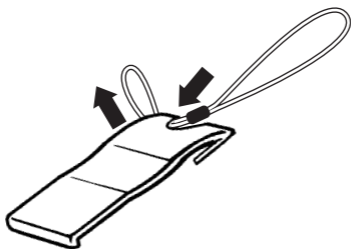

OPERATION

- When you press any key (except PTT), a short tone sounds.
- See the Controls and Indicators page at the back of this operating guide for button and key operations.

POWER ON/OFF

Press and hold **[Power/Enter]** button until a melody is heard. A channel number and battery level should appear on the display.

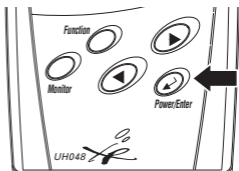

To turn the unit **OFF**, press and hold **[Power/Enter]** button until a melody is heard.

VOLUME

1. Press the **[Monitor]** button to hear background noise. The “monitor” icon  will appear on the display.

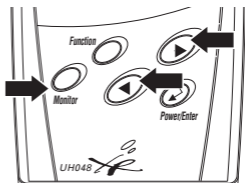

2. Press the **[▲]** or **[▼]** to set the volume level. There are 8 level volume settings.



SELECTING CHANNEL

1. Press [**Function**] until “**CH**” appears in the large display. The current channel flashes.

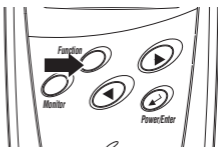

2. Press [**▲**] or [**▼**] to select the desired channel



3. Press [**←**] to confirm your selection, otherwise, the radio will automatically return to standby and the new channel will be displayed.

*Note: If you press and hold the [**▲**] or [**▼**], channel numbers will scroll rapidly.*

Note: If a step is not completed within 5 Secs., the UH048XR will automatically return to standby. Thus, you have to start again from the first step.

TO TRANSMIT AND RECEIVE

The **UH-048XR** uses the 40 UHF-CB Channels. For your reference a list of the available channels and corresponding frequencies is printed at the end of this manual.

1. The maximum RF transmit power of **UH-048XR** is 500 mWatts.
2. Before you transmit, listen for activity on the selected channel.
3. When the channel is clear, press and hold the [**PTT**] to transmit.

The TX indicators
 and
appear on
the LCD.

*Hold the radio with
microphone approximately
two inches in front of your
mouth with the antenna at
approximately 45° angle
away from your head. Speak in a clear, normal conversational voice.*

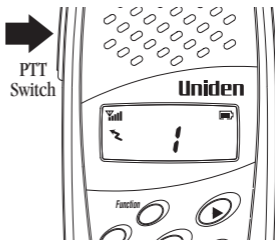

4. When you have finished speaking, release the **[PTT]** and listen for a response.



TX indicators will then disappear on the LCD.

The display shows  when a transmission is being received by your radio.

TO OPERATE IN DUAL-WATCH MODE

This feature allows you to monitor two different channels at the same time. If you pre-set any channel by this function, other than the current channel in use, the pre-set channel will be scanned every 0.5 seconds (together with the current channel) for any transmission.

Press **[Function]** button repeatedly until **[duu]**

appears in the large display and the dual-watch icon  flashes.

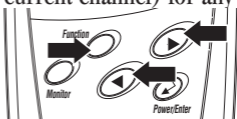

Press [▲] or [▼] to select the additional channel you wish to monitor. Press [←] to



confirm your selection and to activate dual-watch mode. Otherwise, the selected channel is automatically accepted if no key is pressed after 5 Secs.

Note: Pressing [Function] will stop Dual-Watch Mode operation.

SCANNING

This feature allows you to scan for an active channel and communicate with the party transmitting.

1. Press [Function] button until **SC** appears in the large display and the auto channel scan icon [↻] flashes.
2. Press [▲] or [▼] to select up or down.



Note: [▲] means scanning goes from lower to higher channel, [▼] means scanning goes from higher to lower channel.

3. Press [←] to confirm your selection and to activate the scan mode. Otherwise the status selected is automatically accepted if no key is pressed after 5 Secs.

CONTINUOUS TONE CODED SQUELCH SYSTEM (CTCSS)

CTCSS is a feature that allows a group to talk to each other without hearing other users on the same channel.

NOTE : Uniden discourages the use of CTCSS feature until the Australian Communications Authority (ACA) grants the use of CTCSS on CB frequencies.

Programming CTCSS Code

1. Press **[Function]** button repeatedly until “[ctc]” appears in the large display.
2. Press **[▲]** or **[▼]** to select the desired code.
3. Press **[←]** to confirm your selection. Otherwise, the code selected is automatically accepted if no key is pressed after 5 Secs.

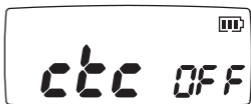

Setting CTCSS to “OFF” allows the radio to receive all transmissions on the selected channel regardless of CTCSS tone.

On the example below only radio 1 and 9 can communicate or hear each other because they are using the same or common CTCSS code.

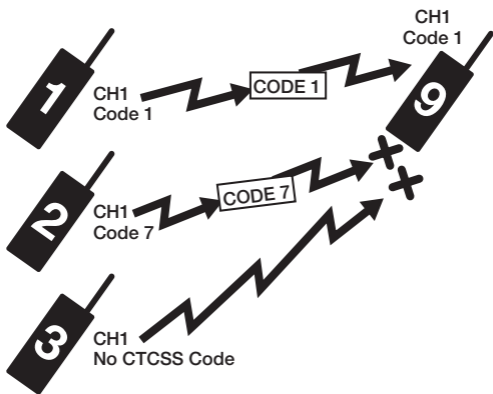

CTCSS Tone Display

This feature allows you to select the preferred display format for the CTCSS code setting. If frequency *F_rE₉* was chosen, then the display in the CTCSS will be shown as frequency. However, if the number *no* was chosen, then the code number will be displayed in CTCSS function.

1. Press **[Function]** button until *t0n* appears in the large display.
2. Press **[▲]** or **[▼]** to change the format.



3. Press [←] to confirm your selection. Otherwise, the displayed state is automatically accepted if no key is pressed after 5 Secs.

VOICE ACTIVATED (VOX)

VOX feature enables user to transmit automatically by speaking on the microphone without pressing the PTT switch.

To activate VOX:

1. Press **[Function]** button until “[VO]” appears in the large display and the VOX icon [] flashes.

2. Press [▲] or [▼] to change the sensitivity or deactivate VOX.



3. Press [←] to confirm your selection. Otherwise, the status is selected automatically if no key is pressed after 5 Secs.

Note: A headset microphone (not supplied) can be used with this function.

VOX Recovery Time

This is the amount of time the UH048XR will hold the transmission before it starts receiving signals.

To set the timing:

1. Press **[Function]** button until “[Udt]” appears

in the large display and the VOX icon [] flashes.

2. Press [▲] or [▼] to select the delay time.



3. Press [←] to confirm your selection. Otherwise the selected time is automatically accepted when no key is pressed after 5 Secs.

AUTO KEYLOCK

This feature prevents accidental channel change and disturbance to the preferred settings of the user. Auto Key Lock temporarily disables the UP, DOWN and ENTER buttons.

To activate Automatic Keylock:

1. Press [Function] button until "[ALo]" appears in the large display and the key-lock icon  flashes.

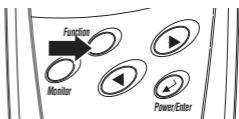

2. Press [▲] or [▼] to select Auto option.



3. Press [←] to confirm your selection. Otherwise, the selected option is automatically accepted if no key is press after 5 Secs.

The radio momentarily beeps as  appears on display and [▲] or [▼] and [←] immediately goes into auto lock if no key is pressed within 10 Secs.

To deactivate keylock temporarily, press and hold [Function] until  disappears. Keys will go into auto lock again if no key is pressed within 10 Secs.



To deactivate permanently:

1. Press and hold **[Function]** button until  disappears in the display.
2. Follow steps 1 to 3 for Activating Keylock but select off in step 2.

CALL MELODY

This feature provides 7 selectable user call ringer melodies to alert you of a calling party.

To set call melody:

1. Press **[Function]** button until  and the CAL icon  appear on the display . The current melody number appears in the small display and the melody is played.
2. Press [▲] or [▼] to select the melody.
3. Press [←] to confirm your selection. Otherwise, the selected melody is automatically accepted if no key is press after 5 Secs.



To use Call Melody:

Press **[PTT]** twice. Call Melody will be heard on user's radio and on all radios using the same channel.

MONITOR

This feature enables users to listen in for weak signals on the current channel at the press of the **[Monitor]** button.

To use monitor,

- For brief listening, press **[Monitor]**
- For continuous

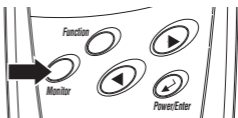

listening. Press and hold **[Monitor]** for 2

sec. A tone beep will be heard and the receiver circuit will stay open, letting in both the noise & weak signals.

- Display shows  icon.
- To return to normal receive mode press **[Monitor]** or **[PTT]** button.



BATTERY LEVEL DISPLAY

The  icon in the top right hand corner of the screen indicates the *UH-048XR* current battery voltage level at all times. The battery level is displayed in 3 levels:

LEVEL 3
Battery 100% full



LEVEL 2
**Battery approx
70% capacity**



LEVEL 1
**Battery approx
30% capacity**



Almost Empty



BATTERY CHARGE

Warning Notice! This UH048XR is designed to charge Ni-Cd batteries only.

Use only the power Adaptor AAD-048S with 4 AAA size Ni-Cd batteries.

Turn the power off. Follow charging set-up below.

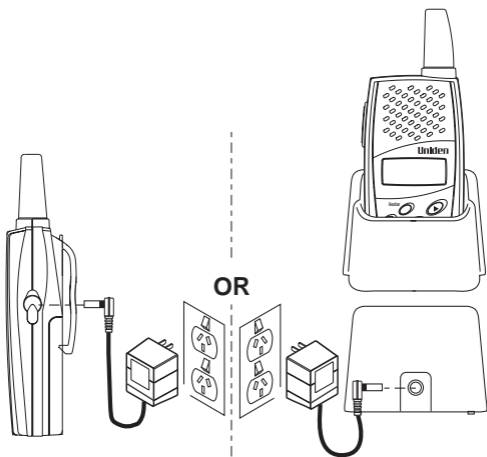

Note 1: To fully charge the battery, leave the AC Adaptor (AAD-048S) charging for 14-16 hours.

Note 2: Disconnect the AC Adaptor from the unit when charging is completed.

Note 3: When using the Desk Top Charger, the UH048XR must be placed with its front view facing the short part of the charger.



Charging batteries other than NiCd may damage the radio.

UHF CHANNELS & FREQUENCIES

Ch.	Freq.	Usage	Ch.	Freq.	Usage
01	476.425	Simplex	21	476.925	Simplex
02	476.450	Simplex	22	476.950	Simplex
03	476.475	Simplex	23	476.975	Simplex
04	476.500	Simplex	24	477.000	Simplex
05	*476.525	Simplex	25	477.025	Simplex
06	476.550	Simplex	26	477.050	Simplex
07	476.575	Simplex	27	477.075	Simplex
08	476.600	Simplex	28	477.100	Simplex
09	476.625	Repeater	29	477.125	Simplex
10	476.650	Repeater	30	477.150	Simplex
11	#476.675 Emergency Channel	Back-up	31	477.175	Simplex
12	476.700	Repeater	32	477.200	Simplex
13	476.725	Repeater	33	477.225	Simplex
14	476.750	Repeater	34	477.250	Simplex
15	476.775	Repeater	35	477.275	Simplex
16	476.800	Repeater	36	477.300	Simplex
17	476.825	Repeater	37	477.325	Simplex
18	476.850	Repeater	38	477.350	Simplex
19	476.875	Repeater	39	477.375	Simplex
20	476.900	Repeater	40	477.400	Simplex

* Emergency calling for simplex operation

Please do not use this channel in non-emergency cases.

Back-up Emergency Channel

CTCSS CODES & FREQUENCIES

Code No.	Freq. (Hz)	Code No.	Freq. (Hz)	Code No.	Freq. (Hz)
00('oF')	OFF	13	103.5	26	162.2
01	67.0	14	107.2	27	167.9
02	71.9	15	110.9	28	173.8
03	74.4	16	114.8	29	179.9
04	77.0	17	118.8	30	186.2
05	79.7	18	123.0	31	192.8
06	82.5	19	127.3	32	203.5
07	85.4	20	131.8	33	210.7
08	88.5	21	136.5	34	218.1
09	91.5	22	141.3	35	225.7
10	94.8	23	146.2	36	233.6
11	97.4	24	151.4	37	241.8
12	100.0	25	156.7	38	250.3

ACCESSORIES

- AC Adaptor (AAD-048)
- Desk Top Charger (DTC-048)

OPTIONAL ACCESSORIES

- Speaker Microphone (SM-048)
- Headset Microphone (HM-048)

TECHNICAL SPECIFICATIONS

General

Channels	Transmit 40 Receive 40
Oper. Temp.	0°C - +55°C
Antenna	Fixed
Microphone	Built-in Electret type
Display	Liquid Crystal Display
Speaker	Round Type
Power Source	4 x AAA Size Batteries
Size	(without antenna) 99(H) x 51.7(W) x 24.4(D)mm
Weight	134g (with Antenna & Battery)
Operating Time at Batteries)	30 hrs (1000mAH Alkaline
5-5-90 Duty Cycle Batteries)	20 hrs (600mAH Ni-Cd

Transmitter

Frequency Control	Phase Locked Loop
Frequency Range	476.425 to 477.4 MHz
Frequency Stability	±5 ppm
Power Output	0.5W
Spurious Emissions	-40 dBm
Current Drain	320mA

Receiver

Receiver Type	Dual Conversion Super Heterodyne Phase Locked Loop System for Local Oscillator
Frequency Range	476.425 to 477.4 MHz
Sensitivity @ 20 dB SINAD	0.28 μ V
Squelch Sensitivity	0.19 μ V (Threshold)
Audio Frequency Response (ref: 1KHz, \pm 3KHz Dev.)	500Hz, 5dB 2000Hz, -6dB
Selectivity	60dB
Hum & Noise Ratio	40dB
Audio Output Drain	0.2W (10% THD)
Current Drain	150 mA 50mW output

Specifications shown are typical and subject to change without notice.

WARRANTY

UNIDEN UH-048XR UHF CB RADIO

Limited One Year Warranty

Note: Please keep your sales docket as it provides evidence of warranty.

Warrantor: Uniden Australia Pty Limited ACN 001 865 498
Uniden New Zealand Limited

Elements of Warranty: Uniden warrants to the original retail owner for the duration of this warranty, its UH-048XR UHF CB Transceiver Radio (hereinafter referred to as the Product) to be free from defects in materials and craftsmanship with only the limitations or exclusions set out below.

Warranty Duration: This warranty to the original retail owner only, shall terminate and be of no further effect ONE (1) Year after the date of original retail sale. This warranty will be deemed invalid if the product is; (A) Damaged or not maintained as reasonable and necessary, (B) Modified, altered or used as part of any conversion kits, subassemblies, or any configurations not sold by Uniden, (C) Improperly installed, (D) Repaired by someone other than an authorised Uniden Repair Agent for a defect or malfunction covered by this warranty, (E) Used in conjunction with any equipment or parts or as part of a system not manufactured by Uniden, (F) Installed, programmed or serviced by anyone other than an authorised Uniden Repair Agent, or (G) Where the Serial Number label of the product has been removed or damaged beyond recognition.

Parts Covered: This warranty covers for 1 year, the UHF CB Transceiver Unit only. Accessories: Belt CLip and Wrist Strap are covered for 90 days.

Statement of Remedy: In the event that the product does not conform to this warranty at any time while this warranty is in effect, the warrantor at its discretion, will repair the defect or replace the product and return it to you without charge for parts and service. This warranty does not cover provide for the reimbursement or payment of incidental or consequential damages.

Warranty card: If a warranty card has been included with this product, please fill it in and return it to us within 14 days of purchase.

Procedure for obtaining performance or warranty: In the event that the Product does not conform to this warranty, the Product should be shipped or delivered, freight prepaid, with evidence of original purchase, (eg. a copy of the sales docket), to the warrantor at:

UNIDEN AUSTRALIA PTY LIMITED

Service Division

345 Princes Highway,

Rockdale, NSW 2216

Ph (02) 9599 3577

Fax (02) 9599 3278

Toll Free 1300 366 895

UNIDEN NEW ZEALAND LTD

Service Division

150 Harris Road,

East Tamaki, Auckland

Ph (9) 273 8383

Fax (9) 274 4253

Toll Free 0800 4UNIDEN

4864336

Customers in other states should ship or deliver the Product freight pre-paid to the nearest Uniden Authorised Repair Centre. (Contact Uniden for the Warranty Agent nearest you.)

CONTROLS & INDICATORS

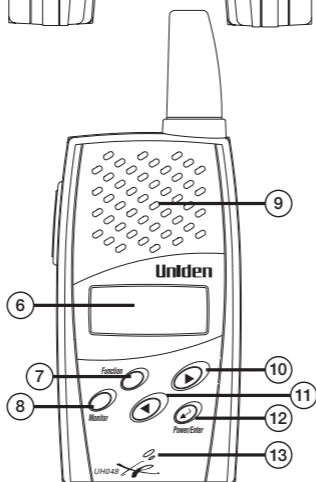
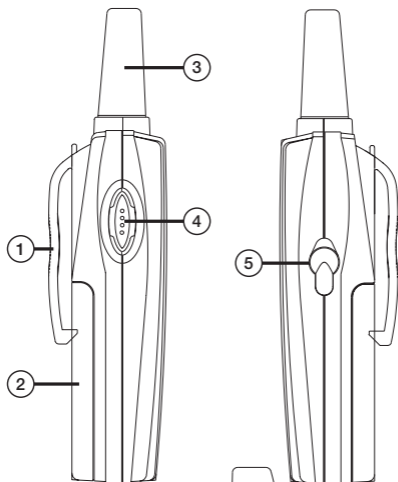

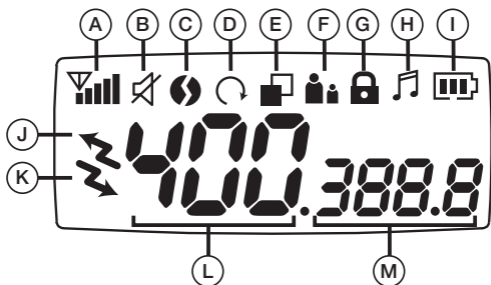

- | | |
|--------------------------------|----------------------------|
| A. Signal Strength Indicator | G. Keylock Indicator |
| B. Monitor Indicator | H. Melody Indicator |
| C. CTCSS Indicator | I. Battery Level Indicator |
| D. Auto Channel Scan Indicator | J. TX Indicator |
| E. Dual Watch Scan Indicator | K. RX Indicator |
| F. VOX Indicator | L. Channel Indicator |
| | M. CTCSS Code or Frequency |

-
- | | |
|--------------------------------------|----------------------------------|
| 1. Detachable Belt Clip | 8. Monitor Button |
| 2. Battery Cover | 9. Built-in Speaker |
| 3. Antenna | 10. Down Button & Volume Control |
| 4. PTT (Push-to-talk) Button | 11. Up Button & Volume Control |
| 5. External Mic/Speaker/Charger Jack | 12. Power On/Off & Enter Button |
| 6. LCD Display | 13. Built-in Microphone |
| 7. Function Button | |

Uniden

© 2000 Uniden Australia Pty Limited/
Uniden New Zealand Limited

Free Manuals Download Website

<http://myh66.com>

<http://usermanuals.us>

<http://www.somanuals.com>

<http://www.4manuals.cc>

<http://www.manual-lib.com>

<http://www.404manual.com>

<http://www.luxmanual.com>

<http://aubethermostatmanual.com>

Golf course search by state

<http://golfingnear.com>

Email search by domain

<http://emailbydomain.com>

Auto manuals search

<http://auto.somanuals.com>

TV manuals search

<http://tv.somanuals.com>