

UH-052XR

Operating Guide



Uniden

WARNING!

- The **UH052XR** is splashproof* only when both the antenna and the battery are properly attached.
- Do not operate the transmitter of any radio equipment unless all the Radio Frequency (RF) connectors are secured and any open connectors are properly terminated.
- Do not operate the transmitter of any radio equipment near electrical blasting caps or in an explosive atmosphere.
- Do not let children operate any transmitter-equipped radio equipment unless supervised.
- Have your radio equipment serviced by a qualified technician.
- Do not operate the transmitter of any radio equipment with the antenna touching or close to the eyes, face, or exposed body parts.

NICKEL-CADMIUM BATTERY PACK WARNING

- This equipment contains a Nickel-Cadmium Battery Pack.
- The Nickel-Cadmium Battery Pack contained in this equipment may explode if disposed of in a fire.
- Do not short-circuit the Battery Pack.
- Do not charge the Nickel-Cadmium Battery Pack used in this equipment in any charger other than the one designed to charge this Battery Pack. Using another charger may damage the Battery Pack or cause the Battery Pack to explode.
- Nickel-Cadmium batteries must be disposed of properly.



The exclamation point within an equilateral triangle is intended to alert the user to the presence of important operating and maintenance (servicing) instructions in the literature accompanying the appliance.

**The "Splashproof" characteristic of this device complies to US Military Standard 810E Method 506.3, Rain II*

CONTENTS

Introduction

Features	1
Technical Support & Service	2
Included in your UH-052XR Package	3

Getting Started

Attaching the Antenna	4
Attaching the Battery Pack	4
Charging the Battery Pack	4
Battery Charge Indicator	5

Operation

Power on/off	6
Volume	6
Selecting Channel	6
Squelch	7
To Transmit and Receive	8
Using a Repeater Channel	9
To Operate UH-052XR in Duplex Mode	10
Scanning	10
Open Scan	10
Group Scan	11
Programming Scan Channels	12
Priority Channels	12
Drop-Out Delay	12
Built-in CTCSS	12
Built-in VOX	13
Power Save	15
Backlight	15
Splashproof	15
Keypad Lock	15
Sending Call Tones	15
Busy Channel Lock-out	16
Monitor	16
Battery Level Display	17

UHF Channels and Frequencies	18
---	-----------

CTCSS Codes and Frequencies	19
--	-----------

Optional Accessories	19
---------------------------------------	-----------

Technical Specifications	20
---	-----------

Warranty	22
---------------------------	-----------

Controls & Functions	23
---	-----------

INTRODUCTION

The **UH-052XR** is a splash proof, portable two-way UHF-CB radio. It is compact, rugged and fits easily in your hand. This hand held UHF radio will give you consistent, outstanding performance in virtually all conditions and situations. To ensure that you get the most from the **UH-052XR's** features, please read this operating guide carefully before using the unit.

FEATURES

- Splash proof*
- 40 Channels
- 5W/1W Switchable RF Output Power
- LCD Display
- Duplex Capability
- Group Scan
- Open Scan
- Monitor
- Built in Continuous Coded Squelch System (CTCSS)
- Busy Channel Lock Out Function
- Built in Voice Activated Function (VOX)
- LCD and Keypad Back Light
- Auto Power Save
- Battery Level Indicator
- Battery Charge Indicator
- Built in Keypad Lock

**The "Splashproof" characteristic of this device complies to US Military Standard 810E Method 506.3, Rain II*

TECHNICAL SUPPORT AND SERVICE

Should you find it desirable or necessary to service your **UH-052XR**, we suggest you contact the Uniden dealer where you purchase your radio. Your dealer will be able to assist you with the complete service information.

If you require service that is within the terms of your warranty, you should present a copy of your receipt to your dealer to authenticate your claim.

If you find it inconvenient to obtain service assistance from a dealer, please pack your radio in a suitable packaging that will provide adequate protection to your radio. Enclose a note describing the problem, a copy of your receipt, and send it prepaid to:

AUSTRALIA:

Uniden Australia Pty Ltd
Customer Service Division
345 Princes Highway
Rockdale NSW 2216
Ph. (02) 9599-3355
Fax. (02) 9599-3278
Toll Free 1300 366 895

NEW ZEALAND:

Uniden New Zealand Ltd
Customer Service Division
150 Harris Road
East Tamaki, Auckland
Ph. (9) 273 8383
Fax. (9) 274 4253
Toll Free 0800 4 UNIDEN
0800 4 864336

Caution: *Changes or modifications to this product not expressly approved by Uniden; or operation of this product in any way other than as detailed by this Operating Guide, can void your warranty and authority to operate this product.*

INCLUDED IN YOUR UH-052XR PACKAGE

UH-052XR

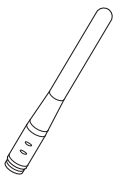

Antenna

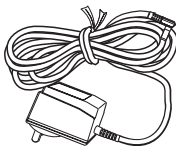

AC Adaptor (AAD-052S)



Wrist Strap

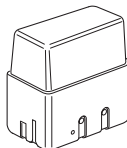

Battery BP-052 (7.2V, 950mAh)



Operating Guide

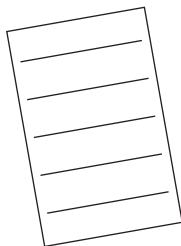

Product Registration Card

Note: If any of these items are missing from the box, contact your Uniden Dealer.

GETTING STARTED

ATTACHING THE ANTENNA

Attach the antenna to the **UH-052XR** following direction as indicated below. Be sure the antenna is firmly seated.

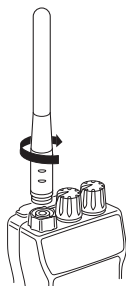

ATTACHING THE BATTERY PACK

1. Slide the battery pack onto the bottom of the radio.



2. Use a coin to turn the screw that connects the battery pack to the **UH-052XR**. Be sure the battery pack fits tightly against the **UH-052XR** body.

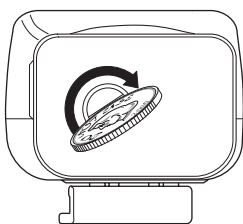

CHARGING THE BATTERY PACK

Your UHF CB radio is powered by a specially designed nickel-cadmium battery pack.

Before operating the **UH-052XR**, charge the battery pack for 15 hours using the ac adaptor provided in this package.

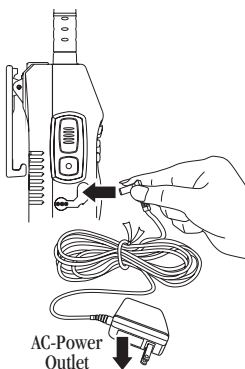

BATTERY CHARGE INDICATOR

When charging, the CHG icon appears on the display.



Note :

1. *Transmit Operation is disabled when **UH-052XR** is being charged.*
2. *A single tone is emitted by the radio and **CHG** is displayed to indicate that it has started charging.*
3. *When the battery is totally empty, **CHG** icon blinks or the display may totally disappear; the radio will be unable to receive any signal and all the keys are disabled. In this case, it is best to switch OFF the radio to help facilitate charging.*

***UH-052XR** will return to normal operation once enough power level is established.*

Note: If you are unable to charge a fully discharged battery, switch OFF the radio to avoid further discharging. When possible, recharge the batteries for the recommended time period.

OPERATION

- When you press any key (except PTT), a short tone sounds.
- See the Controls and Indicators page at the back of this operating guide for button and key operations.

POWER ON/OFF

To turn the unit **ON**, rotate the **[ON/OFF VOL]** knob clockwise until a “click” is heard. A channel number and battery level should appear on the display.

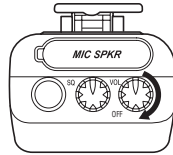

To turn the unit **OFF**, rotate the **[ON/OFF VOL]** knob counter-clockwise until a “click” is heard. The display will disappear.

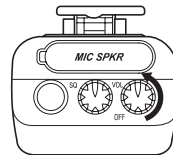

VOLUME

Rotate the **[ON/OFF VOL]** knob clockwise or counter-clockwise to adjust speaker volume to desired listening level.

*Note: If no sound is heard, temporarily unmute the radio by briefly rotating the **[SQ]** until you hear the receiver's background noise. Rotate **[ON/OFF VOL]** to desired level. When finished, rotate **[SQ]** until noise disappears.*

SELECTING CHANNEL

Press **[▲]** or **[▼]** to select the desired channel.

*Note: If you press and hold the **[▲]** or **[▼]**, channel numbers will scroll rapidly.*

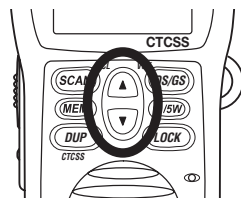

SQUELCH

The squelch is used to eliminate any annoying background noise when there are no signals present.

Think of squelch as a gate. Turn **[SQ]** fully clockwise. This raises the "Squelch Gate" so high that only the very strong signals can get through.

(Make sure to first select a channel not in use before setting the squelch in your UH-052XR UHF-CB radio.)

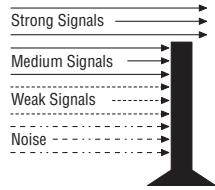

Turn **[SQ]** fully counter clockwise until you hear a hiss. This opens the "Squelch Gate" so that everything gets through - noise, weak signal, and strong signals.

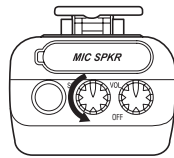
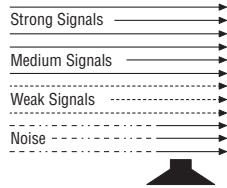

To set the "Squelch Gate" to the desired level, turn **[SQ]** counter-clockwise until you hear noise. Then turn the **[SQ]** clockwise just until the noise stopped. Now only the desired signal can get through.

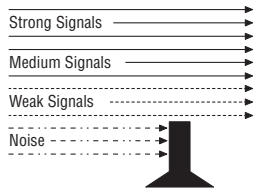

*Note: If an incoming signal is very weak there is a possibility that you will have a choppy or broken reception, due to the sensitivity of the squelch. In this case, simply rotate the **[SQ]** clockwise until the weak signal is heard clearly.*

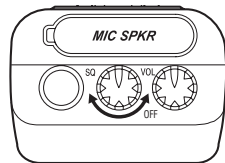

TO TRANSMIT AND RECEIVE

The **UH-052XR** uses the 40 UHF-CB Channels. For your reference a list of the available channels and corresponding frequencies is printed at the end of this manual.

1. The maximum RF transmit power of **UH-052XR** is 5 watts.

To switch to low power, press the **[1/5W]**. **LOW** appears on the LCD.

To switch back to higher power, press the **[1/5W]** again. **LOW** indicator disappears from the LCD.

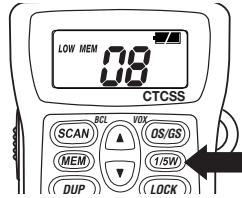

2. Before you transmit, listen for activity on the selected channel.

3. When the channel is clear, press and hold the **[PTT]** to transmit. **TX** appears on the LCD.

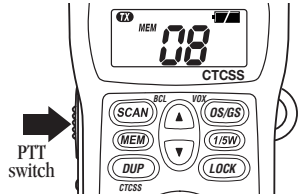

Hold the radio with microphone approximately two inches in front of your mouth with the antenna at approximately 45° angle away from your head. Speak in a clear, normal conversational voice.

4. When you have finished speaking, release the **[PTT]** and listen for a response. **TX** indicator then disappears on the LCD.

The display shows **BUSY** when a transmission is being received by your radio.



USING A REPEATER CHANNEL

UHF CB Repeaters are used to retransmit or relay your signal. Repeaters will extend the range of your radio and overcome the shielding effect caused by solid obstructions.

In normal Simplex operation, your radio transmits on one particular frequency and receives on that same frequency. If there is a barrier (i.e. a Tall Building) that partially blocks your transmitted signal, the possibility of the other radio receiving the signal is very slim. Valleys, metallic structures, etc., tend to act as a screen between radios.

Standard Operation without the aid of a Repeater Station



Operation with the aid of a Repeater

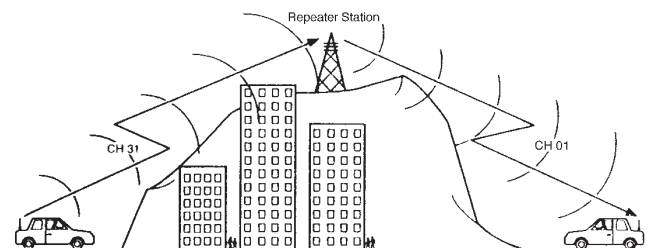

With Duplex operation, the signal coming from your radio is received by the Repeater station and then re-transmitted at the same time on another channel.

Your **UH-052XR** is designed with duplex capability on Channels 1 to 8. When any of these channels are set to operate in duplex mode during transmission, the **UH-052XR** automatically sends the signal at a frequency 30 channels above the original in order to access the repeater station. After transmitting, the radio reverts back to its original operating frequency.

For example:

1. CH01 is on Duplex Mode
 - will Receive on CH01 but Transmit on CH31
2. CH02 is on Duplex Mode
 - will Receive on CH02 but Transmit on CH32, etc....

Refer to Duplex Operating Mode table on the last page.

TO OPERATE UH-052XR IN DUPLEX MODE

Eg. CH01 is being used in your area for repeater use.

Press **[DUP]** momentarily. The **DUP** icon appears.

Press **[DUP]** again to deactivate the duplex operation. **UH-052XR** will return to simplex operation.

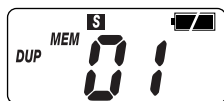

SCANNING

The **UH-052XR** has two types of scanning; Open Scanning (OS) and Group Scanning (GS), giving you flexibility and allowing you to use the radio more effectively.

Scanning allows you to search for active channels programmed in the OS or GS memory.

To initiate scanning,

1. Assuming the unit is on CH17 when switched on.
2. Press **[SCAN]** and scanning starts. Scan icon flashes during scanning

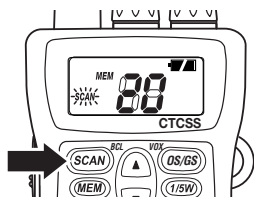
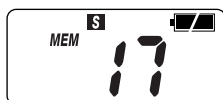

1. **Open Scan (OS) Mode** (the absence of GS icon indicates that the unit is on OS mode)

Allows continuous scanning of channels stored in the Open Scan (OS) memory. If an active channel is found, scanning will stop on that channel.

Note: The factory has preprogrammed all the 40 UHF channels into the Open Scan channel memory. However, you can change or customise the channels by following the steps on programming Scan Channels on page 12.

Example. CH40 becomes active

If the received signal ceases, the unit will wait for at least 3 seconds for the signal to return, otherwise scanning resumes.

To skip the active channel, press **[MEM]** momentarily. Scanning resumes.

To deactivate SCAN, press the **[SCAN]** or **[PTT]**.

Note:

1. If **SCAN** is deactivated while in an active channel, the UH-052XR will stay on that active channel. If no other channels are active, the UH-052XR will reinstate the starting channel.
2. Pressing **[CTCSS]** for 1.5 Secs. Will deactivate Open Scanning and activate CTCSS Scanning.
3. Pressing **[OS/GS]** will switch to Group Scanning.

2. Group Scan (GS) Mode

Allows you to monitor a Priority Channel while scanning.

To use GS Mode Scanning, press the **[OS/GS]** key. **GS** icon appears on the display.

GS Scanning checks the Priority channel activity regularly.

If the Priority channel becomes active the radio will stay on that channel for as long as the signal is present. If the received signal ceases, Priority scanning continues after 3 seconds.

If scanning stops on a channel which is not a Priority Channel UH-052XR will continue monitoring the Priority Channel for activity while listening to the active one.

To deactivate **SCAN**, press the **[SCAN]** or **[PTT]**.

Note:

1. If **SCAN** is deactivated while it is tuned to an active channel, the UH-052XR will stay on that active channel. If none of the channels are active, the UH-052XR will reinstate the Priority channel.
2. If **GS** Scanning is initiated when there are no channels programmed in **GS** memory, an error tone will be heard and scanning will not start.
3. Pressing **[CTCSS]** for 1.5 Secs. Will deactivate Group Scanning and activate CTCSS Scanning.
4. Pressing **[OS/GS]** will switch to Open Scanning.

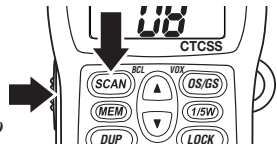
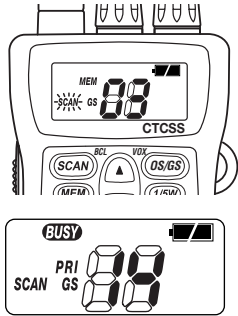

Programming Scan Channels

1. Select which Scanning Mode you wish to use on the channel
OS or GS Mode

Note: OS is indicated by the absence of the GS icon

2. Select the channel you want to store by pressing [▲] or [▼]
3. Press and hold [MEM] for 1.5 secs. to store. **MEM** icon appears and a short tone beep is heard.
4. To remove the channel from Memory, press and hold [MEM] for 1.5 secs. once more. Two successive beeps are heard and the **MEM** icon disappears.

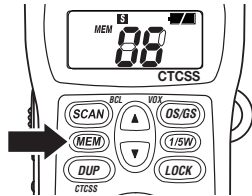
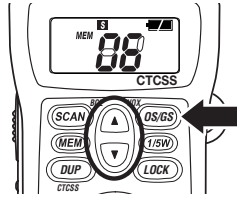

PRIORITY CHANNEL

The *Priority Channel* feature allows user to monitor one of 40 channels in the **UH-052XR**, monitoring it every 1.5secs during *Group Scanning*.

Choosing a *Priority Channel*

The starting channel, when *Group Scanning* is initiated, is always the *Priority Channel*. To change the priority channel setting while scanning, (eg. PRI Channel is CH17 (476.825 MHz))

- a. press [▲], to select a higher channel (scanning pauses)
- or
- b. press [▼], to select a lower channel



DROP-OUT DELAY

While scanning, the **UH-052XR** stops at a busy channel and receives a transmission. When the received signal is over, the unit will wait for 3 seconds for the return of the signal, otherwise, the radio resumes scanning.

ADVANCED FEATURES

- **Continuous Tone Coded Squelch System (CTCSS)** is a feature that allows a group to talk to each other without hearing other users on the same channel.

NOTE: Uniden discourages the use of CTCSS feature until the Australian Communications Authority (ACA) grants the use of CTCSS on CB frequencies.

Programming CTCSS Code

1. Select a desired channel to be used with **CTCSS**.
2. Press and hold [**CTCSS**] for 1.5 secs. CTCSS icon blinks.
3. Press [**▲**] or [**▼**] to select the desired CTCSS code.
4. Press [**CTCSS**] to save the selected code. **CTCSS** icon stops blinking.

NOTE: UH-052XR will return to standby mode after 10 secs. of no activity. CTCSS code can be programmed on every channel. There are 38 available CTCSS tone per channel.

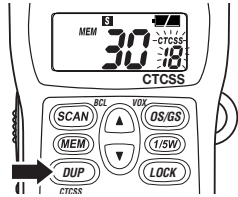

CTCSS Scan Operation

1. Press [**SCAN**] to start scanning (GS or OS) mode.
2. Press and hold [**CTCSS**] to change to CTCSS scan mode.
3. During scanning and a signal is sensed on a CTCSS CH, the **UH-052XR** stops for about 400msecs (decode time) to decode the CTCSS code. If there is no code or the receive code does not match the one programmed on the unit, the unit resumes scanning.

On the example below only radio 1 and 9 can communicate or hear each other because they are using the same or common CTCSS code.

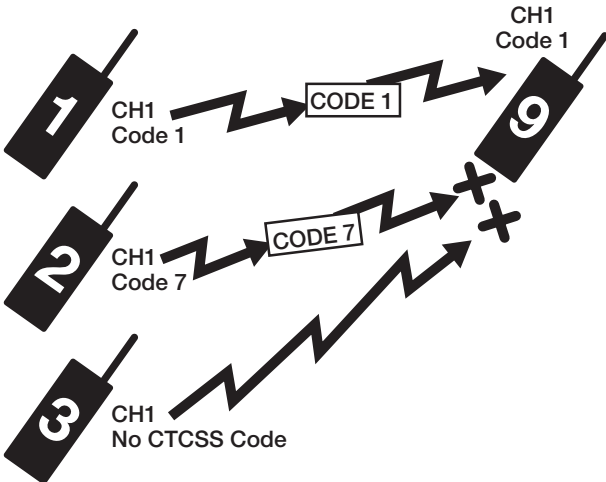

- **Built-in Voice Activated Circuit (VOX)** feature enables user to transmit automatically by speaking on the microphone of the VOX headset (not supplied) without pressing the PTT switch.

NOTE: VOX feature will not work without the Headset Microphone. Built in [PTT] of UH-052XR is temporarily disabled, however accidental pressing of [PTT] will cause the unit to transmit briefly.

To activate VOX

1. Press and hold [VOX] for 1.5 secs. “VOX” icon blinks.
2. Press either [▲] or [▼] within 10 secs. to select the desired VOX level number (9 with the lowest sensitivity to 1 with the highest sensitivity).
3. Press [VOX] to save the selected level. “VOX” icon stops blinking.
4. Install VOX Headset (not supplied) to **UH-052XR**

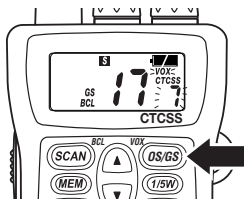

Installing VOX Headset

1. Remove SPEAKER MIC COVER.
2. Attach VOX headset mic by pushing down jack through to the speaker mic port of **UH-052XR** until it sits firmly on the radio.

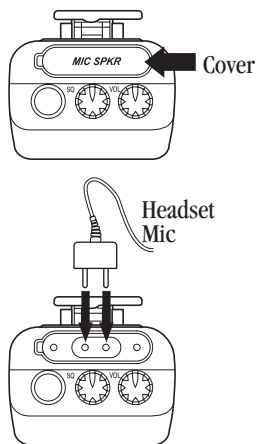

To De-activate VOX

1. Remove VOX Headset from **UH-052XR**.
2. Press and hold [VOX] for 1.5 secs until “VOX” blinks
3. Press [▼] repeatedly and until “of” displayed
4. Press [VOX] to save the setting. “VOX” icon disappears.



Note: changing the VOX sensitivity setting to “of” without removing the microphone will cause the unit to transmit continuously.

► POWER SAVE

Battery Save feature extends the battery life by switching the receiver circuit power ON and OFF. This feature automatically activates during stand by mode (RX mode without signal). A flashing  icon will appear on the display when the battery save feature is ON. It turns OFF automatically when a signal is present, and activates again 3secs after channel inactivity.

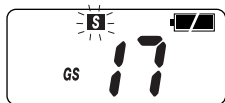

► BACK LIGHTING

The Liquid Crystal Display (LCD) and function keys are backlit for easy viewing at night or in low light situations. The back lighting automatically switches ON every time a key (except PTT) is pressed. It turns OFF 5secs after the last key is pressed.

► SPLASHPROOF

the *UH-052XR* provides splashproof construction for protection against tough weather conditions. The splashproof characteristic of this device complies to US Military Standard 810E Method 506.3, Rain II.

► KEYPAD LOCK

To prevent accidental entries, you can lock the keypad.

Press and hold the [LOCK] button until it beeps to activate Key Lock.  icon appears.

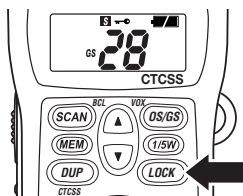

To unlock the keypad, press and hold the [LOCK] button again.  icon disappears.

Note: When the Key Lock is active, a warning beep will be heard if you attempt to press the keys.

► SENDING CALL TONES

The *UH-052XR* is equipped with two types of tones that user can use to alert other users or identify yourself prior to transmission. You can also apply the signal at the end of the transmission.

To use the Call Tones,

Press [▲] (for call tone A) or [▼] (for call tone B) while pressing the [PTT] switch. Call tone will be transmitted for 3 seconds. (You will also hear this tone from your radio as well).

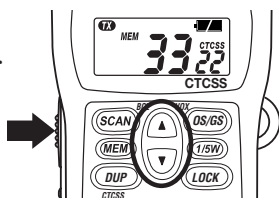

➤ BUSY CHANNEL LOCK-OUT(BCL)

This feature prevents accidental transmission on a busy channel.

This is recommended on channels where CTCSS is being used. If the channel is “active” and the signal is coming from a non or different CTCSS code user the BCL feature will prevent you from transmitting.

To activate BCL

Press and hold **[BCL]** for 1.5 secs until “BCL” appears on display.

To De-activate BCL

Press and hold **[BCL]** for 1.5 secs. until “BCL” disappears from the display.

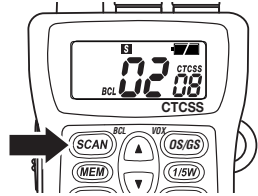

➤ MONITOR

This feature enables users to listen in for weak signals on the current channel at the press of a button.

To use monitor,

- For brief listening, press **[MON]**
- For continuous listening. Press and hold **[MON]** for 2 sec. A two tone beep will be heard and the receiver circuit will stay open letting in both the noise & weak signals.
- Display shows **MON** and **BUSY** icons.
- To return to normal receive mode press **[MON]**, **[PTT]** **[▲]** or **[▼]**.

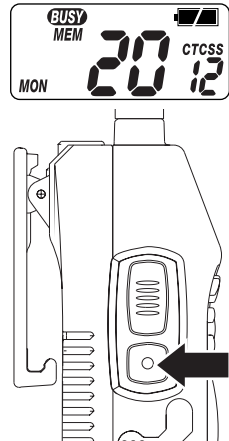

► BATTERY LEVEL DISPLAY

The  icon in the top right hand corner of the screen indicates the *UH-052XR* current battery voltage level at all times. The battery level is displayed in 4 levels:

LEVEL 4
Battery 100% full

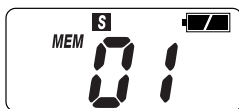

LEVEL 3
Battery approx 50% capacity

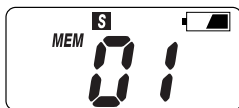

LEVEL 2
Low Battery

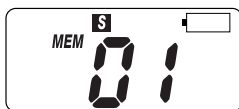

LEVEL 1 (flashing)
Empty Battery

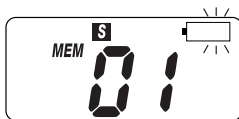

Note:
When [PTT] SW is pressed at Level Empty, battery icon and channel number will flash

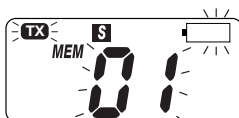

UHF CHANNELS & FREQUENCIES

Ch.	Freq.	Usage	Ch.	Freq.	Usage
01	476.425	Simplex/Duplex	21	476.925	Simplex
02	476.450	Simplex/Duplex	22	476.950	Simplex
03	476.475	Simplex/Duplex	23	476.975	Simplex
04	476.500	Simplex/Duplex	24	477.000	Simplex
05	*476.525	Simplex/Duplex	25	477.025	Simplex
06	476.550	Simplex/Duplex	26	477.050	Simplex
07	476.575	Simplex/Duplex	27	477.075	Simplex
08	476.600	Simplex/Duplex	28	477.100	Simplex
09	476.625	Repeater	29	477.125	Simplex
10	476.650	Repeater	30	477.150	Simplex
11	#476.675	Back-up Emergency Channel	31	477.175	Simplex
12	476.700	Repeater	32	477.200	Simplex
13	476.725	Repeater	33	477.225	Simplex
14	476.750	Repeater	34	477.250	Simplex
15	476.775	Repeater	35	477.275	Simplex
16	476.800	Repeater	36	477.300	Simplex
17	476.825	Repeater	37	477.325	Simplex
18	476.850	Repeater	38	477.350	Simplex
19	476.875	Repeater	39	477.375	Simplex
20	476.900	Repeater	40	477.400	Simplex

* Emergency calling for both simplex and duplex operation

Please do not use this channel in non-emergency cases.

Back-up Emergency Channel

CTCSS CODES & FREQUENCIES

Code No.	Freq. (Hz)	Code No.	Freq. (Hz)	Code No.	Freq. (Hz)
00 ('oF')	OFF	13	103.5	26	162.2
01	67.0	14	107.2	27	167.9
02	71.9	15	110.9	28	173.8
03	74.4	16	114.8	29	179.9
04	77.0	17	118.8	30	186.2
05	79.7	18	123.0	31	192.8
06	82.5	19	127.3	32	203.5
07	85.4	20	131.8	33	210.7
08	88.5	21	136.5	34	218.1
09	91.5	22	141.3	35	225.7
10	94.8	23	146.2	36	233.6
11	97.4	24	151.4	37	241.8
12	100.0	25	156.7	38	250.3

OPTIONAL ACCESSORIES

- Battery (BP-052)
- VOX Headset (VM-052)
- Speaker Microphone (SM-050)
- AC Adaptor (AAD-052S)
- Cigarette Lighter Charger (CL-050)
- Battery Eliminator (BE-050)
- Standard Headset Microphone (HM-050)

SPECIFICATIONS

General

Channels	Transmit 40 (with Duplex Channel Support) Receive 40
Oper. Temp.	0°C - +55°C
Antenna	Flexible Whip
Microphone	Built-in Electret type
Display	Liquid Crystal Display
Speaker	8Ω 1 Watt
Power Source	BP-052 Rechargeable Nickel-cadmium Battery Pack 950mAh, 7.2V
Size	(without antenna) 150(H) x 55(W) x 40(D)mm
Weight	450g (with Antenna & Battery Pack)

Transmitter

Frequency Control	Phase Locked Loop
Frequency Range	476.425 to 477.4 MHz
Frequency Stability	±6 ppm
Power Output	5W (high)/ 1W (low)
Spurious Emissions	-65 dBc
Current Drain	1500mA (High)/650mA (low)

Receiver

Receiver Type	Dual Conversion Super Heterodyne Phase Locked Loop System for Local Oscillator
Frequency Range	476.425 to 477.4 MHz
Sensitivity @ 12 dB SINAD	0.22 μV
Squelch Sensitivity	0.19 μV (Threshold)
Audio Frequency Response	500Hz, 4.5dB (ref: 1KHz, ± 3KHz Dev.) 2000Hz, -6.5dB
Adjacent Channel Selectivity	55 dB
Hum & Noise Ratio	40 dB
Audio Output Drain	0.3W (10% THD)
Current Drain	Squelched 35 mA Max.Audio 150 mA

Charger

Std. Power Supply

AAD-052S

Input 230~240V AC, 50Hz

Output 9V, 210 mA

Approval No. V/00031

Specifications shown are typical and subject to change without notice.

WARRANTY

UNIDEN UH-052XR UHF CB RADIO

Australian One Year Warranty

Note: Please keep your sales docket as it provides evidence of warranty.

Warrantor: Uniden Australia Pty Limited ACN 001 865 498

Elements of Warranty: Uniden warrants to the original retail owner for the duration of this warranty, its UH-052XR UHF CB Transceiver Radio (hereinafter referred to as the Product) to be free from defects in materials and craftsmanship with only the limitations or exclusions set out below.

Warranty Duration: This warranty to the original retail owner only, shall terminate and be of no further effect ONE (1) Year after the date of original retail sale. This warranty will be deemed invalid if the product is; (A) Damaged or not maintained as reasonable and necessary, (B) Modified, altered or used as part of any conversion kits, subassemblies, or any configurations not sold by Uniden, (C) Improperly installed, (D) Repaired by someone other than an authorised Uniden Repair Agent for a defect or malfunction covered by this warranty, (E) Used in conjunction with any equipment or parts or as part of a system not manufactured by Uniden, (F) Installed, programmed or serviced by anyone other than an authorised Uniden Repair Agent, or (G) Where the Serial Number label of the product has been removed or damaged beyond recognition.

Parts Covered: This warranty covers for 1 year, the UHF CB Transceiver Unit only. All accessories: AC Adaptor, Wrist Strap, Battery and Antenna are covered for 90 days.

Statement of Remedy: In the event that the product does not conform to this warranty at any time while this warranty is in effect, the warrantor at its discretion, will repair the defect or replace the product and return it to you without charge for parts and service. This warranty does not cover provide for the reimbursement or payment of incidental or consequential damages.

Warranty card: If a warranty card has been included with this product, please fill it in and return it to us within 14 days of purchase. Your name and serial number of the product will then be registered in our database and this will help us process your claim with greater speed and efficiency should you require warranty service.

Procedure for obtaining performance or warranty: In the event that the Product does not conform to this warranty, the Product should be shipped or delivered, freight prepaid, with evidence of original purchase, (eg. a copy of the sales docket, to the warrantor at:

UNIDEN AUSTRALIA PTY LIMITED

Service Division

345 Princes Highway, Rockdale, NSW 2216

Ph (02) 9599 3100 Toll Free 1300 366 895 Fax (02) 9599 3278

UNIDEN NEW ZEALAND LTD

Service Division

150 Harris Road, East Tamaki, Auckland

Ph (9) 273 8383 Fax (9) 274 4253 Toll Free 0800 4 UNIDEN
0800 4 864996

Customers in other states should ship or deliver the Product freight pre-paid to the nearest Uniden Authorised Repair Centre. (Contact Uniden for the Warranty Agent nearest you.)

CONTROLS & INDICATORS

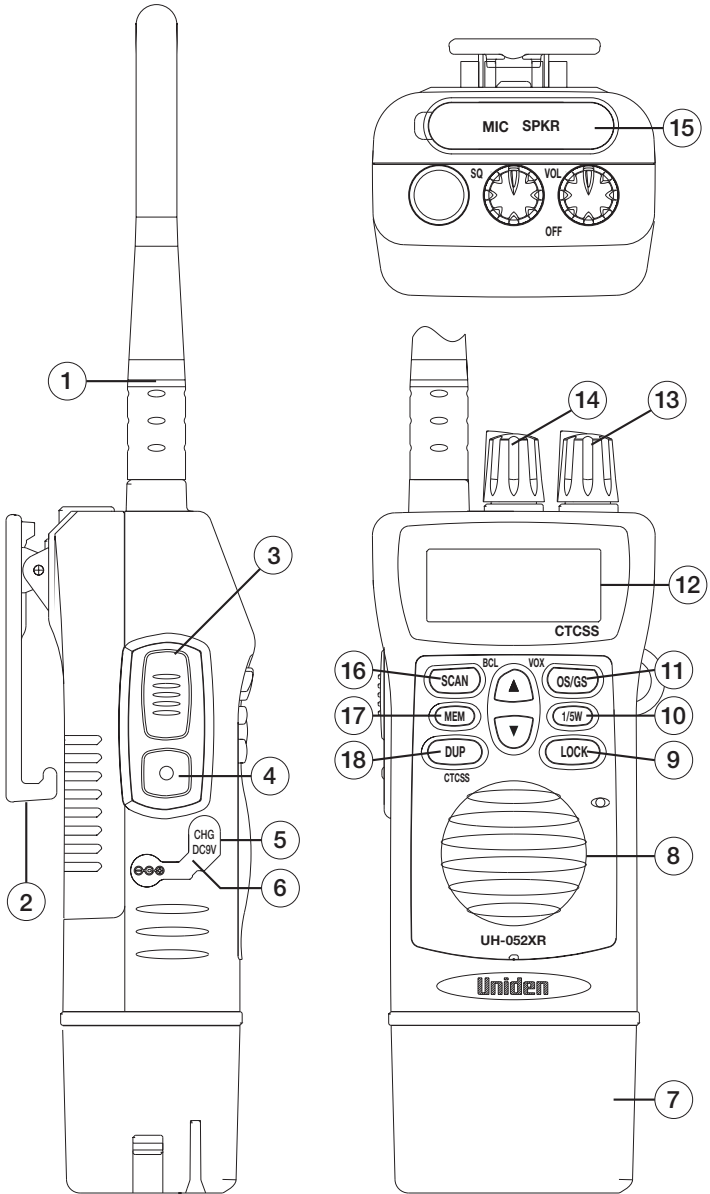

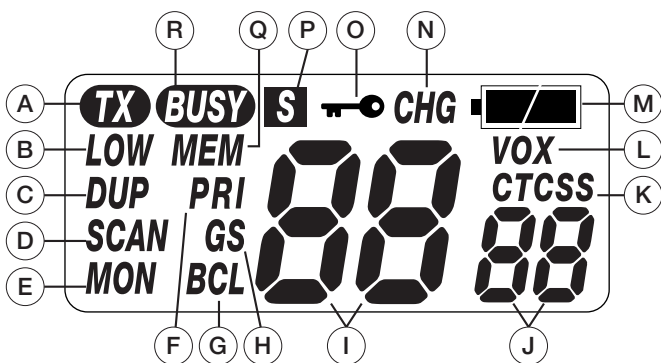

- | | |
|------------------------------|----------------------------|
| A. Transmit | K. CTCSS |
| B. 1W Power | L. VOX |
| C. Duplex Transmit | M. Battery Level Indicator |
| D. Scanning | N. Charging |
| E. Monitor | O. Key Lock |
| F. Priority | P. Power Save |
| G. Busy Channel Lock Out | Q. Memory |
| H. Group Scanning | R. Receive |
| I. Channel Numbers | |
| J. CTCSS Tone and VOX Levels | |

-
- | | |
|------------------------------|----------------------------|
| 1. Antenna | 11. OS/GS and VOX Key |
| 2. Belt Clip | 12. LCD Display |
| 3. PTT (Push-to-talk) Switch | 13. On/Off Volume Key |
| 4. Monitor Switch | 14. Squelch Key |
| 5. Charging Jack | 15. Speaker Mic Jack Cover |
| 6. Charging Jack Cover | 16. Scan and BCL Keys |
| 7. Battery | 17. Memory Key |
| 8. Speaker | 18. Duplex and CTCSS Key |
| 9. Lock Key | |
| 10. 1/5W Key | |

Uniden

© 2000 Uniden Australia Pty Limited/Uniden New Zealand Limited
Part Code UTZZ01872ZZ

Free Manuals Download Website

<http://myh66.com>

<http://usermanuals.us>

<http://www.somanuals.com>

<http://www.4manuals.cc>

<http://www.manual-lib.com>

<http://www.404manual.com>

<http://www.luxmanual.com>

<http://aubethermostatmanual.com>

Golf course search by state

<http://golfingnear.com>

Email search by domain

<http://emailbydomain.com>

Auto manuals search

<http://auto.somanuals.com>

TV manuals search

<http://tv.somanuals.com>