

MR550 Stationary Terminal



NOTICE

This unit is equipped with a Lithium-Ion battery pack, however it may not power-on due to battery discharge as a result of storage.

In case of the above situation, connect the unit to the MR550's power adapter and recharge unit for at least 16 hours to fully charge the battery.

The MR550 can operate normally for about 6 hours (without backlight) and can backup data for 7 days without external power.

Table of Contents

Chapter 1 - First Look	1
1.0 - Introduction	1
1.1 - MR550 and Accessories	2
1.2 - Tour of the MR550	3
1.3 - First Steps with the MR550	4
1.4 - First Operation of the MR550	5
Chapter 2 - Specifications	7
2.1 - CPU / Memory	7
2.2 - Input / Output	7
2.3 - Barcode / Symbology	7
2.4 - Magnetic Stripe Reader (MSR)	7
2.5 - Interface Port	8
2.6 - Power	8
2.7 - OS and Programming Tools	8
2.8 - Physical and Environmental Characteristics	8
2.9 - Pin Assignments	9
Chapter 3 - User Input	11
3.1 - Keypad	11
3.2 - Software Keyboard (WinCE Keyboard)	11
3.3 - Using Proximity, MSR, or Barcode Reader	12
Chapter 4 - Useful Programs	13
4.1 - Bar2Key	13
4.2 - BarSetup	14
4.3 - MSR and Proximity Reader Setup	15
4.3 - HockRS232 Event (Disable ActiveSync Driver for RS232 Port)	16

Chapter 1 - First Look

1.0 - Introduction

The MR550 series is a stationary terminal. It utilizes the Windows CE® 3.0 operating system, and incorporates an integral barcode slot reader, triple track magnetic stripe reader, Proximity reader or finger print reader. Its PCMCIA type II slot provides wire or wireless communication for LAN or WAN capability. It provides the user with a standard Windows-based environment for customizing and operating the device. The MR550 is well suited for Time & Attendance, Access Control, Loyalty program, Work-in-Process application, Price checking ,Food court system and many other data collection applications.

Chapter 1 - First Look

1.1 - MR550 and Accessories

After opening the box, please make sure all the following are present:



MR550



RS232 Cable



CD Manual



Getting Started
Guide

1.2 - Tour of the MR550

1.2.1 - MR550 Front

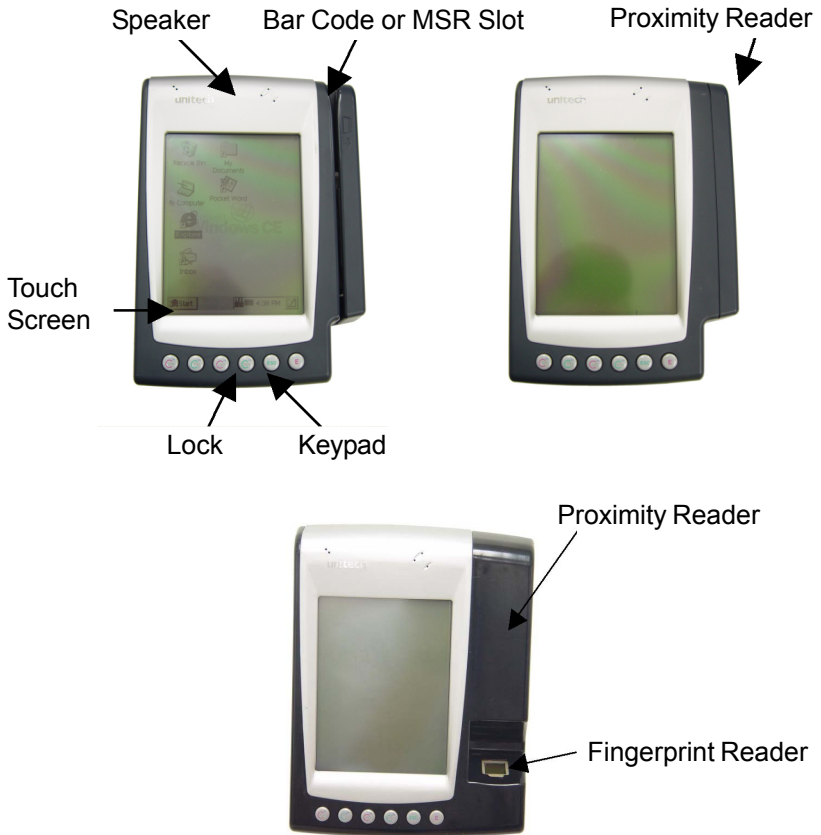

Chapter 1 - First Look

1.3 - First Steps with the MR550

NOTE: UPS battery can be used for normal operation when there is no main power and also as a data backup battery. Data entered should not be considered properly stored until the built-in backup battery has been adequately charged.

1. Insert key into lock and turn key with anti-clockwise direction.
2. Lift up back-plate to about 45°.



3. Ensure the UPS battery is connected via the white connector.

Use a pen or screw driver to push the dip switch to the side away from the connector (towards the bottom of the unit) to enable the backup battery.

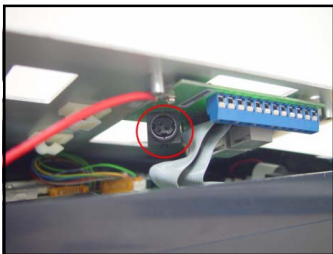
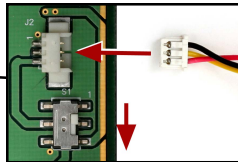
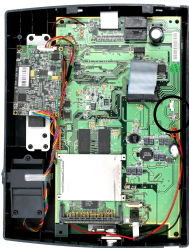

4. Plug the 13.5VAC Power Supply into the MR550's terminal block's AC connector on inner side of back-plate
Plug the Power Supply into your wall socket.
Charge the UPS battery for at least 16 hours.

1.4 - First Operation of the MR550

1.4.1 - Power-On the MR550

MR550 will automatically power-on when the 13.5VAC power adapter is plugged in. The MR550 welcome screen appears, which is soon replaced by the Windows CE screen.

1.4.2 - Calibrate the MR550

The screen to the right will automatically appear when the unit is first powered-on or after system reset.

The MR550 will prompt you to calibrate the unit by tapping a sequence of screen locations. Tap gently but firmly. When you have completed the series of taps, press the [ENT] key to confirm or press the [ESC] key to cancel.

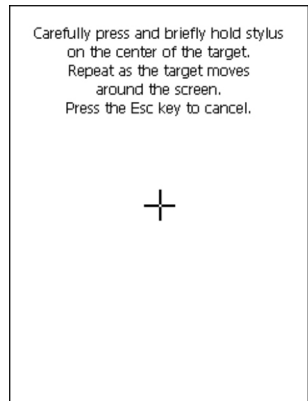

1.4.3 - Set Time Zone, Date, and Time

After Calibrating the MR550, the "Date/ Time Properties" dialog box will appear. Please follow below steps to set the date and time.

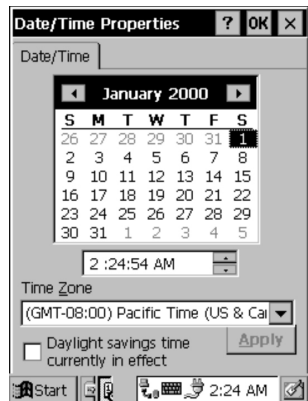

Chapter 1 - First Look

1.4.3.1 - Setting the Time Zone

Setting the correct time zone first is recommended because the system time will be automatically adjusted according to the difference between the original time zone and final time zone that you select.

Follow below steps to set it up.

1. Scroll down to see a list of cities.
2. Choose your location (or the nearest listed one).
3. Check the Daylight Saving check box, if necessary.
4. Tap the APPLY button.

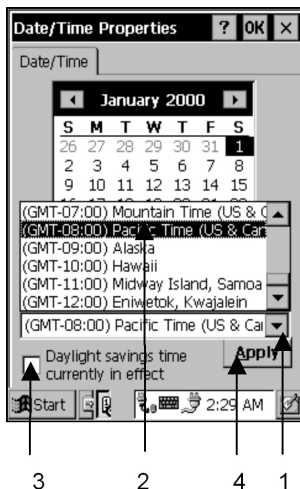

1.4.3.2 - Set the Year and Month

Tap Left or Right arrow to scroll the month

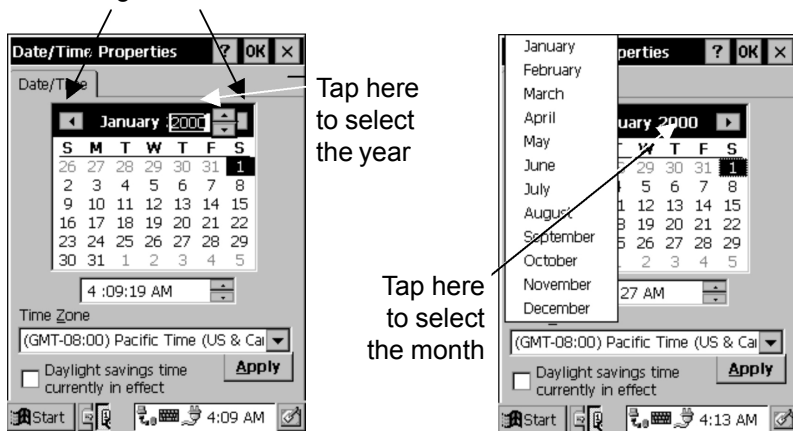

Or directly tap location of year or month to change the year or month setting.

1.4.3.3 - Exit Date / Time Properties

Tap **OK** or **X** (cancel) at upper-right corner to exit.

Chapter 2 - Specifications

2.1 - CPU / Memory

CPU	92 MHz 32 bits MIPS CPU. Built-in real time clock
Flash ROM	32MB for OS and application programs
SDRAM	32MB Built-in

2.2 - Input / Output

Keyboard	6 rubber keys, including F1~F4, ESC, and ENTER Software Alpha-numeric keyboard Software numeric keyboard
Audio output	Speaker with software controlled volume
Display	6 inches 240 x 320 pixels portrait type 4 gray scale, FSTN with touch screen LED backlight Contrast adjustable by software hotkey

2.3 - Barcode / Symbology

Symbology	Unitech's new generation decoder chip supports:			
	Codabar	Code 11	Code 32	Code 39
	Code 39 Full ASCII		Code 93	Code 128
	Delta Code		EAN-8/13	EAN128
	Interleaved 2 of 5	MSI / Plessey		Standard 2 of 5
	Telpen	Toshiba Code		UPC-A/E

2.4 - Magnetic Stripe Reader (MSR)

Track	Triple tracks
Measuring tap	PM50-7B (recording density 210BPI)
Tap speed	19 cm/sec (7.5 inch/sec)
Life	300,000 pass

Chapter 2 - Specifications

2.5 - Interface Port

RS232	Two RJ45 RS232C IDC type connectors: <ul style="list-style-type: none">• One supports full duplex asynchronous TX, RX, CTS, RTS, DTR, DSR communications and baud rate up to 115.2K bps.• One supports TX, RX, CTS, RTS
PC card	PCMCIA Type II slot
Digital Out	2 RELAY power with 270V AC/2A
Digital In	One photo-coupler input

2.6 - Power

Power input	External AC adapter @ 13.2VAC
UPS	1 cell Li-ion UPS battery @ 4.2V, 3000 mAH supports 6 hours operation (without communication and backlight) and 7 days data backup

2.7 - OS and Software Programming Tools

OS	Microsoft Windows CE version 3.0
Development Language	Microsoft Embedded Visual Tool for VB and VC programming

2.8 - Physical and Environmental Characteristics

Dimensions	8.46" (L) x 5.98" (W) x 1.97" (H) 215mm (L) x 152mm (W) x 50mm (H)
Weight	Approximately 2.77 lb (1.256 kg) with battery pack
Temperature	Operation: 32°F ~ 122°F (0°C ~ 50°C) Storage: -4°F ~ 158°F (-20°C ~ 70°C)
Humidity	5% ~ 95% RH non-condensing
Drop	Sustains a free drop of 1.2 meters onto a concrete floor
ESD protection	4KV DC contact, 8KV DC air

2.9 - Pin Assignments

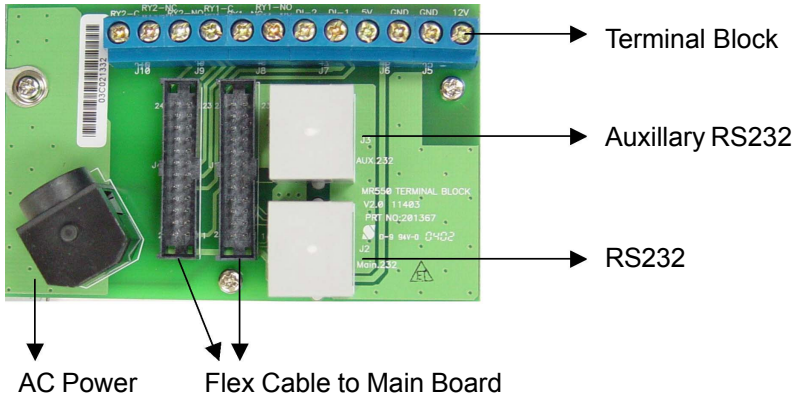

2.9.1 - AC Power Pin Assignments

Pin Number	Signal
1.	VAC Input 1
2.	VAC Input 2
3.	N/C

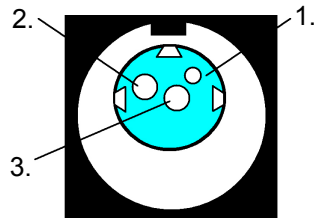

2.9.2 - RS232 Pin Assignments

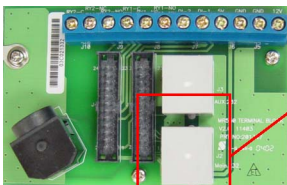

Pin	Signal	Description
1	DCD	Data Carrier Detected
2	RXD	Received Data
3	TXD	Transmitted Data
4	DTR	Data Terminal Ready
5	GND	Ground
6	DSR	Data Set Ready
7	RTS	Request To Send
8	CTS	Clear To Send

Chapter 2 - Specifications

2.9.3 - Auxillary RS232 Pin Assignments

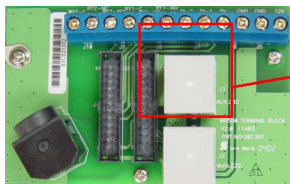

Pin	Signal	Description
1	-	Not Available
2	RXD	Received Data
3	TXD	Transmitted Data
4	-	Not Available
5	GND	Ground
6	-	Not Available
7	RTS	Request To Send
8	CTS	Clear To Send

2.9.4 - Terminal Block

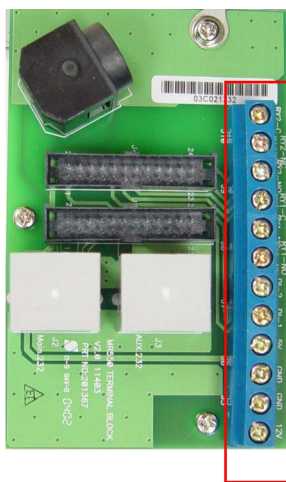

Pin	Function	Description
1	RY2-C	Common
2	RY2-NC	Normal Close
3	RY2-NO	Normal Open
4	RY1-C	Common
5	RY1-NC	Normal Close
6	RY1-NO	Normal Open
7	DI-1	Photo-In Cathode(-)
8	DI-2	Photo-Out Anode(+)
9	5V	Positive 5 Volts
10	5V	Ground
11	12V	Positive 12 Volts
12	5V	Ground

Chapter 3 - User Input

3.1 - Keypad

The MR550 keypad contains 6 rubber keys, including F1~F4, ESC, and ENTER key. Please refer to the picture below.

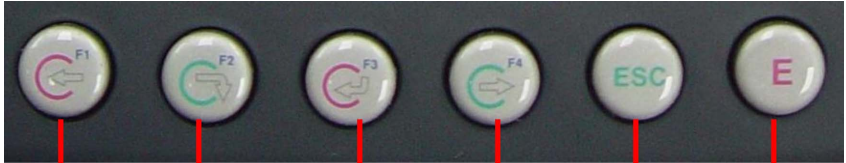

Clock-In
F1

Break-Out
F2

Break-In
F3

Clock-Out
F4

Escape

Enter

[F1]~[F4] Standard WinCE Function Keys

[ESC] The Escape key performs the same function as tapping the CANCEL or X icon on the touch screen

[BS] The Back-Space key is used to erase previously input characters

3.2 - Software Keyboard (WinCE Keyboard)

Because the MR550's rubber keypad allows input of numeric characters only, Windows CE Software provides a touch screen keyboard for input of other characters. The Windows-based keyboard replicates the layout of a standard PC keyboard.

3.2.1 - Open WinCE Keyboard:

Open the Windows CE keyboard by tapping the "keyboard" icon on the task bar. (Refer to the picture below).



Double-tap here

Chapter 3 - User Input

3.2.2 - Keying-in Characters:

After double tapping the “keyboard” icon, the Windows CE keyboard pops-up. Character input is the same as a standard PC. Simply tap the on-screen button corresponding to the character you want to input.

3.2.3 - International Character Support:

Tap the [áü] button to switch from the standard English keyboard to the European keyboard.

3.2.4 - Closing the Keyboard:

Double tap the keyboard icon to close Windows CE keyboard.

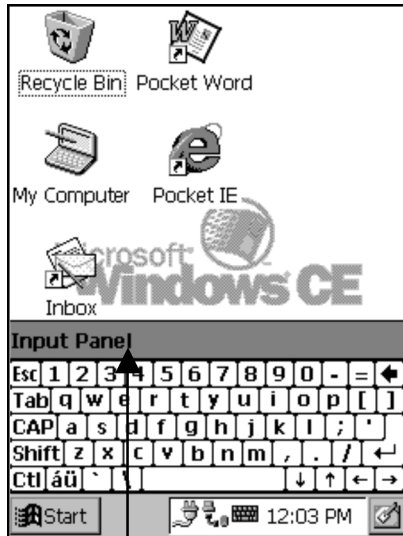

Title bar

3.3 - Using Proximity, MSR, or Barcode Reader

The MR550 has an integrated Proximity, MSR or Barcode reader, connected to Unitech’s new generation decoder chip, which can read all major barcode labels, magnetic stripe cards, or 125KHz EM proximity readers with excellent performance.

The MR550 also has a built-in TTY.EXE program that allows the user to test reader’s data. TTY.EXE is located in directory \WINDOWS, and is also accessible by short-cut via Programs located in the Start menu.



Chapter 4 - Useful Programs

4.1 - Bar2Key

In the MR550, the built-in scanner, magnetic stripe reader or proximity are connected to an advanced decoder chip, and this chip is connected to COM3 port. Application programs should call Unitech's scanner DLL library (Please refer to MR550 programming manual for detailed function of DLL library). Oftentimes it is not easy to get read data into application programs, especially if the application is provided by a third party, and users are not allowed to modify the source program.

“Bar2Key.exe” is an useful tool to get scanned/swiped data into any application program. While Bar2Key is running, all scanned/swiped data goes into the standard keyboard input buffer. Scanned/swiped data will be treated as normal keyboard input. Thus, any application program can input scanned/swiped data, just as if it were input by keyboard.

Bar2Key.EXE is located in the Windows folder. After executing the program, a Barcode icon will appear on the taskbar. Press scanner trigger key (or swipe) as you normally would to scan a barcode label.

For exiting Bar2Key, double tap the Barcode icon on the taskbar and then tap the Exit button.

For detail barcode symbology and MSR settings, please refer to the next 2 sections.

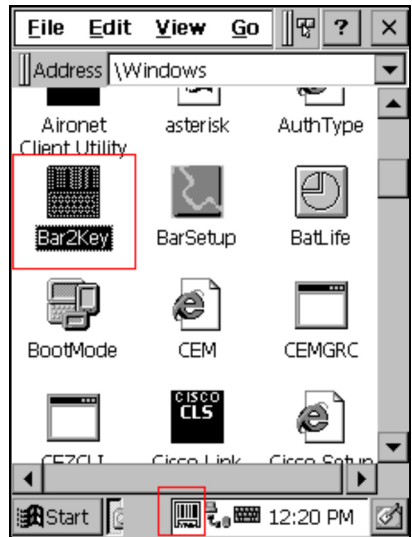

Chapter 4 - Useful Programs

4.2 - BarSetup

BarSetup provides the ability to change default symbologies for different applications, put delimiter characters behind scanning data, and save settings to individual profiles.

BarSetup can be found at **\\Windows\\BarSetup.exe**. After starting the program two buttons: **“Barcode Symbologies”** and **“Delimiter”** will be displayed.

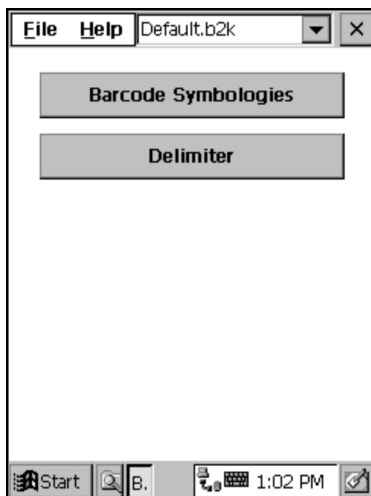

Customization symbologies for each symbology include:

Symbology	Enable/Disable	Send Check Digit	Maxi/Mini. Length	Send Leading Digit	Other
Code 39	Yes	Yes	Yes		Full ASCII Send Start/Stop character
I 2 of 5	Yes	Yes	Yes		Send Start/Stop character Fix length
S25/Toshiba	Yes	Yes	Yes		Fix length
Code 32	Yes				Send Leading code Send Tailing code
Telpen	Yes				Character Set
EAN128	Yes				
Code128	Yes		Yes		
MSI/Plessey	Yes	Yes	Yes		Check digit module
Code93	Yes		Yes		
Code11	Yes	Yes	Yes		One/Two check digit
Codabar	Yes	Yes	Yes		Send Start/Stop character CLSI format on
Label Code	Yes	Yes			
UPC-A	Yes	Yes		Yes	
UPC-E	Yes	Yes		Yes	Zero expansion on Enable NSC
EAN13	Yes	Yes		Yes	Enable Bookland
EAN8	Yes	Yes		Yes	
Supplement					Supplement 2 Supplement 5 Space separator inserted Transmit if present/ Must be present
Delta Code	Yes	Yes			Calculate Check digit

Delimiter: None, Tab, CR, LF, CRLF, Comma

Individual settings can be written to a file (*.b2k) and then dynamically loaded for different applications. Otherwise, the default settings can be used.

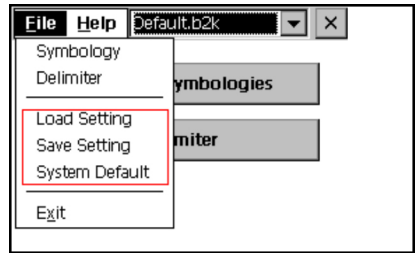

4.3 - MSR and Proximity Reader Setup

The MSR's track function and delimiter must be individually enabled/disabled for different applications.

MSRSetup provides the ability to change default settings, put delimiter characters behind track data, and either save settings to individual profiles or load profiles.

User can run this program from **Windows\MRRSetup.exe**. Displayed will be one button: "**MSR Delimiter**".

The Proximity reader is connected as an MSR track 2 reader by configuring it via the track 2 setting.

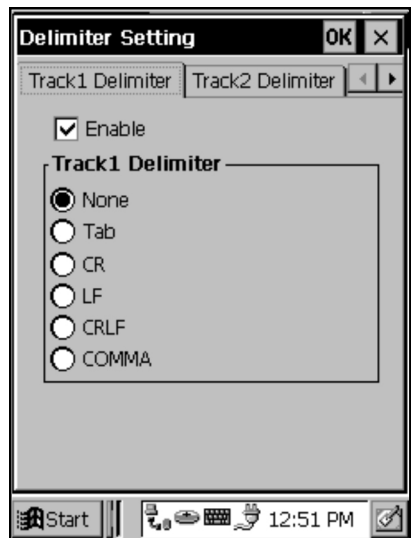

Chapter 4 - Useful Programs

4.3 - HockRS232 Event (Disable ActiveSync Driver for RS232 Port)

Normally, the MR550's RS232 port is set as the default communication port with the Host PC via ActiveSync. The MR550 will automatically activate the ActiveSync driver and try to connect to the Host PC if the user directly connects the RS232 cable without running any programs. Sometimes, however, the ActiveSync popup window becomes inconvenient.

"Hock RS232 Event.exe" is a useful tool to enable/disable ActiveSync driver. This program can be run from **Windows\HockRS232 Event.exe**. Pull down the "Edit" menu to select the proper item.

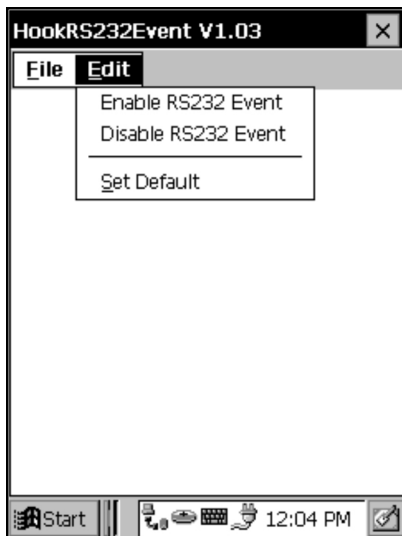

Warning

This is a FCC Part 15 Class B product and in a domestic environment this product may cause radio interference in which case the user may be required to take adequate measures.

Free Manuals Download Website

<http://myh66.com>

<http://usermanuals.us>

<http://www.somanuals.com>

<http://www.4manuals.cc>

<http://www.manual-lib.com>

<http://www.404manual.com>

<http://www.luxmanual.com>

<http://aubethermostatmanual.com>

Golf course search by state

<http://golfingnear.com>

Email search by domain

<http://emailbydomain.com>

Auto manuals search

<http://auto.somanuals.com>

TV manuals search

<http://tv.somanuals.com>