

IMPORTANT MANUAL

Do Not Throw Away

SEARS

**Operator's
Manual**



**Model No.
358.798380**

**CUSTOMER
ASSISTANCE
1-800-235-5878**

HOURS (CST)
Mon. - Sat. 7 a.m. - 7 p.m.
Sun. 10 a.m. - 7 p.m.



WARNING

**READ THE OPERATOR'S
MANUAL AND FOLLOW ALL
WARNINGS AND SAFETY
INSTRUCTIONS. FAILURE
TO DO SO CAN RESULT IN
SERIOUS INJURY.**

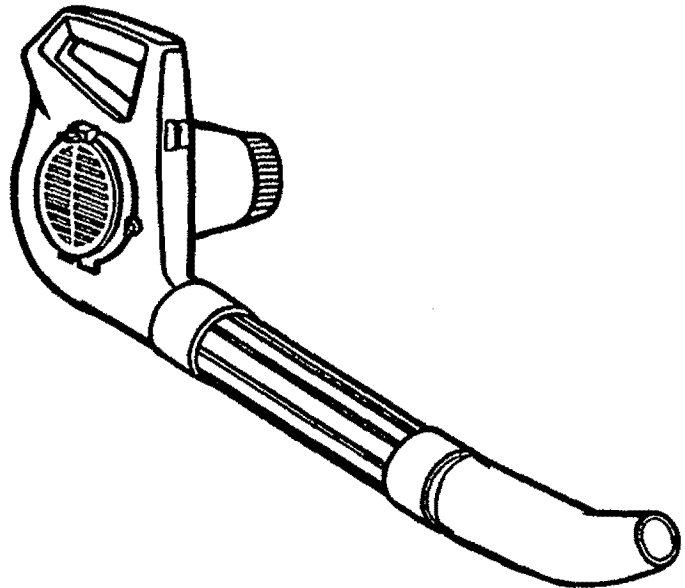

Always Wear Eye Protection

CRAFTSMAN[®]
12 AMP MOTOR
165 MPH Air Velocity
ELECTRIC BLOWER/VAC

DOUBLE INSULATED

- Assembly
- Operation
- Customer Responsibilities
- Storage

FOR HOUSEHOLD USE ONLY

Sears, Roebuck and Co., Hoffman Estates, IL 60179 USA

530-083224-09/29/94



IMPORTANT WARNINGS & SAFETY INSTRUCTIONS



WARNING

The warnings and safety instructions in this manual must be followed to reduce the risk of fire, electric shock, or injury, and to provide reasonable safety and efficiency in using this unit. The operator is responsible for following the warnings and instructions in this manual and on the unit. Read the entire Operator's Manual before assembling and using the unit! Restrict the use of this unit to persons who read, understand, and follow the warnings and instructions in this manual and on the unit.

OPERATOR SAFETY

- **Always wear safety glasses or similar eye protection** when operating, servicing, or performing maintenance on your unit. Wearing eye protection can help to prevent rocks or debris from being blown or ricocheting into eyes and face which can result in blindness or serious injury.
- **Always wear a respirator or facemask** when working with the unit in dusty environments.
- **Dress safely in long pants.** Do not go barefoot or wear short pants, sandals, jewelry, loose clothing, or clothing with loosely hanging straps, ties, tassels, etc.; they can be caught in moving parts. Secure hair so it is above shoulder length.
- **Do not operate the unit** when you are tired, ill, upset, or if you are under the influence of alcohol, drugs, or medication.
- **Keep loose hair, loose clothing, fingers, and all other parts of the body away from openings and moving parts.**
- **Keep children, bystanders, and animals away from the work area a minimum of 30 feet (10 meters) when starting or operating the unit.**
- **Inspect the area before using the unit.** Remove all debris and hard objects such as rocks, glass, wire, etc. that can ricochet, be thrown, or otherwise cause injury or damage during operation.
- **Restrict the use of this unit** to persons who read, understand, and follow the warnings and instructions in this manual and on the unit. Never allow children to use this unit.
- **When using the optional vacuum attachment kit,** the unit is designed to pick up dry material such as leaves, grass, small twigs, and bits of paper. Do not vacuum stones, gravel, metal, broken glass, etc., to avoid severe damage to the impeller. *To avoid the possibility of electrical shock, do not attempt to vacuum water or other liquids.*

ELECTRICAL SAFETY

- **Use only a voltage supply** as shown on the name plate of the unit.
- **Avoid dangerous situations.** Do not use in presence of flammable liquids or gases to avoid creating a fire or explosion and/or causing damage to unit.
- **WARNING—TO REDUCE THE RISK OF ELECTRICAL SHOCK—**Do not use in damp or wet locations or around swimming pools, hot tubs, etc. Do not expose to snow, rain, or water. Do not handle extension cord plug or unit with wet hands.
- **WARNING—**To reduce the risk of electrical shock, use extension cords specifically marked as suitable for

outdoor appliances having electrical rating not less than the rating of the unit. The cord must be marked with the suffix "W-A" (in Canada "W"). Use a polarized cord. Make sure your extension cord is in good condition. If damaged have the cord replaced. Keep cord from heat, oil, and sharp edges. An undersized extension cord will cause a drop in line voltage resulting in loss of power and overheating. If in doubt, use the next heavier gauge. The smaller the gauge number, the heavier the cord. (NOTE: Figure 7 shows the correct size to be used depending on the cord length).

- **Inspect the insulation and connectors** on the unit and extension cord before each use. If there is any damage, do not use until damage is repaired by a Sears Service Center.
- **Do not pull or carry by cord;** do not use cord as a handle, close a door on cord, or pull cord around sharp edges or corners. Keep cord away from heated surfaces. Do not unplug by pulling on cord. To unplug, grasp the plug, not the cord.
- **To reduce the possibility of the extension cord disconnecting from the unit** during operation, tie pig tail plug and cord receptacle together as shown in Figure 8.
- **Do not use the unit if the switch does not turn the unit on and off properly.** Have the unit repaired by a Sears Service Center.
- **Keep the extension cord clear of operator and obstacles at all times.** Do not expose cords to heat, oil, water, or sharp edges.
- **Avoid any body contact with any grounded conductor,** such as metal pipes or wire fences, to avoid the possibility of electric shock.
- **Do not use with damaged cord or plug.** If unit is not working as it should, has been dropped, damaged, left outdoors, or dropped into water, return it to a Sears Service Center.
- **Ground fault Circuit Interrupter (GFCI)** protection should be provided on the circuit or outlet to be used for this unit. Receptacles are available having built-in GFCI protection and may be used for this measure of safety.
- **To reduce the risk of electrical shock** this equipment has a polarized plug. This plug will fit in a polarized outlet or extension cord only one way. (One blade is wider than the other.) If the plug does not fit fully in the outlet, reverse the plug. If it still does not fit, contact a qualified electrician to install the proper outlet. Do not change the plug in any way.



LOOK FOR THIS SYMBOL TO POINT OUT IMPORTANT SAFETY PRECAUTIONS. IT MEANS — ATTENTION!!! BECOME ALERT!!! YOUR SAFETY IS INVOLVED.



IMPORTANT WARNINGS & SAFETY INSTRUCTIONS

UNIT SAFETY

- **Stop the motor and disconnect the power source** before opening the air inlet door or attempting to insert or remove the vacuum tubes. The motor must be stopped and the impeller blades no longer turning to avoid serious injury from the rotating blades.
- **Inspect the entire unit** before each use for worn, loose, missing, or damaged parts. Do not use until the unit is in proper working order.
- **Have all internal service** performed by qualified service repair personnel to avoid creating a hazard or voiding your warranty.
- **Have all maintenance** other than the recommended procedures described in the Operator's Manual performed by a Sears Service Center.
- **Always see a Sears Service Center to replace a damaged impeller.** Parts that are chipped, cracked, broken, or damaged in any other way can fly apart and cause serious injury. Replace damaged parts before using the unit.
- **Never run the unit without the proper equipment attached.** When used as a blower, always install a blower tube. When used as a vacuum, always install vacuum tubes and collection bag assembly.
- **Do not use** any accessory or attachment other than those recommended by the manufacturer for use with your unit.
- **Use only in daylight** or in good artificial light.

OPERATION SAFETY

- **Keep others including children, animals, bystanders, and helpers a minimum of 30 feet (10 meters) away.** Stop the motor immediately if you are approached.
- **Inspect the area before using the unit.** Remove all debris and hard objects such as rocks, glass, wire, etc. that can ricochet, be thrown, or otherwise cause injury or damage during operation.
- **When using the optional vacuum attachment kit,** the unit is designed to pick up dry material such as leaves, grass, small twigs, and bits of paper. Do not vacuum stones, gravel, metal, broken glass, etc. to avoid severe damage to the impeller. *Do not attempt to vacuum water or other liquids to avoid electrocution.*
- **Avoid accidental starting.** Be sure the switch is in the "off" position and keep your hand and fingers away from the switch while connecting the unit to the power source or when carrying a unit connected to the power source.
- **Turn off all controls and allow the motor to stop before disconnecting the unit from the power source.**
- **Disconnect the unit from the power source when not in use.** Do not leave the unit when it is plugged into an outlet.
- **Avoid dangerous environments.** Do not use in unventilated areas or where dust or explosive vapors can build up.
- **Do not set the unit on any surface** except a clean, hard area while the unit is running. Debris such as gravel, sand, dust, grass, etc. could be picked up by the air intake and thrown out through the discharge

If situations occur which are not covered in this manual, use care and good judgment. If you need assistance, contact your SEARS Service Center/Department or call the CUSTOMER ASSISTANCE HOTLINE at 1-800-235-5878.

- opening, damaging the unit, property, or causing serious injury to bystanders or operator.
- **Do not overreach or use from unstable surfaces** such as ladders, trees, steep slopes, rooftops, etc. Use extra care when cleaning on stairways. Keep firm footing and balance at all times.
- **Never place objects inside the blower tubes;** always direct the blowing debris away from people, animals, glass, and solid objects such as trees, automobiles, walls, etc. The force of air can cause rocks, dirt, or sticks to be thrown or to ricochet which can hurt people or animals, break glass, or cause other damage. Do not allow the unit to be used as a toy.
- **Never place any object in the air intake opening** as this could restrict proper air flow and cause damage to the unit.
- **Never run the unit without the proper equipment attached.** When used as a blower, always install a blower tube. When used as a vacuum, always install vacuum tubes and collection bag assembly. Make sure the collection bag assembly is completely zipped when unit is running to avoid flying debris.
- **Never use for spreading chemicals, fertilizers, or any other substances** which may contain toxic materials.
- **Avoid situations which could set the collection bag on fire.** Do not vacuum discarded matches, cigars, cigarettes, or ash from fireplaces, barbecue pits, brush piles, etc. To avoid spreading fire, do not use blower near leaf or brush fires, fireplaces, barbecue pits, ashtrays, etc.
- **Always use the collection bag shoulder strap** when vacuuming to avoid loss of control.
- **Use only for jobs explained in this manual.**

MAINTENANCE SAFETY

- **Maintain the unit according to recommended procedures.**
- **This unit is Double Insulated.** See the "DOUBLE INSULATION" section. **Have all service and maintenance not explained in your operator's manual performed by a Sears Service Center** to avoid creating a hazard and/or voiding your warranty.
- **Disconnect from power source before servicing,** cleaning, performing maintenance, or storing the unit.
- **Use only genuine replacement parts** as recommended by the manufacturer to avoid creating a hazard and/or voiding your warranty.
- **Never douse the unit with water** or other liquids or squirt with a water hose. Clean with a damp sponge and mild soap. See "STORAGE".
- **Check air intake openings, blower tubes, elbow tube, and vacuum tubes frequently,** always with the unit stopped and the power source disconnected. Keep vents and tubes free of debris which can accumulate and restrict proper air flow.
- **Do not attempt to repair unit.** Repairs must be performed by a Sears Service Center.
- **Do not burn, incinerate, or expose this unit to extreme heat.**
- **Store the unit unplugged in a high, cool, dry, indoors area out of the reach of children.**

SAVE THESE INSTRUCTIONS

CONGRATULATIONS on your purchase of a Sears Craftsman Electric Blower/vac. It has been designed, engineered and manufactured to give you the best possible dependability and performance.

Should you experience any problems you cannot easily remedy, please contact your nearest Sears Service Center/Department. Sears has competent, well trained technicians and the proper tools to service or repair this unit.

Please read and retain this manual. The instructions will enable you to assemble and maintain your unit properly. Always observe the "SAFETY RULES."

PRODUCT SPECIFICATIONS

VOLTAGE: 120 Volts A.C.
AMPS 12
AIR VOLUME 405 c.f.m.
AIR VELOCITY: 165 mph
WEIGHT 7 Pounds

MODEL NUMBER: **358.798380**

SERIAL NUMBER: _____

DATE OF PURCHASE: _____

THE MODEL AND SERIAL NUMBER WILL BE FOUND ON A DECAL ATTACHED TO THE PRODUCT.

YOU SHOULD RECORD BOTH SERIAL NUMBER AND DATE OF PURCHASE AND KEEP IN A SAFE PLACE FOR FUTURE REFERENCE.

MANUFACTURED UNDER THE FOLLOWING U.S. PATENT:
4,325,163.

CUSTOMER RESPONSIBILITIES

- Read and observe the safety rules.
- Follow a regular schedule in maintaining, caring for, and using your unit.
- Follow the instructions under "Customer Responsibilities" and "Storage" sections of this Operator's Manual.

FULL TWO YEAR WARRANTY ON SEARS BEST CRAFTSMAN ELECTRIC BLOWER/VAC

If this Craftsman Electric Blower/Vac fails to perform properly due to a defect in material or workmanship within two (2) years from the date of purchase, Sears will repair or replace it, free of charge.

This warranty does not cover the nylon line.

WARRANTY SERVICE IS AVAILABLE BY RETURNING THE CRAFTSMAN ELECTRIC BLOWER/VAC TO THE NEAREST SEARS SERVICE STORE IN THE UNITED STATES.

This warranty gives you specific legal rights, and you may also have other rights which vary from state to state.

SEARS, ROEBUCK AND CO., D/817WA, HOFFMAN ESTATES, IL 60179

TABLE OF CONTENTS

Safety Rules 2	Assembly 6
Product Specifications 4	Operation 9
Customer Responsibilities 4,12	Storage 13
Warranty 4	Trouble Shooting 13
Accessories 5	Repair Parts Ordering/Service Back Cover

INDEX

<p style="text-align: center;">A</p> <p>Accessories 5</p> <p>Assembly 6, 7,8</p> <p style="text-align: center;">C</p> <p>Customer Assistance Hotline Back Cover</p> <p>Customer Responsibilities 4, 12</p> <p style="text-align: center;">H</p> <p>Hardware Contents 6</p> <p style="text-align: center;">K</p> <p>Know Your Electric Blower/vac 9</p> <p style="text-align: center;">M</p> <p>Maintenance Schedule 12</p> <p>Model Number 4</p>	<p style="text-align: center;">O</p> <p>Operation 9, 10, 11</p> <p>Ordering Repair Parts Back Cover</p> <p style="text-align: center;">S</p> <p>Safety Rules 2,3</p> <p>Specifications 4</p> <p>Stopping & Starting your Unit 10</p> <p>Storage 13</p> <p style="text-align: center;">T</p> <p>Trouble Shooting 13</p> <p style="text-align: center;">W</p> <p>Warranty 4</p>
---	---

ACCESSORIES

These accessories and attachments were available when the unit was originally purchased. They are also available at most Sears retail outlets and service centers. Most Sears stores can order these items for you when you provide the model number of your unit.

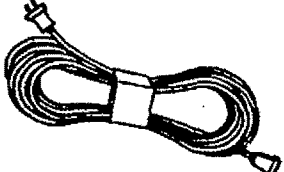
ACCESSORIES	
<p>Safety Goggles</p> 	<p>Extension Cord</p> 

HARDWARE CONTENTS

PARTS PACKED SEPARATELY IN CARTON NOT SHOWN ACTUAL SIZE

Operator's Manual

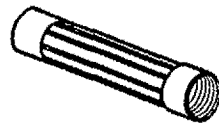

Blower Tube

Concentrator Nozzle

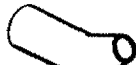

Flare Nozzle

Upper Vacuum Tube



Lower Vacuum Tube

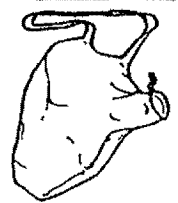

Collection Bag

ASSEMBLY

REMOVE BLOWER FROM CARTON

- Remove loose parts included with Blower/vac.
- Remove all packing material.
- Check carton thoroughly for additional loose parts.

ASSEMBLE YOUR UNIT INTO A BLOWER OR VACUUM MODE

You can assemble your unit as a blower or a vacuum. Later you can refer to these instructions and reconfigure your unit into a different mode. The instructions below provided information on how to assemble your unit for both configurations.

HOW TO ASSEMBLE YOUR UNIT AS A BLOWER

If your unit is configured in the vacuum mode, follow the following steps to prepare your blower for blower mode.

If your unit is not in the vacuum mode, continue with "ATTACHING THE BLOWER TUBE & NOZZLE."

- Stop the unit.
- Remove the vacuum tubes and collection bag.
- Latch the inlet cover closed, and replace the screw.

ATTACHING THE BLOWER TUBE & NOZZLE (Fig. 1, & 2)

Remove the blower vacuum tubes and collection bag, if assembled to the unit.

- Insert the blower tube into the blower outlet.
- Turn the blower tube clockwise until it is firmly seated in the blower outlet.
- With a slight twisting motion, slide nozzle firmly onto the end of the blower tube.

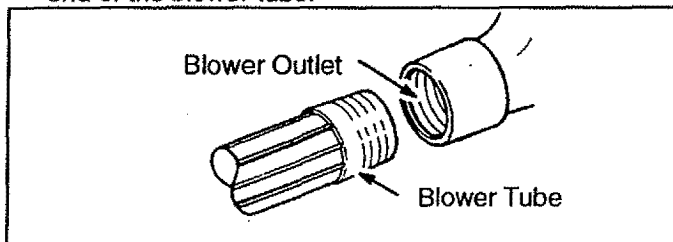

Figure 1

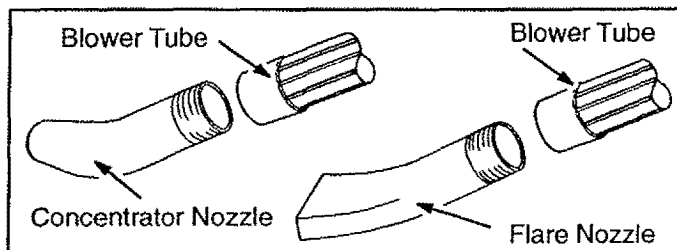

Figure 2

HOW TO ASSEMBLE YOUR UNIT AS A VACUUM

VACUUM TUBES ASSEMBLY (Fig. 3, & 4)



WARNING

STOP THE UNIT AND DISCONNECT IT FROM THE POWER SOURCE BEFORE OPENING THE INLET COVER OR ATTEMPTING TO INSERT OR REMOVE THE VACUUM TUBES. THE MOTOR MUST BE STOPPED AND THE IMPELLER BLADES NO LONGER TURNING TO AVOID SERIOUS INJURY FROM THE ROTATING BLADES.

The lower vacuum tube is cut at an angle. Make sure the label on the lower vacuum tube is aligned on the opposite side of the screw tab on the upper vacuum tube before pushing the two tubes together.

- Push the upper and lower vacuum tubes together.
- Using a Phillips screwdriver, remove the screw from the inlet cover.
- Press the locking latch and open the inlet cover.
- Holding inlet cover open, push assembled vacuum tubes into the opening until the locking latch engages.
- Reinstall screw.

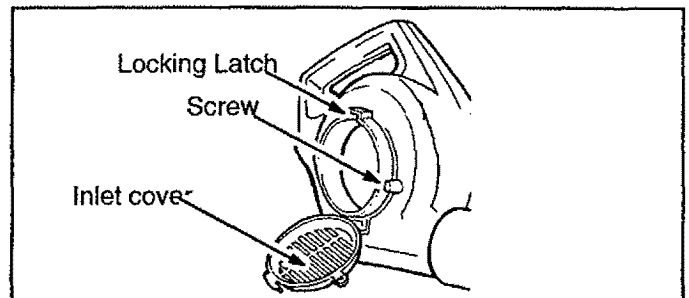

Figure 3

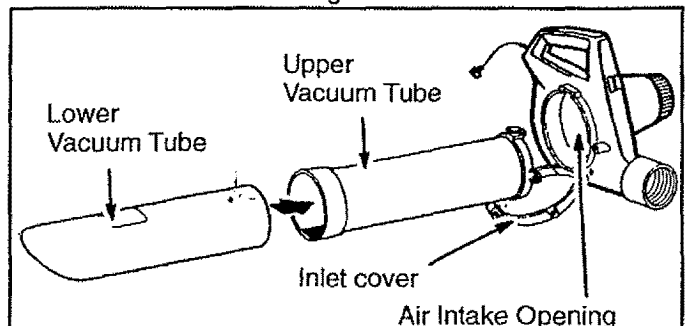

Figure 4

ASSEMBLY

ATTACHING COLLECTION BAG (Fig. 5)

- Slide the opening of the collection bag over the blower outlet. Pull the strap with Velcro tightly through the buckle and secure the Velcro tabs.

NOTE: Make sure the strap with Velcro is located between the motor housing and the collar on the blower outlet.

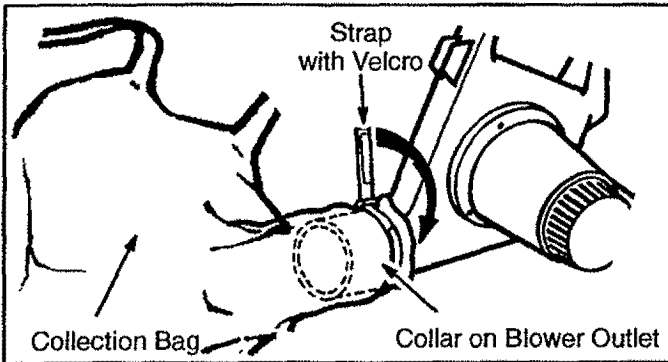

Figure 5

ADJUSTING THE SHOULDER STRAP ON THE COLLECTION BAG (Fig. 6, & 7)

- Carefully loop the shoulder strap through the buckle as shown in the illustration. Notice the first in and last in is the same hole.
- With your left hand hold the unit in an upright position. Support the lower vacuum tube on the ground. Make sure the blower outlet and collection bag are positioned on your right-hand side.
- Place the shoulder strap over your right shoulder.
- Adjust the shoulder strap to allow a free flow of air from the blower outlet. If the collection bag is kinked, the unit will not operate properly.

NOTE: The shoulder strap is designed to position the collection bag on your shoulder without kinks. The strap is not intended to support the weight of the unit.

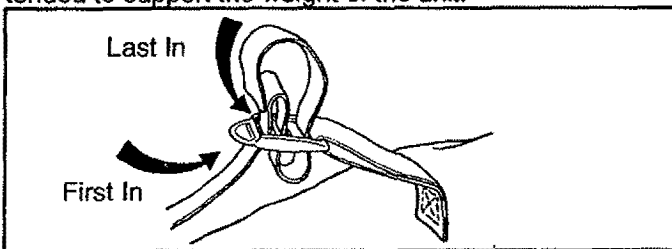

Figure 6



Figure 7

BLOWER CONVERSION

- Stop unit and disconnect from power source.
- Remove the vacuum tubes and collection bag.
- Secure the inlet cover making sure that the latch is securely fastened and screw is reinstalled.
- Reinstall the blower tubes. Refer to "Blower Tube Assembly" section.

EXTENSION CORD (Fig. 8, & 9)

Use only a voltage supply as shown on the nameplate of the unit to power your unit.

The extension cord used to reach the power source must be:

- Specifically marked as suitable for outdoor use.** The cord must be marked with the suffix "W-A." ("W" in Canada).
- Heavy enough to carry the current from the power source the full length of the extension cord to the unit.** Otherwise, loss of power and overheating can occur causing damage to the unit. Refer to Figure 8 for minimum wire gauge recommendations. The cord must be marked with the proper wire gauge.
- In good condition.** Cord insulation must be intact with no cracks or deterioration. Plug connectors must be undamaged.

Secure extension cord to unit as follows:

- Tie cord from unit to extension cord.
- Plug cord from unit into extension cord.

To reduce the risk of electric shock, this unit has a polarized plug (one blade is wider than the other). This plug will fit in a polarized extension cord only one way. If the plug does not fit fully into the extension cord, reverse the cord. If it still does not fit, make sure you have a polarized extension cord. If the extension cord does not fit into the outlet, reverse the cord. If it still does not fit into the outlet, contact a qualified electrician to install the proper outlet. Do not change the plug or socket of the unit or extension cord in any way.

MINIMUM WIRE GAUGE RECOMMENDATIONS				
VOLTS	25 FT.	50 FT.	100 FT.	150 FT.
120	16	16	14	12
	A.W.G.*	A.W.G.*	A.W.G.*	A.W.G.*

*American Wire Gauge

Figure 8

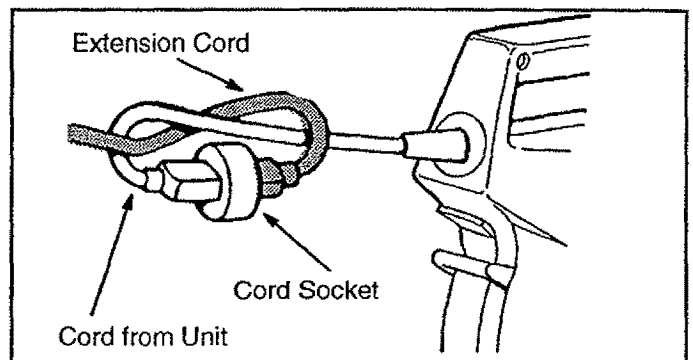

Figure 9

ASSEMBLY

CHECK LIST

- Check all fasteners. Make sure they are tight and there are no loose parts.
- Make sure the blower tube is firmly seated in the blower outlet.
- If you are using the unit as a blower, make sure the inlet cover is latched and the screw is fastened.
- In blower mode, check to insure the nozzle is securely seated in the blower tube.
- If you are using your unit as a vacuum, make sure the vacuum tubes are firmly connected, and positioned as shown in the assembly illustrations with the screw securely fastened.
- Make sure the collection bag is correctly adjusted with the shoulder strap on your left shoulder.
- Make sure your extension cord is marked with a suffix of "W-A". ("W" in Canada).

OPERATION

KNOW YOUR ELECTRIC BLOWER (Fig. 10)

READ THIS OPERATOR'S MANUAL AND SAFETY RULES BEFORE OPERATING YOUR ELECTRIC BLOWER. Compare the illustrations with your unit to familiarize yourself with the location of the various controls and adjustments. Save this manual for future reference.

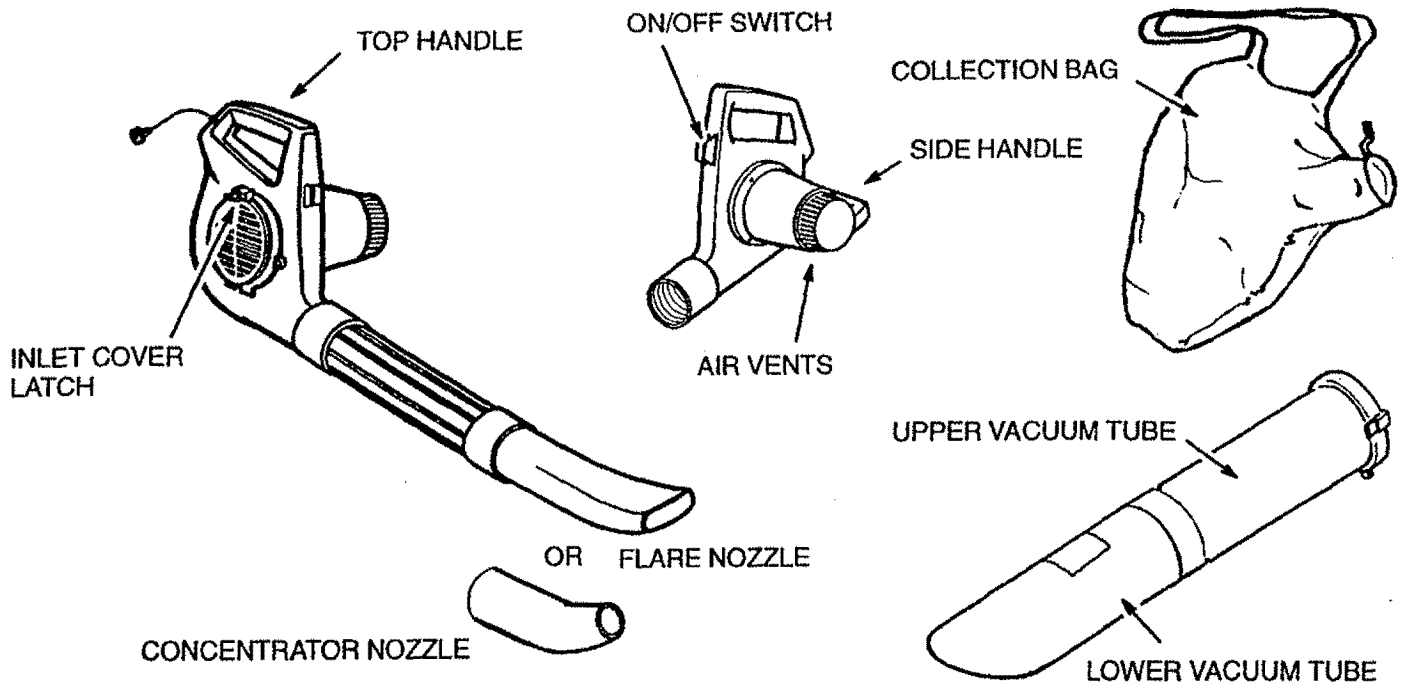

Figure 10

The ON/OFF SWITCH is used to turn on the unit.

The INLET COVER LATCH is used to open the inlet cover for attaching Upper Vacuum Tube.

The TOP HANDLE is used to hold the unit during the Blower and Vacuum mode.

The SIDE HANDLE is used to hold the unit during Vacuum mode.

The FLARE NOZZLE is used to direct the flow of air into a larger area than the CONCENTRATOR NOZZLE.

The CONCENTRATOR NOZZLE is used to direct the flow of air into a concentrated area.

DOUBLE INSULATION CONSTRUCTION



WARNING

ALL ELECTRICAL REPAIRS TO THIS UNIT, INCLUDING HOUSING, SWITCH, MOTOR, ETC., MUST BE DIAGNOSED AND REPAIRED BY QUALIFIED SERVICE PERSONNEL. REPLACEMENT PARTS FOR A DOUBLE INSULATED APPLIANCE MUST BE IDENTICAL TO THE PARTS THEY REPLACE. A DOUBLE INSULATED APPLIANCE IS MARKED WITH THE WORDS "DOUBLE INSULATION" OR "DOUBLE INSULATED". THE SYMBOL (SQUARE WITHIN A SQUARE)  MAY ALSO BE MARKED ON THE APPLIANCE. FAILURE TO HAVE THE UNIT REPAIRED BY QUALIFIED SERVICE PERSONNEL CAN CAUSE THE DOUBLE INSULATION CONSTRUCTION TO BECOME INEFFECTIVE AND RESULT IN SERIOUS INJURY.

This unit is Double Insulated to help protect against electric shock. Double insulation construction consists of two separate "layers" of electrical insulation instead of grounding.

Tools and appliances built with a double insulation system are not intended to be grounded. No grounding means is provided on this unit, nor should a means of grounding be added to this unit. As a result, the extension cord used with your unit can be plugged into any standard 120 volt electrical outlet.

Safety precautions must be observed when operating any electrical tool. The double insulation system only provides added protection against injury resulting from an internal electrical insulation failure.

OPERATION – SAFETY

OPERATOR SAFETY



WARNING

DO NOT ASSEMBLE OR DISASSEMBLE THE VACUUM TUBES WHILE THE UNIT IS RUNNING. INSERTING OR REMOVING THE VACUUM TUBES WHILE THE UNIT IS RUNNING CAN RESULT IN SERIOUS INJURY. ALWAYS STOP THE UNIT AND DISCONNECT THE POWER SOURCE BEFORE UNCLOGGING THE UNIT OR PERFORMING ANY MAINTENANCE ON THE COLLECTION BAG.

DO NOT USE THE UNIT WITHOUT THE BLOWER TUBES PROPERLY ATTACHED TO AVOID FLYING DEBRIS AND/OR IMPELLER CONTACT WHICH CAN CAUSE SERIOUS INJURY.

ALWAYS WEAR EYE PROTECTION TO PREVENT ROCKS OR DEBRIS FROM BEING BLOWN OR RICOCHETING INTO THE EYES AND FACE WHICH CAN RESULT IN BLINDNESS OR SERIOUS INJURY.

DO NOT USE THE UNIT AS A VACUUM WITHOUT THE VACUUM TUBES AND COLLECTION BAG PROPERLY ATTACHED TO AVOID FLYING DEBRIS AND/OR IMPELLER CONTACT WHICH CAN CAUSE SERIOUS INJURY. ALWAYS MAKE SURE THE COLLECTION BAG IS COMPLETELY ZIPPED BEFORE THE UNIT IS STARTED.

DO NOT ATTEMPT TO VACUUM WATER OR OTHER LIQUIDS TO AVOID ELECTROCUTION.

As a blower, the unit is designed to sweep debris, grass, straw, leaves, or small twigs. Never use for spreading or misting chemicals, fertilizers, or any other materials which may contain toxic substances. As a vacuum, the unit is designed to pick up dry material such as leaves, grass, small twigs, and bits of paper. Do not attempt to vacuum stones, gravel, metal, broken glass, or any other debris which may cause damage to the impeller. *Do not attempt to vacuum snow, water, or any other liquids:* vacuuming water or other liquids will cause damage to the unit. Avoid situations that could catch the collection bag on fire. Do not operate near an open flame. Do not vacuum discarded matches, cigars, or cigarettes, or ash from fireplaces, barbecue pits, brush piles, etc.

- **Read your Operator's Manual.** Make sure you completely understand and can follow all warnings and safety instructions in the manual *before* operating the unit.
- **Always wear eye protection** when operating, servicing, or performing maintenance to prevent rocks or debris from being blown or ricocheting into eyes and face which can result in blindness or other serious injury.
- **Always wear a respirator or face mask** when working in dusty environments.

- **Dress safely in long pants.** Do not go barefoot or wear short pants, sandals, jewelry, loose clothing, or clothing with loosely hanging straps, ties, tassels, etc.; they can be caught in moving parts. Secure hair so it is above shoulder length. Use of rubber gloves is recommended.
- **Check the unit before each operation.** Look for worn, loose, missing, or damaged parts. Do not use the unit until it is in proper working order.
- **Inspect area before operating unit.** Remove all debris and objects such as rocks, glass, wire, large sticks, etc. that can cause damage during operation.
- **Keep children, bystanders, and animals safely away.** *Before starting the unit and during operation, make certain children, people, and animals are a minimum of 30 feet away from the work area.*
- Check air intake opening, blower tubes, and vacuum tubes frequently, always with the motor stopped and the power source disconnected. Keep vents and discharge tubes free from debris which can accumulate and restrict proper air flow.
- Do not plug unit into any receptacle other than a normal 120 volt household outlet.
- Never immerse any part of the unit into any liquid.
- **Use the correct operating position.** Figure 11. Do not overreach or use from unstable surfaces such as ladders, trees, steep slopes, roof tops, etc. Keep firm footing and balance at all times.
- Never place objects inside the blower tubes; always direct blowing debris away from people, animals, glass, and solid objects such as trees, automobiles, walls, etc. The force of air can cause rocks, dirt, or sticks to be thrown or to ricochet which may hurt people or animals, break glass, or cause other damage.
- **When using your unit as a vacuum,** always use collection bag shoulder strap to avoid loss of control.
- **Never run the unit without the proper equipment attached.** When using your unit as a blower, always install blower tubes. When using your unit with the optional vacuum attachment, always install vacuum tubes and collection bag assembly. Make sure collection bag assembly is completely zipped.
- **Adjust shoulder strap and waist belt** to fit securely before operation of unit.

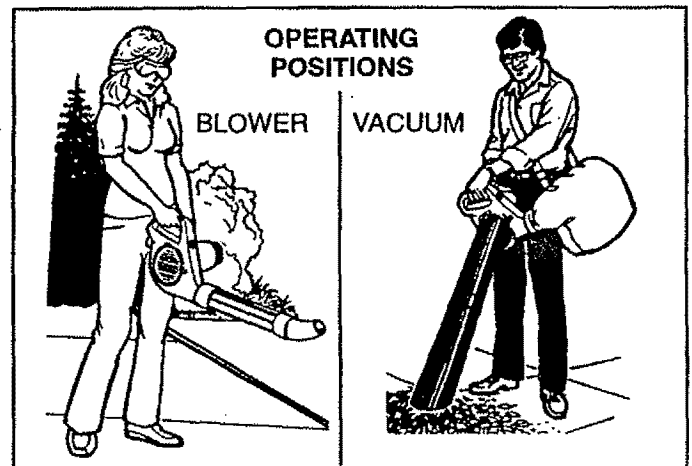

Figure 11

OPERATION

STOPPING YOUR UNIT

- Slide the switch to the OFF position.

STARTING YOUR UNIT

- Slide the switch to the LOW or HIGH position.

OPERATING YOUR UNIT



WARNING

DO NOT USE THE UNIT WITHOUT THE BLOWER TUBES PROPERLY ATTACHED TO AVOID FLYING DEBRIS AND/OR IMPELLER CONTACT WHICH CAN CAUSE SERIOUS INJURY.

ALWAYS WEAR EYE PROTECTION TO PREVENT ROCKS OR DEBRIS FROM BEING BLOWN OR RICOCHETING INTO THE EYES AND FACE WHICH CAN RESULT IN BLINDNESS OR SERIOUS INJURY.

USING YOUR UNIT AS A BLOWER (Fig. 11)

Use your unit as a blower for sweeping debris or grass clippings from driveways, sidewalks, patios, etc.

Use your unit as a blower for blowing grass clippings, straw, or leaves into piles, or removing debris from corners, around joints, and between bricks.

- Direct air flow by directing the nozzle down or to one side. Always work away from solid objects such as walks, large stones, automobiles, and fences.
- Clean corners by starting in corners and moving outward to straight areas to prevent an accumulation of debris which could fly into face.
- Be careful when working near plants. The force of the air could damage tender plants.

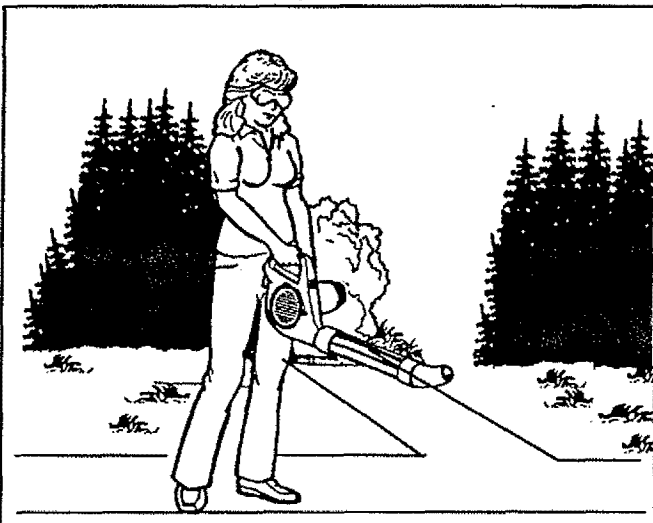

Figure 12

USING YOUR UNIT AS A VACUUM (Fig. 12)

Use your unit as a vacuum to pick up dry material such as leaves, grass, small twigs, and bits of paper.

- For best results operate your unit at high speed, while using as a vacuum.
- Move the unit slowly back and forth over debris to be vacuumed. Avoid forcing the vacuum tubes into a pile of debris as this can clog the unit.
- Keep the vacuum tube about an inch above the ground.

NOTE: If the unit becomes clogged:

- Stop the unit and disconnect the power source.
- Wait until the impeller has completely stopped turning, then remove the vacuum tubes.
- Carefully reach into the vacuum opening and clear out debris.

IMPORTANT: THE COLLECTION BAG MUST BE PROPERLY EMPTIED.

- You must properly empty and maintain the collection bag to avoid deterioration and obstruction of air flow.
- Remove the collection bag from the unit and empty after each use. Do not store collection bag containing leaves, grass, etc.
- Wash the collection bag once a year. Remove the bag from the blower and turn the bag inside out. Wash the bag with a water hose. Allow the bag to hang and dry before you reuse the bag.

Vacuum Operating Position

DO NOT FORCE INTO PILE.
DO MOVE VACUUM SLOWLY
BACK AND FORTH.

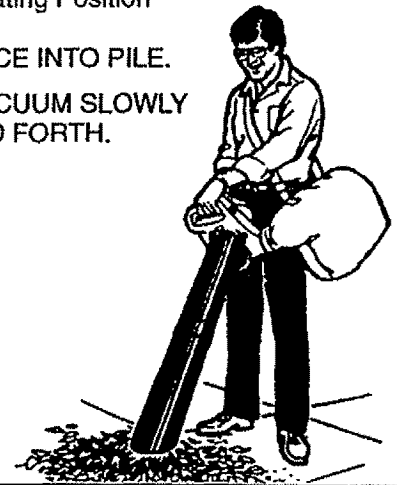

Figure 13

CUSTOMER RESPONSIBILITIES

MAINTENANCE SCHEDULE

Fill in dates as you complete regular service.	Before Use	After Use	Yearly	Service Dates		
Check for damaged or worn parts.	✓					
Clean unit and labels.	✓					
Check for loose fasteners and parts.		✓				
Wash collection bag.			✓			

GENERAL RECOMMENDATIONS

The warranty on this unit does not cover items that have been subjected to operator abuse or negligence. To receive full value from the warranty, the operator must maintain unit as instructed in this manual.

Some adjustments will need to be made periodically to properly maintain your unit.

All adjustments in the "Service and Adjustments" section of this manual should be checked at least once each season.

Follow the maintenance schedule in this manual.



WARNING

THIS BLOWER IS PROVIDED WITH DOUBLE INSULATION. USE ONLY IDENTICAL REPLACEMENT PARTS. ALL ELECTRICAL REPAIRS TO THE UNIT, INCLUDING ON/OFF SWITCH, MOTOR, ETC., MUST BE DIAGNOSED AND REPAIRED BY YOUR SEARS SERVICE CENTER. FAILURE TO DO SO CAN CAUSE THE DOUBLE INSULATION CONSTRUCTION TO BECOME INEFFECTIVE AND RESULT IN SERIOUS INJURY TO THE OPERATOR.

CLEAN UNIT AND LABELS

- Clean the unit using a damp cloth with a mild detergent.
- Wipe off the unit with a clean dry cloth.
- Keep air vents and air intake free from debris at all times.

BEFORE EACH USE

CHECK FOR DAMAGED/WORN PARTS

- Replace blower nozzles that are bent, warped, cracked, or damaged in any way.
- Replace vacuum tubes that are bent, warped, cracked, or damaged in any way.
- Inspect impeller for cracks.

CHECK FOR LOOSE FASTENERS/PARTS

- Inspect blower tube. Make sure tube is secure to the blower outlet.

HOW TO REMOVE AN OBJECT FROM THE AIR INTAKE (Fig. 14)

If an object is drawn into the unit through the air intake, do the following:

- Push the switch to the OFF position and disconnect cord from the power source.
- Remove the vacuum tubes.
- Locate and remove the object(s).
- Inspect the impeller for cracks. If cracked or damaged, DO NOT use the unit. Have impeller replaced by your Sears Service Center. DO NOT attempt to replace it yourself.

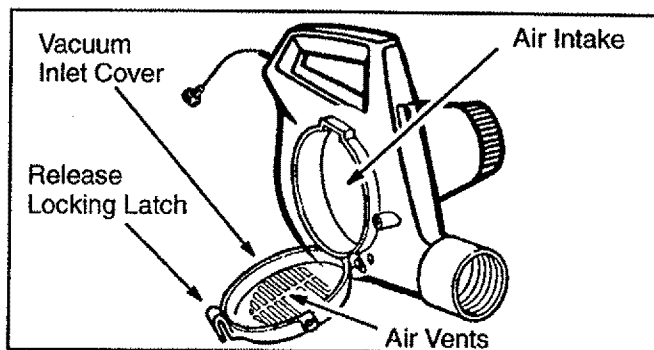

Figure 14

CLEANING THE COLLECTION BAG

The collection bag must be properly emptied and maintained to avoid deterioration and obstruction of air flow which will reduce the performance of your unit.

- Remove the bag and empty after each use. DO NOT store the bag leaves, grass, or debris.
- Wash the bag once a year by turning inside out and washing with a water hose. Be sure to let bag dry completely before re-using the unit.

STORAGE

Immediately prepare your unit for storage at the end of the season.

STORAGE INSTRUCTIONS

If our blower is to be stored for a period of time, clean it thoroughly before storage. Remove any dirt, leaves, debris, etc. Store in a clean dry area.

- Disconnect from the power source.
- Clean the entire unit.
- Open Inlet cover and clean any dirt, grass, or debris that has collected. Inspect the blower and vacuum tubes. Close and replace screw.

- Clean air vents and air inlet of debris.
- Reassemble all loose parts, being sure that all handles are in place and are securely fastened. Replace any damaged parts.
- Store your unit in a well ventilated area and covered, if possible, to prevent dust and dirt accumulation. Do not cover with plastic. Plastic cannot breathe and will induce condensation and eventual rust or corrosion.

TROUBLESHOOTING POINTS

TROUBLESHOOTING CHART

SYMPTOM	CAUSE	REMEDY
Unit fails to operate.	A. Switch in the OFF position. B. Disconnected from power source. C. Circuit breaker tripped, or fuse blown. D. Mechanical failure.	A. Push switch to the ON position. B. Reconnect unit to power source. C. Reset circuit breaker, or replace fuse. D. Contact your Sears Service/Dept.
Unit vibrates abnormally.	A. Mechanical failure.	A. Contact your Sears Service/Dept.
Impeller will not turn freely.	A. Debris in air intake area. B. Mechanical failure.	A. Clean unit. Remove any debris. B. Contact your Sears Service/Dept.

*If situations occur which are not covered in this manual, use care and good judgement.
If you need assistance, contact your Sears Service Center/Department or the
CUSTOMER ASSISTANCE HOTLINE at 1-800-235-5878*

SEARS

**Operator's
Manual**

**Model No.
358.798380**

**IF YOU NEED REPAIR
SERVICE OR PARTS:**

**REPAIR SERVICE
1-800-4-REPAIR
(1-800-473-7247)**

**ORDERING PARTS
1-800-FON-PART
(1-800-366-7278)**



**CUSTOMER
ASSISTANCE
1-800-235-5878**

**HOURS (CST)
Mon. - Sat. 7 a.m. - 7 p.m.
Sun. 10 a.m. - 7 p.m.**

CRAFTSMAN®

12 AMP MOTOR 165 MPH Air Velocity ELECTRIC BLOWER/VAC

Each Electric Blower/Vac has its own model number. The model number for your unit will be found on a decal attached to the unit. All parts listed herein may be ordered through Sears, Roebuck and Co. Service Centers and most Retail Stores.

**WHEN ORDERING REPAIR PARTS, ALWAYS GIVE THE
FOLLOWING INFORMATION**

- PRODUCT - "ELECTRIC BLOWER/VAC"
- MODEL NUMBER - 358.798380
- PART NUMBER
- PART DESCRIPTION

Your Sears merchandise has added value when you consider that Sears has service units nationwide staffed with Sears trained technicians... professional technicians specifically trained on Sears products, having the parts, tools and the equipment to insure that we meet our pledge to you, we service what we sell.

Sears, Roebuck and Co., Hoffman Estates, IL 60179 USA

Free Manuals Download Website

<http://myh66.com>

<http://usermanuals.us>

<http://www.somanuals.com>

<http://www.4manuals.cc>

<http://www.manual-lib.com>

<http://www.404manual.com>

<http://www.luxmanual.com>

<http://aubethermostatmanual.com>

Golf course search by state

<http://golfingnear.com>

Email search by domain

<http://emailbydomain.com>

Auto manuals search

<http://auto.somanuals.com>

TV manuals search

<http://tv.somanuals.com>