

3CCD CAMERA

# IK-TF1

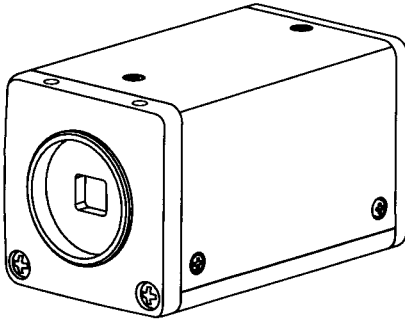

### For Customer Use

Enter below the Serial No. which is located on the bottom of the cabinet. Retain this information for future reference.

Model No.: IK-TF1

Serial No.: \_\_\_\_\_

### WARNING

This is a Class A of EN55022 product. In a domestic environment this product may cause radio interference in which case the user may be required to take adequate measures.

### INFORMATION

This equipment has been tested and found to comply with the limits for a Class A digital device, pursuant to Part 15 of the FCC Rules. These limits are designed to provide reasonable protection against harmful interference when the equipment is operated in a commercial environment. This equipment generates, uses, and can radiate radio frequency energy and, if not installed and used in accordance with the instruction manual, may cause harmful interference to radio communications. Operation of this equipment in a residential area is likely to cause harmful interference in which case the user will be required to correct the interference at his own expense.

**USER-INSTALLER CAUTION:** Your authority to operate this FCC verified equipment could be voided if you make changes or modifications not expressly approved by the party responsible for compliance to Part 15 of the FCC Rules.



This Class A digital apparatus complies with Canadian ICES-003.

Cet appareil numérique de la classe A est conforme à la norme NMB-003 du Canada.

# SAFETY PRECAUTIONS

Read the following safety precautions carefully before using the product. These instructions contain valuable information on safe and proper use that will prevent harm and damage to the operator and other persons. Make sure that you fully understand the following details (indications, graphic symbols) before proceeding to the main descriptions in this manual.



## Indication definitions

Indication	Meaning
 Warning	This indicates that ignoring this label and/or misoperation of the product may cause serious personal injury or even death.
 Caution	This indicates that ignoring this label and/or misoperation of the product may cause personal injury <sup>1</sup> and/or material damage <sup>2</sup> .

<sup>1</sup>: Bodily injury means injuries, burns and electric shock which does not require hospitalization or prolonged treatment.

<sup>2</sup>: Physical damage means extended harm to home, household effects.

## Graphic symbol definitions

Symbol	Meaning
	Indicates a prohibited action that must not be carried out. The actual prohibited action is indicated in the symbol or nearby graphically or described in text.
	Indicates a mandatory action that must be carried out. The actual mandatory action is indicated in the symbol or nearby graphically or described in text.

## Warning

- **Do not use the product when abnormality occurs.**

 Use in the abnormal state such as smoke emitting from the product, burning smell, being damaged by drop, invasion of foreign objects inside the product, etc., may cause fire and/or electric shock. Always be sure to disconnect the power plug from the electrical outlet (socket) at once and contact your dealer.

- **Do not install the product where splashing of water may occur, such as outdoor, a bathroom, etc.**  
This may cause fire and/or electric shock.

- **Do not repair, disassemble and/or modify by yourself.**  
This may cause fire and/or electric shock. Always be sure to contact your dealer for internal repair, check and cleaning of the product.

- **Keep the rated voltage for the product.**  
The use of power supply voltage outside the rated voltage may cause fire and/or electrical shock. Please refer to "5.CONNECTIONS".

- **Do not put a vessel(s) filled with a liquid (flower vase, etc.).**  
If a liquid enters the product, a fire and/or electric shock may occur.

- **Do not put the product in an unstable, slanting and/or vibrating place.**  
Drop and/or fall of the product may cause injury.

- **Do not touch power or TV antenna cords during a thunderstorm.**  
This might cause electric shock.



- **Follow these cautions when installing.**

- Do not put the product on a flammable material such as carpet or blanket.
  - Do not put the product in a narrow space, since the heat generated by the product may cause fire.
  - Do not put a flammable material on the product.  
If you do not keep above, the heat generated by the product may cause fire.
- 



- **Do not put the product in direct sunshine and/or high temperature.**

The temperature rise inside the product may cause fire.

---



- **Do not put the product in a moist or dusty place such as a bathroom, a place close to a humidifier, etc.**

This may cause fire and/or electric shock.

---



- **Do not put the product in a moist, soot and/or dusty place such as a kitchen, etc.**

Do not put the product where soot and steam may occur, such as a kitchen, etc. , or in a dusty place. This may cause fire and/or electric shock.

---



- **Do not shoot the sun with the lens and do not put the lens in the place exposed to an intensive light, such as sunshine, etc.**

Focusing of the light may cause injury of eye and/or fire.

---



- **Do not put the product in your mouth and do not swallow it.**

This may cause suffocation and/or injury.

---



- **Ask your dealer to perform a periodical check and internal cleaning.**

Dust inside the product may cause fire and/or trouble. For check and cleaning cost, please consult your dealer.

---

1. CAUTIONS ON USE AND INSTALLATION .....	6
2. COMPONENTS.....	6
3. ITEMS CONTROLLED BY USING ON SCREEN DISPLAY .....	7
4. NAMES AND FUNCTIONS .....	8
5. CONNECTION .....	9
5.1 Standard Connection.....	9
5.2 Cautions on Connection.....	9
5.3 Connector Pin Assignments.....	9
6. OPERATION .....	10
6.1 White Balance.....	10
6.2 Gain.....	12
6.3 Shading Correction.....	12
7. MODE SETTING BY ON SCREEN DISPLAY .....	13
7.1 Using the Menus .....	13
7.2 Menus.....	14
(1) SHUTTER (Electronic shutter).....	14
(1.1) Changing each setting in MANUAL mode .....	14
(1.2) Changing each setting in SS(synchro. scan) mode.....	15
(1.3) Changing each setting in EXT TRIG mode.....	16
(1.3.1) Changing each setting in 1 PULSE SNR mode.....	16
(1.3.2) Changing each setting in 1 PULSE SR mode .....	17
(1.3.3) Changing each setting in 2 PULSE mode .....	18
(2) GAIN (Video gain).....	19
(2.1) Changing each setting in GAIN.....	19
(3) WHT BAL (White balance).....	20
(3.1) Changing each setting in AWB (Automatic White Balance)mode .....	20
(3.2) Changing each setting in MANUAL mode .....	20
(4) PROCESS .....	21
(4.1) Changing master pedestal .....	21
(4.2) Changing R pedestal .....	21
(4.3) Changing B pedestal.....	21
(4.4) Changing White clip.....	21
(4.5) Changing shading correction mode .....	21
(4.6) Changing manual shading correction .....	21
(5) SYNC.....	22
(5.1) Adjusting horizontal phase.....	22
(5.2) Changing RGB SYNC.....	22

(6) OPTION .....	22
(6.1) Changing RS232C communication baud rate.....	22
(7) Setting to factory setting status.....	23
7.3 External Sync .....	23
(1) External sync signal input conditions.....	23
(2) External sync frequency range .....	23
(3) Using the unit with external sync signal.....	23
(3.1) H (horizontal) phase adjustment .....	23
(4) Changing HD/VD input/output.....	24
7.4 Synchro. Scan Operation .....	24
(1) Setting by 1H.....	24
(2) Setting by the frame.....	24
7.5 EXT TRIG(External trigger) .....	25
(1) 1 PULSE SNR (1 Pulse Sync Non Reset) .....	25
(2) 1 PULSE SR (1 Pulse Sync Reset) .....	27
(3) 2 PULSE .....	28
8. BEFORE MAKING A SERVICE CALL .....	30
9. SPECIFICATIONS .....	30
10. EXTERNAL APPEARANCE DIAGRAM.....	31

## 1. CAUTIONS ON USE AND INSTALLATION

### ●Carefully handle the units.

Do not drop, or give a strong shock or vibration to the camera. This may cause problems. Treat the camera cables carefully to prevent cable problems, such as cable breakdown and loosened connections.

### ●Do not shoot intense light.

If there is an intense light at a location on the screen such as a spot light, a blooming and smearing may occur.

When intense light enters, vertical stripes may appear on the screen. This is not a malfunction. Ghosts may occur when there is an intense light near the object. In this case, change the shooting angle.

### ●Install the camera in a location free from noise.

If the camera or the cables are located near power utility lines or a TV, etc. undesirable noise may appear on the screen. In such a case, try to change the location of the camera or the cable wiring.

### ●Moire

When thin stripe patterns are shooted, stripe patterns that are not actually there (moire) may appears as interference stripes. This is not a malfunction.

### ●Operating ambient temperature and humidity.

Do not use the camera in places where temperature and humidity exceed the specifications. Picture quality will lower and internal parts may be damaged.

Be particularly careful when using in places exposed to direct sunlight. When shooting in hot places, depending on the conditions of the object and the camera (for example when the gain is increased), noise in the form of vertical strips or white dots may occur. This is not a malfunction.

### ●Handling of the protection cap.

Keep the protection cap away from children. Children may put them into mouth or swallow them accidentally. The protection cap protects the image sensing plane when the lens is removed from the camera, do not throw away.

### ●When not using the camera for a longtime.

Stop supplying power.

### ●When cleaning the camera

Always turn off the power and clean with a piece of dry cloth. If necessary, gently wipe with a cloth dampened with thinned detergent. Do not use benzine, alcohol, thinner, etc. If used, coating and printed letters may be discolored. When cleaning the lens, use a lens cleaning paper, etc.

## 2. COMPONENTS

(1) Camera Control Unit.....	1
(2) Accessories	
(a) Instruction manual.....	1

### 3. ITEMS CONTROLLED BY USING ON SCREEN DISPLAY

Item		Available selections	Preset value (Factory setting)	
Electronic shutter	MODE	MANUAL, SS, EXT TRIG	MANUAL	
	EXT TRIG	1PULSE SNR, 1PULSE SR, 2PULSE	1PULSE SNR	
	MANUAL speed	OFF, 1/100s, 1/250s, 1/500s, 1/1000s, 1/2000s, 1/4000s, 1/10000s, 1/25000s, 1/50000s	OFF	
	Syncro. scan.	FLD	1/525H~260/525H, OFF, 1FRM~255FRM	OFF
		FRM	1/525H~260/525H, OFF, 2FRM~256FRM	
	Storage mode	FLD, FRM	FLD	
	Trigger (1PULSE SNR/SR)			
	Trigger(2PULSE)			
1PULSE exposure time	0.02ms ~ 16ms	16ms		
Gain	MODE	MANUAL, OFF	OFF	
	MANUAL	-3dB ~ 18dB	0dB	
White balance	MODE	AWB, MANUAL	AWB	
	Color temperature	3200K, 5600K	3200K	
	MANUAL R GAIN	-100 ~ 0 ~ 100	0	
	MANUAL B GAIN	-100 ~ 0 ~ 100	0	
Process	Master pedestal	-64 ~ 0 ~ 64	0	
	R pedestal	-64 ~ 0 ~ 64	0	
	B pedestal	-64 ~ 0 ~ 64	0	
	White clip	-50 ~ 0 ~ 50	0	
	Shading correction mode	MANUAL, OFF	MANUAL	
	Manual shading correction	-128 ~ 0 ~ 127	0	
Sync	H phase adjustment	-100 ~ 0 ~ 100	0	
	RGB SYNC	G, ALL ON, ALL OFF	G	
Option	Baud rate	9600bps, 19200bps	9600bps	

## 4. NAMES AND FUNCTIONS

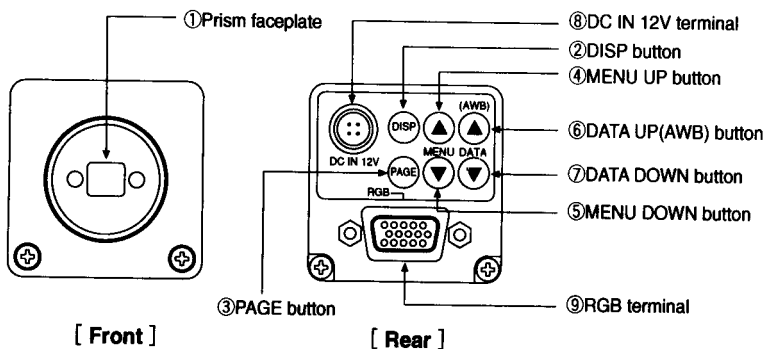

### ① Prism faceplate

The protection cap is attached on the lens mount portion. After removing the cap, mount the lens. Be careful not to scratch or touch the optical area.

### ② DISP button

Used when switching the display.

### ③ PAGE button

Used when switching to the menu and when selecting the menu.

### ④ MENU UP button

Select the function to be confirmed or changed on the menu.

### ⑤ MENU DOWN button

Select the function to be confirmed or changed on the menu.

### ⑥ DATA UP (AWB) button

Changes the value of the function selected by the MENU (UP/DOWN) button. (Also used when using AWB.)

### ⑦ DATA DOWN button

Changes the value of the function selected by the MENU (UP/DOWN) button.

### ⑧ DC IN 12V terminal

Accept a DC power input (12V).

### ⑨ RGB terminal

Used as the connector terminal for RGB output, and SYNC output.

HD and VD signals are input/output. When the random trigger operation is used, the trigger signal is input and the index signal is output. This terminal also includes an RS232C format control.



## 5. CONNECTION

### 5. 1 Standard Connection

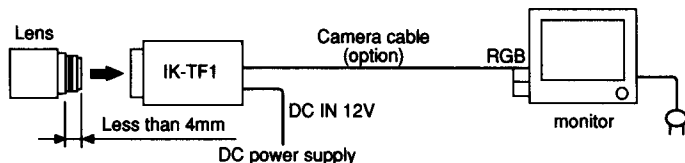

### 5. 2 Cautions on Connection

- When connecting the camera cables, be sure to turn off the camera and the other equipment connected.
- We suggest using a C mount lens made for a 3CCD camera.  
When using another lens, the best camera performance of this camera may not be obtained.  
(For example, low resolution may occur, focus may be lost through the range of a zoom lens, and flare, ghost or shading may occur)  
Furthermore, in order to avoid damaging the mounting portion of the camera head, use a lens which has projection dimension with the mounting base of less than 0.157"(4mm).
- For DC power supply connecting to DC IN 12V terminal, use UL listed and/or CSA approved ungrounding type AC adaptor with the specifications described below.

Power supply voltage	: DC12V ±10%
Current rating	: More than 830mA, Less than 2.5A
Ripple voltage	: Less than 50mV (p-p)
Connector	: HR10A-7P-4S by HIROSE electronics Co. Ltd
	Pins 1, 2 : 12V
	Pins 3, 4 : GND

### 5. 3 Connector Pin Assignments

#### DC IN 12V

1	+12V
2	+12V
3	GND
4	GND

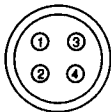

#### RGB

1	R
2	G
3	B
4	TXD
5	GND
6	GND
7	GND
8	SYNC
9	12V
10	GND
11	RXD
12	TRIG
13	HD IN/OUT
14	VD IN/OUT
15	INDEX

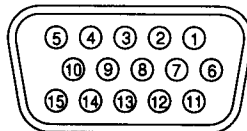

## 6. OPERATION

- ① Referring to the item " 5. CONNECTION", connect each equipment correctly.
- ② Turn on the connected equipment and the camera.
- ③ Pointing the lens at the object, operate the lens iris adjustment, focus adjustment, etc..
- ④ Referring to the item "6.1 White Balance", operate the adjustment.
- ⑤ Referring to the items "6.2 Gain, 7. MODE SETTING BY ON SCREEN DISPLAY", select the necessary items.

### 6. 1 White Balance

For the white balance adjustment for this unit, AWB (Automatic White Balance) and MANUAL (Manual white balance) adjustments are provided. Referring to the items "7.2 (3) WHT BAL (White balance), 7. MODE SETTING BY ON SCREEN DISPLAY", select the desired mode.

	<b>AWB</b> <b>(Automatic White Balance)</b>	<b>MANUAL</b> <b>(Manual White Balance)</b>
<b>Outline</b>	Adjust white balance by displaying the white object inside the area set by AWB menu and pressing the [DATA UP] button.	Adjust the white balance manually using the WHT BAL menu while shooting the white object.
<b>Notes</b>	When the shutter mode is EXT TRIG, AWB is not available.	Adjustment is performed by confirming with a waveform monitor.

#### ① AWB(Automatic white balance)

- Set the MODE to AWB on the WHT BAL menu.  
Perform the C.TEMP (color temperature conversion) setting, if necessary.  
(Refer to the item "7.2 (3) WHT BAL (White balance)".)
- 3200K : Appropriate for indoor shooting.
- 5600K : Appropriate for outdoor shooting.
- If the index menu/menu is displayed, press the [DISP] button to disable the color bar pattern or the character display on the menu.
- Shoot a known white object that fills the screen and push [DATA UP] button for approx. 1 second.
- The character AWB blinks on the screen when the AWB starts.
- The character AWB stops blinking when the AWB finishes, and the result is displayed for approx. 1 second.

Display	Meaning
<b>AWB OK</b>	Automatic white balance adjustment finished correctly.
<b>AWB NG LEVEL LOW</b>	Automatic white balance adjustment cannot be performed because the video level is too low. Set the video level properly.
<b>AWB NG LEVEL HIGH</b>	Automatic white balance adjustment cannot be performed because the video level is too high. Set the video level properly.
<b>AWB NG C. TEMP LOW</b>	Automatic white balance adjustment cannot be performed because the color temperature is too low. If the C.TEMP is set to 5600K, set to 3200K. If the message appears with the C.TEMP set to 3200K, change the illumination or use a color temperature conversion filter.
<b>AWB NG C. TEMP HIGH</b>	Automatic white balance adjustment cannot be performed because the color temperature is too high. If the C.TEMP is set to 3200K, set to 5600K. If the message appears with the C.TEMP set to 5600K, change the illumination or use the color temperature conversion filter.
<b>AWB NG NOT AVAILABLE</b>	Automatic white balance adjustment cannot be performed because the shutter speed mode is EXT TRIG mode.
<b>AWB NG</b>	Automatic white balance adjustment cannot be performed for other reasons. Such as no white area is included in an object, etc.

## ② MANUAL(Manual white balance)

- Set the MODE to MANUAL on the WHT BAL menu.  
(Refer to the item "7.2 (3) WHT BAL (white balance)".)
- Shoot a known white object, adjust the white balance adjusting the levels of R GAIN and B GAIN on the menu, confirming with a monitor or a waveform monitor.  
(Refer to the item "7.2 (3) (3.2) Changing each setting in MANUAL mode".)

## 6. 2 Gain

When the image is dark even if the lens iris is open, change the gain (video gain) to get the proper video level.

For the gain adjustment of the unit, MANUAL (Manual) and OFF (0 dB) modes are provided. Select the mode on the GAIN menu. (Refer to the item "7.2 (2) GAIN (Video gain)".)

### ① MANUAL(Manual gain)

Gain adjustment is performed on the GAIN menu. The adjustment range is from -3dB to 18dB in 1dB steps. (Refer to the item "7.2 (2) (2.1) (a) Changing the gain in MANUAL mode".)

### ② OFF

Gain is fixed at 0 dB.

## 6. 3 Shading Correction

Due to the lens used or the environmental condition, vertical color shading may occur at the top and bottom of the screen. In this case, the shading correction can decrease the color shading. For the shading correction of the unit, MANUAL (Manual shading correction) and OFF (no shading correction) modes are provided. Select the mode on the PROCESS menu. (Refer to the item "7.2 (4) (4.5) Changing shading correction mode".)

### ① MANUAL(Manual Shading)

Perform the correction amount setting on the PROCESS menu, confirming with a monitor or a waveform monitor. (Refer to the "7.2 (4) (4.6) Changing the manual shading correction setting".)

### ② OFF

The status is no shading correction.

**\* The shading correction is effective when the lens iris or zoom ratio is fixed. Use the unit with SHADING OFF for variable lens conditions.**

## 7. MODE SETTING BY ON SCREEN DISPLAY

Various settings can be controlled on the unit by using the on screen menu displayed on the monitor. The contents once set are memorized when the power is turned off, so it is unnecessary to set again when using the unit next time. When the setting is performed, select the menu of the item to be set.

### 7. 1 Using the Menus

When the power turns on, the normal screen showing only the video signal appears. Change the output to each screen (video signal output, Index menu, and menus) by using the [DISP], [PAGE], [MENU UP], and [MENU DOWN] buttons.

\* A menu is selected when pushing the [PAGE] button after moving the "→" on the screen by the [MENU UP], [MENU DOWN] button while the Index menu is displayed.

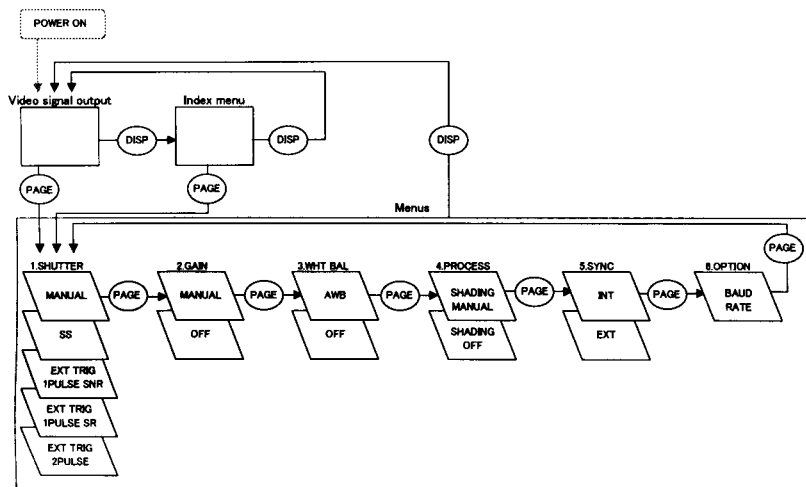

## 7. 2 Menus

- Select the menu to change the setting by referring the item "7.1 Using the Menus".)
- When the [MENU UP], [MENU DOWN] buttons are pushed, the "→" on the screen moves up and down. Move the "→" to the item to change.

### (1) SHUTTER(Electronic shutter)

The electronic shutter has three modes; MANUAL, SS(Synchro. Scan), EXT TRIG(External trigger).

Press the "Page" button to enter the Shutter Page. Use the "Data Up/Down" buttons to select the Shutter Mode.

#### (1. 1) Changing each setting in MANU mode

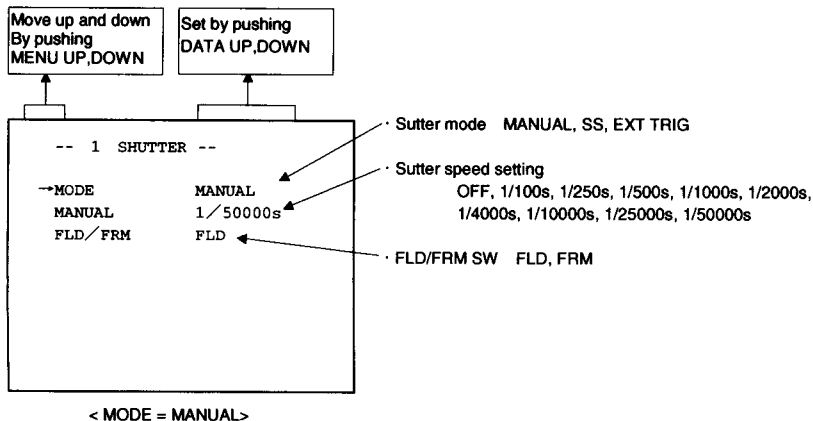

#### (a) Changing the shutter speed

- ① Set the "→" to MANU by pushing [MENU UP], [MENU DOWN] buttons.
- ② Set the shutter speed by pushing [DATA UP], [DATA DOWN] buttons.

#### (b) Changing the CCD storage mode

- ① Set the "→" to FLD/FRM by pushing [MENU UP], [MENU DOWN] buttons.
- ② Select either FLD (field) or FRM (frame) by pushing [DATA UP], [DATA DOWN] buttons.

## (1. 2) Changing each setting in SS(synchro. scan)mode

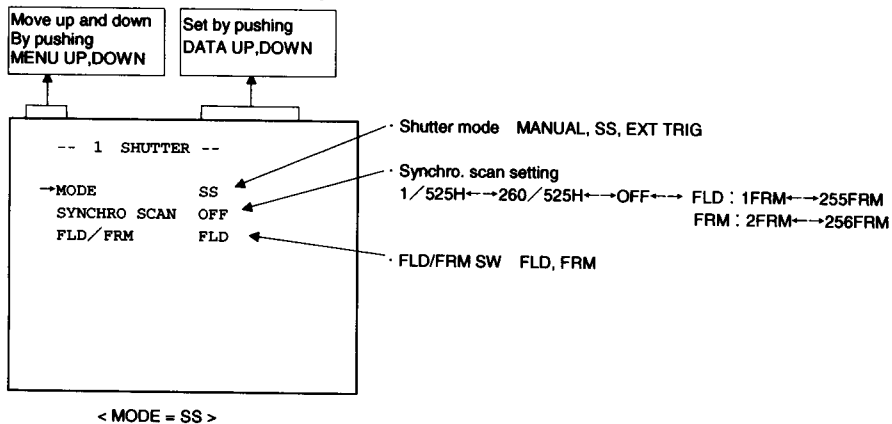

### (a) Changing the shutter speed setting

- ① Set the "→" to SYNCHRO SCAN by pushing [MENU UP], [MENU DOWN] buttons.
- ② Select the shutter speed by pushing [DATA UP], [DATA DOWN] buttons.

### (b) Changing the CCD storage mode

- ① Set the "→" to FLD/FRM by pushing [MENU UP], [MENU DOWN] buttons.
- ② Select either FLD (field) or FRM (frame) by pushing [DATA UP], [DATA DOWN] buttons.

### Note:

The longer the storage time with extended exposures, the more visible certain characteristics of CCD cameras become: fixed pattern noise, white pixels, etc.

### (1. 3) Changing each setting in EXT TRIG mode

The EXT TRIG has three modes; 1PULSE SNR, 1PULSE SR, 2PULSE.

First set the "→" to MODE and select EXT TRIG, then set the "→" to EXT TRIG and select the desired EXT TRIG mode.

#### (1. 3. 1) Changing each setting in 1PULSE SNR mode

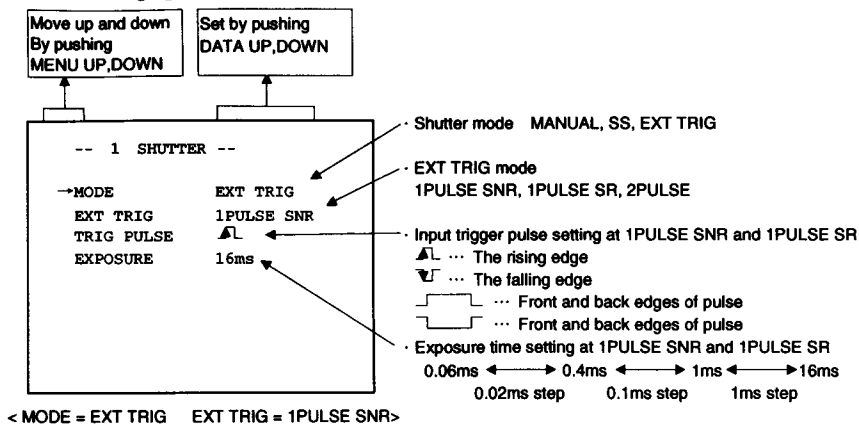

#### (a) Changing inputting trigger pulse setting

① Set the "→" to TRIG PULSE by pushing [MENU UP], [MENU DOWN] buttons.

② Select either , , , by pushing [DATA UP], [DATA DOWN] buttons.

\* This setting is only valid in the 1PULSE mode (1PULSE SNR and 1PULSE SR). To make the trigger pulse setting when using the 2PULSE mode, first set the EXT TRIG mode to 2PULSE, then make the settings with the TRIG PULSE items.

#### (b) Changing 1PULSE exposure time setting

① Set the "→" to EXPOSURE by pushing [MENU UP], [MENU DOWN] buttons.

② Set the exposure time by pushing [DATA UP], [DATA DOWN] buttons.

\* When or is selected, EXPOSURE cannot be set. (EXPOSURE setting turns OFF.)  
Exposure time is automatically controlled by the trigger pulse width.



### (1. 3. 2) Changing each setting in 1PULSE SR mode

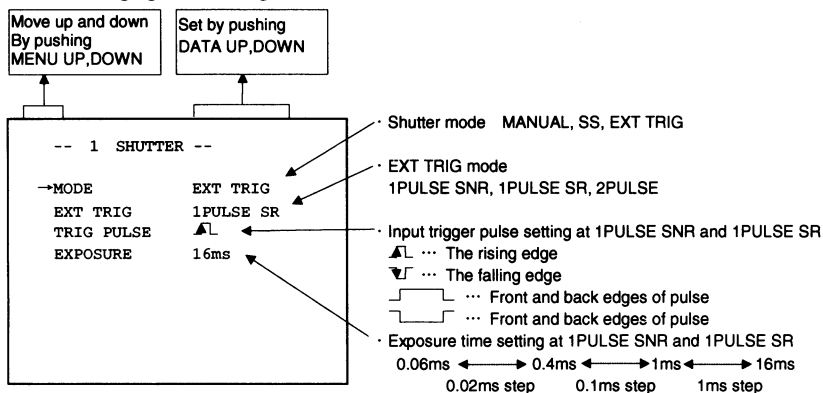

< MODE = EXT TRIG    EXT TRIG = 1PULSE SR >

#### (a) Changing inputting trigger pulse setting

① Set the "→" to TRIG PULSE by pushing [MENU UP], [MENU DOWN] buttons.

② Select either ▲L, ▼L, ┌───┐, └───┘ by pushing [DATA UP], [DATA DOWN] buttons.

\* This setting is only valid in the 1PULSE mode (1PULSE SNR and 1PULSE SR). To make the trigger pulse setting when using the 2PULSE mode, first set the EXT TRIG mode to 2PULSE, then make the settings with the TRIG PULSE items.

#### (b) Changing 1PULSE exposure time setting

① Set the "→" to EXPOSURE by pushing [MENU UP], [MENU DOWN] buttons.

② Set the exposure time by pushing [DATA UP], [DATA DOWN] buttons.

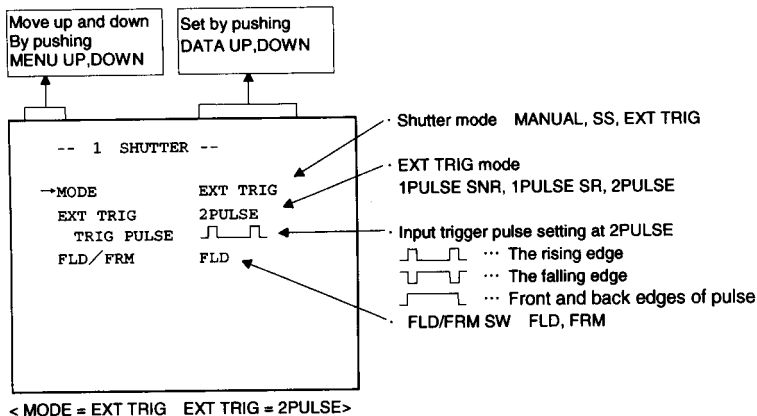

\* When ┌───┐ or └───┘ is selected, EXPOSURE cannot be set. (EXPOSURE setting turns OFF.)  
Exposure time is automatically controlled by the trigger pulse width.

### (1. 3. 3) Changing each setting in 2PULSE mode



#### (a) Changing inputting trigger pulse setting

① Set the "→" to TRIG PULSE by pushing [MENU UP], [MENU DOWN] buttons.

② Select either ,  or  by pushing [DATA UP], [DATA DOWN] buttons.

\* This setting is only valid in the 2PULSE mode. To make the trigger pulse setting when using the 1PULSE mode, first set the EXT TRIG mode to 1PULSE SNR or 1PULSE SR, then make the settings with the TRIG PULSE items.

#### (b) Changing the CCD storage mode

① Set the "→" to FLD/FRM by pushing [MENU UP], [MENU DOWN] buttons.

② Select either FLD (field) or FRM (frame) by pushing [DATA UP], [DATA DOWN] buttons.

## **(2) GAIN (Video gain)**

GAIN has two modes; MANUAL, OFF.

Set the "→" to MODE, push the [DATA UP], [DATA DOWN], and select mode among MANUAL, OFF. In the OFF mode, gain is fixed to 0dB.

### **(2. 1) Changing each setting in GAIN**

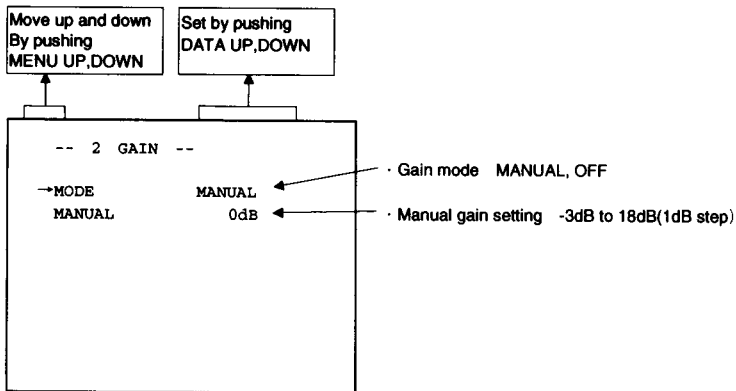

#### **(a) Changing the gain in MANUAL mode**

- ① Set the "→" to MANUAL by pushing [MENU UP], [MENU DOWN] buttons.
- ② Set the manual gain by pushing [DATA UP], [DATA DOWN] buttons.

### (3) WHT BAL(White balance)

WHT BAL has two modes; AWB, MANUAL.

Set the "→" to MODE, push the [DATA UP], [DATA DOWN], and select mode among AWB, MANUAL.

#### (3. 1) Changing each setting in AWB(Automatic White Balance) mode

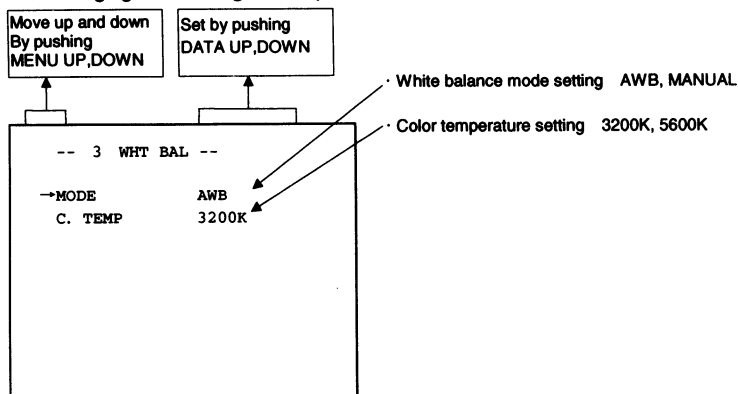

#### (a) Changing color temperature setting

- ① Set the "→" to C.TEMP by pushing [MENU UP], [MENU DOWN] buttons.
- ② Select either 3200K or 5600K by pushing [DATA UP], [DATA DOWN] buttons.

#### (3. 2) Changing each setting in MANUAL mode

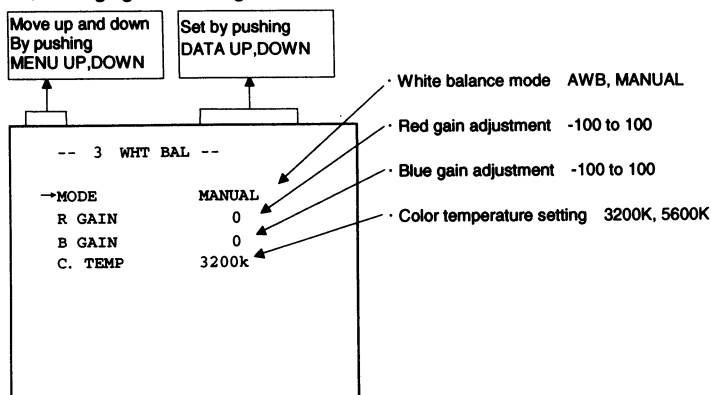

#### (a) Changing the red gain

- ① Set the "→" to R GAIN by pushing [MENU UP], [MENU DOWN] buttons.
- ② Set the red gain by pushing [DATA UP], [DATA DOWN] buttons.

#### (b) Changing the blue gain

- ① Set the "→" to B GAIN by pushing [MENU UP], [MENU DOWN] buttons.
- ② Set the blue gain by pushing [DATA UP], [DATA DOWN] buttons.

#### (4) PROCESS

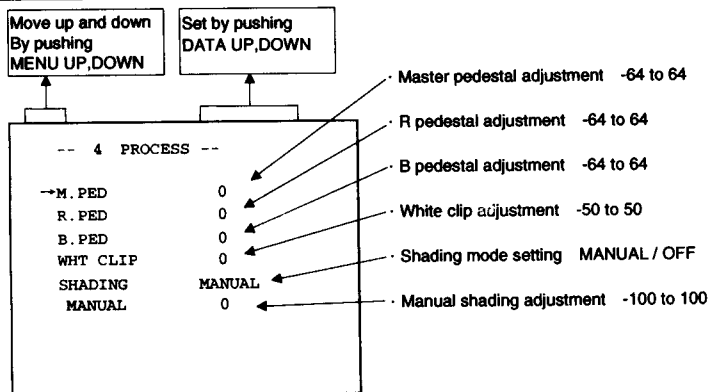

#### (4. 1) Changing master pedestal

- ① Set the "→" to M. PED by pushing [MENU UP], [MENU DOWN] buttons.
- ② Set the master pedestal by pushing [DATA UP], [DATA DOWN] buttons.

#### (4. 2) Changing R pedestal

- ① Set the "→" to R. PED by pushing [MENU UP], [MENU DOWN] buttons.
- ② Set the R pedestal by pushing [DATA UP], [DATA DOWN] buttons.

#### (4. 3) Changing B pedestal

- ① Set the "→" to B. PED by pushing [MENU UP], [MENU DOWN] buttons.
- ② Set the B pedestal by pushing [DATA UP], [DATA DOWN] buttons.

#### (4. 4) Changing White clip

- ① Set the "→" to WHT CLIP by pushing [MENU UP], [MENU DOWN] buttons.
- ② Set the WHT CLIP by pushing [DATA UP], [DATA DOWN] buttons.

#### (4. 5) Changing shading correction mode

- ① Set the "→" to SHADING by pushing [MENU UP], [MENU DOWN] buttons.
- ② Set the SHADING by pushing [DATA UP], [DATA DOWN] buttons.

#### (4. 6) Changing manual shading correction

- ① Set the "→" to MANUAL SHADING by pushing [MENU UP], [MENU DOWN] buttons.
- ② Set the MANUAL SHADING by pushing [DATA UP], [DATA DOWN] buttons.

## (5) SYNC

When an external sync signal is input, the display changes from INT (internal sync) to EXT (external sync) automatically.

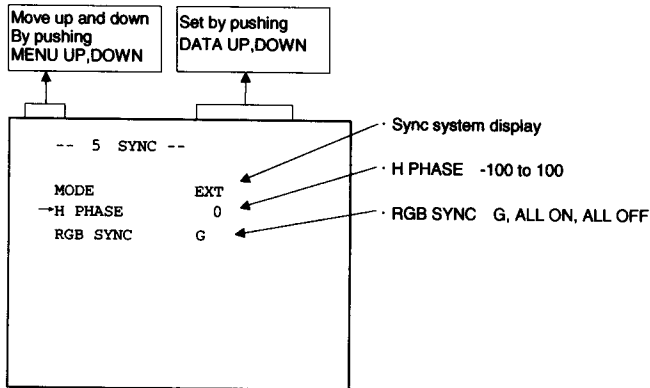

### (5. 1) Adjusting horizontal phase

- ① Set the "→" to H PHASE by pushing [MENU UP], [MENU DOWN] buttons.
- ② Adjust the horizontal phase by pushing [DATA UP], [DATA DOWN] buttons.

### (5. 2) Changing RGB SYNC

- ① Set the "→" to RGB SYNC by pushing [MENU UP], [MENU DOWN] buttons.
- ② Select G, ALL ON or ALL OFF by pushing [DATA UP], [DATA DOWN] buttons.

## (6) OPTION

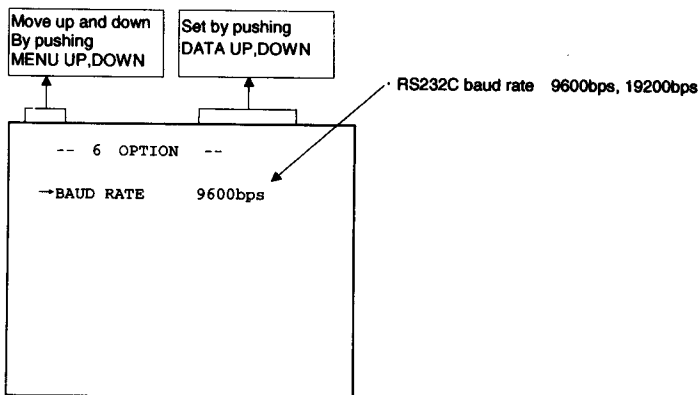

### (6. 1) Changing RS232C communication baud rate

- ① Set the "→" to BAUD RATE by pushing [MENU UP], [MENU DOWN] buttons.
- ② Select either 9600bps or 19200bps by pushing [DATA UP], [DATA DOWN] buttons.

## **(7) Setting to factory setting status**

The contents set of each scene file can be returned to the factory default status (preset status).

- (1) If characters are displayed on the screen, press the [DISP] button to disable the character display.
- (2) Push [MENU DOWN] and [DATA DOWN] buttons simultaneously for approx. 1 second.
- (3) The preset operation starts. When the preset operation finishes, the character PRESET OK is displayed for approx. 1 second.

## **7. 3 External Sync**

When using the unit with an external sync signal, input HD and VD to RGB terminal on the rear panel, or input SYNC to RGB terminal. When the external sync signal is input, the camera automatically switches its sync from the internal sync to the external sync.

The operation is as shown below, depending on the unit's status and how external sync signals are input.

Unit's status	HD / SYNC input	VD input	Operation
Shutter mode: EXT TRIG EXT TRIG: 1PULSE SR or 2PULSE	Off	—	Internal sync
	HD	—	External sync with HD (Only for H sync with HD)
	SYNC	—	External sync with SYNC (H sync with HSYNC)
Others	Off	Off	Internal sync
	HD	On	External sync with HD, VD (H-V sync with HD, VD)
	SYNC	Off	External sync with SYNC (H-V sync with H SYNC, V SYNC)
	Off	On	External sync with VD (Only for VD reset)
	SYNC	On	Prohibited

— : Don't care.

### **(1) External sync signal input conditions**

HD	: 2 to 5V (p-p)	Negative
VD	: 2 to 5V (p-p)	Negative

### **(2) External sync frequency range**

(External sync with HD, VD)

For EIA standard frequency : Within  $\pm 1\%$  (at horizontal sync frequency)

### **(3) Using the unit with external sync signal**

When adjusting H (horizontal) phase refer to the item "7.2 (5)(5.1) Adjusting horizontal phase".

#### **(3. 1) H (horizontal) phase adjustment**

Observe the external sync signal and the video signal output waveform of the unit with a dual trace oscilloscope, and adjust H phase so that the H phases match.

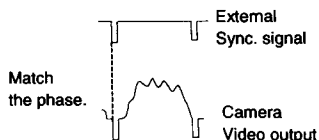

#### (4) Changing HD/VD input/output

- (1) Put off 6 screws both on flank/top of camera chassis.
- (2) Change internal switch SJ01(HD/VD).

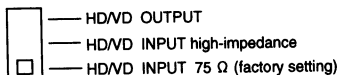
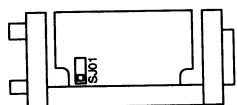

### 7. 4 Synchro. Scan Operation

The shutter speed can be set by the horizontal scanning period (1H) or by the frame. Also, CCD integration mode can be set.

#### (1) Setting by 1H

260/525H to 1/525H stands for the setting by the 1H and the shutter speed can be set by the 1H (63.56ms).

#### (2) Setting by the frame

1FRM to 255FRM (at field storage) and 2FRM to 256FRM (at frame storage) stand for the setting (long period exposure) by the frame.

##### (a) Field storage period

The video signal stored during the frame period set is output as 1 field video image at a frame interval specified.

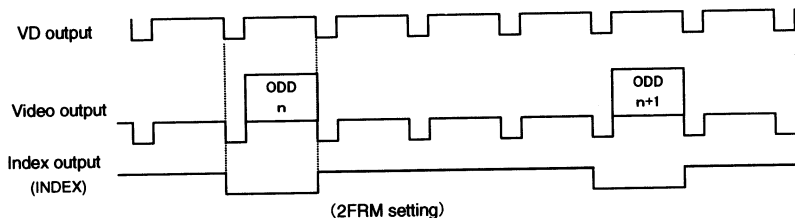

##### (b) Frame storage period

The video signal stored during the frame period set is output as 1 frame video image in a frame interval.

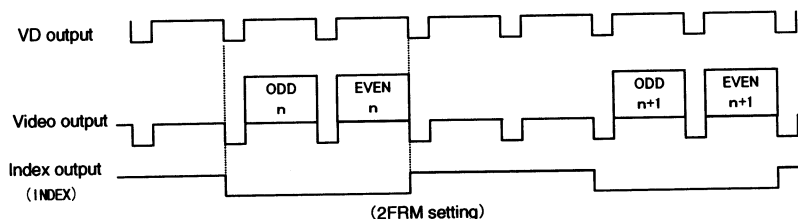



## 7. 5 EXT TRIG (External trigger)

Charge begins to accumulate after the trigger input, and 1 field or 1 frame images are output. There are three modes: 1PULSE SNR, 1PULSE SR and 2PULSE.

The RGB terminal trigger input and index output interface are as shown below.

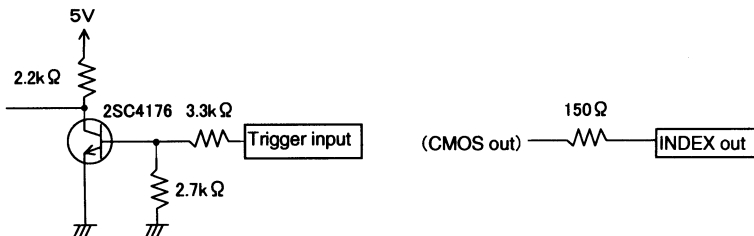

### (1) 1 PULSE SNR(1 Pulse Sync Non Reset)

Charge begins to accumulate after the trigger input to the RGB terminal, and 1 field images are output.

#### (a) Rising edge / Falling edge mode

The exposure time is set to 0.02 ms to 16 ms on the menu.

Trigger pulse level : (Low Level): Less than 0.5V , (High Level): 3.4V to 5V  
(RGB terminal)

Trigger pulse fetch timing : Rising edge / Falling edge selectable

Trigger pulse width : More than 2 μs

Trigger pulse interval : More than 50ms

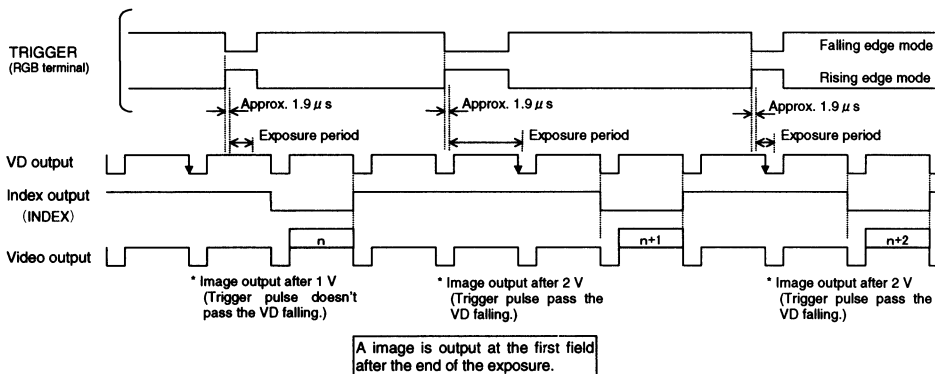



## (2) 1 PULSE SR(1 Pulse Sync Reset)

Charge begins to accumulate after the trigger input to the RGB terminal, the vertical sync signal is reset and field images are output.

### (a) Rising edge / Falling edge mode

The exposure time is set to 0.02 ms to 16 ms on the menu.

Trigger pulse level (RGB terminal)	: (Low Level) : Less than 0.5V , (High Level) : 3.4V to 5V
Trigger pulse fetch timing	: Rising edge / Falling edge selectable
Trigger pulse width	: More than $2\ \mu\text{s}$
Trigger pulse interval	: More than 33.5 ms

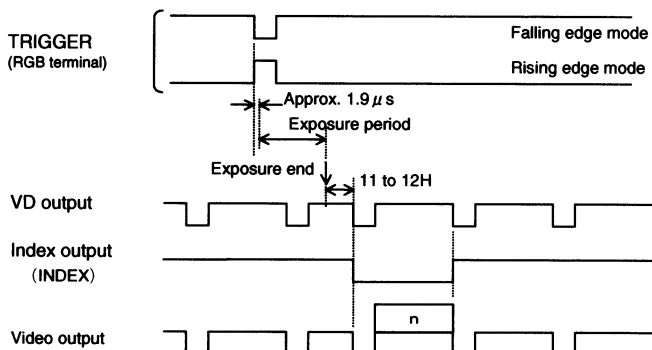

### (b) Width mode

Trigger pulse width	: More than $4\ \mu\text{s}$ Less than 255FRM
Trigger pulse interval	: 17.5ms (From exposure end to next exposure start.)

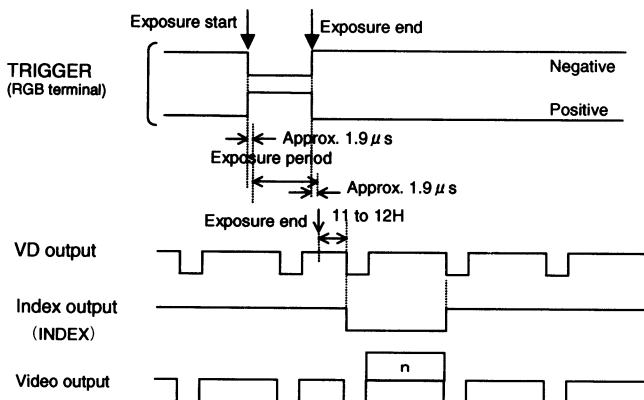

### **(3) 2PULSE**

Accumulation of charges is started and ended through the trigger pulse input to the RGB terminal, the vertical sync signal is reset and field images are output.

Trigger pulse level : (Low Level): Less than 0.5V , (High Level): 3.4V to 5V  
(RGB terminal)

Trigger pulse fetch timing : Rising edge / Falling edge / Pulse width selectable

•When the trigger pulse fetch timing is set to pulse width

Trigger pulse width : More than 16.7ms(FLD/FRM setting: FLD)  
More than 33.4ms(FLD/FRM setting: FRM)

Trigger pulse interval : More than 16.7ms(FLD/FRM setting: FLD)  
More than 33.4ms(FLD/FRM setting: FRM)

•When the trigger pulse fetch timing is set to rising edge or falling edge

Trigger pulse width : More than 2  $\mu$  s

Trigger pulse interval : More than 16.7ms(FLD/FRM setting: FLD)  
More than 33.4ms(FLD/FRM setting: FRM)

### (Frame storage period)

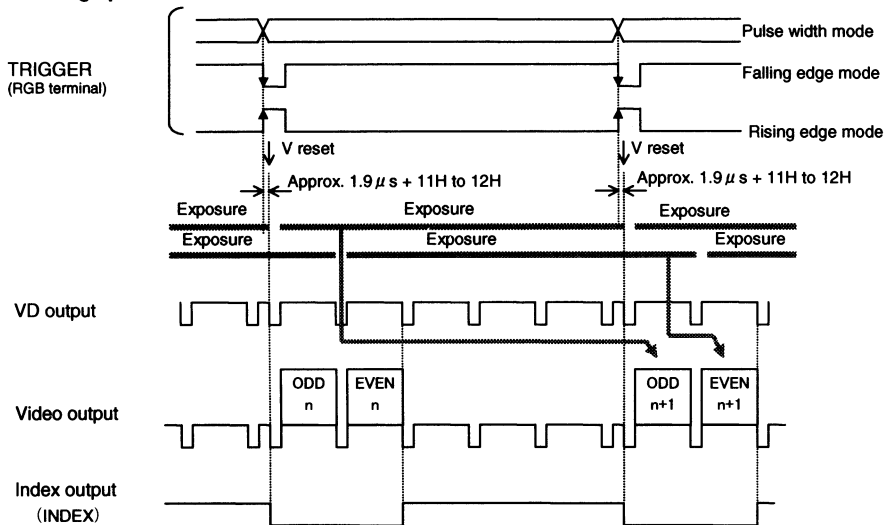

### (Field storage period)

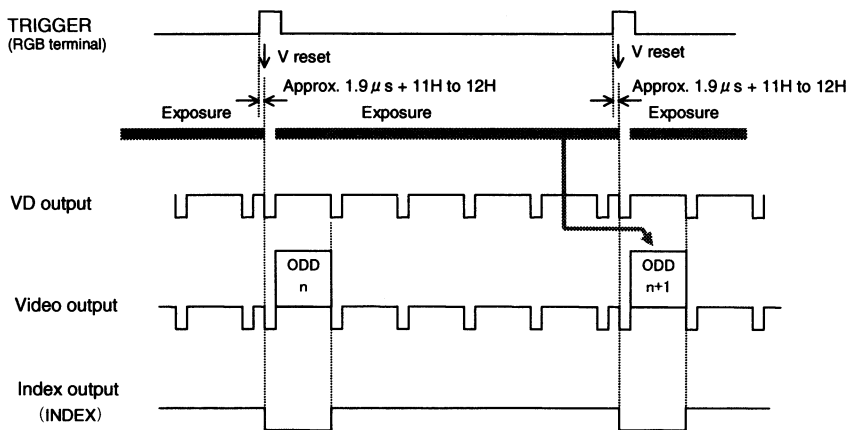

## 8. BEFORE MAKING A SERVICE CALL

Symptom	Items to be checked
No image	<ul style="list-style-type: none"> <li>· Is the power supplied correctly?</li> <li>· Is the lens iris adjusted correctly?</li> <li>· Are the cables connected correctly?</li> <li>· Is the shutter mode set correctly?</li> </ul>
Poor color	<ul style="list-style-type: none"> <li>· Is the monitor (TV) adjusted correctly?</li> <li>· Is the white balance of the camera adjusted correctly?</li> <li>· Is the illumination dark?</li> </ul>

## 9. SPECIFICATIONS

Power supply	DC12V $\pm$ 10%
Power consumption	Approx. 3.6W
Pick-up system	RGB, 3CCD, Micro prism system
Image sensor (Effective pixels)	1/3inch IT-CCD (Horizontal: 768pixels, Vertical: 494pixels)
Scanning system	2:1 interlace
Scan frequency	Horizontal: 15.734kHz, Vertical: 59.94Hz
Sync system	Internal/External(Automatic switching)
Horizontal resolution	570TV lines
Sensitivity	F8 standard (2000 lx, 3000K)
Minimum illumination	10 lx(F2.2, Sensitivity+18dB, 3000K)
SN ratio	64dB standard (G)
Lens mount	C mount(flange back: 17.526mm in-air)
Ambient temperature	32 to 104° F (0 to 40°C)
Ambient humidity	Less than 90%
Weight	Approx. 5.47oz (155g)
External dimension	1.73"(W) $\times$ 1.73"(H) $\times$ 3.07"(D) (44(W) $\times$ 44(H) $\times$ 78(D)mm) (except for protruded portion)
White balance	AWB (Automatic white balance), MANUAL (Manual)
Gain	MANUAL (Manual), OFF (0dB)
Output signal	RGB: 75 $\Omega$ unbalanced, D sub 15 pin connector
External sync input	HD or VD: 2-5V(p-p) Negative
Sync signal output	SYNC: 2.0V $\pm$ 1V(p-p) 75 $\Omega$ unbalanced HD, VD, INDEX: 5V <sup>+0.5</sup> <sub>-1.0</sub> V(p-p), Negative, Load impedance: More than 10k $\Omega$
External trigger input	TRIGGER: Low level: Less than 0.4V, High level: 3.4-5V 1 Pulse: Positive/Negative/Width selectable 2 Pulse: Positive/Negative/Width selectable
Interface	Serial data interface (RS-232C)
Optional parts	EXC-TF05B(RGB cable), etc

● Design and specifications are subject to change without notice.

# 10. EXTERNAL APPEARANCE DIAGRAM

Unit : mm [inch]

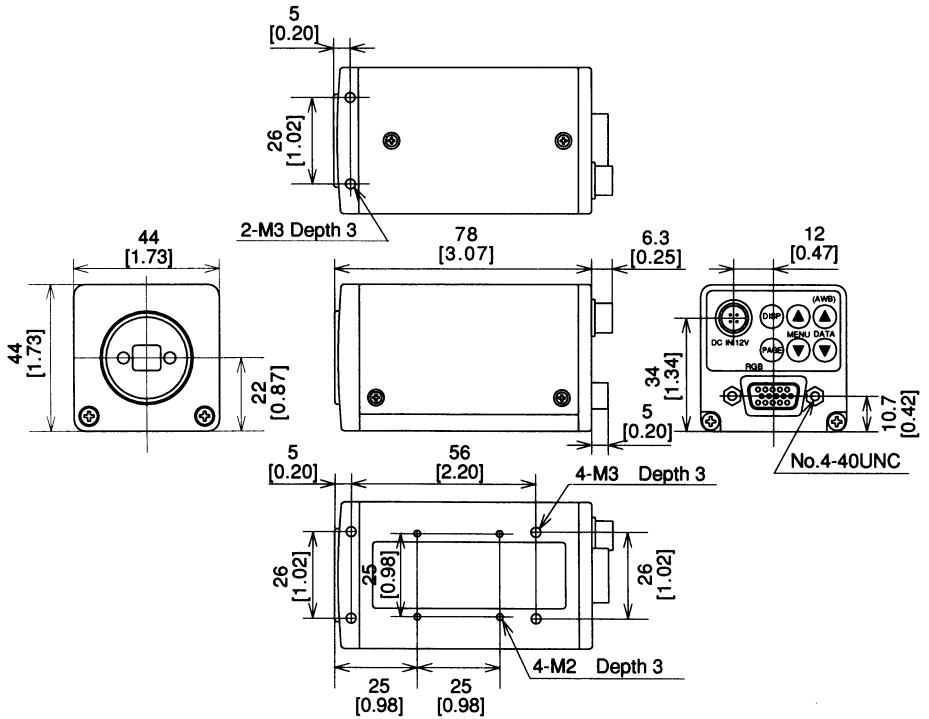

## Free Manuals Download Website

<http://myh66.com>

<http://usermanuals.us>

<http://www.somanuals.com>

<http://www.4manuals.cc>

<http://www.manual-lib.com>

<http://www.404manual.com>

<http://www.luxmanual.com>

<http://aubethermostatmanual.com>

Golf course search by state

<http://golfingnear.com>

Email search by domain

<http://emailbydomain.com>

Auto manuals search

<http://auto.somanuals.com>

TV manuals search

<http://tv.somanuals.com>